

KONE SUSPENSION

D41025-

base number Finish
Options

- To build a product code in our configurator select the specify button on the base model # product page
- To build a manual product code on this datasheet choose from the options listed below in blue font and add the suffix to the base model #

GENERAL

Series: Kone
Partner: Icone
Division: Design
Installation: Suspension
Product Type: Pendant
Mounting Location: Ceiling
Light Distribution: Direct

PHYSICAL

Shape: Cylinder
Diameter (mm): 50
Diameter (in): 1 ¹⁵/₁₆
Height (mm): 420
Height (in): 16 ⁹/₁₆
Max. Overall Height (mm): 2500
Max. Overall Height (in): 98 ⁷/₁₆
Fixture Finish: WHI / TWH
Fixture Material: Aluminum

ELECTRICAL

Lamp Type: LED
Total Output Wattage (W): 4.5
Dimming: Electronic Low Voltage Dimming
Input Voltage (V): 120Vac Direct Line

LED

Color Temperature (°K): 3000
Nominal Lumen (lm): 350
CRI: >90 CRI
Lamp Life (hrs): 50000

OPTICAL

RATINGS AND CERTIFICATIONS

Certified By: Certified for North American Standards
IP rating: IP20

PROJECT	_____
TYPE	_____
SPECIFIER	_____
QUANTITY	_____
DATE	_____

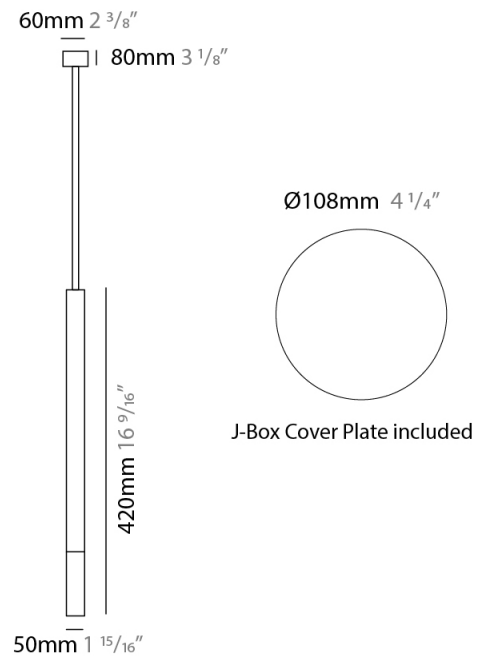

KONE SUSPENSION

D41025-

PROJECT
TYPE
SPECIFIER
QUANTITY
DATE

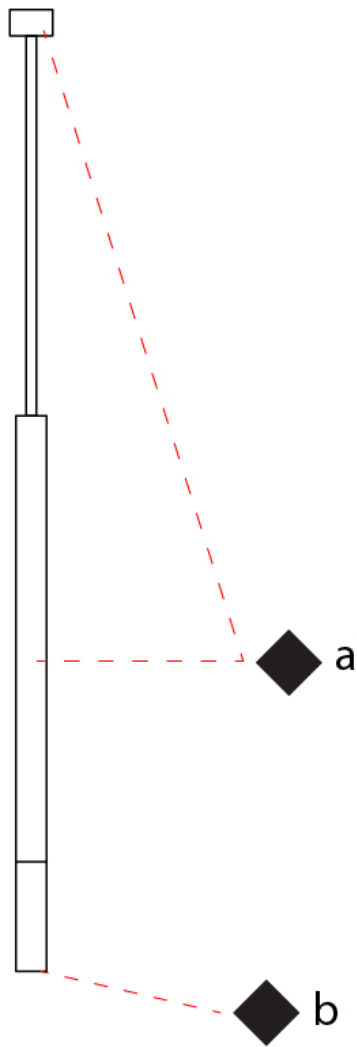

D

KONE SUSPENSION

D41025- : D41025-WHI

base number

- To build a product code in our configurator select the specify button on the base model # product page
- To build a manual product code on this datasheet choose from the options listed below in blue font and add the suffix to the base model #

GENERAL

Series: Kone
 Partner: Icone
 Division: Design
 Installation: Suspension
 Product Type: Pendant
 Mounting Location: Ceiling
 Light Distribution: Direct

PHYSICAL

Shape: Cylinder
 Diameter (mm): 50
 Diameter (in): 1 ¹⁵/₁₆
 Height (mm): 420
 Height (in): 16 ⁹/₁₆
 Max. Overall Height (mm): 2500
 Max. Overall Height (in): 98 ⁷/₁₆
 Weight (kg): 2.5
 Weight (lbs): 5.499
 Holder Finish: White/White
 Fixture Material: Aluminum

ELECTRICAL

Lamp Type: LED
 Total Output Wattage (W): 4.5
 Dimming: Electronic Low Voltage Dimming
 Input Voltage (V): 120Vac Direct Line

LED

Color Temperature (°K): 3000
 Nominal Lumen (lm): 350
 CRI: >90 CRI
 Lamp Life (hrs): 50000

OPTICAL

RATINGS AND CERTIFICATIONS

Certified By: CSA Certified to UL and CSA Standards
 IP rating: IP20

PROJECT	
TYPE	
SPECIFIER	
QUANTITY	
DATE	

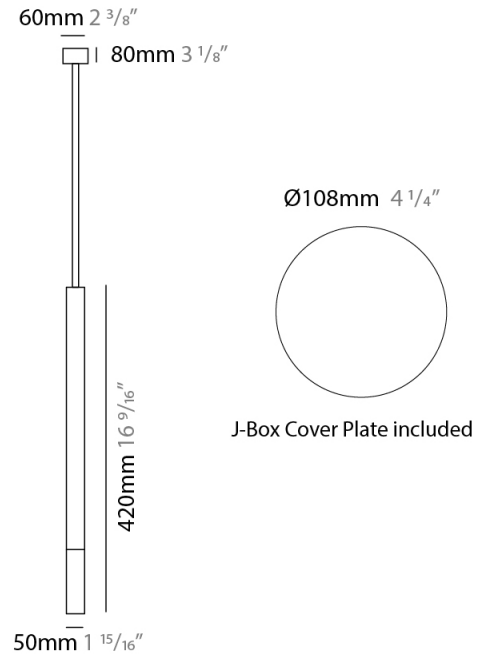
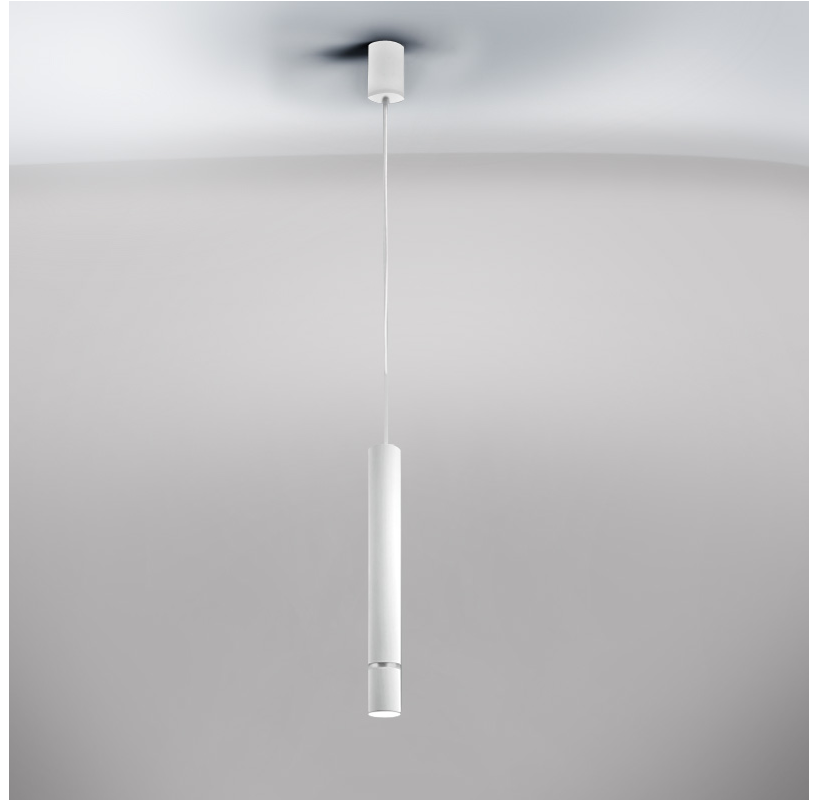

KONE SUSPENSION

D41025- : D41025-WHI

PROJECT _____

TYPE _____

SPECIFIER _____

QUANTITY _____

DATE _____

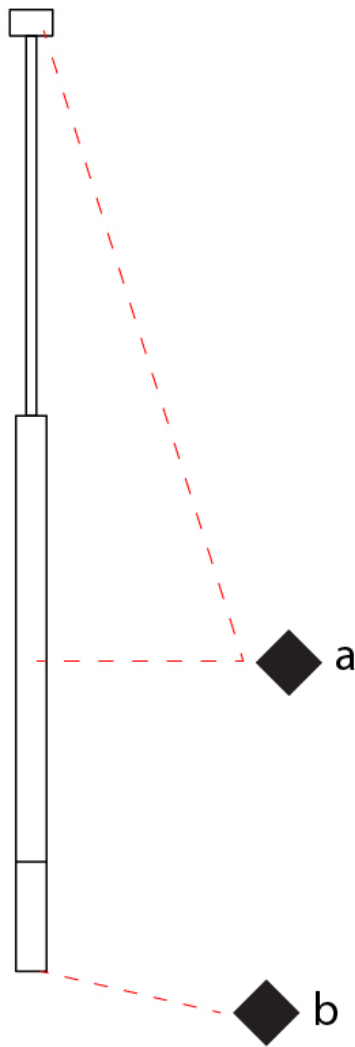

D

PROJECT
TYPE
SPECIFIER
QUANTITY
DATE

KONE SURFACE

D42016-

base number Finish
Options

- To build a product code in our configurator select the specify button on the base model # product page
- To build a manual product code on this datasheet choose from the options listed below in blue font and add the suffix to the base model #

GENERAL

Series: Kone
 Partner: Icone
 Division: Design
 Installation: Surface
 Product Type: Ceiling Surface
 Mounting Location: Ceiling
 Light Distribution: Direct

PHYSICAL

Aperture Sizes - Downlights: 1"
 Shape: Cylinder
 Diameter (mm): 50
 Diameter (in): 1 ¹⁵/₁₆
 Height (mm): 70
 Height (in): 2 ³/₄
 Fixture Finish: WHI / TWH / WGF / BGL
 Fixture Material: Aluminum

ELECTRICAL

Lamp Type: LED
 Total Output Wattage (W): 4.5
 Dimming: Electronic Low Voltage Dimming
 Input Voltage (V): 120Vac Direct Line

LED

Color Temperature (°K): 3000
 Nominal Lumen (lm): 350
 CRI: >90 CRI
 Lamp Life (hrs): 50000

OPTICAL

RATINGS AND CERTIFICATIONS

Certified By: Certified for North American Standards
 IP rating: IP20

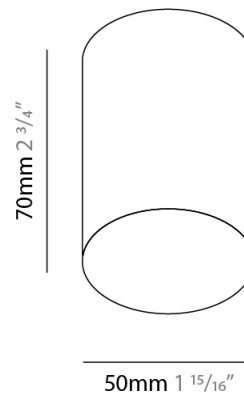

D42016-

PROJECT

TYPE

SPECIFIER

QUANTITY

DATE

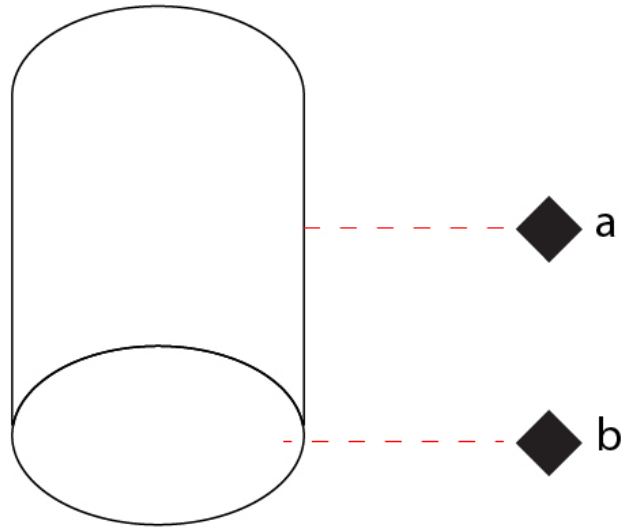

D

PROJECT _____

TYPE _____

SPECIFIER _____

QUANTITY _____

DATE _____

Fixture Finish

Titanium/White - TWH

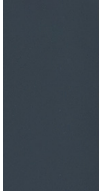

White - WHI



White/Gold Leaf - WGF

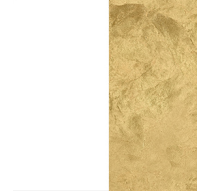

Black/Gold Leaf - BGL



Holder Finish

Digital: Not all screens are calibrated the same, and therefore, colors will appear differently between screens.

Physical: When texture is involved, there will be variations in color, character and tone within a product series and between product families.



PROJECT	
TYPE	
SPECIFIER	
QUANTITY	
DATE	

LEGEND

floor-mounted	pivotal	special LED (upon request) RGB, RGBW, tunable, gold+, meat+, art+, fashion+
wall and ceiling: recessed and surface mounted	rotating	warm dim / natural dimming LED
ceiling-mounted and wall-mounted	illuminate tilted	rechargeable battery powered
wall-mounted	color of suspension cable	fixture with natural vivid LED (upon request)
omni-directional light distribution	length of suspension cable	color rendering index
direct light distribution	reflector degree selection	color temperature
direct/indirect light distribution	super spot	lumen (luminous flux)
indirect light distribution	lens	efficacy (lumens per watt)
asymmetric light distribution	lens pack	Unified Glare Rating (UGR) range from 5-40
aura light distribution	shine ring	marine grade (AISI 316 stainless steel)
round wall or ceiling cut-out	integrated shine ring with diffuser	walk on
square wall or ceiling cut-out	free individual colors 01-29	drive on
the supplied jig specifies the cutout dimensions	individual colors: 00 (free of charge), 01-25 (extra charge)	Dark Sky Compliance
minimum distance (meters) lamp - object	luminaire part to be colored (F1)	Americans with Disabilities Act (less than 4" off the wall located between 27"-84" from floor)
recessed depth	luminaire part to be colored (F2)	lamp protected against explosion
ceiling thickness in mm	luminaire part to be colored (F3)	blown glass using traditional methods by master glass blower
ceiling thickness selection	luminaire part to be colored (F4)	acoustic material
dimmable DP (phase), DV (0-10V), DD (dali), DS (step-dim)	luminaire part to be colored (F5)	protection class I, protection insulation
included or excluded LED driver/transformer/control gear	color of 3-circuit adaptor	protection class II, protection insulation
separately switchable	indirect diffuser	ETL Certified to UL and CSA Standards
sensor	direct diffuser	UL Certified to UL and CSA Standards
remote control	ball-proof (upon request)	CSA Certified to UL and CSA Standards
available upon request	accessory	Certified for North American Standards

IP RATING

IP20	protected against ingress of solid bodies greater than 12.5mm (finger)
IP33	protected against ingress of solid bodies greater than 2.5mm protected against sprays of water up to 60 degrees from the vertical (rain)
IP40	protected against ingress of solid bodies greater than 1mm (wire) no protection against the ingress of moisture
IP43	protected against ingress of solid bodies greater than 1mm (wire) protected against sprays of water up to 60 degrees from the vertical (rain)
IP44	protected against ingress of solid bodies greater than 1mm (wire) protected against water splashed from all directions
IP54	protected against limited ingress of dust (wet rooms/covered outdoor areas) protected against water splashed from all directions
IP65	protected against ingress of dust protected against jets of water
IP66	protected against ingress of dust protected against powerful jets of water or heavy seas
IP67	protected against ingress of dust protected against immersion of water between 15cm - 1m for 30 minutes
IP68	protected against ingress of dust protected against immersion of water under pressure for long periods

IK RATING

IK01	protected against 0.14 joules impact (equivalent to 0.25kg mass dropped from 56mm above the surface)
IK02	protected against 0.2 joules impact (equivalent to 0.25kg mass dropped from 80mm above the surface)
IK03	protected against 0.35 joules impact (equivalent to 0.25kg mass dropped from 140mm above the surface)
IK04	protected against 0.5 joules impact (equivalent to 0.25kg mass dropped from 200mm above the surface)
IK05	protected against 0.7 joules impact (equivalent to 0.25kg mass dropped from 280mm above the surface)
IK06	protected against 1 joules impact (equivalent to 0.25kg mass dropped from 400mm above the surface)
IK07	protected against 2 joules impact (equivalent to 0.5kg mass dropped from 400mm above the surface)
IK08	protected against 5 joules impact (equivalent to 1.7kg mass dropped from 300mm above the surface)
IK09	protected against 10 joules impact (equivalent to 5.0kg mass dropped from 200mm above the surface)
IK10	protected against 20 joules impact (equivalent to 5.0kg mass dropped from 400mm above the surface)