

KONE SUSPENSION

D41024-

base number Finish
Options

- To build a product code in our configurator select the specify button on the base model # product page
- To build a manual product code on this datasheet choose from the options listed below in blue font and add the suffix to the base model #

GENERAL

Series: Kone
Brand: Icone
Division: Design
Mounting Type: Suspension
Mounting Location: Ceiling
Subcategory: Pendant

PHYSICAL

Shape: Cylinder
Diameter (mm): 70
Diameter (in): 2 3/4
Height (mm): 420
Height (in): 16 9/16
Max. Overall Height (mm): 2500
Max. Overall Height (in): 98 7/16
Light Distribution: Direct
Fixture Finish: WHI / TIM_WHI / BAL_WHI
Fixture Material: Aluminum

ELECTRICAL

Lamp Type: LED
Total Output Wattage (W): 10
Dimming: Electronic Low Voltage Dimming
Input Voltage (V): 120Vac Direct Line

LED

Color Temperature (°K): 3000
Nominal Lumen (lm): 700
CRI: >90 CRI
Lamp Life (hrs): 50000

OPTICAL

RATINGS AND CERTIFICATIONS

Certified By: Certified for North American Standards
IP rating: IP20

PROJECT	_____
TYPE	_____
SPECIFIER	_____
QUANTITY	_____
DATE	_____

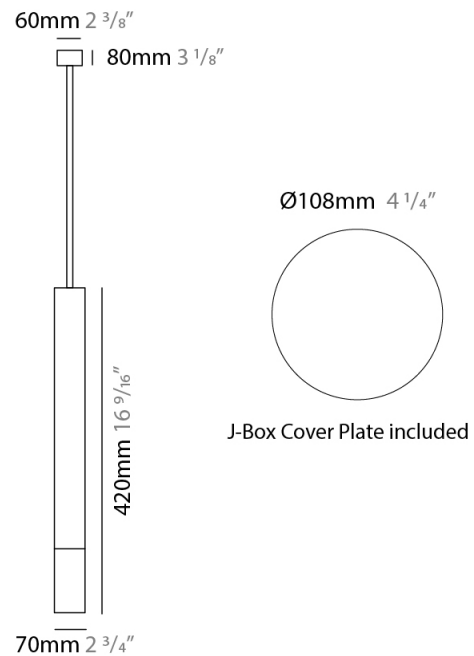

KONE SUSPENSION

D41024-

PROJECT _____

TYPE _____

SPECIFIER _____

QUANTITY _____

DATE _____

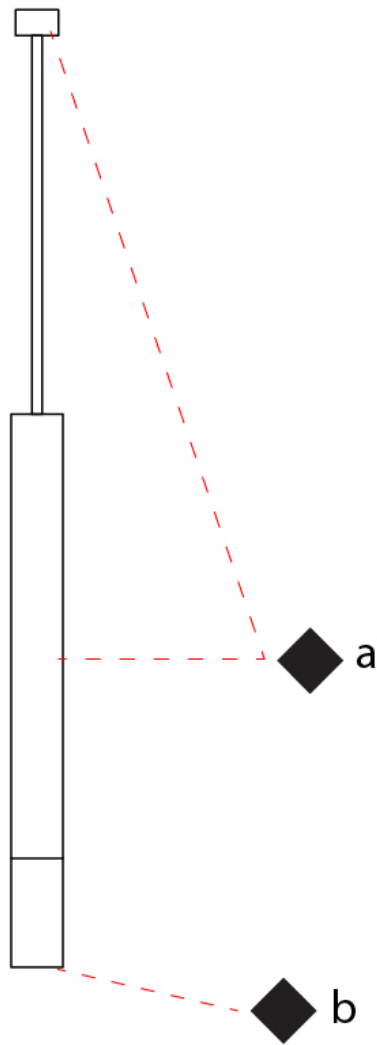

D

KONE SUSPENSION

D41025-

base number Finish
Options

- To build a product code in our configurator select the specify button on the base model # product page
- To build a manual product code on this datasheet choose from the options listed below in blue font and add the suffix to the base model #

GENERAL

Series: Kone
 Brand: Icone
 Division: Design
 Mounting Type: Suspension
 Mounting Location: Ceiling
 Subcategory: Pendant

PHYSICAL

Shape: Cylinder
 Diameter (mm): 50
 Diameter (in): 1 ¹⁵/₁₆
 Height (mm): 420
 Height (in): 16 ⁹/₁₆
 Max. Overall Height (mm): 2500
 Max. Overall Height (in): 98 ⁷/₁₆
 Light Distribution: Direct
 Fixture Finish: WHI / TIM_WHI / BAL_WHI
 Fixture Material: Aluminum

ELECTRICAL

Lamp Type: LED
 Total Output Wattage (W): 4.5
 Dimming: Electronic Low Voltage Dimming
 Input Voltage (V): 120Vac Direct Line

LED

Color Temperature (°K): 3000
 Nominal Lumen (lm): 350
 CRI: >90 CRI
 Lamp Life (hrs): 50000

OPTICAL

RATINGS AND CERTIFICATIONS

Certified By: Certified for North American Standards
 IP rating: IP20

PROJECT	_____
TYPE	_____
SPECIFIER	_____
QUANTITY	_____
DATE	_____

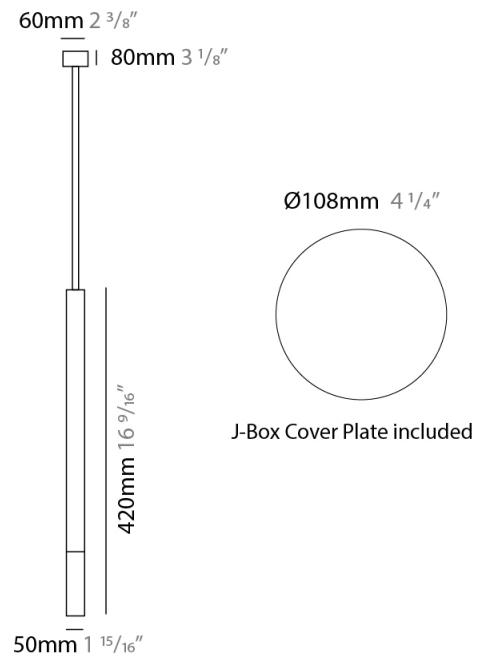

KONE SUSPENSION

D41025-

PROJECT _____

TYPE _____

SPECIFIER _____

QUANTITY _____

DATE _____

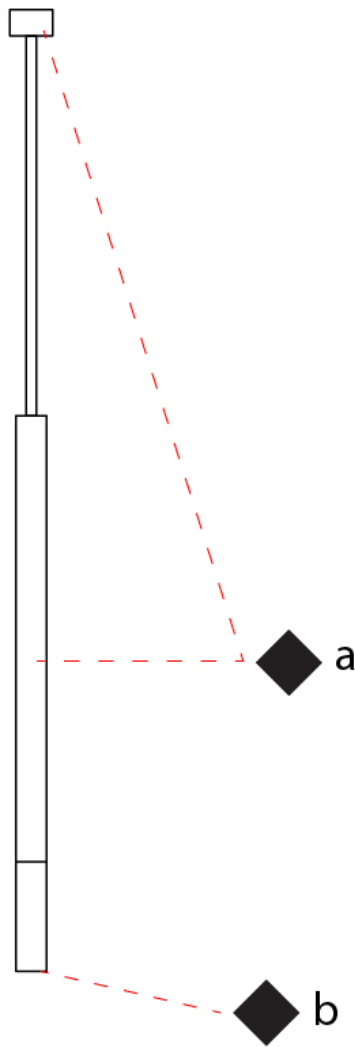

D

PROJECT _____
TYPE _____
SPECIFIER _____
QUANTITY _____
DATE _____

KONE SURFACE

D42016-

base number _____
Finish _____
Options _____

1. To build a product code in our configurator select the specify button on the base model # product page
2. To build a manual product code on this datasheet choose from the options listed below in blue font and add the suffix to the base model #

GENERAL

Series: Kone _____
Brand: Icone _____
Division: Design _____
Mounting Type: Surface _____
Mounting Location: Ceiling _____
Subcategory: Spots _____

PHYSICAL

Shape: Cylinder _____
Diameter (mm): 50 _____
Diameter (in): 1 ¹⁵/₁₆ _____
Height (mm): 70 _____
Height (in): 2 ³/₄ _____
Light Distribution: Direct _____
Fixture Finish: WHI / TIM_WHI / BAL_WHI / TIM_SLF / CHO_GLF _____
Fixture Material: Aluminum _____

ELECTRICAL

Lamp Type: LED _____
Total Output Wattage (W): 4.5 _____
Dimming: Electronic Low Voltage Dimming _____
Input Voltage (V): 120Vac Direct Line _____

LED

Color Temperature (°K): 3000 _____
Nominal Lumen (lm): 350 _____
CRI: >90 CRI _____
Lamp Life (hrs): 50000 _____

OPTICAL

RATINGS AND CERTIFICATIONS

Certified By: Certified for North American Standards _____
IP rating: IP20 _____

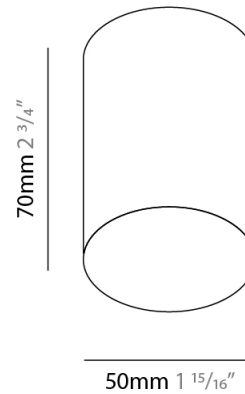

D42016-

PROJECT

TYPE

SPECIFIER

QUANTITY

DATE

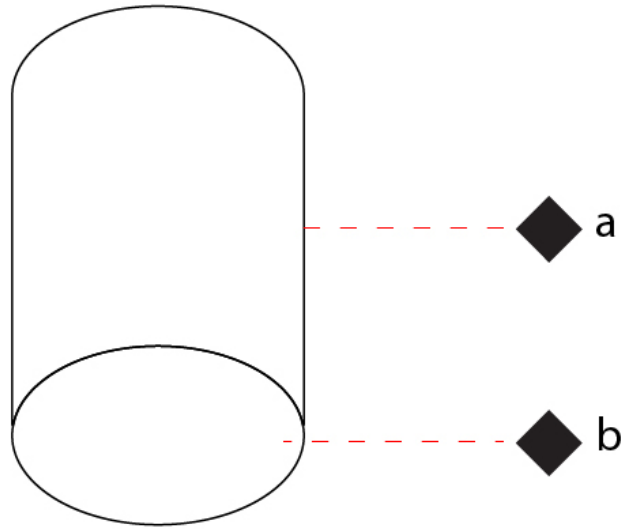

D

PROJECT
TYPE
SPECIFIER
QUANTITY
DATE

KONE SURFACE

D42017-

base number Finish
Options

- To build a product code in our configurator select the specify button on the base model # product page
- To build a manual product code on this datasheet choose from the options listed below in blue font and add the suffix to the base model #

GENERAL

Series: Kone
 Brand: Icone
 Division: Design
 Mounting Type: Surface
 Mounting Location: Ceiling
 Subcategory: Spots

PHYSICAL

Shape: Cylinder
 Diameter (mm): 70
 Diameter (in): 2 3/4
 Height (mm): 70
 Height (in): 2 3/4
 Light Distribution: Direct
 Fixture Finish: WHI / TIM_WHI / BAL_WHI / TIM_SLF / CHO_GLF
 Fixture Material: Aluminum

ELECTRICAL

Lamp Type: LED
 Total Output Wattage (W): 10
 Dimming: Electronic Low Voltage Dimming
 Input Voltage (V): 120Vac Direct Line

LED

Color Temperature (°K): 3000
 Nominal Lumen (lm): 700
 CRI: >90 CRI
 Lamp Life (hrs): 50000

OPTICAL

RATINGS AND CERTIFICATIONS

Certified By: Certified for North American Standards
 IP rating: IP20

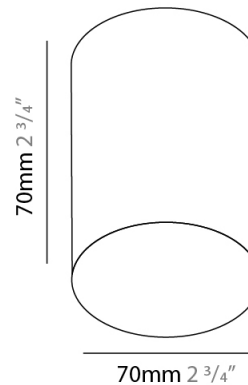

D42017-

PROJECT

TYPE

SPECIFIER

QUANTITY

DATE

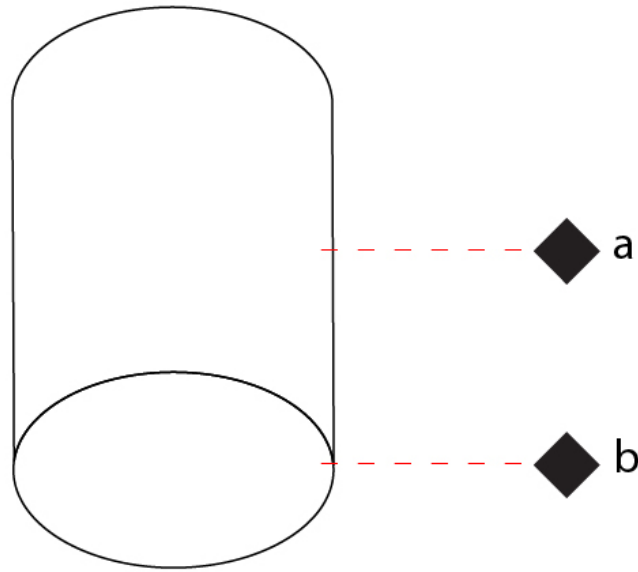

PROJECT
TYPE
SPECIFIER
QUANTITY
DATE

KONE SURFACE

D42018-

base number Finish
Options

- To build a product code in our configurator select the specify button on the base model # product page
- To build a manual product code on this datasheet choose from the options listed below in blue font and add the suffix to the base model #

GENERAL

Series: Kone
 Brand: Icone
 Division: Design
 Mounting Type: Surface
 Mounting Location: Ceiling
 Subcategory: Spots

PHYSICAL

Shape: Cylinder
 Diameter (mm): 90
 Diameter (in): 3 ⁹/₁₆
 Height (mm): 100
 Height (in): 3 ¹⁵/₁₆
 Light Distribution: Direct
 Fixture Finish: WHI / TIM_WHI / BAL_WHI / TIM_SLF / CHO_GLF
 Fixture Material: Aluminum

ELECTRICAL

Lamp Type: LED
 Total Output Wattage (W): 17
 Dimming: Electronic Low Voltage Dimming
 Input Voltage (V): 120Vac Direct Line

LED

Color Temperature (°K): 3000
 Nominal Lumen (lm): 1300
 CRI: >90 CRI
 Lamp Life (hrs): 50000

OPTICAL

RATINGS AND CERTIFICATIONS

Certified By: Certified for North American Standards
 IP rating: IP20

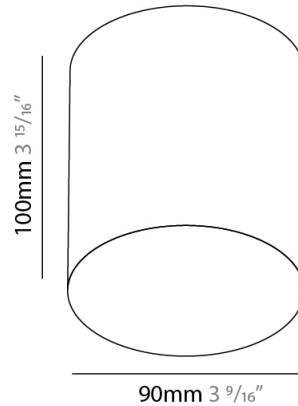

D42018-

PROJECT

TYPE

SPECIFIER

QUANTITY

DATE

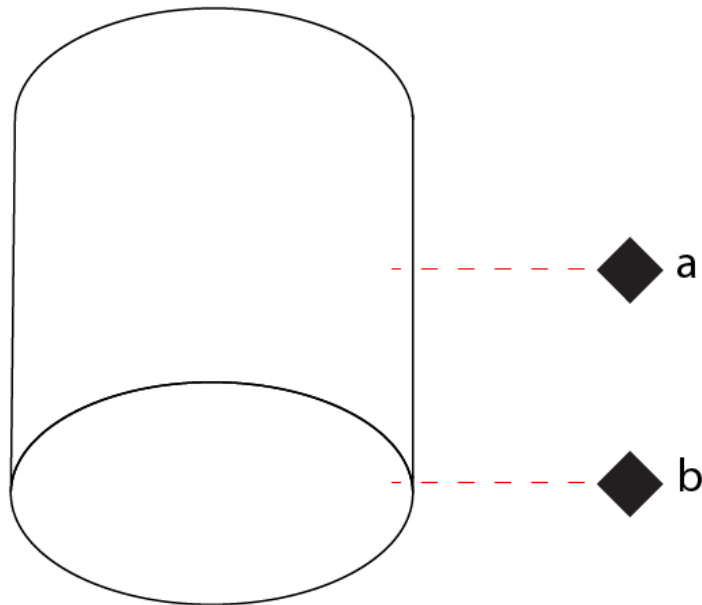

D

KONE SURFACE

D43010-

base number Finish
Options

- To build a product code in our configurator select the specify button on the base model # product page
- To build a manual product code on this datasheet choose from the options listed below in blue font and add the suffix to the base model #

GENERAL

Series: Kone
 Brand: Icone
 Division: Design
 Mounting Type: Surface
 Mounting Location: Wall
 Subcategory: Spots

PHYSICAL

Shape: Cylinder
 Diameter (mm): 100
 Diameter (in): 3 ¹⁵/₁₆
 Height (mm): 168
 Height (in): 6 ⁵/₈
 Extension (mm): 120
 Extension (in): 4 ³/₄
 Light Distribution: Direct / Indirect
 Fixture Finish: WHI / TIM_WHI / BAL_WHI
 Fixture Material: Aluminum

ELECTRICAL

Lamp Type: LED
 Total Output Wattage (W): 35
 Dimming: Electronic Low Voltage Dimming
 Input Voltage (V): 120Vac Direct Line

LED

Color Temperature (°K): 3000
 Nominal Lumen (lm): 2800
 CRI: >90 CRI
 Lamp Life (hrs): 50000

OPTICAL

RATINGS AND CERTIFICATIONS

Certified By: Certified for North American Standards
 IP rating: IP20

PROJECT	_____
TYPE	_____
SPECIFIER	_____
QUANTITY	_____
DATE	_____

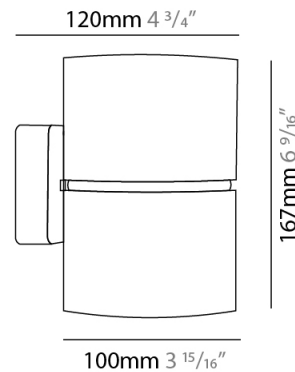

KONE SURFACE

D43010-

PROJECT _____

TYPE _____

SPECIFIER _____

QUANTITY _____

DATE _____

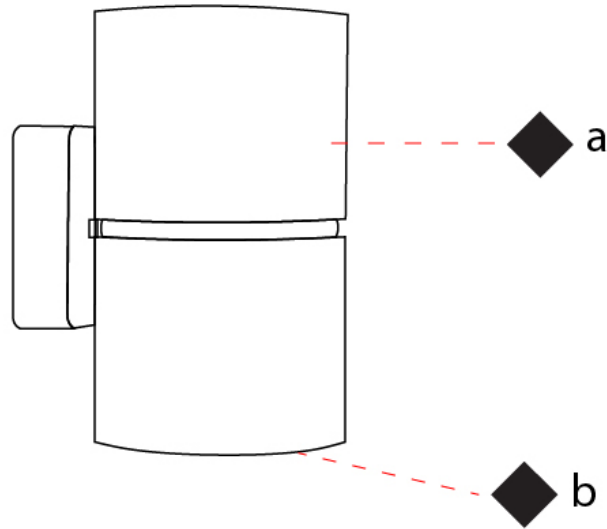

D

PROJECT	_____
TYPE	_____
SPECIFIER	_____
QUANTITY	_____
DATE	_____

KONE SURFACE

D43037-

base number Finish
Options

- To build a product code in our configurator select the specify button on the base model # product page
- To build a manual product code on this datasheet choose from the options listed below in blue font and add the suffix to the base model #

GENERAL

Series: Kone _____
 Brand: Icone _____
 Division: Design _____
 Mounting Type: Surface _____
 Mounting Location: Wall _____
 Subcategory: Spots _____

PHYSICAL

Shape: Cylinder _____
 Diameter (mm): 70 _____
 Diameter (in): 2 ¾ _____
 Height (mm): 133 _____
 Height (in): 5 ¼ _____
 Light Distribution: Direct / Indirect _____
 Fixture Finish: WHI / TIM_WHI / BAL_WHI _____
 Fixture Material: Aluminum _____

ELECTRICAL

Lamp Type: LED _____
 Total Output Wattage (W): 17 _____
 Dimming: Electronic Low Voltage Dimming _____
 Input Voltage (V): 120Vac Direct Line _____

LED

Color Temperature (°K): 3000 _____
 Nominal Lumen (lm): 1400 _____
 CRI: >90 CRI _____
 Lamp Life (hrs): 50000 _____

OPTICAL

RATINGS AND CERTIFICATIONS

Certified By: Certified for North American Standards _____
 IP rating: IP20 _____

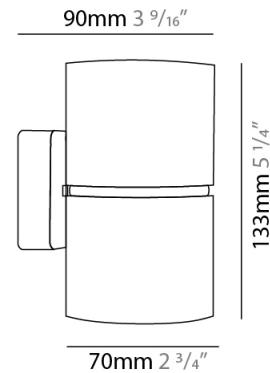

KONE SURFACE

D43037-

PROJECT

TYPE

SPECIFIER

QUANTITY

DATE

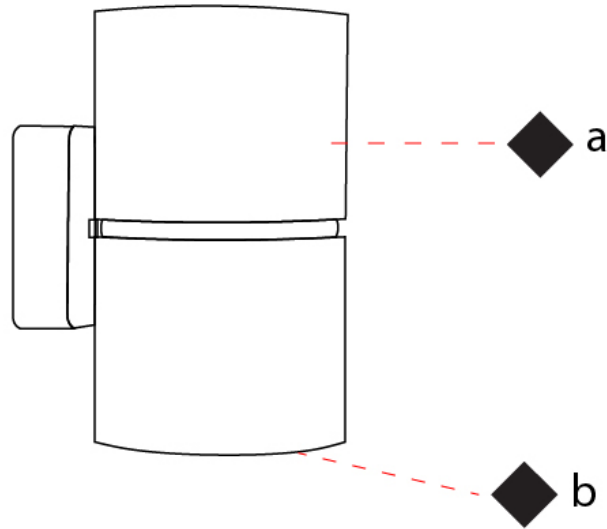

D

PROJECT	_____
TYPE	_____
SPECIFIER	_____
QUANTITY	_____
DATE	_____

Fixture Finish

White - WHI

Titanium and White - TIM_WHI



Brushed Aluminum And White - BAL_WHI



Titanium and Silver Leaf - TIM_SLF

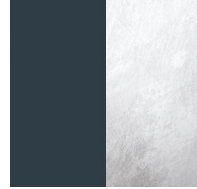

Chocolate and Gold Leaf - CHO_GLF



Digital: Not all screens are calibrated the same, and therefore, colors will appear differently between screens.











Physical: When texture is involved, there will be variations in color, character and tone within a product series and between product families.













LEGEND

 floor-mounted	 pivotable	 special LED (upon request) RGB, RGBW, tunable, gold+, meat+, art+, fashion+
 wall and ceiling: recessed and surface mounted	 rotating	 warm dim / natural dimming LED
 ceiling-mounted and wall-mounted	 illuminate tilted	 rechargeable battery powered
 wall-mounted	 color of suspension cable	 fixture with natural vivid LED (upon request)
 omni-directional light distribution	 length of suspension cable	 color rendering index
 direct light distribution	 reflector degree selection	 color temperature
 direct/indirect light distribution	 super spot	 lumen (luminous flux)
 indirect light distribution	 lens	 efficacy (lumens per watt)
 asymmetric light distribution	 lens pack	 Unified Glare Rating (UGR) range from 5-40
 aura light distribution	 shine ring	 marine grade (AISI 316 stainless steel)
 round wall or ceiling cut-out	 integrated shine ring with diffuser	 walk on
 square wall or ceiling cut-out	 free individual colors 01-29	 drive on
 the supplied jig specifies the cutout dimensions	 individual colors: 00 (free of charge), 01-25 (extra charge)	 Dark Sky Compliance
 minimum distance (meters) lamp - object	 luminaire part to be colored (F1)	 Americans with Disabilities Act (less than 4" off the wall located between 27"-84" from floor)
 recessed depth	 luminaire part to be colored (F2)	 lamp protected against explosion
 ceiling thickness in mm	 luminaire part to be colored (F3)	 blown glass using traditional methods by master glass blower
 ceiling thickness selection	 luminaire part to be colored (F4)	 acoustic material
 dimmable DP (phase), DV (0-10V), DD (dali), DS (step-dim)	 luminaire part to be colored (F5)	 protection class I, protection insulation
 included or excluded LED driver/transformer/control gear	 color of 3-circuit adaptor	 protection class II, protection insulation
 separately switchable	 indirect diffuser	 ETL Certified to UL and CSA Standards
 sensor	 direct diffuser	 UL Certified to UL and CSA Standards
 remote control	 ball-proof (upon request)	 CSA Certified to UL and CSA Standards
 available upon request	 accessory	 Certified for North American Standards

IP RATING

 IP20	protected against ingress of solid bodies greater than 12.5mm (finger)
 IP33	protected against ingress of solid bodies greater than 2.5mm protected against sprays of water up to 60 degrees from the vertical (rain)
 IP40	protected against ingress of solid bodies greater than 1mm (wire) no protection against the ingress of moisture
 IP43	protected against ingress of solid bodies greater than 1mm (wire) protected against sprays of water up to 60 degrees from the vertical (rain)
 IP44	protected against ingress of solid bodies greater than 1mm (wire) protected against water splashed from all directions
 IP54	protected against limited ingress of dust (wet rooms/covered outdoor areas) protected against water splashed from all directions
 IP65	protected against ingress of dust protected against jets of water
 IP66	protected against ingress of dust protected against powerful jets of water or heavy seas
 IP67	protected against ingress of dust protected against immersion of water between 15cm - 1m for 30 minutes
 IP68	protected against ingress of dust protected against immersion of water under pressure for long periods

IK RATING

 IK01	protected against 0.14 joules impact (equivalent to 0.25kg mass dropped from 56mm above the surface)
 IK02	protected against 0.2 joules impact (equivalent to 0.25kg mass dropped from 80mm above the surface)
 IK03	protected against 0.35 joules impact (equivalent to 0.25kg mass dropped from 140mm above the surface)
 IK04	protected against 0.5 joules impact (equivalent to 0.25kg mass dropped from 200mm above the surface)
 IK05	protected against 0.7 joules impact (equivalent to 0.25kg mass dropped from 280mm above the surface)
 IK06	protected against 1 joules impact (equivalent to 0.25kg mass dropped from 400mm above the surface)
 IK07	protected against 2 joules impact (equivalent to 0.5kg mass dropped from 400mm above the surface)
 IK08	protected against 5 joules impact (equivalent to 1.7kg mass dropped from 300mm above the surface)
 IK09	protected against 10 joules impact (equivalent to 5.0kg mass dropped from 200mm above the surface)
 IK10	protected against 20 joules impact (equivalent to 5.0kg mass dropped from 400mm above the surface)