

## MARIOLA SUSPENSION

**E111198-** -

base number      Finish Options      Finish Options

- To build a product code in our configurator select the specify button on the base model # product page
- To build a manual product code on this datasheet choose from the options listed below in blue font and add the suffix to the base model #

### GENERAL

Series: Mariola  
 Partner: Ole  
 Division: Exterior  
 Installation: Suspension  
 Product Type: Pendant  
 Mounting Location: Ceiling

### PHYSICAL

Shape: Drum  
 Diameter (mm): 500  
 Diameter (in): 19 11/16  
 Height (mm): 250  
 Height (in): 9 13/16  
 Max. Overall Height (mm): 2250  
 Max. Overall Height (in): 89 9/16  
 Fixture Finish: BEI / BLK / BLU / COG / DGN / GRY / MRN / MOC / MUS / OLV / SIL / STN / TER / WHI  
 Holder Finish: MBK  
 Accent Finish: WHI / GSD  
 Fixture Material: Fabric Cord / Metal  
 Primary Material: Fabric - Recycled  
 Cable Details: 2000mm/78 3/4" Transparent Cable  
 Upon Request: Matte White Holder

### ELECTRICAL

Number of Lamps: 1  
 Lamp Type: LED Retrofit  
 Bulb Included: Bulb Not Included  
 Max. Wattage Per Lamp (W): 15  
 Lamp Base: E26  
 Input Voltage (V): 120

### LED

### OPTICAL

### RATINGS AND CERTIFICATIONS

Certified By: Certified for North American Standards  
 IP rating: IP66

PROJECT
TYPE
SPECIFIER
QUANTITY
DATE

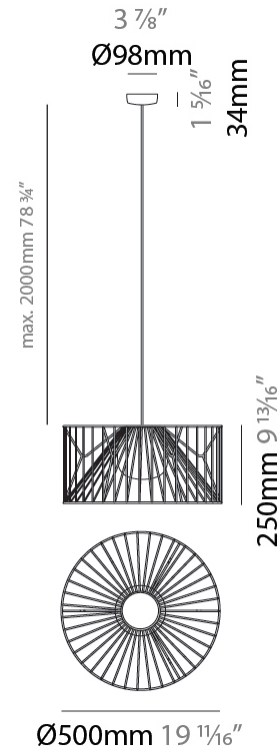

## MARIOLA SUSPENSION

E111198-

PROJECT

TYPE

SPECIFIER

QUANTITY

DATE

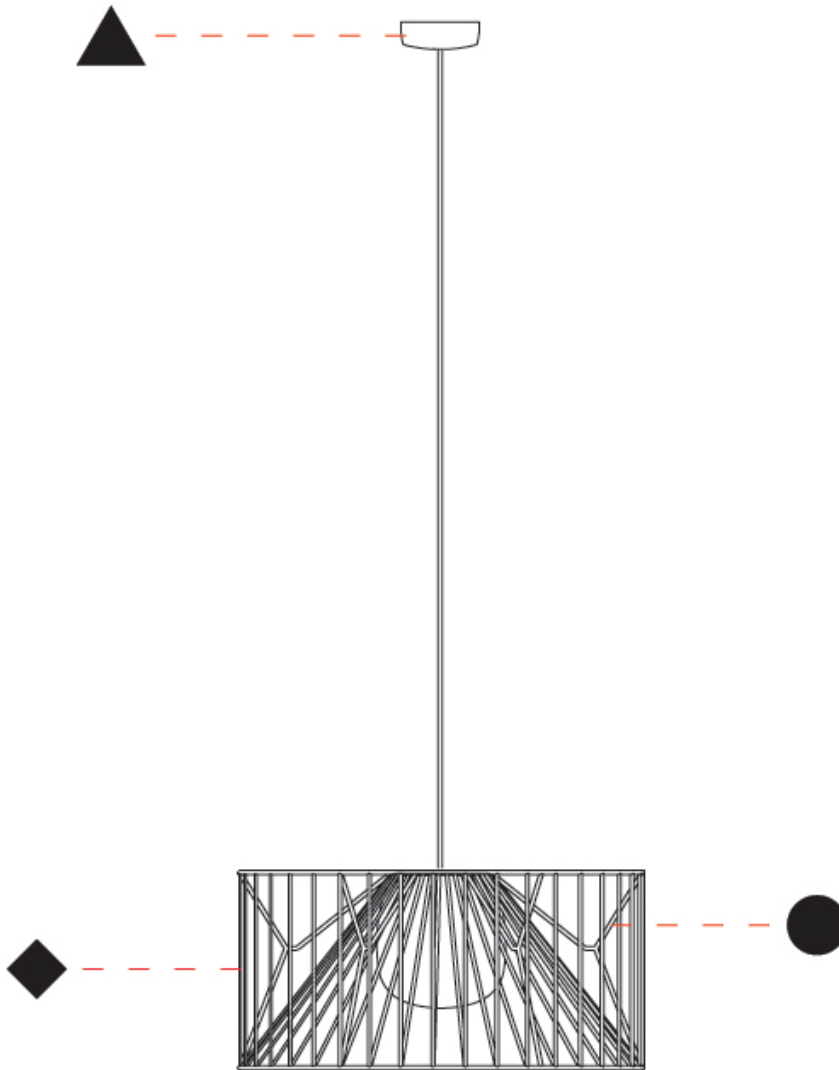

E

## MARIOLA SUSPENSION

**E111199-** \_\_\_\_\_ - \_\_\_\_\_

base number      Finish Options      Finish Options

- To build a product code in our configurator select the specify button on the base model # product page
- To build a manual product code on this datasheet choose from the options listed below in blue font and add the suffix to the base model #

### GENERAL

Series: Mariola  
 Partner: Ole  
 Division: Exterior  
 Installation: Suspension  
 Product Type: Pendant  
 Mounting Location: Ceiling

### PHYSICAL

Shape: Drum  
 Diameter (mm): 800  
 Diameter (in): 31 1/2  
 Height (mm): 160  
 Height (in): 6 5/16  
 Max. Overall Height (mm): 2160  
 Max. Overall Height (in): 85 1/4  
 Fixture Finish: BEI / BLK / BLU / COG / DGN / GRY / MRN / MOC / MUS / OLV / SIL / STN / TER / WHI  
 Holder Finish: MBK  
 Accent Finish: WHI / GSD  
 Fixture Material: Fabric Cord / Metal  
 Primary Material: Fabric - Recycled  
 Cable Details: 2000mm/78 3/4" Transparent Cable  
 Upon Request: Matte White Holder

### ELECTRICAL

Number of Lamps: 1  
 Lamp Type: LED Retrofit  
 Bulb Included: Bulb Not Included  
 Max. Wattage Per Lamp (W): 15  
 Lamp Base: E26  
 Input Voltage (V): 120

### LED

### OPTICAL

### RATINGS AND CERTIFICATIONS

Certified By: Certified for North American Standards  
 IP rating: IP66

PROJECT	_____
TYPE	_____
SPECIFIER	_____
QUANTITY	_____
DATE	_____

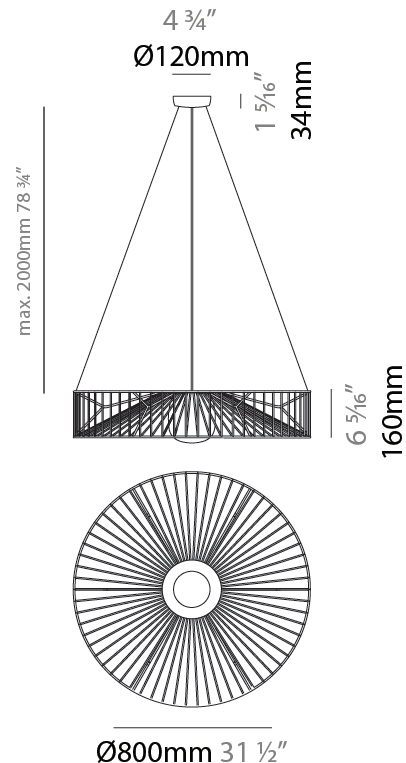

## MARIOLA SUSPENSION

E111199-

PROJECT \_\_\_\_\_

TYPE \_\_\_\_\_

SPECIFIER \_\_\_\_\_

QUANTITY \_\_\_\_\_

DATE \_\_\_\_\_

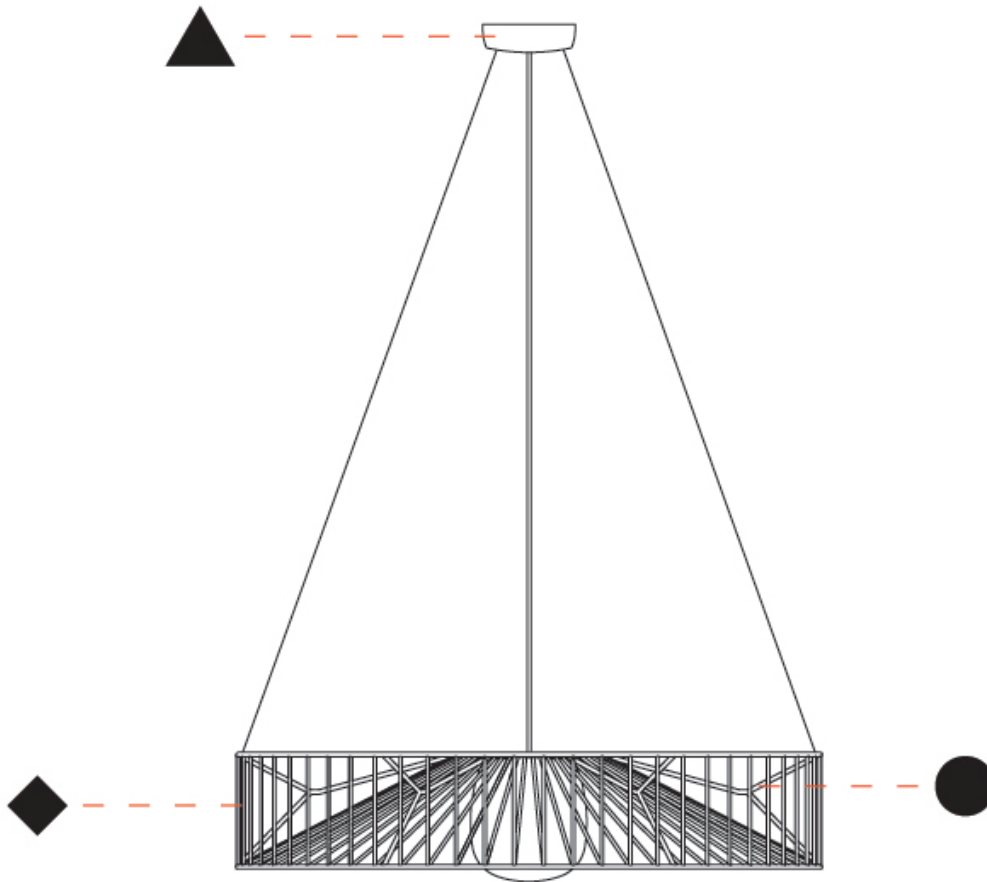

E

## MARIOLA SURFACE

### E112052-

base number      Finish      Finish  
Options            Options

- To build a product code in our configurator select the specify button on the base model # product page
- To build a manual product code on this datasheet choose from the options listed below in blue font and add the suffix to the base model #

#### GENERAL

Series: Mariola  
 Partner: Ole  
 Division: Exterior  
 Installation: Surface  
 Product Type: Ceiling Surface  
 Mounting Location: Ceiling

#### PHYSICAL

Shape: Drum  
 Diameter (mm): 500  
 Diameter (in): 19 <sup>11</sup>/<sub>16</sub>"  
 Height (mm): 490  
 Height (in): 19 <sup>5</sup>/<sub>16</sub>"  
 Fixture Finish: BEI / BLK / BLU / COG / DGN / GRY / MRN / MOC / MUS / OLV / SIL / STN / TER / WHI  
 Holder Finish: WHI / GSD  
 Accent Finish: WHI  
 Fixture Material: Fabric Cord / Metal  
 Primary Material: Fabric - Recycled

#### ELECTRICAL

Number of Lamps: 1  
 Lamp Type: LED Retrofit  
 Bulb Included: Bulb Included  
 Max. Wattage Per Lamp (W): 15  
 Lamp Base: E26  
 Input Voltage (V): 120

#### LED

#### OPTICAL

#### RATINGS AND CERTIFICATIONS

Certified By: Certified for North American Standards  
 IP rating: IP66

PROJECT
TYPE
SPECIFIER
QUANTITY
DATE

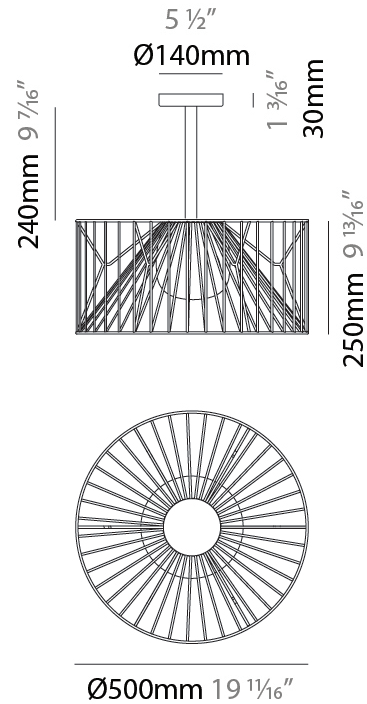

## MARIOLA SURFACE

E112052-

PROJECT

TYPE

SPECIFIER

QUANTITY

DATE

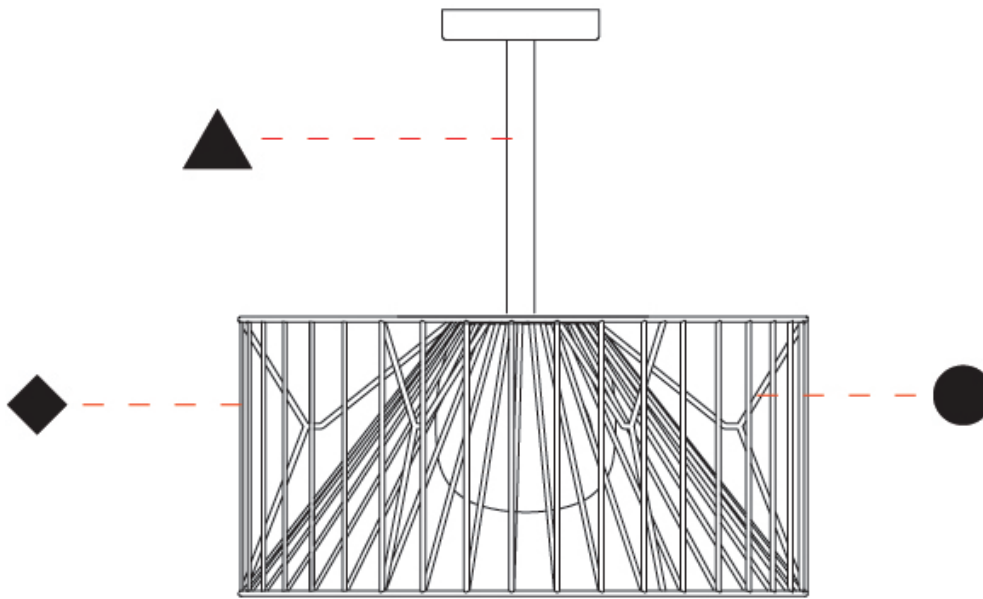

E

## MARIOLA COLOR FINISH CHART

PROJECT \_\_\_\_\_  
TYPE \_\_\_\_\_  
SPECIFIER \_\_\_\_\_  
QUANTITY \_\_\_\_\_  
DATE \_\_\_\_\_

### Fixture Finish

Beige - BEI



Black - BLK



Blue - BLU



Cognac - COG



Dark Green - DGN



Gray - GRY



Maroon - MRN



Mocha - MOC



Mustard - MUS



Olive - OLV



Silver - SIL



Stone - STN



Terracotta - TER



White - WHI



### Holder Finish

Matte Black - MBK

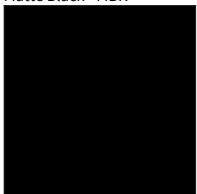

White - WHI

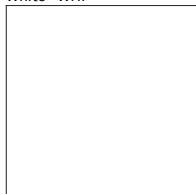

Granulated Sand - GSD

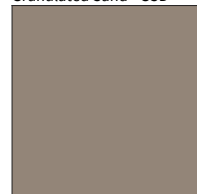

## MARIOLA SURFACE,SUSPENSION COLOR FINISH CHART

PROJECT \_\_\_\_\_

TYPE \_\_\_\_\_

SPECIFIER \_\_\_\_\_

QUANTITY \_\_\_\_\_

DATE \_\_\_\_\_

### Accent Finish

White - WHI

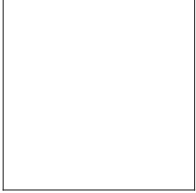

Granulated Sand - GSD



**Digital:** Not all screens are calibrated the same, and therefore, colors will appear differently between screens.

**Physical:** When texture is involved, there will be variations in color, character and tone within a product series and between product families.



## COMPLETE COLOR FINISH CHART

### Standard Colors of Recycles Cords

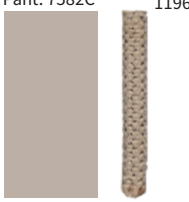
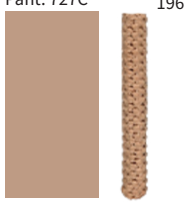
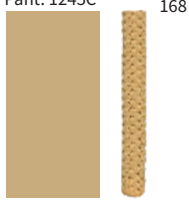
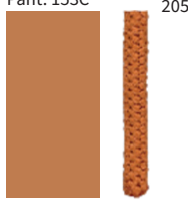
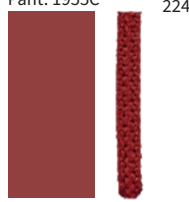
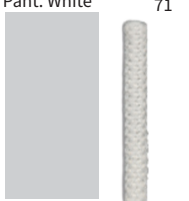
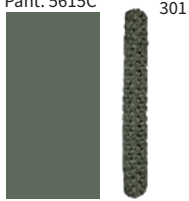
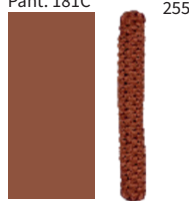
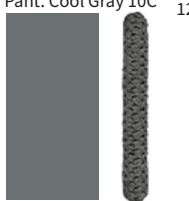
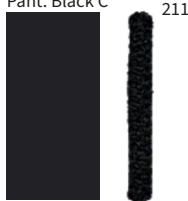
<p>STONE Pant. 7582C</p>  <p>1196</p>	<p>BEIGE Pant. 727C</p>  <p>196</p>	<p>MUSTARD Pant. 1245C</p>  <p>168</p>	<p>TERRACOTTA Pant. 153C</p>  <p>205</p>	<p>MAROON Pant. 1955C</p>  <p>224</p>
<p>WHITE Pant. White</p>  <p>71</p>	<p>OLIVE Pant. 5625C</p>  <p>323</p>	<p>DARK GREEN Pant. 5615C</p>  <p>301</p>	<p>MOCHA Pant. 7504C</p>  <p>175</p>	<p>COGNAC Pant. 181C</p>  <p>255</p>
<p>BLUE Pant. 663C</p>  <p>61</p>	<p>SILVER Pant. Cool Gray 7C</p>  <p>129</p>	<p>GREY Pant. Cool Gray 10C</p>  <p>120</p>	<p>BLACK Pant. Black C</p>  <p>211</p>	

### Sustainable Thin Cord

<p>REDCLAY</p> 	<p>TERRA</p> 	<p>TYPHOON</p> 	<p>BLACK</p> 	<p>FOREST</p> 
--	--	--	---	---

Standard Colors with [S-]

Other fabric cord colors available upon request. Price increase and minimum quantities may apply

**Digital:** Not all screens are calibrated the same, and therefore, colors will appear differently between screens.

**Physical:** When texture is involved, there will be variations in color, character and tone within a product series and between product families.

Zaneen Group Inc. © 2024, T 1800-388-3382, F 416-247-9319, [www.zaneen.com](http://www.zaneen.com)

Available for International specifications by adding 'INT' at the end of the existing Model #. For assistance on 'custom' specifications, contact [zteam@zaneen.com](mailto:zteam@zaneen.com).

In a constant effort to supply the best product, we reserve the right to change specifications or materials without notice. The most recent specification sheets are found at [zaneen.com](http://zaneen.com)

## COMPLETE COLOR FINISH CHART

Special Colors (for indoor use only)

<p>CRISTAL Pant. Glass 75</p> 	<p>Crudo Pant. 7401C 170</p> 	<p>ORO Pant. 872C 16</p> 	<p>GOLDEN Pant. 7403C 7</p> 	<p>AVELLANA Pant. 1955C 152</p> 
<p>ALPACA Pant. 429C 1401</p> 	<p>ARENA Pant. 465C 151</p> 	<p>CASTOR Pant. P7530C 167</p> 	<p>TABACO Pant. 1545C 203</p> 	<p>MARRON Pant. 476C 187</p> 
<p>TUNEL Pant. Black 7C 169</p> 	<p>BURDEOS Pant. 188C 163</p> 	<p>FRESILLA Pant. 695C 273</p> 	<p>ARCILLA Pant. 1675C 205</p> 	<p>SATAN Pant. 207C 19</p> 
<p>MUSGO Pant. 5535C 320</p> 	<p>NOCTURNO Pant. 7547 66</p> 	<p>MEDAS Pant. 295C 168</p> 	<p>LAVA Pant. 151C 1334</p> 	<p>FUEGO Pant. 185C 245</p> 
<p>VERDE OSCURO Pant. 3298C 358</p> 	<p>MARINO Pant. 289C 63</p> 	<p>AZUL ELECTRICO Pant. 2945C 168</p> 	<p>CALABAZA Pant. 158C 84</p> 	<p>ROJO Pant. 186C 241</p> 
<p>JUNGLA Pant. 356C 310</p> 	<p>AZUL ROYAL Pant. 288C 1075</p> 	<p>VIOLETA Pant. 7676U 147</p> 	<p>AMARILLO Pant. 109U 1</p> 	<p>CICLAMOR Pant. 205C 264</p> 

Standard Colors with [S-]

Other fabric cord colors available upon request. Price increase and minimum quantities may apply

**Digital:** Not all screens are calibrated the same, and therefore, colors will appear differently between screens.

**Physical:** When texture is involved, there will be variations in color, character and tone within a product series and between product families.

Zaneen Group Inc. © 2024, T 1800-388-3382, F 416-247-9319, [www.zaneen.com](http://www.zaneen.com)

Available for International specifications by adding 'INT' at the end of the existing Model #. For assistance on 'custom' specifications, contact [zteam@zaneen.com](mailto:zteam@zaneen.com).

In a constant effort to supply the best product, we reserve the right to change specifications or materials without notice. The most recent specification sheets are found at [zaneen.com](http://zaneen.com)

### LEGEND

	floor-mounted		pivotal		special LED (upon request) RGB, RGBW, tunable, gold+, meat+, art+, fashion+
	wall and ceiling: recessed and surface mounted		rotating		warm dim / natural dimming LED
	ceiling-mounted and wall-mounted		illuminate tilted		rechargeable battery powered
	wall-mounted		color of suspension cable		fixture with natural vivid LED (upon request)
	omni-directional light distribution		length of suspension cable		color rendering index
	direct light distribution		reflector degree selection		color temperature
	direct/indirect light distribution		super spot		lumen (luminous flux)
	indirect light distribution		lens		efficacy (lumens per watt)
	asymmetric light distribution		lens pack		Unified Glare Rating (UGR) range from 5-40
	aura light distribution		shine ring		marine grade (AISI 316 stainless steel)
	round wall or ceiling cut-out		integrated shine ring with diffuser		walk on
	square wall or ceiling cut-out		free individual colors 01-29		drive on
	the supplied jig specifies the cutout dimensions		individual colors: 00 (free of charge), 01-25 (extra charge)		Dark Sky Compliance
	minimum distance (meters) lamp - object		luminaire part to be colored (F1)		Americans with Disabilities Act (less than 4" off the wall located between 27"-84" from floor)
	recessed depth		luminaire part to be colored (F2)		lamp protected against explosion
	ceiling thickness in mm		luminaire part to be colored (F3)		blown glass using traditional methods by master glass blower
	ceiling thickness selection		luminaire part to be colored (F4)		acoustic material
	dimnable DP (phase), DV (0-10V), DD (dali), DS (step-dim)		luminaire part to be colored (F5)		protection class I, protection insulation
	included or excluded LED driver/transformer/control gear		color of 3-circuit adaptor		protection class II, protection insulation
	separately switchable		indirect diffuser		ETL Certified to UL and CSA Standards
	sensor		direct diffuser		UL Certified to UL and CSA Standards
	remote control		ball-proof (upon request)		CSA Certified to UL and CSA Standards
	available upon request		accessory		Certified for North American Standards

### IP RATING

	protected against ingress of solid bodies greater than 12.5mm (finger)
	protected against ingress of solid bodies greater than 2.5mm protected against sprays of water up to 60 degrees from the vertical (rain)
	protected against ingress of solid bodies greater than 1mm (wire) no protection against the ingress of moisture
	protected against ingress of solid bodies greater than 1mm (wire) protected against sprays of water up to 60 degrees from the vertical (rain)
	protected against ingress of solid bodies greater than 1mm (wire) protected against water splashed from all directions
	protected against limited ingress of dust (wet rooms/covered outdoor areas) protected against water splashed from all directions
	protected against ingress of dust protected against jets of water
	protected against ingress of dust protected against powerful jets of water or heavy seas
	protected against ingress of dust protected against immersion of water between 15cm - 1m for 30 minutes
	protected against ingress of dust protected against immersion of water under pressure for long periods

### IK RATING

	protected against 0.14 joules impact (equivalent to 0.25kg mass dropped from 56mm above the surface)
	protected against 0.2 joules impact (equivalent to 0.25kg mass dropped from 80mm above the surface)
	protected against 0.35 joules impact (equivalent to 0.25kg mass dropped from 140mm above the surface)
	protected against 0.5 joules impact (equivalent to 0.25kg mass dropped from 200mm above the surface)
	protected against 0.7 joules impact (equivalent to 0.25kg mass dropped from 280mm above the surface)
	protected against 1 joules impact (equivalent to 0.25kg mass dropped from 400mm above the surface)
	protected against 2 joules impact (equivalent to 0.5kg mass dropped from 400mm above the surface)
	protected against 5 joules impact (equivalent to 1.7kg mass dropped from 300mm above the surface)
	protected against 10 joules impact (equivalent to 5.0kg mass dropped from 200mm above the surface)
	protected against 20 joules impact (equivalent to 5.0kg mass dropped from 400mm above the surface)