

MARK - MONOPOINT SUSPENSION

D141312-

base number Color Finish Finish
 Temperature Options Options

- To build a product code in our configurator select the specify button on the base model # product page
- To build a manual product code on this datasheet choose from the options listed below in blue font and add the suffix to the base model #

GENERAL

Series: Mark
 Subseries: Mark - Monopoint
 Partner: Cangini & Tucci
 Division: Design
 Installation: Suspension
 Product Type: Pendant
 Mounting Location: Ceiling

PHYSICAL

Shape: Oval
 Diameter (mm): 250
 Diameter (in): 9 ¹³/₁₆
 Height (mm): 220
 Height (in): 8 ¹¹/₁₆
 Max. Overall Height (mm): 2220
 Max. Overall Height (in): 86 ⁵/₈
 Weight (kg): 1.20
 Weight (lbs): 2.65
 Fixture Finish: [AMB / BLK / BRZ / GLD / GRN / PNK / RGD / RUB / SKB / SMK / STE / TOB / TRA](#)
 Holder Finish: CHR / BCR / MWH / MBK
 Fixture Material: Glass / Metal
 Primary Material: Glass - Borosilicate
 Cable Details: 2000mm/78 3/4" Transparent Cable

ELECTRICAL

Lamp Type: LED
 Input Wattage (W): 6
 Dimming: Tri-Mode (Non-Dimming and Phase Dimming (120Vac only) and 0-10V Dimming)
 Driver Included: Yes
 Driver Location: Integrated
 Driver Type: Constant Current - Universal
 Driver Class: Class 2
 Input Voltage (V): 120
 Constant Current (MA): 500mA

LED

Number of LEDs: 1
 Color Temperature (°K): [2700 / 3000](#)
 Nominal Lumen (lm): 866
 CRI: >95 CRI
 Efficacy (lm/w): 144
 Lamp Life (hrs): 50000

OPTICAL

RATINGS AND CERTIFICATIONS

Certified By: Certified for North American Standards
 IP rating: IP20

| |
|-----------|
| PROJECT |
| TYPE |
| SPECIFIER |
| QUANTITY |
| DATE |



MARK - MONOPOINT SUSPENSION

D141312-

PROJECT _____

TYPE _____

SPECIFIER _____

QUANTITY _____

DATE _____

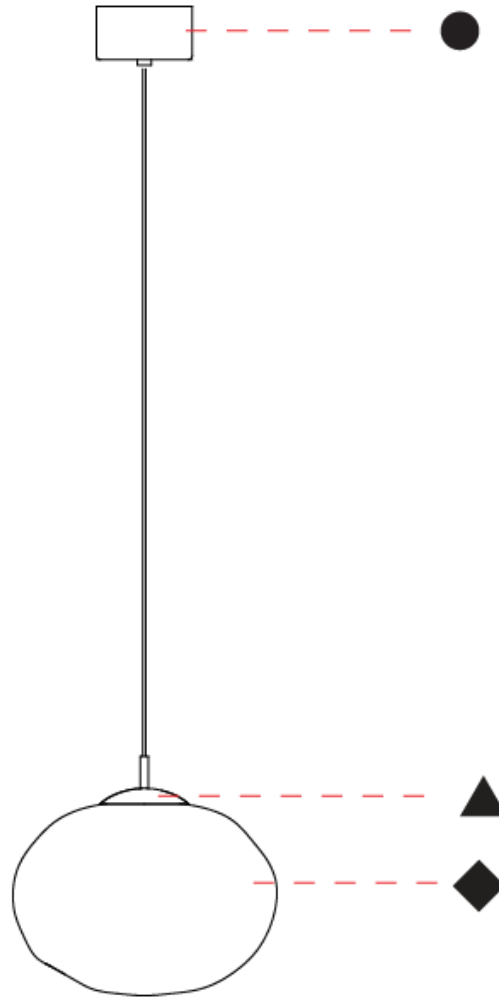

D

MARK - MONOPOINT SUSPENSION

D141313-

base number Color Finish Finish
 Temperature Options Options

- To build a product code in our configurator select the specify button on the base model # product page
- To build a manual product code on this datasheet choose from the options listed below in blue font and add the suffix to the base model #

GENERAL

Series: Mark
 Subseries: Mark - Monopoint
 Partner: Cangini & Tucci
 Division: Design
 Installation: Suspension
 Product Type: Pendant
 Mounting Location: Ceiling

PHYSICAL

Shape: Round
 Diameter (mm): 300
 Diameter (in): 11 ¹³/₁₆
 Height (mm): 300
 Height (in): 12 ³/₁₆
 Max. Overall Height (mm): 2300
 Max. Overall Height (in): 90 ⁹/₁₆
 Weight (kg): 1.50
 Weight (lbs): 3.31
 Diffuser: Glass
 Fixture Finish: [AMB / BLK / BRZ / GLD / GRN / PNK / RGD / RUB / SKB / SMK / STE / TOB / TRA](#)
 Holder Finish: CHR / BCR / MWH / MBK
 Fixture Material: Glass / Metal
 Primary Material: Glass - Borosilicate
 Cable Details: 2000mm/78 3/4" Transparent Cable

ELECTRICAL

Lamp Type: LED
 Input Wattage (W): 8.4
 Dimming: Tri-Mode (Non-Dimming and Phase Dimming (120Vac only) and 0-10V Dimming)
 Driver Included: Yes
 Driver Location: Integrated
 Driver Type: Constant Current - Universal
 Driver Class: Class 2
 Input Voltage (V): 120
 Constant Current (MA): 350mA

LED

Number of LEDs: 1
 Color Temperature (°K): [2700 / 3000](#)
 Nominal Lumen (lm): 1202
 CRI: >95 CRI
 Efficacy (lm/w): 144
 Lamp Life (hrs): 50000

OPTICAL

RATINGS AND CERTIFICATIONS

Certified By: Certified for North American Standards
 IP rating: IP20

| |
|-----------|
| PROJECT |
| TYPE |
| SPECIFIER |
| QUANTITY |
| DATE |

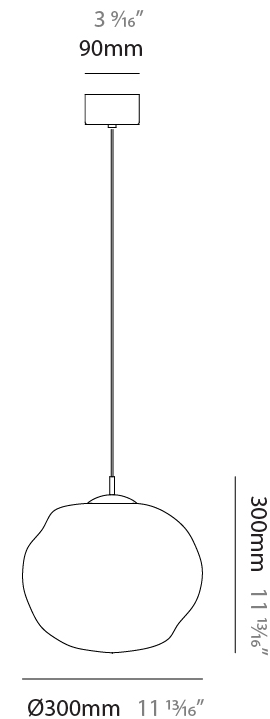

MARK - MONOPOINT SUSPENSION

D141313-

| | |
|-----------|-------|
| PROJECT | _____ |
| TYPE | _____ |
| SPECIFIER | _____ |
| QUANTITY | _____ |
| DATE | _____ |

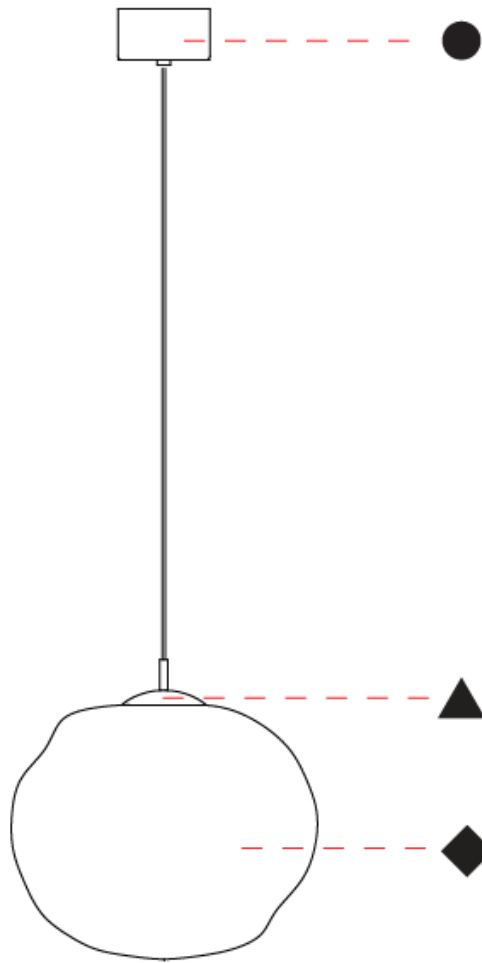

D

MARK - MONOPOINT SUSPENSION

D141314-

base number Color Finish Finish
 Temperature Options Options

- To build a product code in our configurator select the specify button on the base model # product page
- To build a manual product code on this datasheet choose from the options listed below in blue font and add the suffix to the base model #

GENERAL

Series: Mark
 Subseries: Mark - Monopoint
 Partner: Cangini & Tucci
 Division: Design
 Installation: Suspension
 Product Type: Pendant
 Mounting Location: Ceiling

PHYSICAL

Shape: Oval
 Diameter (mm): 250
 Diameter (in): 9 ¹³/₁₆
 Height (mm): 190
 Height (in): 7 ¹/₂
 Max. Overall Height (mm): 2190
 Max. Overall Height (in): 8 ³/₄
 Weight (kg): 1.20
 Weight (lbs): 2.65
 Diffuser: Glass
 Fixture Finish: [AMB / BLK / BRZ / GLD / GRN / PNK / RGD / RUB / SKB / SMK / STE / TOB / TRA](#)
 Holder Finish: CHR / BCR / MWH / MBK
 Fixture Material: Glass / Metal
 Primary Material: Glass - Borosilicate
 Cable Details: 2000mm/78 3/4" Transparent Cable

ELECTRICAL

Lamp Type: LED
 Input Wattage (W): 6
 Dimming: Tri-Mode (Non-Dimming and Phase Dimming (120Vac only) and 0-10V Dimming)
 Driver Included: Yes
 Driver Location: Integrated
 Driver Type: Constant Current - Universal
 Driver Class: Class 2
 Input Voltage (V): 120
 Constant Current (MA): 500mA

LED

Number of LEDs: 1
 Color Temperature (°K): [2700 / 3000](#)
 Nominal Lumen (lm): 866
 CRI: >95 CRI
 Efficacy (lm/w): 144
 Lamp Life (hrs): 50000

OPTICAL

RATINGS AND CERTIFICATIONS

Certified By: Certified for North American Standards
 IP rating: IP20

| |
|-----------|
| PROJECT |
| TYPE |
| SPECIFIER |
| QUANTITY |
| DATE |

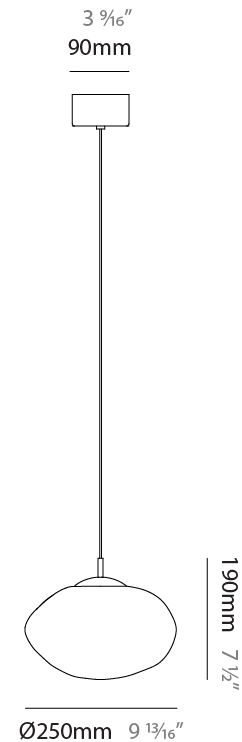

MARK - MONOPOINT SUSPENSION

D141314-

PROJECT _____

TYPE _____

SPECIFIER _____

QUANTITY _____

DATE _____

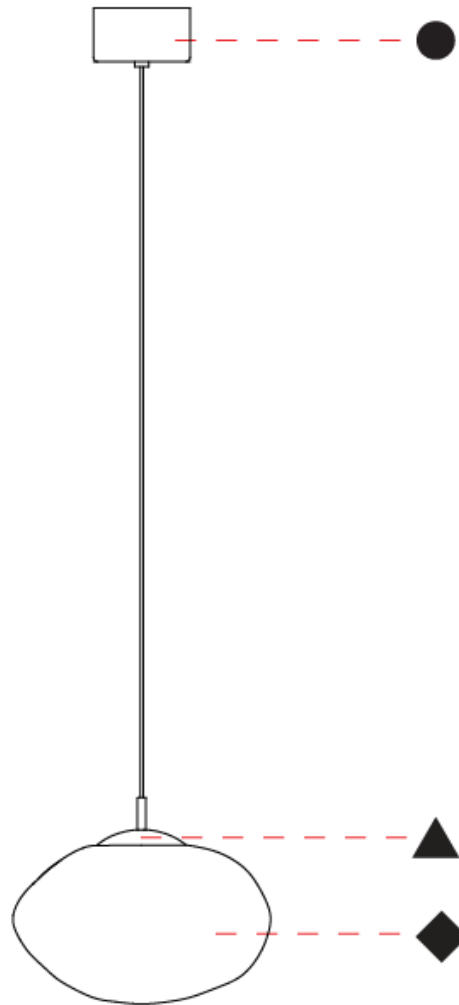

D

MARK - MONOPOINT SUSPENSION

D141315-

base number Color Finish Finish
 Temperature Options Options

- To build a product code in our configurator select the specify button on the base model # product page
- To build a manual product code on this datasheet choose from the options listed below in blue font and add the suffix to the base model #

GENERAL

Series: Mark
 Subseries: Mark - Monopoint
 Partner: Cangini & Tucci
 Division: Design
 Installation: Suspension
 Product Type: Pendant
 Mounting Location: Ceiling

PHYSICAL

Shape: Oval
 Diameter (mm): 300
 Diameter (in): 11 ¹³/₁₆
 Height (mm): 240
 Height (in): 9 ⁷/₁₆
 Max. Overall Height (mm): 2240
 Max. Overall Height (in): 88 ³/₁₆
 Weight (kg): 1.50
 Weight (lbs): 3.31
 Diffuser: Glass
 Fixture Finish: [AMB](#) / [BLK](#) / [BRZ](#) / [GLD](#) / [GRN](#) / [PNK](#) / [RGD](#) / [RUB](#) / [SKB](#) / [SMK](#) / [STE](#) / [TOB](#) / [TRA](#)
 Holder Finish: [CHR](#) / [BCR](#) / [MWH](#) / [MBK](#)
 Fixture Material: Glass / Metal
 Primary Material: Glass - Borosilicate
 Cable Details: 2000mm/78 3/4" Transparent Cable

ELECTRICAL

Lamp Type: LED
 Input Wattage (W): 8.4
 Dimming: Tri-Mode (Non-Dimming and Phase Dimming (120Vac only) and 0-10V Dimming)
 Driver Included: Yes
 Driver Location: Integrated
 Driver Type: Constant Current - Universal
 Driver Class: Class 2
 Input Voltage (V): 120
 Constant Current (MA): 350mA

LED

Number of LEDs: 1
 Color Temperature (°K): [2700](#) / [3000](#)
 Nominal Lumen (lm): 1202
 CRI: >95 CRI
 Efficacy (lm/w): 144
 Lamp Life (hrs): 50000

OPTICAL

RATINGS AND CERTIFICATIONS

Certified By: Certified for North American Standards
 IP rating: IP20

| |
|-----------|
| PROJECT |
| TYPE |
| SPECIFIER |
| QUANTITY |
| DATE |

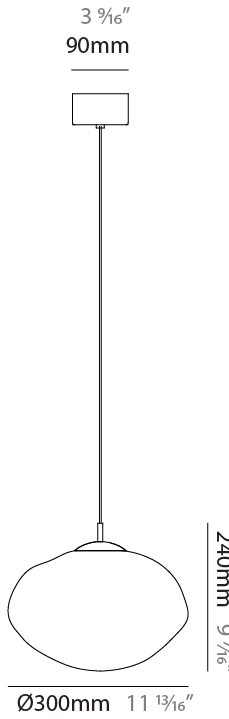

MARK - MONOPOINT SUSPENSION

D141315-

PROJECT _____

TYPE _____

SPECIFIER _____

QUANTITY _____

DATE _____

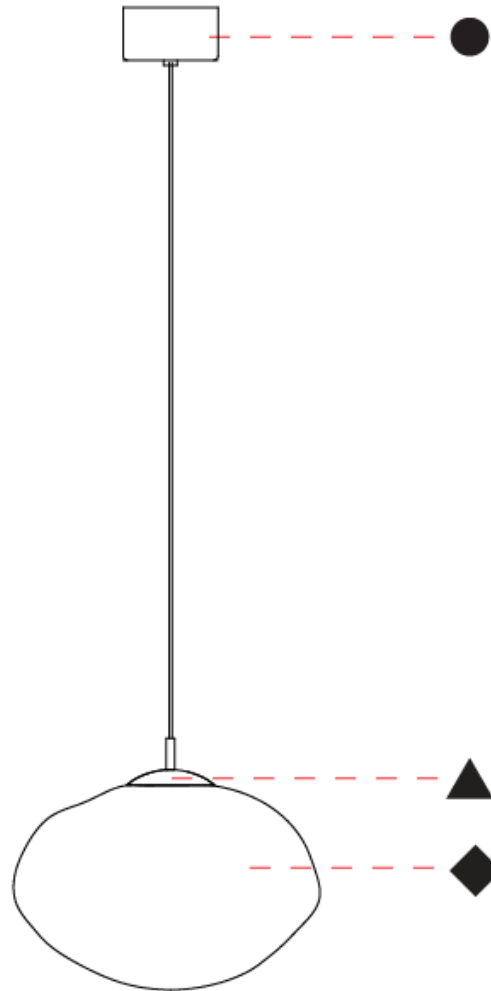

D

MARK - MONOPOINT SUSPENSION

D141316-

base number Color Finish Finish
 Temperature Options Options

- To build a product code in our configurator select the specify button on the base model # product page
- To build a manual product code on this datasheet choose from the options listed below in blue font and add the suffix to the base model #

GENERAL

Series: Mark
 Subseries: Mark - Monopoint
 Partner: Cangini & Tucci
 Division: Design
 Installation: Suspension
 Product Type: Pendant
 Mounting Location: Ceiling

PHYSICAL

Shape: Oval
 Diameter (mm): 300
 Diameter (in): 11 ¹³/₁₆
 Height (mm): 180
 Height (in): 7 ¹/₁₆
 Max. Overall Height (mm): 2180
 Max. Overall Height (in): 85 ¹³/₁₆
 Weight (kg): 1.20
 Weight (lbs): 2.65
 Fixture Finish: [AMB](#) / [BLK](#) / [BRZ](#) / [GLD](#) / [GRN](#) / [PNK](#) / [RGD](#) / [RUB](#) / [SKB](#) / [SMK](#) / [STE](#) / [TOB](#) / [TRA](#)
 Holder Finish: [CHR](#) / [BCR](#) / [MWH](#) / [MBK](#)
 Fixture Material: Glass / Metal
 Primary Material: Glass - Borosilicate
 Cable Details: 2000mm/78 3/4" Transparent Cable

ELECTRICAL

Lamp Type: LED
 Input Wattage (W): 6
 Dimming: Tri-Mode (Non-Dimming and Phase Dimming (120Vac only) and 0-10V Dimming)
 Driver Included: Yes
 Driver Location: Integrated
 Driver Type: Constant Current - Universal
 Driver Class: Class 2
 Input Voltage (V): 120
 Constant Current (MA): 500mA

LED

Number of LEDs: 1
 Color Temperature (°K): [2700](#) / [3000](#)
 Nominal Lumen (lm): 866
 CRI: >95 CRI
 Efficacy (lm/w): 144
 Lamp Life (hrs): 50000

OPTICAL

RATINGS AND CERTIFICATIONS

Certified By: Certified for North American Standards
 IP rating: IP20

| |
|-----------|
| PROJECT |
| TYPE |
| SPECIFIER |
| QUANTITY |
| DATE |

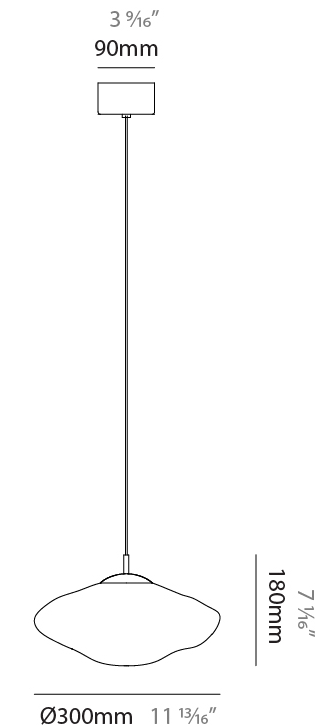

MARK - MONOPOINT SUSPENSION

D141316-

PROJECT _____

TYPE _____

SPECIFIER _____

QUANTITY _____

DATE _____

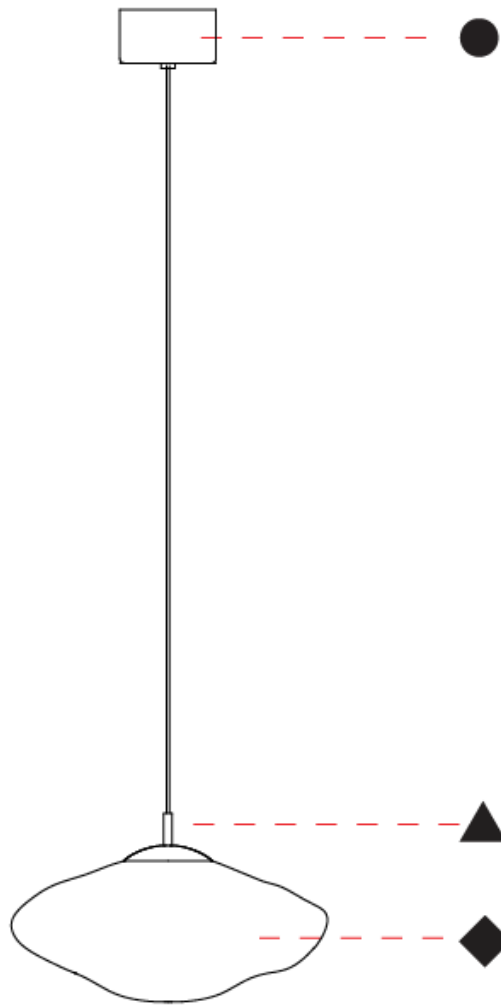

D

MARK - MONOPOINT SUSPENSION

D141317-

base number Color Finish Finish
 Temperature Options Options

- To build a product code in our configurator select the specify button on the base model # product page
- To build a manual product code on this datasheet choose from the options listed below in blue font and add the suffix to the base model #

GENERAL

Series: Mark
 Subseries: Mark - Monopoint
 Partner: Cangini & Tucci
 Division: Design
 Installation: Suspension
 Product Type: Pendant
 Mounting Location: Ceiling

PHYSICAL

Shape: Oval
 Diameter (mm): 350
 Diameter (in): 13 ³/₄
 Height (mm): 200
 Height (in): 8 ¹¹/₁₆
 Max. Overall Height (mm): 2200
 Max. Overall Height (in): 86 ⁵/₈
 Weight (kg): 1.50
 Weight (lbs): 3.31
 Diffuser: Glass
 Fixture Finish: [AMB / BLK / BRZ / GLD / GRN / PNK / RGD / RUB / SKB / SMK / STE / TOB / TRA](#)
 Holder Finish: [CHR / BCR / MWH / MBK](#)
 Fixture Material: Glass / Metal
 Primary Material: Glass - Borosilicate

ELECTRICAL

Lamp Type: LED
 Input Wattage (W): 8.4
 Dimming: Tri-Mode (Non-Dimming and Phase Dimming (120Vac only) and 0-10V Dimming)
 Driver Included: Yes
 Driver Location: Integrated
 Driver Type: Constant Current - Universal
 Driver Class: Class 2
 Input Voltage (V): 120
 Constant Current (MA): 350mA

LED

Number of LEDs: 1
 Color Temperature (°K): [2700 / 3000](#)
 Nominal Lumen (lm): 1202
 CRI: >95 CRI
 Efficacy (lm/w): 144
 Lamp Life (hrs): 50000

OPTICAL

RATINGS AND CERTIFICATIONS

Certified By: Certified for North American Standards
 IP rating: IP20

| |
|-----------|
| PROJECT |
| TYPE |
| SPECIFIER |
| QUANTITY |
| DATE |

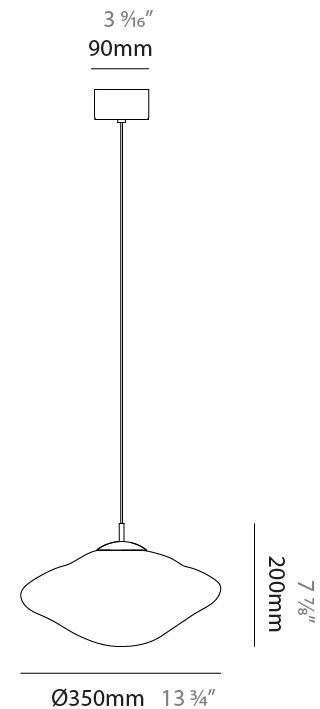

MARK - MONOPOINT SUSPENSION

D141317-

| |
|-----------|
| PROJECT |
| TYPE |
| SPECIFIER |
| QUANTITY |
| DATE |

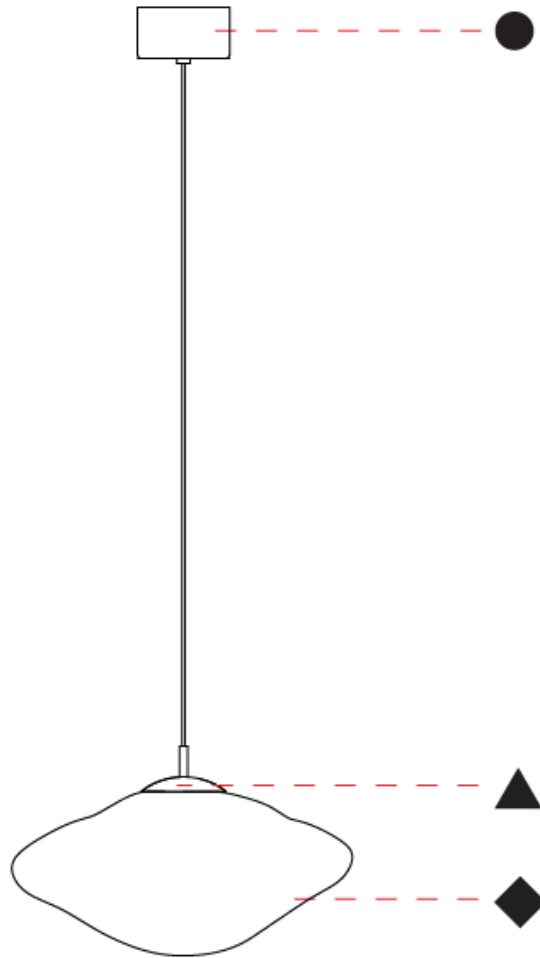

D

| |
|-----------|
| PROJECT |
| TYPE |
| SPECIFIER |
| QUANTITY |
| DATE |

MARK - MONOPOINT SUSPENSION

D141317- : D141317-30K-MBK-TRA

base number Color Temperature Finish Options Finish Options

- To build a product code in our configurator select the specify button on the base model # product page
- To build a manual product code on this datasheet choose from the options listed below in blue font and add the suffix to the base model #

GENERAL

Series: Mark
 Subseries: Mark - Monopoint
 Partner: Cangini & Tucci
 Division: Design
 Installation: Suspension
 Product Type: Pendant
 Mounting Location: Ceiling

PHYSICAL

Shape: Oval
 Diameter (mm): 350
 Diameter (in): 13 ³/₄
 Height (mm): 200
 Height (in): 8 ¹¹/₁₆
 Max. Overall Height (mm): 2200
 Max. Overall Height (in): 86 ⁵/₈
 Weight (kg): 1.50
 Weight (lbs): 3.31
 Diffuser: Glass
 Fixture Finish: [AMB / BLK / BRZ / GLD / GRN / PNK / RGD / RUB / SKB / SMK / STE / TOB / TRA](#)
 Holder Finish: [CHR / BCR / MWH / MBK](#)
 Fixture Material: Glass / Metal
 Primary Material: Glass - Borosilicate

ELECTRICAL

Lamp Type: LED
 Input Wattage (W): 8.4
 Dimming: Tri-Mode (Non-Dimming and Phase Dimming (120Vac only) and 0-10V Dimming)
 Driver Included: Yes
 Driver Location: Integrated
 Driver Type: Constant Current - Universal
 Driver Class: Class 2
 Input Voltage (V): 120
 Constant Current (MA): 350mA

LED

Number of LEDs: 1
 Color Temperature (°K): [2700 / 3000](#)
 Nominal Lumen (lm): 1202
 CRI: >95 CRI
 Efficacy (lm/w): 144
 Lamp Life (hrs): 50000

OPTICAL

RATINGS AND CERTIFICATIONS

Certified By: Certified for North American Standards
 IP rating: IP20

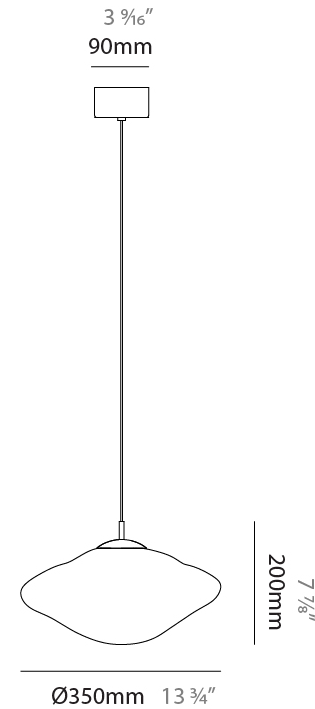

MARK - MONOPOINT SUSPENSION

D141317- : D141317-30K-MBK-TRA

| |
|-----------|
| PROJECT |
| TYPE |
| SPECIFIER |
| QUANTITY |
| DATE |

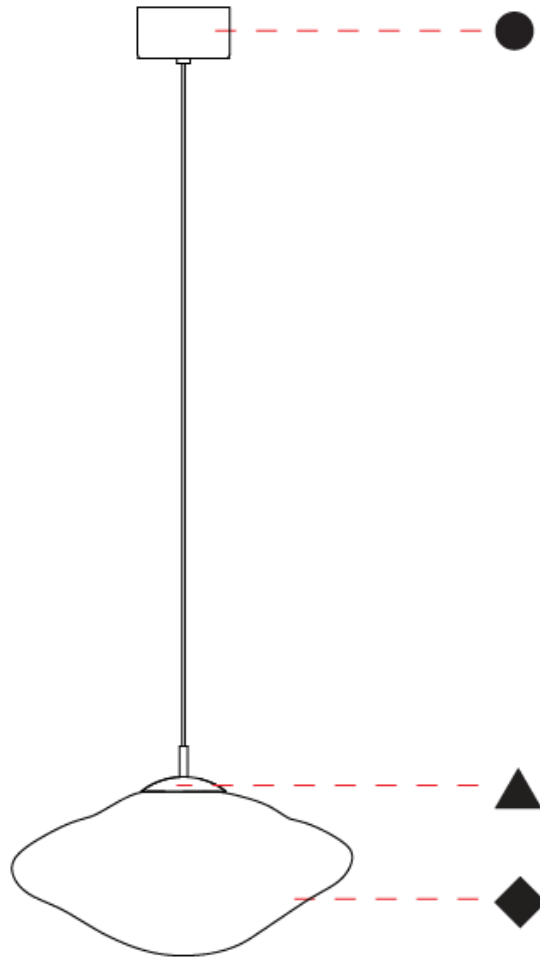

D

MARK - 3L LINEAR SUSPENSION

D141324-

base number Color Finish Finish
 Temperature Options Options

- To build a product code in our configurator select the specify button on the base model # product page
- To build a manual product code on this datasheet choose from the options listed below in blue font and add the suffix to the base model #

GENERAL

Series: Mark
 Subseries: Mark - 3L Linear
 Partner: Cangini & Tucci
 Division: Design
 Installation: Suspension
 Product Type: Clusters
 Mounting Location: Ceiling

PHYSICAL

Diameter (mm): 300
 Diameter (in): 11 ¹³/₁₆
 Length (mm): 1200
 Length (in): 47 ¹/₄
 Height (mm): 300
 Height (in): 11 ¹³/₁₆
 Max. Overall Height (mm): 2300
 Max. Overall Height (in): 90 ⁹/₁₆
 Weight (kg): 1.50
 Weight (lbs): 3.31
 Diffuser: Glass
 Fixture Finish: [AMB / BLK / BRZ / GLD / GRN / PNK / RGD / RUB / SKB / SMK / STE / TOB / TRA](#)
 Holder Finish: [CHR / BCR / MWH / MBK](#)
 Fixture Material: Glass / Metal
 Primary Material: Glass - Borosilicate

ELECTRICAL

Lamp Type: LED
 Input Wattage (W): 25.2
 Dimming: Tri-Mode (Non-Dimming and Phase Dimming (120Vac only) and 0-10V Dimming)
 Driver Included: Yes
 Driver Location: Integrated
 Driver Type: Constant Current - Universal
 Driver Class: Class 2
 Input Voltage (V): 120
 Constant Current (MA): 350mA

LED

Number of LEDs: 3
 Color Temperature (°K): [2700 / 3000](#)
 Nominal Lumen (lm): 3606
 CRI: >95 CRI
 Lamp Life (hrs): 50000

OPTICAL

RATINGS AND CERTIFICATIONS

Certified By: Certified for North American Standards
 IP rating: IP20

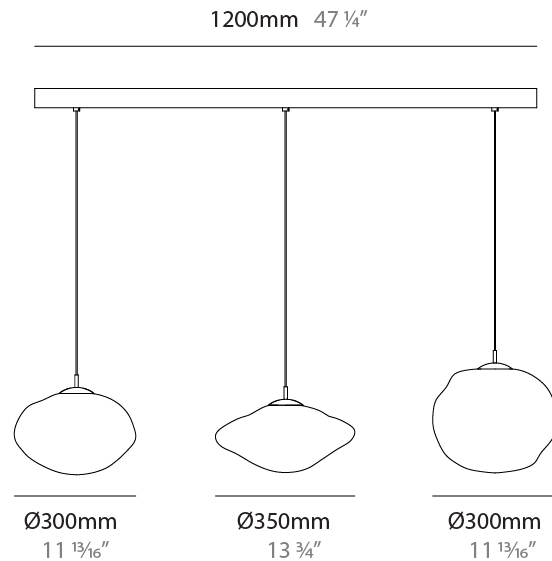

MARK - 3L LINEAR SUSPENSION

D141324-

| | |
|-----------|-------|
| PROJECT | _____ |
| TYPE | _____ |
| SPECIFIER | _____ |
| QUANTITY | _____ |
| DATE | _____ |

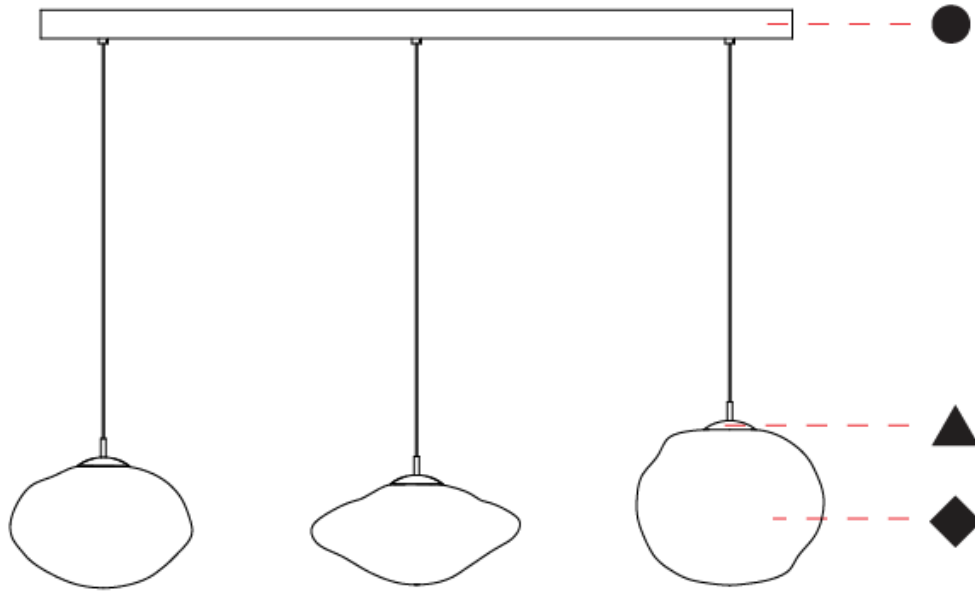

D

| | |
|-----------|-------|
| PROJECT | _____ |
| TYPE | _____ |
| SPECIFIER | _____ |
| QUANTITY | _____ |
| DATE | _____ |

MARK - 3L CLUSTER SUSPENSION

D141325-

| | | | |
|-------------|-------------|---------|---------|
| base number | Color | Finish | Finish |
| | Temperature | Options | Options |

- To build a product code in our configurator select the specify button on the base model # product page
- To build a manual product code on this datasheet choose from the options listed below in blue font and add the suffix to the base model #

GENERAL

| |
|------------------------------|
| Series: Mark |
| Subseries: Mark - 3L Cluster |
| Partner: Cangini & Tucci |
| Division: Design |
| Installation: Suspension |
| Product Type: Clusters |
| Mounting Location: Ceiling |

PHYSICAL

| |
|---|
| Diameter (mm): 430 |
| Diameter (in): 16 ¹⁵ / ₁₆ |
| Height (mm): 300 |
| Height (in): 11 ¹³ / ₁₆ |
| Max. Overall Height (mm): 2300 |
| Max. Overall Height (in): 90 ⁹ / ₁₆ |
| Weight (kg): 5.30 |
| Weight (lbs): 11.68 |
| Diffuser: Glass |
| Fixture Finish: AMB / BLK / BRZ / GLD / GRN / PNK / RGD / RUB / SKB / SMK / STE / TOB / TRA |
| Holder Finish: CHR / BCR / MWH / MBK |
| Fixture Material: Glass / Metal |
| Primary Material: Glass - Borosilicate |

ELECTRICAL

| |
|---|
| Lamp Type: LED |
| Input Wattage (W): 18 |
| Dimming: Tri-Mode (Non-Dimming and Phase Dimming (120Vac only) and 0-10V Dimming) |
| Driver Included: Yes |
| Driver Location: Integrated |
| Driver Type: Constant Current - Universal |
| Driver Class: Class 2 |
| Input Voltage (V): 120 |
| Constant Current (MA): 500mA |

LED

| |
|---|
| Number of LEDs: 3 |
| Color Temperature (°K): 2700 / 3000 |
| Nominal Lumen (lm): 2598 |
| CRI: >95 CRI |
| Lamp Life (hrs): 50000 |

OPTICAL

RATINGS AND CERTIFICATIONS

| |
|--|
| Certified By: Certified for North American Standards |
| IP rating: IP20 |

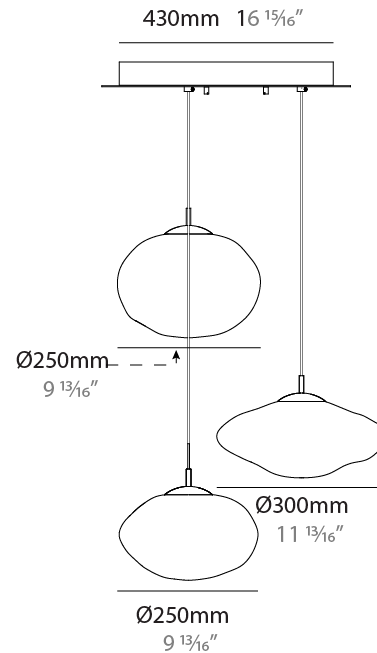

MARK - 3L CLUSTER SUSPENSION

D141325-

| | |
|-----------|-------|
| PROJECT | _____ |
| TYPE | _____ |
| SPECIFIER | _____ |
| QUANTITY | _____ |
| DATE | _____ |

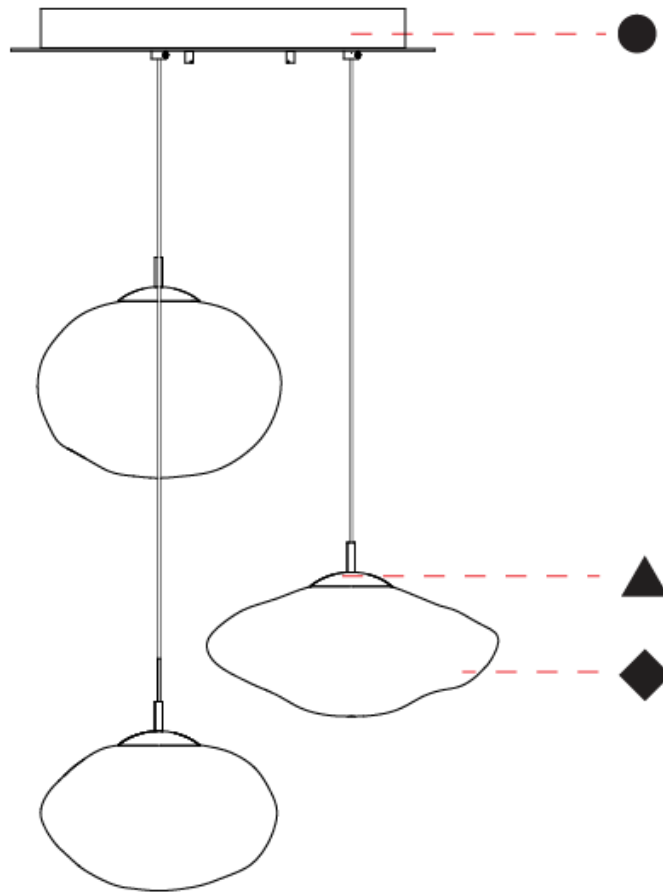

D

MARK - 7L CLUSTER SUSPENSION

D141326-

base number Color Finish Finish
 Temperature Options Options

- To build a product code in our configurator select the specify button on the base model # product page
- To build a manual product code on this datasheet choose from the options listed below in blue font and add the suffix to the base model #

GENERAL

Series: Mark
 Subseries: Mark - 7L Cluster
 Partner: Cangini & Tucci
 Division: Design
 Installation: Suspension
 Product Type: Clusters
 Mounting Location: Ceiling

PHYSICAL

Length (mm): 1300
 Length (in): 51 ³/₁₆
 Width (mm): 400
 Width (in): 15 ³/₄
 Height (mm): 300
 Height (in): 11 ¹³/₁₆
 Max. Overall Height (mm): 2300
 Max. Overall Height (in): 90 ⁹/₁₆
 Weight (kg): 20.30
 Weight (lbs): 44.75
 Diffuser: Glass
 Fixture Finish: [AMB / BLK / BRZ / GLD / GRN / PNK / RGD / RUB / SKB / SMK / STE / TOB / TRA](#)
 Holder Finish: [CHR / BCR / MWH / MBK](#)
 Fixture Material: Glass / Metal
 Primary Material: Glass - Borosilicate

ELECTRICAL

Lamp Type: LED
 Input Wattage (W): 58.8
 Dimming: Tri-Mode (Non-Dimming and Phase Dimming (120Vac only) and 0-10V Dimming)
 Driver Included: Yes
 Driver Location: Integrated
 Driver Type: Constant Current - Universal
 Driver Class: Class 2
 Input Voltage (V): 120
 Constant Current (MA): 350mA

LED

Number of LEDs: 7
 Color Temperature (°K): [2700 / 3000](#)
 Nominal Lumen (lm): 8414
 CRI: >95 CRI
 Lamp Life (hrs): 50000

OPTICAL

RATINGS AND CERTIFICATIONS

Certified By: Certified for North American Standards
 IP rating: IP20

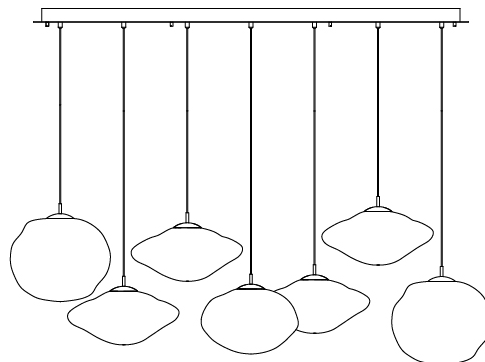
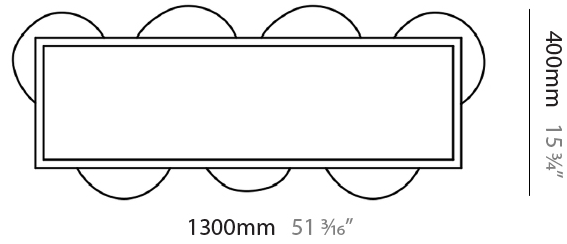

MARK - 7L CLUSTER SUSPENSION

D141326-

| | |
|-----------|-------|
| PROJECT | _____ |
| TYPE | _____ |
| SPECIFIER | _____ |
| QUANTITY | _____ |
| DATE | _____ |

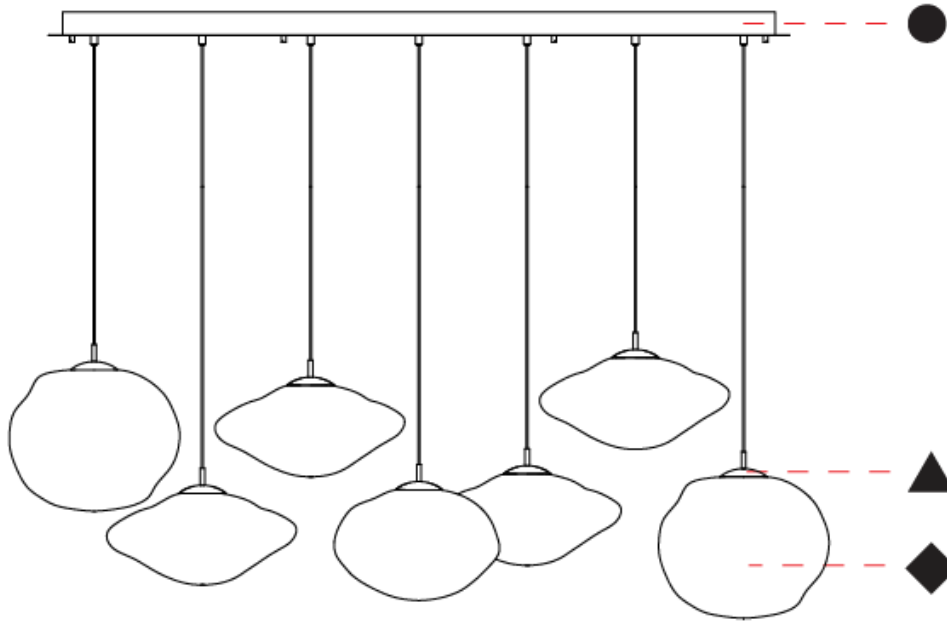

D

| |
|-----------|
| PROJECT |
| TYPE |
| SPECIFIER |
| QUANTITY |
| DATE |

MARK SURFACE

D142023-

| | | | |
|-------------|----------------------|-------------------|-------------------|
| base number | Color Temperature | Finish Options | Finish Options |
|-------------|----------------------|-------------------|-------------------|

- To build a product code in our configurator select the specify button on the base model # product page
- To build a manual product code on this datasheet choose from the options listed below in blue font and add the suffix to the base model #

GENERAL

| |
|-------------------------------|
| Series: Mark |
| Partner: Cangini & Tucci |
| Division: Design |
| Installation: Surface |
| Product Type: Ceiling Surface |
| Mounting Location: Ceiling |

PHYSICAL

| |
|---|
| Shape: Round |
| Diameter (mm): 250 |
| Diameter (in): 9 ¹³ / ₁₆ |
| Height (mm): 240 |
| Height (in): 9 ⁷ / ₁₆ |
| Weight (kg): 1.20 |
| Weight (lbs): 2.65 |
| Fixture Finish: AMB / BLK / BRZ / GLD / GRN / PNK / RGD / RUB / SKB / SMK / STE / TOB / TRA |
| Holder Finish: CHR / BCR / MWH / MBK |
| Fixture Material: Glass / Metal |
| Primary Material: Glass - Borosilicate |

ELECTRICAL

| |
|---|
| Lamp Type: LED |
| Input Wattage (W): 8.4 |
| Dimming: Tri-Mode (Non-Dimming and Phase Dimming (120Vac only) and 0-10V Dimming) |
| Driver Included: Yes |
| Driver Location: Integrated |
| Driver Type: Constant Current - Universal |
| Driver Class: Class 2 |
| Input Voltage (V): 120 |
| Constant Current (MA): 350mA |

LED

| |
|---|
| Number of LEDs: 1 |
| Color Temperature (°K): 2700 / 3000 |
| Nominal Lumen (lm): 1202 |
| CRI: >95 CRI |
| Efficacy (lm/w): 144 |
| Lamp Life (hrs): 50000 |

OPTICAL

RATINGS AND CERTIFICATIONS

| |
|--|
| Certified By: Certified for North American Standards |
| IP rating: IP20 |

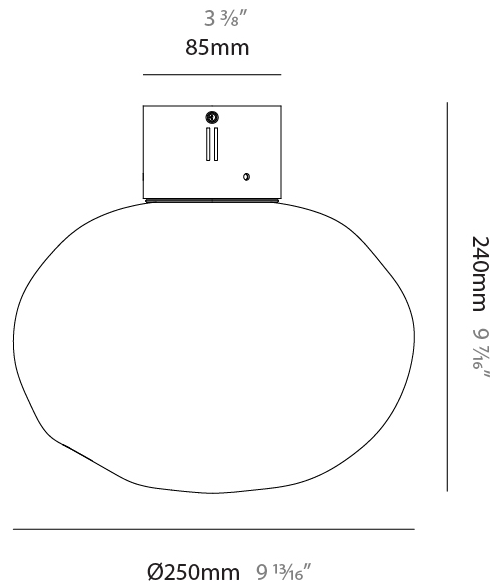

MARK SURFACE

D142023-

| | |
|-----------|-------|
| PROJECT | _____ |
| TYPE | _____ |
| SPECIFIER | _____ |
| QUANTITY | _____ |
| DATE | _____ |

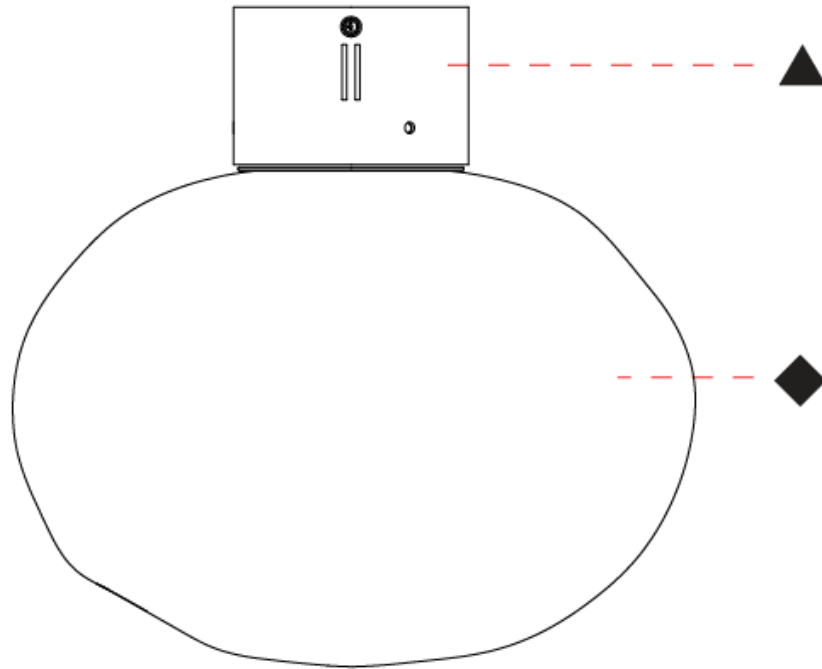

D

| |
|-----------|
| PROJECT |
| TYPE |
| SPECIFIER |
| QUANTITY |
| DATE |

MARK SURFACE

D142024-

base number Color Finish Finish
 Temperature Options Options

- To build a product code in our configurator select the specify button on the base model # product page
- To build a manual product code on this datasheet choose from the options listed below in blue font and add the suffix to the base model #

GENERAL

Series: Mark
 Partner: Cangini & Tucci
 Division: Design
 Installation: Surface
 Product Type: Ceiling Surface
 Mounting Location: Ceiling

PHYSICAL

Shape: Round
 Diameter (mm): 300
 Diameter (in): 11 ¹³/₁₆
 Height (mm): 310
 Height (in): 12 ³/₁₆
 Weight (kg): 1.50
 Weight (lbs): 3.31
 Diffuser: Glass
 Fixture Finish: [AMB](#) / [BLK](#) / [BRZ](#) / [GLD](#) / [GRN](#) / [PNK](#) / [RGD](#) / [RUB](#) / [SKB](#) / [SMK](#) / [STE](#) / [TOB](#) / [TRA](#)
 Holder Finish: [CHR](#) / [BCR](#) / [MWH](#) / [MBK](#)
 Fixture Material: Glass / Metal
 Primary Material: Glass - Borosilicate

ELECTRICAL

Lamp Type: LED
 Input Wattage (W): 8.4
 Dimming: Tri-Mode (Non-Dimming and Phase Dimming (120Vac only) and 0-10V Dimming)
 Driver Included: Yes
 Driver Location: Integrated
 Driver Type: Constant Current - Universal
 Driver Class: Class 2
 Input Voltage (V): 120
 Constant Current (MA): 350mA

LED

Number of LEDs: 1
 Color Temperature (°K): [2700](#) / [3000](#)
 Nominal Lumen (lm): 1202
 CRI: >95 CRI
 Efficacy (lm/w): 144
 Lamp Life (hrs): 50000

OPTICAL

RATINGS AND CERTIFICATIONS

Certified By: Certified for North American Standards
 IP rating: IP20

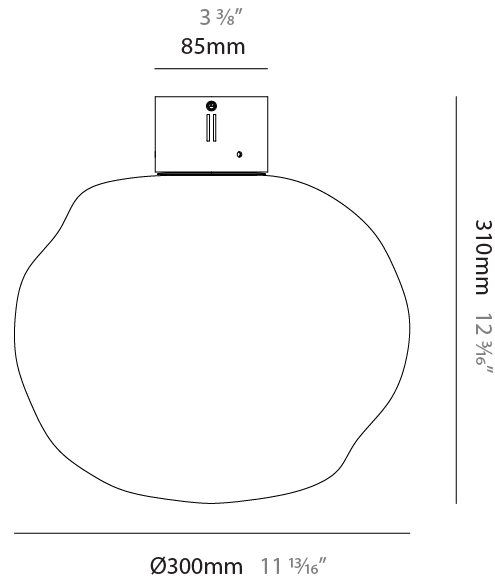

MARK SURFACE

D142024-

| | |
|-----------|-------|
| PROJECT | _____ |
| TYPE | _____ |
| SPECIFIER | _____ |
| QUANTITY | _____ |
| DATE | _____ |

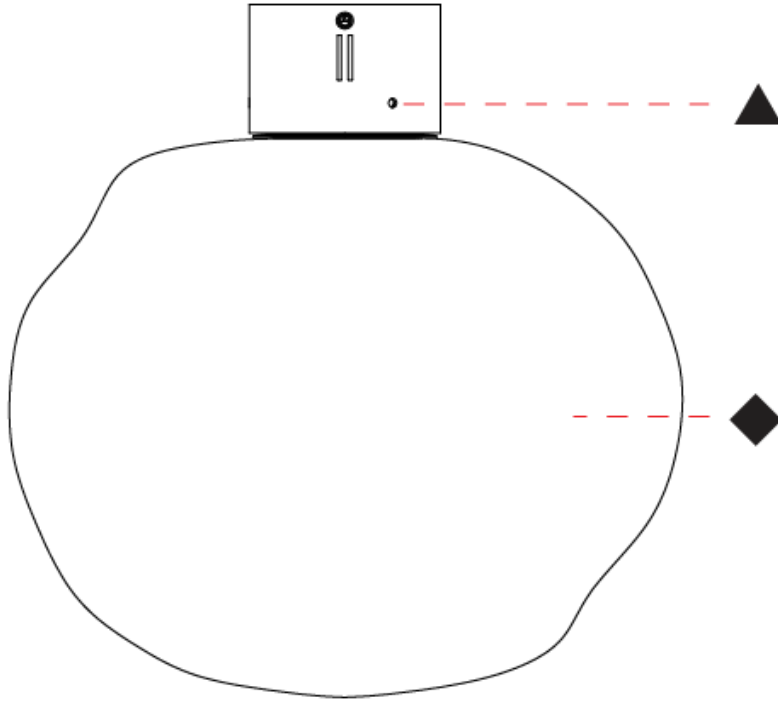

D

| |
|-----------|
| PROJECT |
| TYPE |
| SPECIFIER |
| QUANTITY |
| DATE |

MARK SURFACE

D142025-

base number Color Temperature Finish Options Finish Options

- To build a product code in our configurator select the specify button on the base model # product page
- To build a manual product code on this datasheet choose from the options listed below in blue font and add the suffix to the base model #

GENERAL

Series: Mark
 Partner: Cangini & Tucci
 Division: Design
 Installation: Surface
 Product Type: Ceiling Surface
 Mounting Location: Ceiling

PHYSICAL

Shape: Oval
 Diameter (mm): 250
 Diameter (in): 9 ¹³/₁₆
 Height (mm): 210
 Height (in): 8 ¹/₄
 Weight (kg): 1.20
 Weight (lbs): 2.65
 Diffuser: Glass
 Fixture Finish: [AMB](#) / [BLK](#) / [BRZ](#) / [GLD](#) / [GRN](#) / [PNK](#) / [RGD](#) / [RUB](#) / [SKB](#) / [SMK](#) / [STE](#) / [TOB](#) / [TRA](#)
 Holder Finish: [CHR](#) / [BCR](#) / [MWH](#) / [MBK](#)
 Fixture Material: Glass / Metal
 Primary Material: Glass - Borosilicate

ELECTRICAL

Lamp Type: LED
 Input Wattage (W): 8.4
 Dimming: Tri-Mode (Non-Dimming and Phase Dimming (120Vac only) and 0-10V Dimming)
 Driver Included: Yes
 Driver Location: Integrated
 Driver Type: Constant Current - Universal
 Driver Class: Class 2
 Input Voltage (V): 120
 Constant Current (MA): 350mA

LED

Number of LEDs: 1
 Color Temperature (°K): [2700](#) / [3000](#)
 Nominal Lumen (lm): 1202
 CRI: >95 CRI
 Efficacy (lm/w): 144
 Lamp Life (hrs): 50000

OPTICAL

RATINGS AND CERTIFICATIONS

Certified By: Certified for North American Standards
 IP rating: IP20

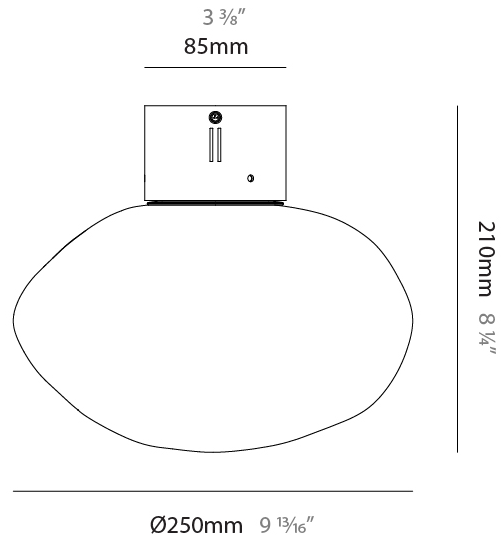

MARK SURFACE

D142025-

| | |
|-----------|-------|
| PROJECT | _____ |
| TYPE | _____ |
| SPECIFIER | _____ |
| QUANTITY | _____ |
| DATE | _____ |

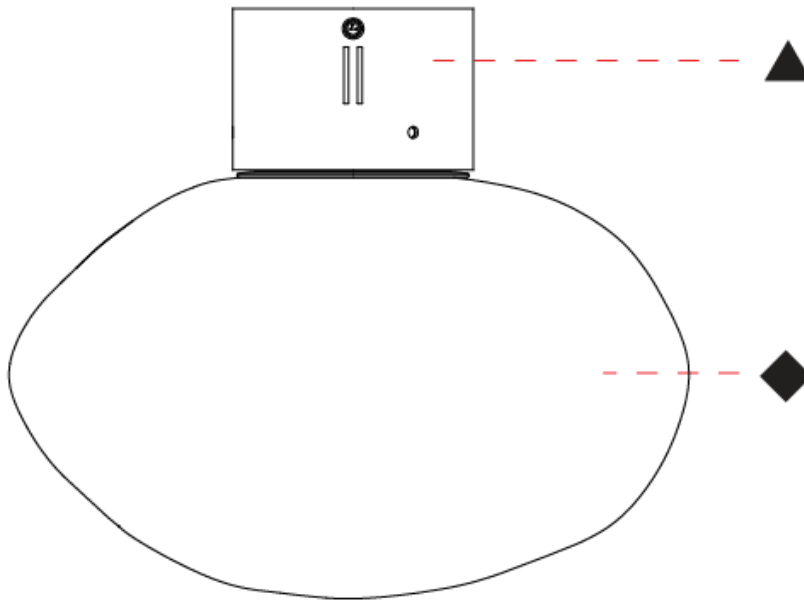

D

| |
|-----------|
| PROJECT |
| TYPE |
| SPECIFIER |
| QUANTITY |
| DATE |

MARK SURFACE

D142026-

base number Color Finish Finish
Temperature Options Options

- To build a product code in our configurator select the specify button on the base model # product page
- To build a manual product code on this datasheet choose from the options listed below in blue font and add the suffix to the base model #

GENERAL

Series: Mark
 Partner: Cangini & Tucci
 Division: Design
 Installation: Surface
 Product Type: Ceiling Surface
 Mounting Location: Ceiling

PHYSICAL

Shape: Oval
 Diameter (mm): 300
 Diameter (in): 11 ¹³/₁₆
 Height (mm): 260
 Height (in): 10 ¹/₄
 Weight (kg): 1.50
 Weight (lbs): 3.31
 Diffuser: Glass
 Fixture Finish: [AMB](#) / [BLK](#) / [BRZ](#) / [GLD](#) / [GRN](#) / [PNK](#) / [RGD](#) / [RUB](#) / [SKB](#) / [SMK](#) / [STE](#) / [TOB](#) / [TRA](#)
 Holder Finish: [CHR](#) / [BCR](#) / [MWH](#) / [MBK](#)
 Fixture Material: Glass / Metal
 Primary Material: Glass - Borosilicate

ELECTRICAL

Lamp Type: LED
 Input Wattage (W): 8.4
 Dimming: Tri-Mode (Non-Dimming and Phase Dimming (120Vac only) and 0-10V Dimming)
 Driver Included: Yes
 Driver Location: Integrated
 Driver Type: Constant Current - Universal
 Driver Class: Class 2
 Input Voltage (V): 120
 Constant Current (MA): 350mA

LED

Number of LEDs: 1
 Color Temperature (°K): [2700](#) / [3000](#)
 Nominal Lumen (lm): 1202
 CRI: >95 CRI
 Efficacy (lm/w): 144
 Lamp Life (hrs): 50000

OPTICAL

RATINGS AND CERTIFICATIONS

Certified By: Certified for North American Standards
 IP rating: IP20

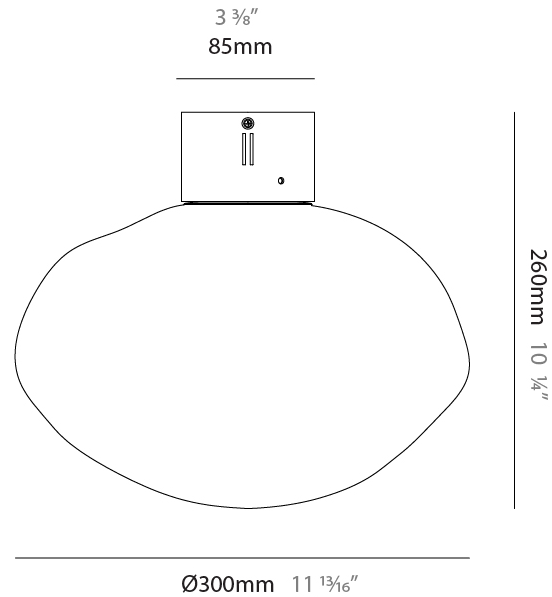

MARK SURFACE

D142026-

PROJECT _____

TYPE _____

SPECIFIER _____

QUANTITY _____

DATE _____

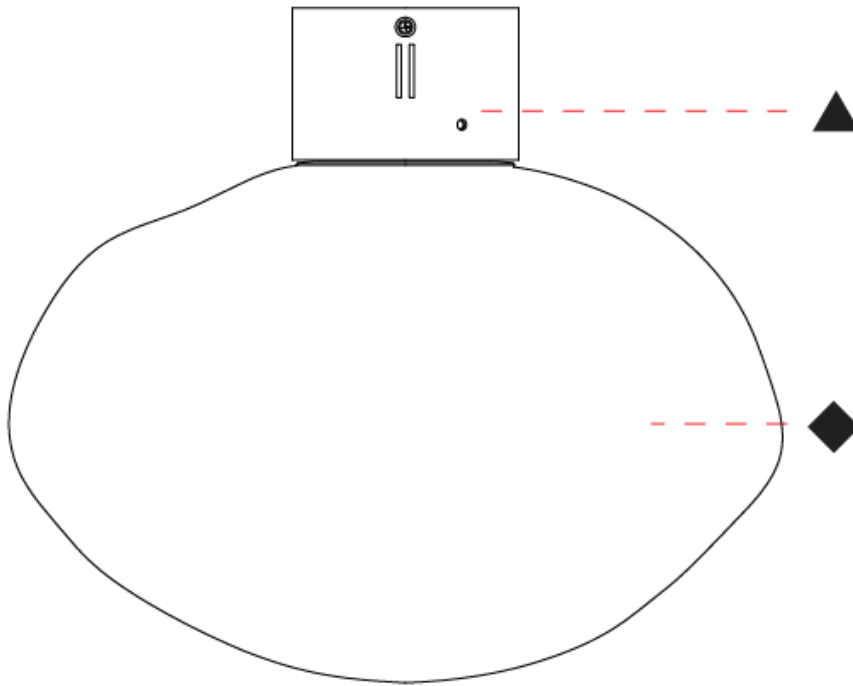

D

| |
|-----------|
| PROJECT |
| TYPE |
| SPECIFIER |
| QUANTITY |
| DATE |

MARK SURFACE

D142027-

| | | | |
|-------------|----------------------|-------------------|-------------------|
| base number | Color Temperature | Finish Options | Finish Options |
|-------------|----------------------|-------------------|-------------------|

- To build a product code in our configurator select the specify button on the base model # product page
- To build a manual product code on this datasheet choose from the options listed below in blue font and add the suffix to the base model #

GENERAL

| |
|-------------------------------|
| Series: Mark |
| Partner: Cangini & Tucci |
| Division: Design |
| Installation: Surface |
| Product Type: Ceiling Surface |
| Mounting Location: Ceiling |

PHYSICAL

| |
|---|
| Shape: Oval |
| Diameter (mm): 300 |
| Diameter (in): 11 ¹³ / ₁₆ |
| Height (mm): 200 |
| Height (in): 7 ⁷ / ₈ |
| Weight (kg): 1.20 |
| Weight (lbs): 2.65 |
| Diffuser: Glass |
| Fixture Finish: AMB / BLK / BRZ / GLD / GRN / PNK / RGD / RUB / SKB / SMK / STE / TOB / TRA |
| Holder Finish: CHR / BCR / MWH / MBK |
| Fixture Material: Glass / Metal |
| Primary Material: Glass - Borosilicate |

ELECTRICAL

| |
|---|
| Lamp Type: LED |
| Input Wattage (W): 8.4 |
| Dimming: Tri-Mode (Non-Dimming and Phase Dimming (120Vac only) and 0-10V Dimming) |
| Driver Included: Yes |
| Driver Location: Integrated |
| Driver Type: Constant Current - Universal |
| Driver Class: Class 2 |
| Input Voltage (V): 120 |
| Constant Current (MA): 350mA |

LED

| |
|---|
| Number of LEDs: 1 |
| Color Temperature (°K): 2700 / 3000 |
| Nominal Lumen (lm): 1202 |
| CRI: >95 CRI |
| Efficacy (lm/w): 144 |
| Lamp Life (hrs): 50000 |

OPTICAL

RATINGS AND CERTIFICATIONS

| |
|--|
| Certified By: Certified for North American Standards |
| IP rating: IP20 |

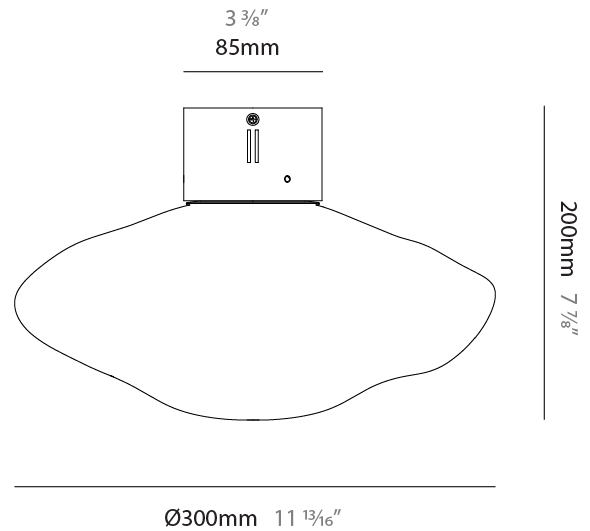

MARK SURFACE

D142027-

| | |
|-----------|-------|
| PROJECT | _____ |
| TYPE | _____ |
| SPECIFIER | _____ |
| QUANTITY | _____ |
| DATE | _____ |

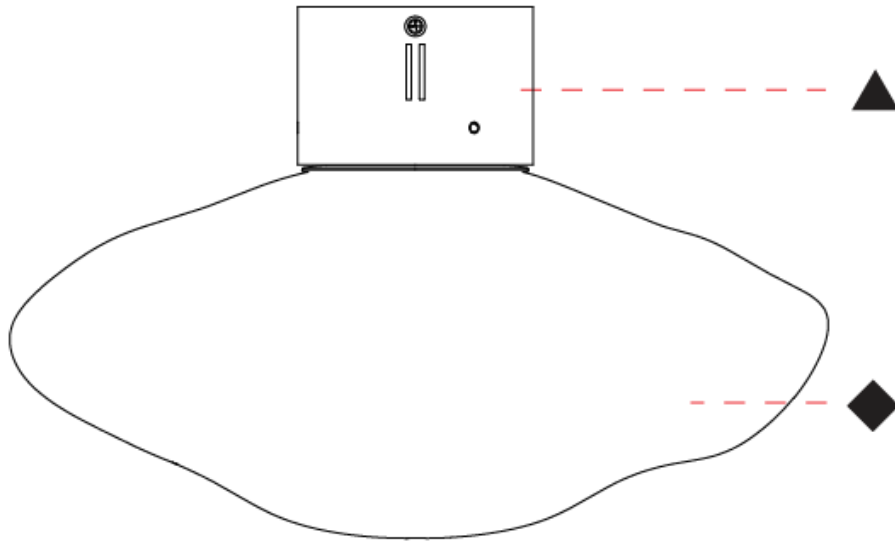

D

| |
|-----------|
| PROJECT |
| TYPE |
| SPECIFIER |
| QUANTITY |
| DATE |

MARK SURFACE

D142028-

| | | | |
|-------------|----------------------|-------------------|-------------------|
| base number | Color Temperature | Finish Options | Finish Options |
|-------------|----------------------|-------------------|-------------------|

- To build a product code in our configurator select the specify button on the base model # product page
- To build a manual product code on this datasheet choose from the options listed below in blue font and add the suffix to the base model #

GENERAL

| |
|-------------------------------|
| Series: Mark |
| Partner: Cangini & Tucci |
| Division: Design |
| Installation: Surface |
| Product Type: Ceiling Surface |
| Mounting Location: Ceiling |

PHYSICAL

| |
|---|
| Shape: Oval |
| Diameter (mm): 350 |
| Diameter (in): 13 ³ / ₄ |
| Height (mm): 220 |
| Height (in): 8 ¹¹ / ₁₆ |
| Weight (kg): 1.50 |
| Weight (lbs): 3.31 |
| Diffuser: Glass |
| Fixture Finish: AMB / BLK / BRZ / GLD / GRN / PNK / RGD / RUB / SKB / SMK / STE / TOB / TRA |
| Holder Finish: CHR / BCR / MWH / MBK |
| Fixture Material: Glass / Metal |
| Primary Material: Glass - Borosilicate |

ELECTRICAL

| |
|---|
| Lamp Type: LED |
| Input Wattage (W): 8.4 |
| Dimming: Tri-Mode (Non-Dimming and Phase Dimming (120Vac only) and 0-10V Dimming) |
| Driver Included: Yes |
| Driver Location: Integrated |
| Driver Type: Constant Current - Universal |
| Driver Class: Class 2 |
| Input Voltage (V): 120 |
| Constant Current (MA): 350mA |

LED

| |
|---|
| Number of LEDs: 1 |
| Color Temperature (°K): 2700 / 3000 |
| Nominal Lumen (lm): 1202 |
| CRI: >95 CRI |
| Efficacy (lm/w): 144 |
| Lamp Life (hrs): 50000 |

OPTICAL

RATINGS AND CERTIFICATIONS

| |
|--|
| Certified By: Certified for North American Standards |
| IP rating: IP20 |

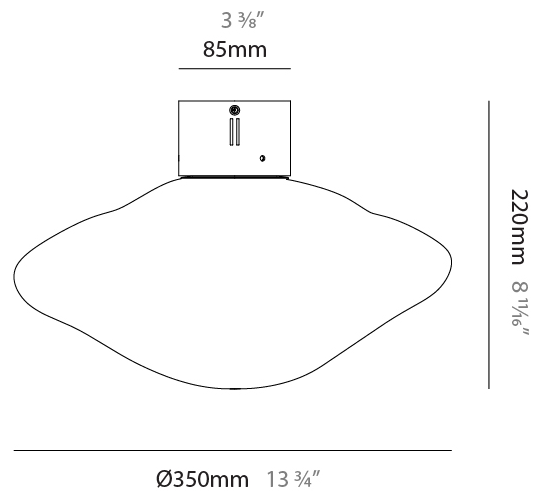

MARK SURFACE

D142028-

| | |
|-----------|-------|
| PROJECT | _____ |
| TYPE | _____ |
| SPECIFIER | _____ |
| QUANTITY | _____ |
| DATE | _____ |

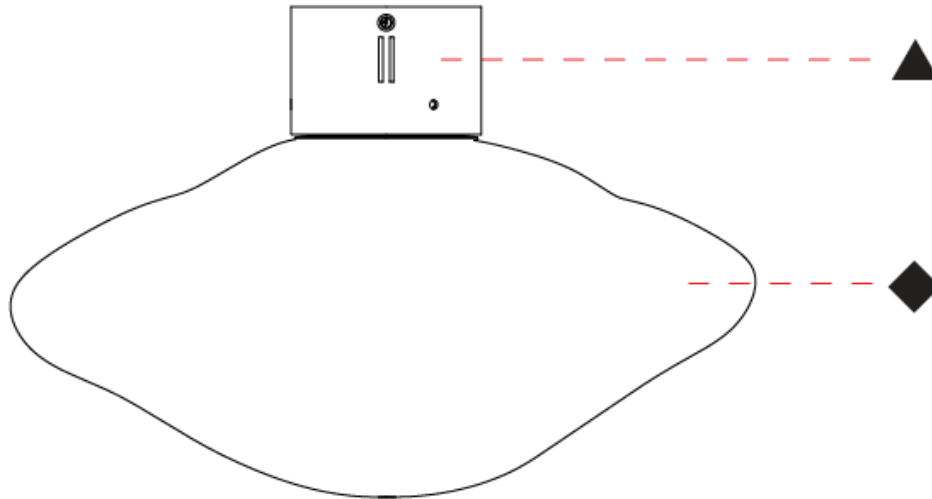

D

| | |
|-----------|-------|
| PROJECT | _____ |
| TYPE | _____ |
| SPECIFIER | _____ |
| QUANTITY | _____ |
| DATE | _____ |

MARK SURFACE

D143040-

| | | | |
|-------------|-------------|---------|---------|
| base number | Color | Finish | Finish |
| | Temperature | Options | Options |

- To build a product code in our configurator select the specify button on the base model # product page
- To build a manual product code on this datasheet choose from the options listed below in blue font and add the suffix to the base model #

GENERAL

| |
|----------------------------|
| Series: Mark |
| Partner: Cangini & Tucci |
| Division: Design |
| Installation: Surface |
| Product Type: Wall Surface |
| Mounting Location: Wall |

PHYSICAL

| |
|---|
| Shape: Round |
| Diameter (mm): 250 |
| Diameter (in): 9 ¹³ / ₁₆ |
| Height (mm): 240 |
| Height (in): 9 ⁷ / ₁₆ |
| Weight (kg): 1.20 |
| Weight (lbs): 2.65 |
| Fixture Finish: AMB / BLK / BRZ / GLD / GRN / PNK / RGD / RUB / SKB / SMK / STE / TOB / TRA |
| Holder Finish: CHR / BCR / MWH / MBK |
| Fixture Material: Glass / Metal |
| Primary Material: Glass - Borosilicate |

ELECTRICAL

| |
|---|
| Lamp Type: LED |
| Input Wattage (W): 8.4 |
| Dimming: Tri-Mode (Non-Dimming and Phase Dimming (120Vac only) and 0-10V Dimming) |
| Driver Included: Yes |
| Driver Location: Integrated |
| Driver Type: Constant Current - Universal |
| Driver Class: Class 2 |
| Input Voltage (V): 120 |
| Constant Current (MA): 350mA |

LED

| |
|---|
| Number of LEDs: 1 |
| Color Temperature (°K): 2700 / 3000 |
| Nominal Lumen (lm): 1202 |
| CRI: >95 CRI |
| Efficacy (lm/w): 144 |
| Lamp Life (hrs): 50000 |

OPTICAL

RATINGS AND CERTIFICATIONS

| |
|--|
| Certified By: Certified for North American Standards |
| IP rating: IP20 |

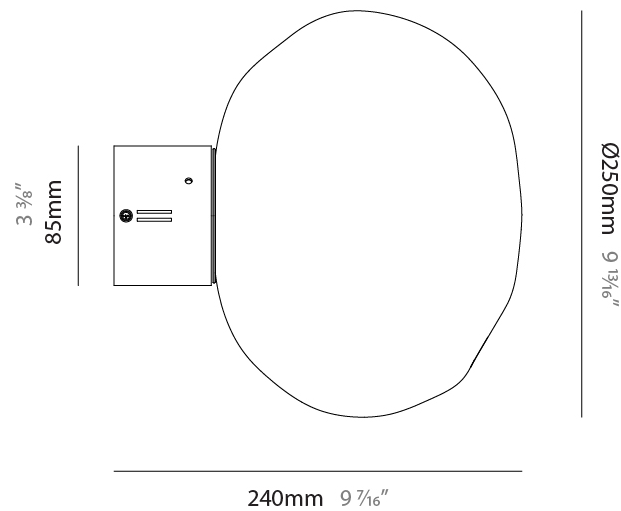

MARK SURFACE

D143040-

| | |
|-----------|-------|
| PROJECT | _____ |
| TYPE | _____ |
| SPECIFIER | _____ |
| QUANTITY | _____ |
| DATE | _____ |

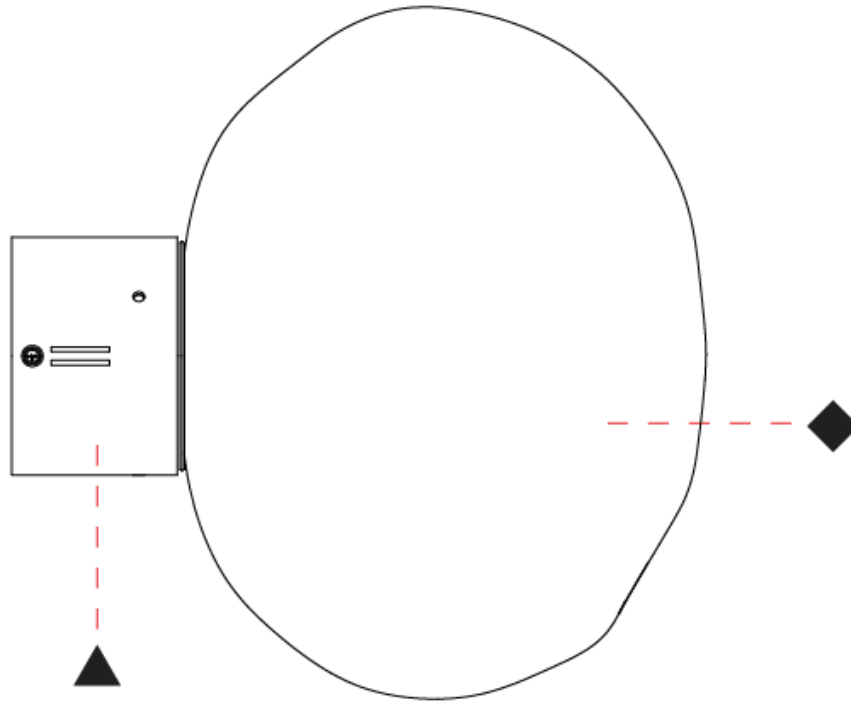

D

| | |
|-----------|-------|
| PROJECT | _____ |
| TYPE | _____ |
| SPECIFIER | _____ |
| QUANTITY | _____ |
| DATE | _____ |

MARK SURFACE

D143041-

| | | | |
|-------------|----------------------|-------------------|-------------------|
| base number | Color Temperature | Finish Options | Finish Options |
|-------------|----------------------|-------------------|-------------------|

- To build a product code in our configurator select the specify button on the base model # product page
- To build a manual product code on this datasheet choose from the options listed below in blue font and add the suffix to the base model #

GENERAL

| |
|----------------------------|
| Series: Mark |
| Partner: Cangini & Tucci |
| Division: Design |
| Installation: Surface |
| Product Type: Wall Surface |
| Mounting Location: Wall |

PHYSICAL

| |
|---|
| Shape: Round |
| Diameter (mm): 300 |
| Diameter (in): 11 ¹³ / ₁₆ |
| Height (mm): 310 |
| Height (in): 12 ³ / ₁₆ |
| Weight (kg): 1.50 |
| Weight (lbs): 3.31 |
| Diffuser: Glass |
| Fixture Finish: AMB / BLK / BRZ / GLD / GRN / PNK / RGD / RUB / SKB / SMK / STE / TOB / TRA |
| Holder Finish: CHR / BCR / MWH / MBK |
| Fixture Material: Glass / Metal |
| Primary Material: Glass - Borosilicate |

ELECTRICAL

| |
|---|
| Lamp Type: LED |
| Input Wattage (W): 8.4 |
| Dimming: Tri-Mode (Non-Dimming and Phase Dimming (120Vac only) and 0-10V Dimming) |
| Driver Included: Yes |
| Driver Location: Integrated |
| Driver Type: Constant Current - Universal |
| Driver Class: Class 2 |
| Input Voltage (V): 120 |
| Constant Current (MA): 350mA |

LED

| |
|---|
| Number of LEDs: 1 |
| Color Temperature (°K): 2700 / 3000 |
| Nominal Lumen (lm): 1202 |
| CRI: >95 CRI |
| Efficacy (lm/w): 144 |
| Lamp Life (hrs): 50000 |

OPTICAL

RATINGS AND CERTIFICATIONS

| |
|--|
| Certified By: Certified for North American Standards |
| IP rating: IP20 |

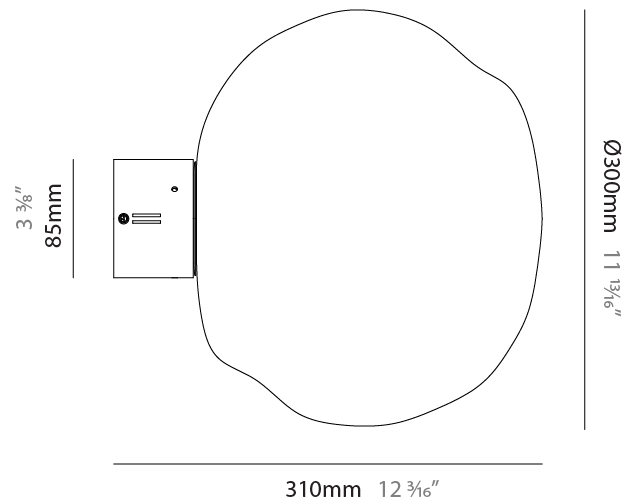

MARK SURFACE

D143041-

PROJECT _____

TYPE _____

SPECIFIER _____

QUANTITY _____

DATE _____

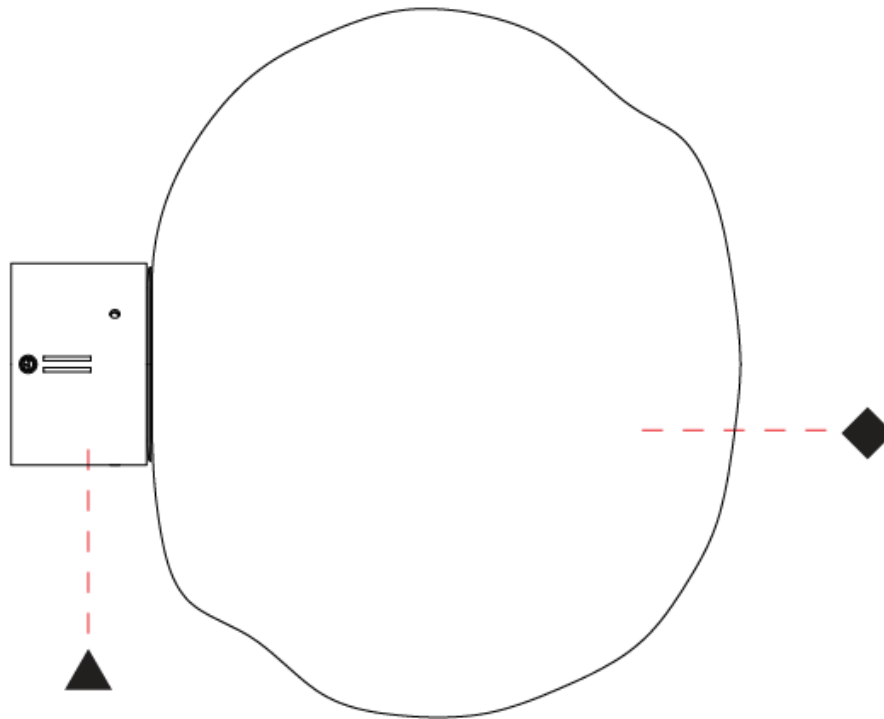

D

| | |
|-----------|-------|
| PROJECT | _____ |
| TYPE | _____ |
| SPECIFIER | _____ |
| QUANTITY | _____ |
| DATE | _____ |

MARK SURFACE

D143042-

| | | | |
|-------------|-------------|---------|---------|
| base number | Color | Finish | Finish |
| | Temperature | Options | Options |

- To build a product code in our configurator select the specify button on the base model # product page
- To build a manual product code on this datasheet choose from the options listed below in blue font and add the suffix to the base model #

GENERAL

| |
|----------------------------|
| Series: Mark |
| Partner: Cangini & Tucci |
| Division: Design |
| Installation: Surface |
| Product Type: Wall Surface |
| Mounting Location: Wall |

PHYSICAL

| |
|---|
| Shape: Oval |
| Diameter (mm): 250 |
| Diameter (in): 9 ¹³ / ₁₆ |
| Height (mm): 210 |
| Height (in): 8 ¹ / ₄ |
| Weight (kg): 1.20 |
| Weight (lbs): 2.65 |
| Diffuser: Glass |
| Fixture Finish: AMB / BLK / BRZ / GLD / GRN / PNK / RGD / RUB / SKB / SMK / STE / TOB / TRA |
| Holder Finish: CHR / BCR / MWH / MBK |
| Fixture Material: Glass / Metal |
| Primary Material: Glass - Borosilicate |

ELECTRICAL

| |
|---|
| Lamp Type: LED |
| Input Wattage (W): 8.4 |
| Dimming: Tri-Mode (Non-Dimming and Phase Dimming (120Vac only) and 0-10V Dimming) |
| Driver Included: Yes |
| Driver Location: Integrated |
| Driver Type: Constant Current - Universal |
| Driver Class: Class 2 |
| Input Voltage (V): 120 |
| Constant Current (MA): 350mA |

LED

| |
|---|
| Number of LEDs: 1 |
| Color Temperature (°K): 2700 / 3000 |
| Nominal Lumen (lm): 1202 |
| CRI: >95 CRI |
| Efficacy (lm/w): 144 |
| Lamp Life (hrs): 50000 |

OPTICAL

RATINGS AND CERTIFICATIONS

| |
|--|
| Certified By: Certified for North American Standards |
| IP rating: IP20 |

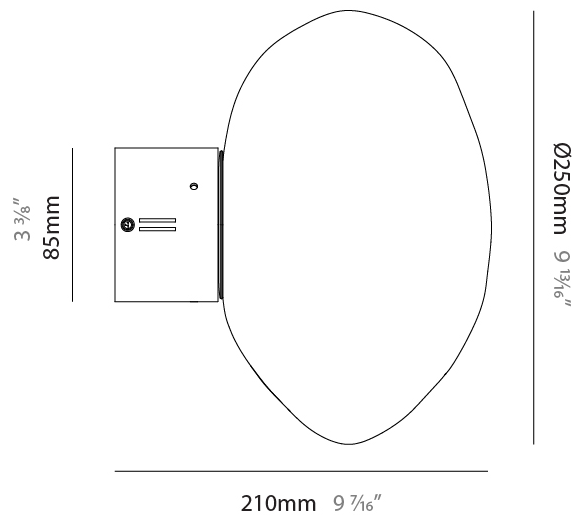

MARK SURFACE

D143042-

PROJECT

TYPE

SPECIFIER

QUANTITY

DATE

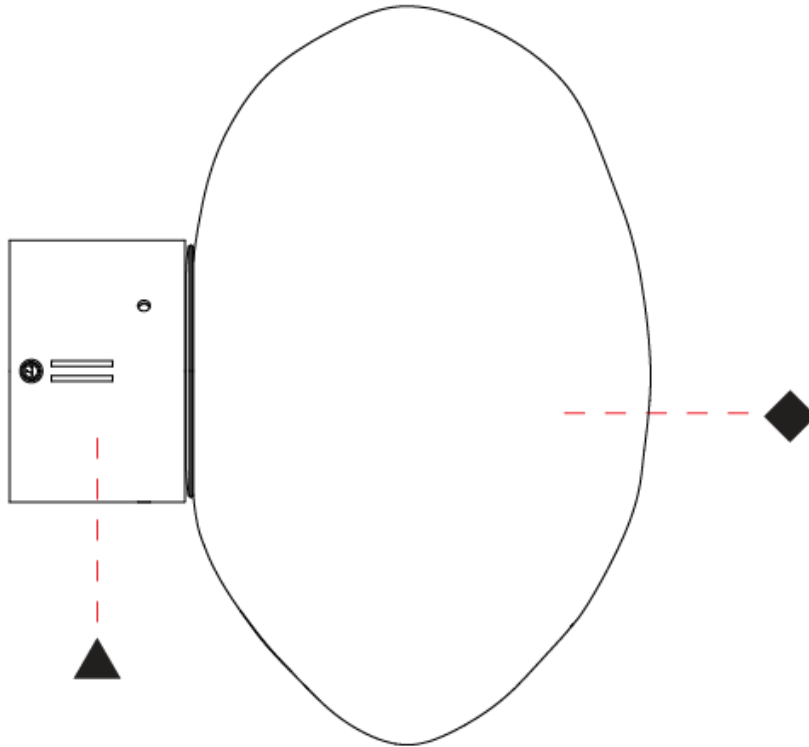

D

| | |
|-----------|--|
| PROJECT | |
| TYPE | |
| SPECIFIER | |
| QUANTITY | |
| DATE | |

MARK SURFACE

D143043-

| | | | |
|-------------|----------------------|-------------------|-------------------|
| base number | Color Temperature | Finish Options | Finish Options |
|-------------|----------------------|-------------------|-------------------|

- To build a product code in our configurator select the specify button on the base model # product page
- To build a manual product code on this datasheet choose from the options listed below in blue font and add the suffix to the base model #

GENERAL

| |
|----------------------------|
| Series: Mark |
| Partner: Cangini & Tucci |
| Division: Design |
| Installation: Surface |
| Product Type: Wall Surface |
| Mounting Location: Wall |

PHYSICAL

| |
|---|
| Shape: Oval |
| Diameter (mm): 300 |
| Diameter (in): 11 ¹³ / ₁₆ |
| Height (mm): 260 |
| Height (in): 10 ¹ / ₄ |
| Weight (kg): 1.50 |
| Weight (lbs): 3.31 |
| Diffuser: Glass |
| Fixture Finish: AMB / BLK / BRZ / GLD / GRN / PNK / RGD / RUB / SKB / SMK / STE / TOB / TRA |
| Holder Finish: CHR / BCR / MWH / MBK |
| Fixture Material: Glass / Metal |
| Primary Material: Glass - Borosilicate |

ELECTRICAL

| |
|---|
| Lamp Type: LED |
| Input Wattage (W): 8.4 |
| Dimming: Tri-Mode (Non-Dimming and Phase Dimming (120Vac only) and 0-10V Dimming) |
| Driver Included: Yes |
| Driver Location: Integrated |
| Driver Type: Constant Current - Universal |
| Driver Class: Class 2 |
| Input Voltage (V): 120 |
| Constant Current (MA): 350mA |

LED

| |
|---|
| Number of LEDs: 1 |
| Color Temperature (°K): 2700 / 3000 |
| Nominal Lumen (lm): 1202 |
| CRI: >95 CRI |
| Efficacy (lm/w): 144 |
| Lamp Life (hrs): 50000 |

OPTICAL

RATINGS AND CERTIFICATIONS

| |
|--|
| Certified By: Certified for North American Standards |
| IP rating: IP20 |

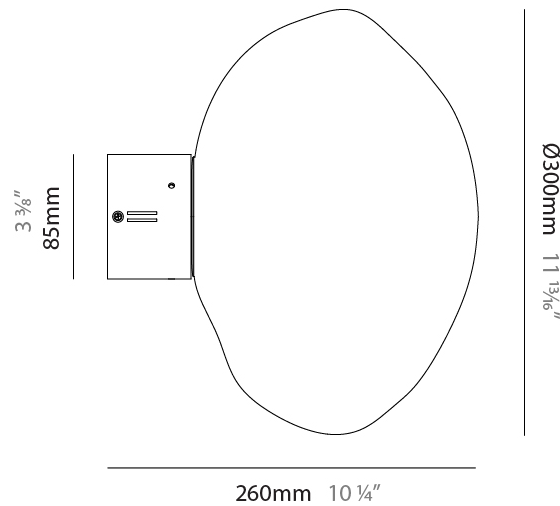

MARK SURFACE

D143043-

| |
|-----------|
| PROJECT |
| TYPE |
| SPECIFIER |
| QUANTITY |
| DATE |

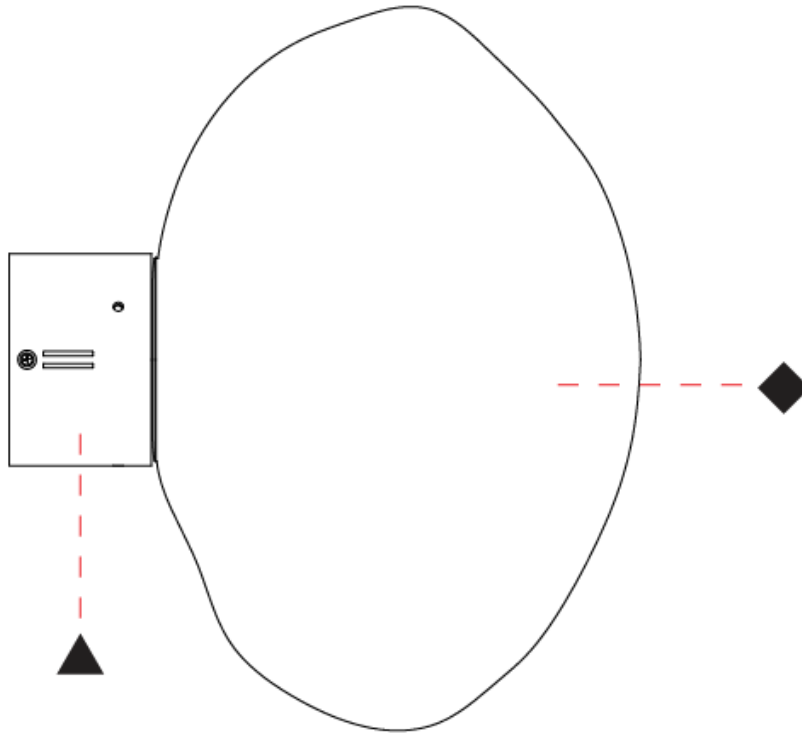

D

| |
|-----------|
| PROJECT |
| TYPE |
| SPECIFIER |
| QUANTITY |
| DATE |

MARK SURFACE

D143044-

| | | | |
|-------------|----------------------|-------------------|-------------------|
| base number | Color Temperature | Finish Options | Finish Options |
|-------------|----------------------|-------------------|-------------------|

- To build a product code in our configurator select the specify button on the base model # product page
- To build a manual product code on this datasheet choose from the options listed below in blue font and add the suffix to the base model #

GENERAL

| |
|----------------------------|
| Series: Mark |
| Partner: Cangini & Tucci |
| Division: Design |
| Installation: Surface |
| Product Type: Wall Surface |
| Mounting Location: Wall |

PHYSICAL

| |
|---|
| Shape: Oval |
| Diameter (mm): 300 |
| Diameter (in): 11 ¹³ / ₁₆ |
| Height (mm): 200 |
| Height (in): 7 ⁷ / ₈ |
| Weight (kg): 1.20 |
| Weight (lbs): 2.65 |
| Diffuser: Glass |
| Fixture Finish: AMB / BLK / BRZ / GLD / GRN / PNK / RGD / RUB / SKB / SMK / STE / TOB / TRA |
| Holder Finish: CHR / BCR / MWH / MBK |
| Fixture Material: Glass / Metal |
| Primary Material: Glass - Borosilicate |

ELECTRICAL

| |
|---|
| Lamp Type: LED |
| Input Wattage (W): 8.4 |
| Dimming: Tri-Mode (Non-Dimming and Phase Dimming (120Vac only) and 0-10V Dimming) |
| Driver Included: Yes |
| Driver Location: Integrated |
| Driver Type: Constant Current - Universal |
| Driver Class: Class 2 |
| Input Voltage (V): 120 |
| Constant Current (MA): 350mA |

LED

| |
|---|
| Number of LEDs: 1 |
| Color Temperature (°K): 2700 / 3000 |
| Nominal Lumen (lm): 1202 |
| CRI: >95 CRI |
| Efficacy (lm/w): 144 |
| Lamp Life (hrs): 50000 |

OPTICAL

RATINGS AND CERTIFICATIONS

| |
|--|
| Certified By: Certified for North American Standards |
| IP rating: IP20 |

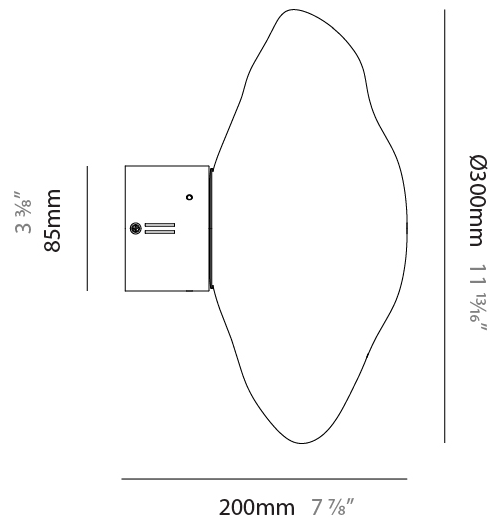

MARK SURFACE

D143044-

| |
|-----------|
| PROJECT |
| TYPE |
| SPECIFIER |
| QUANTITY |
| DATE |

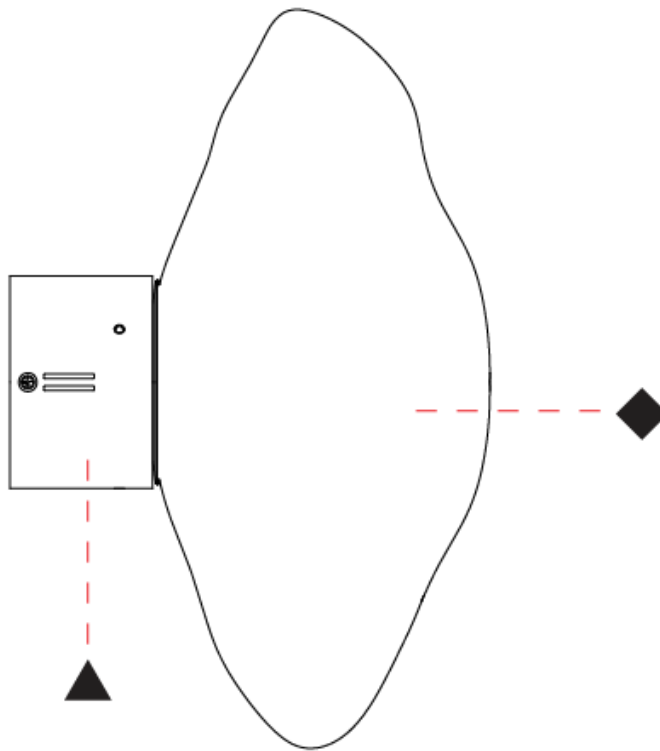

MARK SURFACE

D143045-

base number Color Finish Finish
 Temperature Options Options

- To build a product code in our configurator select the specify button on the base model # product page
- To build a manual product code on this datasheet choose from the options listed below in blue font and add the suffix to the base model #

GENERAL

Series: Mark
 Partner: Cangini & Tucci
 Division: Design
 Installation: Surface
 Product Type: Wall Surface
 Mounting Location: Wall

PHYSICAL

Shape: Oval
 Diameter (mm): 350
 Diameter (in): 13 3/4
 Height (mm): 220
 Height (in): 8 11/16
 Weight (kg): 1.50
 Weight (lbs): 3.31
 Diffuser: Glass
 Fixture Finish: [AMB / BLK / BRZ / GLD / GRN / PNK / RGD / RUB / SKB / SMK / STE / TOB / TRA](#)
 Holder Finish: [CHR / BCR / MWH / MBK](#)
 Fixture Material: Glass / Metal
 Primary Material: Glass - Borosilicate

ELECTRICAL

Lamp Type: LED
 Input Wattage (W): 8.4
 Dimming: Tri-Mode (Non-Dimming and Phase Dimming (120Vac only) and 0-10V Dimming)
 Driver Included: Yes
 Driver Location: Integrated
 Driver Type: Constant Current - Universal
 Driver Class: Class 2
 Input Voltage (V): 120
 Constant Current (MA): 350mA

LED

Number of LEDs: 1
 Color Temperature (°K): [2700 / 3000](#)
 Nominal Lumen (lm): 1202
 CRI: >95 CRI
 Efficacy (lm/w): 144
 Lamp Life (hrs): 50000

OPTICAL

RATINGS AND CERTIFICATIONS

Certified By: Certified for North American Standards
 IP rating: IP20

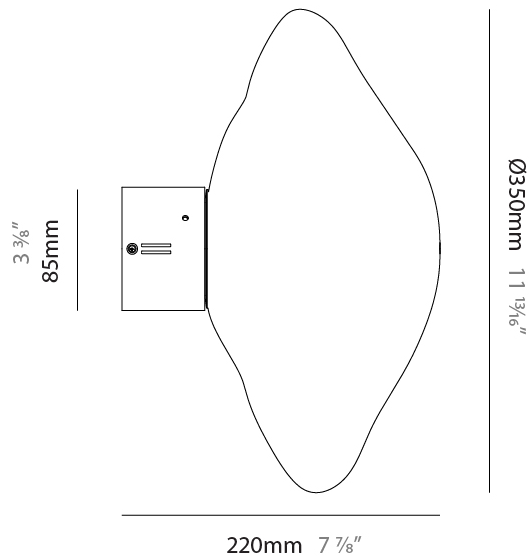

MARK SURFACE

D143045-

PROJECT

TYPE

SPECIFIER

QUANTITY

DATE

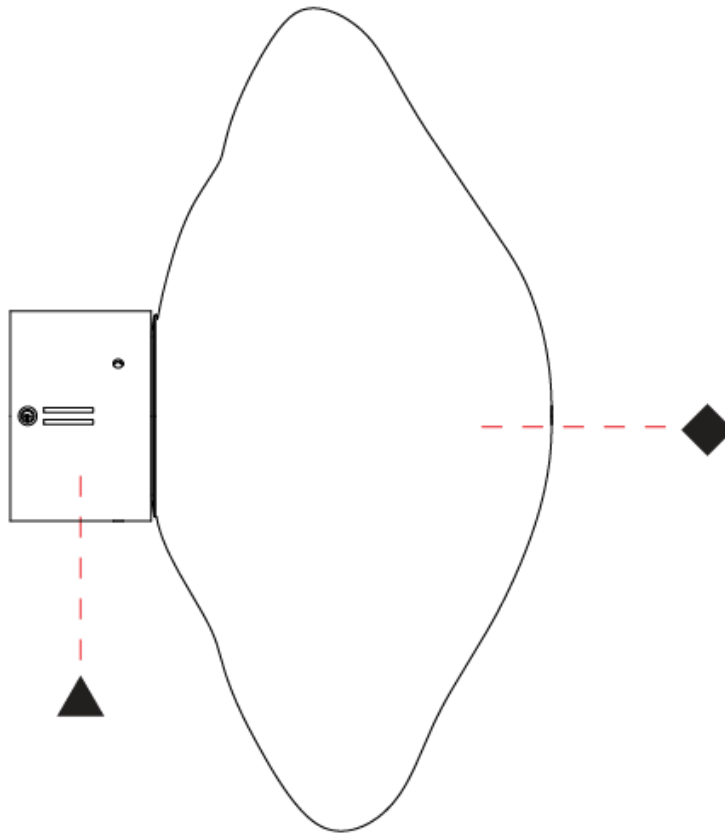

MARK PORTABLE

D144049-

base number Color Finish Finish
 Temperature Options Options

- To build a product code in our configurator select the specify button on the base model # product page
- To build a manual product code on this datasheet choose from the options listed below in blue font and add the suffix to the base model #

GENERAL

Series: Mark
 Partner: Cangini & Tucci
 Division: Design
 Installation: Portable
 Product Type: Table
 Mounting Location: Table

PHYSICAL

Shape: Round
 Diameter (mm): 250
 Diameter (in): 9 ¹³/₁₆
 Height (mm): 520
 Height (in): 20 ¹/₂
 Weight (kg): 6.50
 Weight (lbs): 14.33
 Fixture Finish: [AMB / BLK / BRZ / GLD / GRN / PNK / RGD / RUB / SKB / SMK / STE / TOB / TRA](#)
 Holder Finish: [SGD / SBK](#)
 Fixture Material: Glass / Metal
 Primary Material: Glass - Borosilicate
 Cable Details: 2000mm/78 3/4" Transparent Cable

ELECTRICAL

Lamp Type: LED
 Input Wattage (W): 6
 Dimming: Tri-Mode (Non-Dimming and Phase Dimming (120Vac only) and 0-10V Dimming)
 Driver Included: Yes
 Driver Location: Integrated
 Driver Type: Constant Current - Universal
 Driver Class: Class 2
 Input Voltage (V): 120
 Constant Current (MA): 500mA

LED

Number of LEDs: 1
 Color Temperature (°K): [2700 / 3000](#)
 Nominal Lumen (lm): 866
 CRI: >95 CRI
 Lamp Life (hrs): 50000

OPTICAL

RATINGS AND CERTIFICATIONS

Certified By: Certified for North American Standards
 IP rating: IP20

| |
|-----------|
| PROJECT |
| TYPE |
| SPECIFIER |
| QUANTITY |
| DATE |

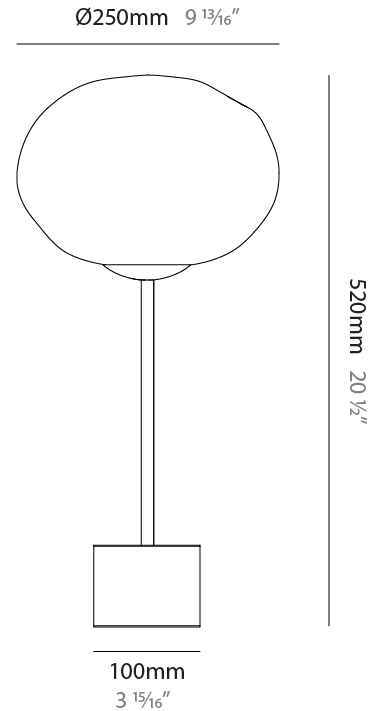

D144049-

PROJECT

TYPE

SPECIFIER

QUANTITY

DATE

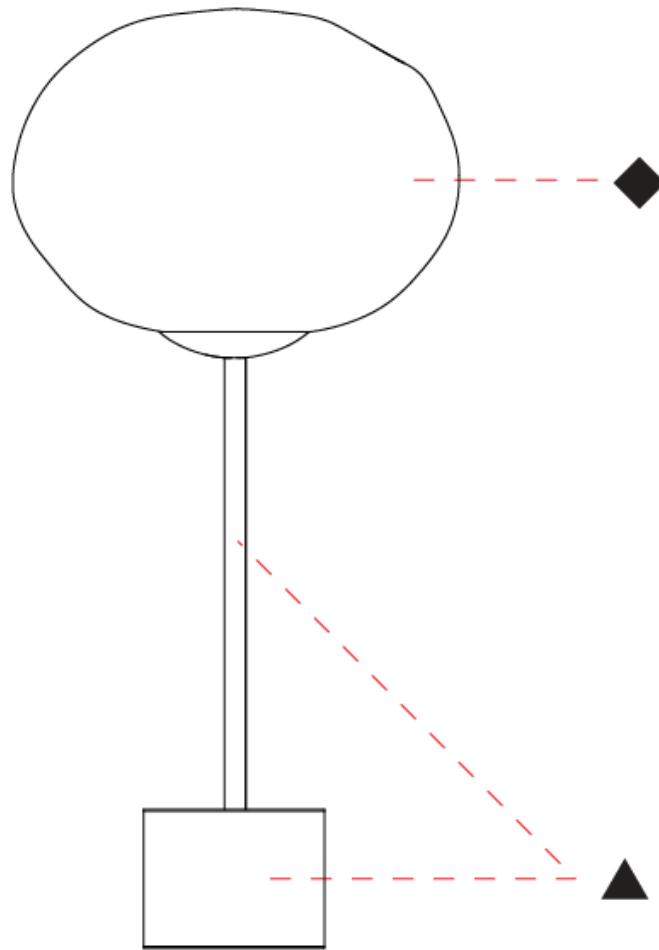

D

MARK PORTABLE

D144050-

base number Color Finish Finish
 Temperature Options Options

- To build a product code in our configurator select the specify button on the base model # product page
- To build a manual product code on this datasheet choose from the options listed below in blue font and add the suffix to the base model #

GENERAL

Series: Mark
 Partner: Cangini & Tucci
 Division: Design
 Installation: Portable
 Product Type: Table
 Mounting Location: Table

PHYSICAL

Shape: Oval
 Diameter (mm): 300
 Diameter (in): 11 ¹³/₁₆
 Height (mm): 480
 Height (in): 18 ⁷/₈
 Weight (kg): 6.50
 Weight (lbs): 14.33
 Fixture Finish: [AMB / BLK / BRZ / GLD / GRN / PNK / RGD / RUB / SKB / SMK / STE / TOB / TRA](#)
 Holder Finish: [SGD / SBK](#)
 Fixture Material: Glass / Metal
 Primary Material: Glass - Borosilicate
 Cable Details: 2000mm/78 3/4" Transparent Cable

ELECTRICAL

Lamp Type: LED
 Input Wattage (W): 6
 Dimming: Tri-Mode (Non-Dimming and Phase Dimming (120Vac only) and 0-10V Dimming)
 Driver Included: Yes
 Driver Location: Integrated
 Driver Type: Constant Current - Universal
 Driver Class: Class 2
 Input Voltage (V): 120
 Constant Current (MA): 500mA

LED

Number of LEDs: 1
 Color Temperature (°K): [2700 / 3000](#)
 Nominal Lumen (lm): 866
 CRI: >95 CRI
 Lamp Life (hrs): 50000

OPTICAL

RATINGS AND CERTIFICATIONS

Certified By: Certified for North American Standards
 IP rating: IP20

| |
|-----------|
| PROJECT |
| TYPE |
| SPECIFIER |
| QUANTITY |
| DATE |

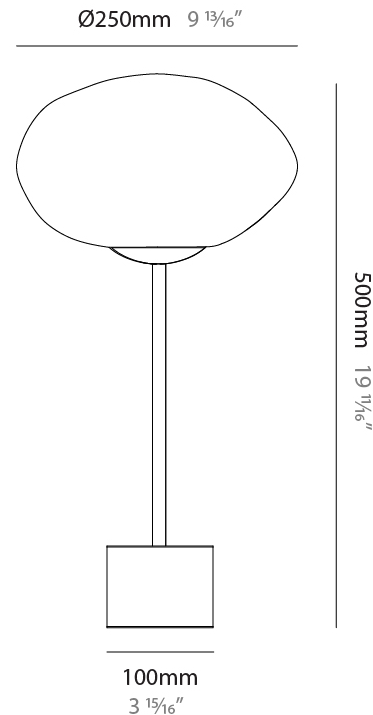

D144050-

| | |
|-----------|-------|
| PROJECT | _____ |
| TYPE | _____ |
| SPECIFIER | _____ |
| QUANTITY | _____ |
| DATE | _____ |

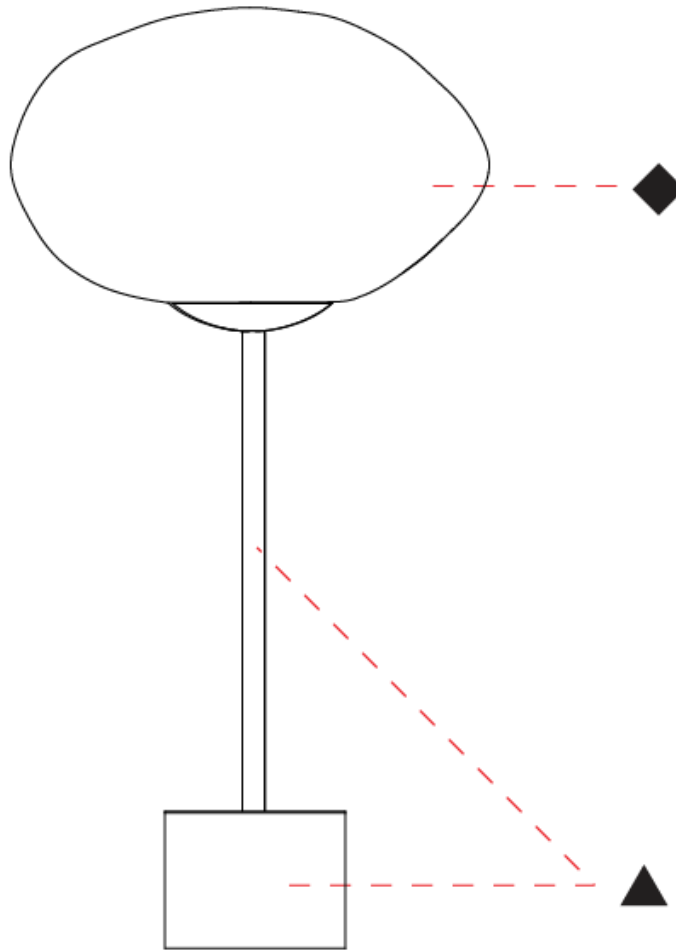

D

MARK PORTABLE

D144051-

base number Color Finish Finish
 Temperature Options Options

- To build a product code in our configurator select the specify button on the base model # product page
- To build a manual product code on this datasheet choose from the options listed below in blue font and add the suffix to the base model #

GENERAL

Series: Mark
 Partner: Cangini & Tucci
 Division: Design
 Installation: Portable
 Product Type: Table
 Mounting Location: Table

PHYSICAL

Shape: Oval
 Diameter (mm): 250
 Diameter (in): 9 ¹³/₁₆
 Height (mm): 500
 Height (in): 19 ¹¹/₁₆
 Weight (kg): 6.50
 Weight (lbs): 14.33
 Fixture Finish: [AMB / BLK / BRZ / GLD / GRN / PNK / RGD / RUB / SKB / SMK / STE / TOB / TRA](#)
 Holder Finish: [SGD / SBK](#)
 Fixture Material: [Glass / Metal](#)
 Primary Material: [Glass - Borosilicate](#)
 Cable Details: [2000mm/78 3/4" Transparent Cable](#)

ELECTRICAL

Lamp Type: LED
 Input Wattage (W): 6
 Dimming: [Tri-Mode \(Non-Dimming and Phase Dimming \(120Vac only\) and 0-10V Dimming\)](#)
 Driver Included: [Yes](#)
 Driver Location: [Integrated](#)
 Driver Type: [Constant Current - Universal](#)
 Driver Class: [Class 2](#)
 Input Voltage (V): [120](#)
 Constant Current (MA): [500mA](#)

LED

Number of LEDs: 1
 Color Temperature (°K): [2700 / 3000](#)
 Nominal Lumen (lm): [866](#)
 CRI: [>95 CRI](#)
 Lamp Life (hrs): [50000](#)

OPTICAL

RATINGS AND CERTIFICATIONS

Certified By: [Certified for North American Standards](#)
 IP rating: [IP20](#)

| |
|-----------|
| PROJECT |
| TYPE |
| SPECIFIER |
| QUANTITY |
| DATE |

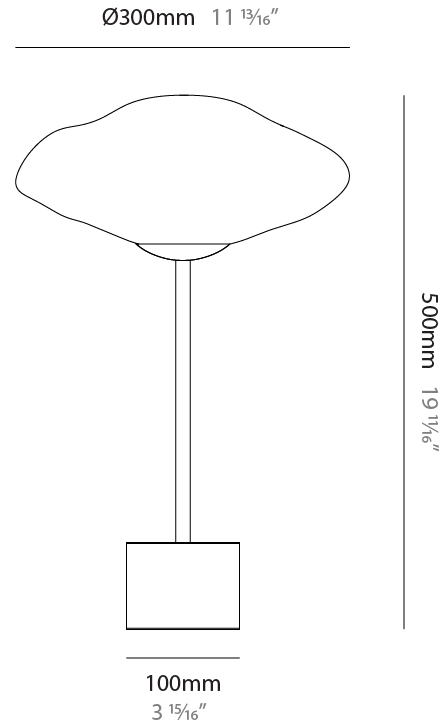

D144051-

| | |
|-----------|-------|
| PROJECT | _____ |
| TYPE | _____ |
| SPECIFIER | _____ |
| QUANTITY | _____ |
| DATE | _____ |

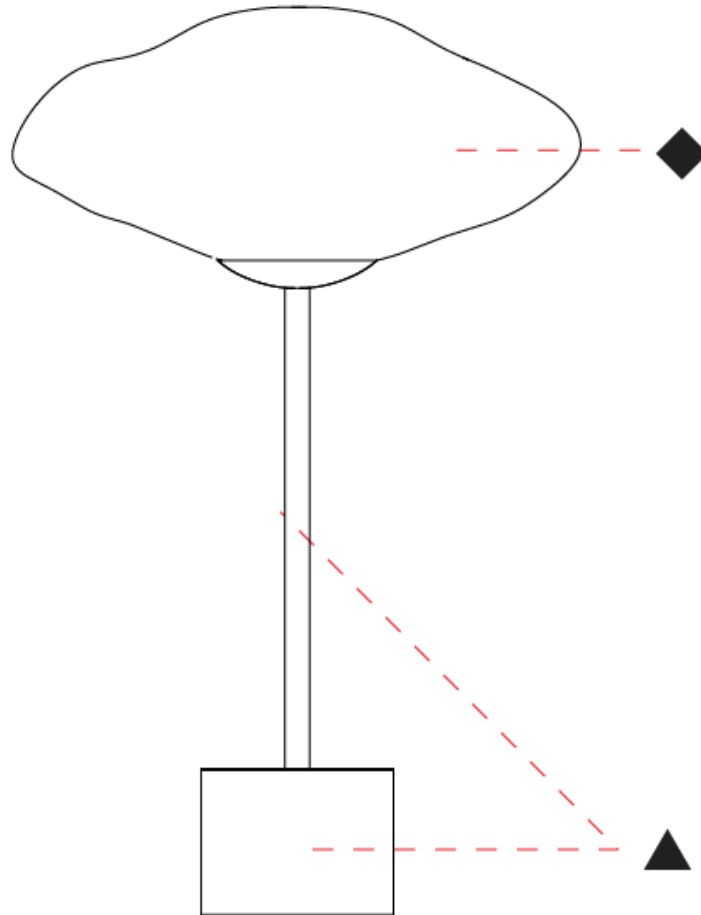

D

MARK PORTABLE

D144052-

base number Color Finish Finish
 Temperature Options Options

- To build a product code in our configurator select the specify button on the base model # product page
- To build a manual product code on this datasheet choose from the options listed below in blue font and add the suffix to the base model #

GENERAL

Series: Mark
 Partner: Cangini & Tucci
 Division: Design
 Installation: Portable
 Product Type: Floor
 Mounting Location: Floor

PHYSICAL

Shape: Round
 Diameter (mm): 300
 Diameter (in): 11 ¹³/₁₆
 Height (mm): 1820
 Height (in): 71 ⁵/₈
 Weight (kg): 8.0
 Weight (lbs): 17.64
 Fixture Finish: [AMB / BLK / BRZ / GLD / GRN / PNK / RGD / RUB / SKB / SMK / STE / TOB / TRA](#)
 Holder Finish: [SGD / SBK](#)
 Fixture Material: Glass / Metal
 Primary Material: Glass - Borosilicate
 Cable Details: 2000mm/78 3/4" Transparent Cable

ELECTRICAL

Lamp Type: LED
 Input Wattage (W): 12
 Dimming: Tri-Mode (Non-Dimming and Phase Dimming (120Vac only) and 0-10V Dimming)
 Driver Included: Yes
 Driver Location: Integrated
 Driver Type: Constant Current - Universal
 Driver Class: Class 2
 Input Voltage (V): 120
 Constant Current (MA): 500mA

LED

Number of LEDs: 1
 Color Temperature (°K): [2700 / 3000](#)
 Nominal Lumen (lm): 1717
 CRI: >95 CRI
 Lamp Life (hrs): 50000

OPTICAL

RATINGS AND CERTIFICATIONS

Certified By: Certified for North American Standards
 IP rating: IP20

| |
|-----------|
| PROJECT |
| TYPE |
| SPECIFIER |
| QUANTITY |
| DATE |

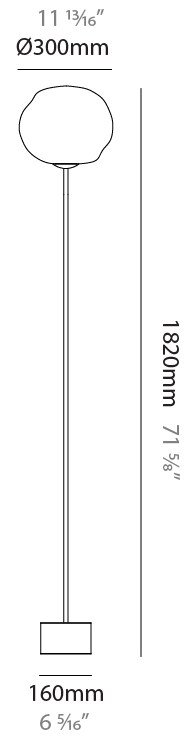

D144052-

| |
|-----------|
| PROJECT |
| TYPE |
| SPECIFIER |
| QUANTITY |
| DATE |

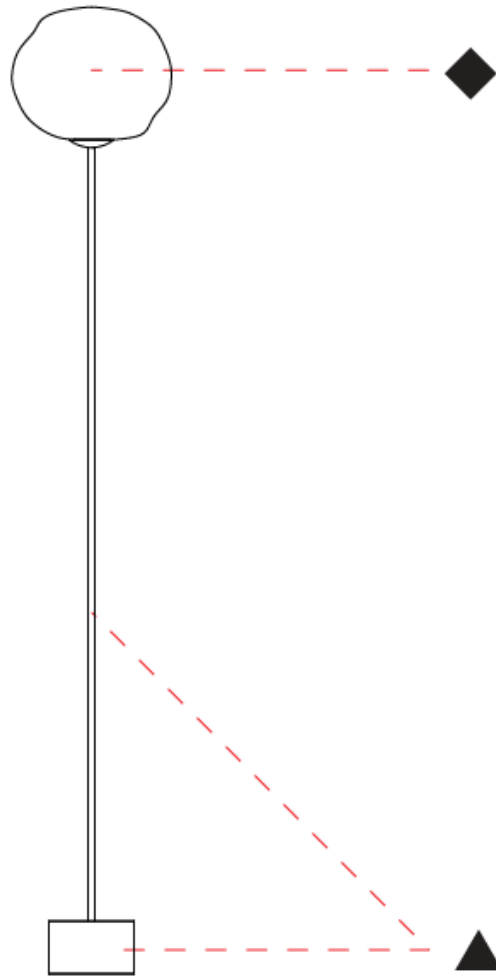

D

MARK PORTABLE

D144053-

base number Color Finish Finish
 Temperature Options Options

- To build a product code in our configurator select the specify button on the base model # product page
- To build a manual product code on this datasheet choose from the options listed below in blue font and add the suffix to the base model #

GENERAL

Series: Mark
 Partner: Cangini & Tucci
 Division: Design
 Installation: Portable
 Product Type: Floor
 Mounting Location: Floor

PHYSICAL

Shape: Oval
 Diameter (mm): 350
 Diameter (in): 13 ³/₄
 Height (mm): 1700
 Height (in): 66 ¹⁵/₁₆
 Weight (kg): 8.0
 Weight (lbs): 17.64
 Fixture Finish: [AMB / BLK / BRZ / GLD / GRN / PNK / RGD / RUB / SKB / SMK / STE / TOB / TRA](#)
 Holder Finish: [SGD / SBK](#)
 Fixture Material: Glass / Metal
 Primary Material: Glass - Borosilicate
 Cable Details: 2000mm/78 3/4" Transparent Cable

ELECTRICAL

Lamp Type: LED
 Input Wattage (W): 12
 Dimming: Tri-Mode (Non-Dimming and Phase Dimming (120Vac only) and 0-10V Dimming)
 Driver Included: Yes
 Driver Location: Integrated
 Driver Type: Constant Current - Universal
 Driver Class: Class 2
 Input Voltage (V): 120
 Constant Current (MA): 500mA

LED

Number of LEDs: 1
 Color Temperature (°K): [2700 / 3000](#)
 Nominal Lumen (lm): 1717
 CRI: >95 CRI
 Lamp Life (hrs): 50000

OPTICAL

RATINGS AND CERTIFICATIONS

Certified By: Certified for North American Standards
 IP rating: IP20

| |
|-----------|
| PROJECT |
| TYPE |
| SPECIFIER |
| QUANTITY |
| DATE |



11 ¹³/₁₆"
 Ø300mm

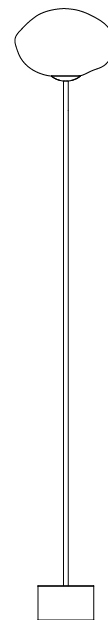

1800mm
 70 ⁷/₈"

160mm
 6 ⁵/₁₆"



D144053-

PROJECT

TYPE

SPECIFIER

QUANTITY

DATE

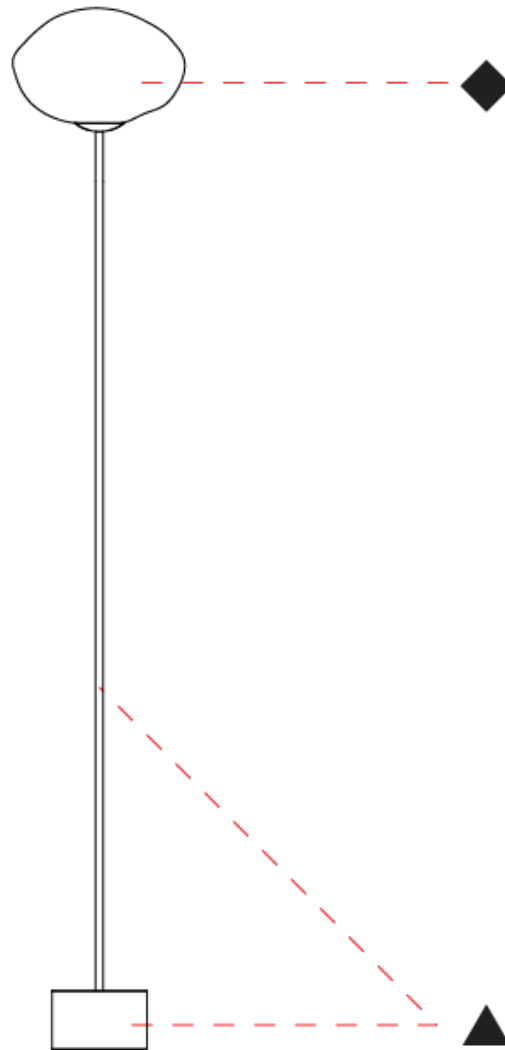

D

MARK PORTABLE

D144054-

base number Color Finish Finish
 Temperature Options Options

- To build a product code in our configurator select the specify button on the base model # product page
- To build a manual product code on this datasheet choose from the options listed below in blue font and add the suffix to the base model #

GENERAL

Series: Mark
 Partner: Cangini & Tucci
 Division: Design
 Installation: Portable
 Product Type: Floor
 Mounting Location: Floor

PHYSICAL

Shape: Oval
 Diameter (mm): 300
 Diameter (in): 11 ¹³/₁₆
 Height (mm): 1800
 Height (in): 70 ⁷/₈
 Weight (kg): 8.0
 Weight (lbs): 17.64
 Fixture Finish: AMB / BLK / BRZ / GLD / GRN / PNK / RGD / RUB / SKB / SMK / STE / TOB / TRA
 Holder Finish: SGD / SBK
 Fixture Material: Glass / Metal
 Primary Material: Glass - Borosilicate
 Cable Details: 2000mm/78 3/4" Transparent Cable

ELECTRICAL

Lamp Type: LED
 Input Wattage (W): 12
 Dimming: Tri-Mode (Non-Dimming and Phase Dimming (120Vac only) and 0-10V Dimming)
 Driver Included: Yes
 Driver Location: Integrated
 Driver Type: Constant Current - Universal
 Driver Class: Class 2
 Input Voltage (V): 120
 Constant Current (MA): 500mA

LED

Number of LEDs: 1
 Color Temperature (°K): 2700 / 3000
 Nominal Lumen (lm): 1717
 CRI: >95 CRI
 Lamp Life (hrs): 50000

OPTICAL

RATINGS AND CERTIFICATIONS

Certified By: Certified for North American Standards
 IP rating: IP20

| |
|-----------|
| PROJECT |
| TYPE |
| SPECIFIER |
| QUANTITY |
| DATE |



13 ³/₄"
 Ø350mm

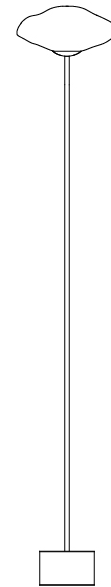

1700mm
 66 ⁵/₈"

160mm
 6 ⁵/₁₆"



D144054-

PROJECT

TYPE

SPECIFIER

QUANTITY

DATE

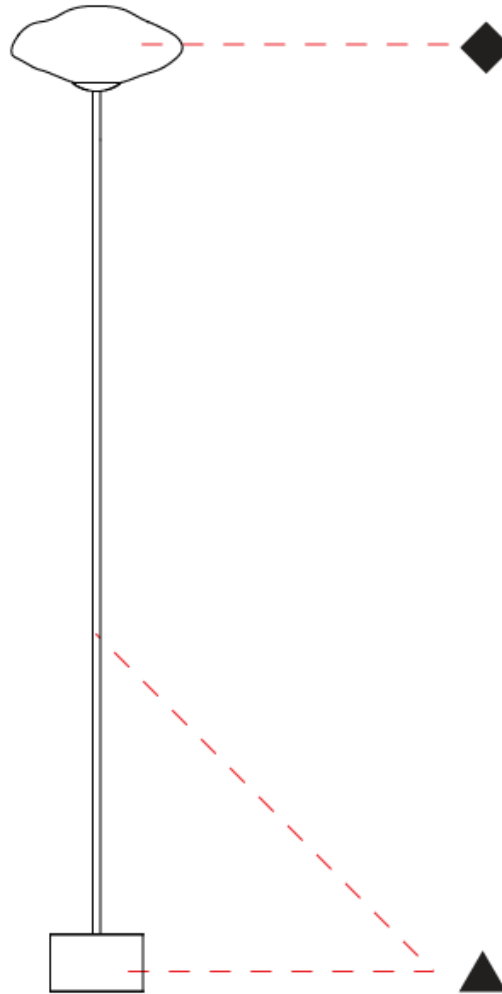

D

| | |
|-----------|-------|
| PROJECT | _____ |
| TYPE | _____ |
| SPECIFIER | _____ |
| QUANTITY | _____ |
| DATE | _____ |

MARK - MODULAR SYSTEM SUSPENSION

D14MARK-MOD-SYS

base number

1. To build a product code in our configurator select the specify button on the base model # product page
2. To build a manual product code on this datasheet choose from the options listed below in blue font and add the suffix to the base model #

GENERAL

Series: Mark _____
Subseries: Mark - Modular System _____
Partner: Cangini & Tucci _____
Division: Design _____
Installation: Suspension _____
Product Type: Clusters _____
Mounting Location: Ceiling _____

PHYSICAL

ELECTRICAL

Lamp Type: LED _____

LED

OPTICAL

RATINGS AND CERTIFICATIONS

Certified By: Certified for North American Standards _____
IP rating: IP20 _____



| | |
|-----------|--|
| PROJECT | |
| TYPE | |
| SPECIFIER | |
| QUANTITY | |
| DATE | |

Fixture Finish

Amber - AMB



Black - BLK



Bronze - BRZ

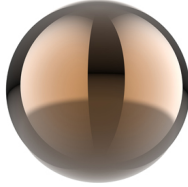

Gold - GLD

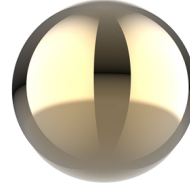

Green - GRN



Pink - PNK



Rose Gold - RGD



Ruby - RUB



Sky Blue - SKB



Smoke - SMK



Steel - STE



Tobacco - TOB



Transparent - TRA



Holder Finish

Chrome - CHR



Brushed Chrome - BCR

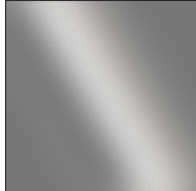

Matte White - MWH

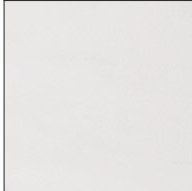

Matte Black - MBK

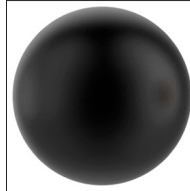

Satin Gold - SGD

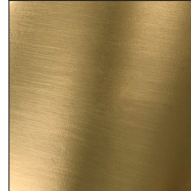





































































Satin Black Nickel - SBK













Digital: Not all screens are calibrated the same, and therefore, colors will appear differently between screens.

Physical: When texture is involved, there will be variations in color, character and tone within a product series and between product families.











LEGEND

| | | | | | |
|--|---|---|--|---|--|
|  | floor-mounted |  | pivotal |  | special LED (upon request) RGB, RGBW, tunable, gold+, meat+, art+, fashion+ |
|  | wall and ceiling: recessed and surface mounted |  | rotating |  | warm dim / natural dimming LED |
|  | ceiling-mounted and wall-mounted |  | illuminate tilted |  | rechargeable battery powered |
|  | wall-mounted |  | color of suspension cable |  | fixture with natural vivid LED (upon request) |
|  | omni-directional light distribution |  | length of suspension cable |  | color rendering index |
|  | direct light distribution |  | reflector degree selection |  | color temperature |
|  | direct/indirect light distribution |  | super spot |  | lumen (luminous flux) |
|  | indirect light distribution |  | lens |  | efficacy (lumens per watt) |
|  | asymmetric light distribution |  | lens pack |  | Unified Glare Rating (UGR) range from 5-40 |
|  | aura light distribution |  | shine ring |  | marine grade (AISI 316 stainless steel) |
|  | round wall or ceiling cut-out |  | integrated shine ring with diffuser |  | walk on |
|  | square wall or ceiling cut-out |  | free individual colors 01-29 |  | drive on |
|  | the supplied jig specifies the cutout dimensions |  | individual colors: 00 (free of charge), 01-25 (extra charge) |  | Dark Sky Compliance |
|  | minimum distance (meters) lamp - object |  | luminaire part to be colored (F1) |  | Americans with Disabilities Act (less than 4" off the wall located between 27"-84" from floor) |
|  | recessed depth |  | luminaire part to be colored (F2) |  | lamp protected against explosion |
|  | ceiling thickness in mm |  | luminaire part to be colored (F3) |  | blown glass using traditional methods by master glass blower |
|  | ceiling thickness selection |  | luminaire part to be colored (F4) |  | acoustic material |
|  | dimmable DP (phase), DV (0-10V), DD (dali), DS (step-dim) |  | luminaire part to be colored (F5) |  | protection class I, protection insulation |
|  | included or excluded LED driver/transformer/control gear |  | color of 3-circuit adaptor |  | protection class II, protection insulation |
|  | separately switchable |  | indirect diffuser |  | ETL Certified to UL and CSA Standards |
|  | sensor |  | direct diffuser |  | UL Certified to UL and CSA Standards |
|  | remote control |  | ball-proof (upon request) |  | CSA Certified to UL and CSA Standards |
|  | available upon request |  | accessory |  | Certified for North American Standards |

IP RATING

| | |
|---|--|
|  | protected against ingress of solid bodies greater than 12.5mm (finger) |
|  | protected against ingress of solid bodies greater than 2.5mm protected against sprays of water up to 60 degrees from the vertical (rain) |
|  | protected against ingress of solid bodies greater than 1mm (wire) no protection against the ingress of moisture |
|  | protected against ingress of solid bodies greater than 1mm (wire) protected against sprays of water up to 60 degrees from the vertical (rain) |
|  | protected against ingress of solid bodies greater than 1mm (wire) protected against water splashed from all directions |
|  | protected against limited ingress of dust (wet rooms/covered outdoor areas) protected against water splashed from all directions |
|  | protected against ingress of dust protected against jets of water |
|  | protected against ingress of dust protected against powerful jets of water or heavy seas |
|  | protected against ingress of dust protected against immersion of water between 15cm - 1m for 30 minutes |
|  | protected against ingress of dust protected against immersion of water under pressure for long periods |

IK RATING

| | |
|---|---|
|  | protected against 0.14 joules impact (equivalent to 0.25kg mass dropped from 56mm above the surface) |
|  | protected against 0.2 joules impact (equivalent to 0.25kg mass dropped from 80mm above the surface) |
|  | protected against 0.35 joules impact (equivalent to 0.25kg mass dropped from 140mm above the surface) |
|  | protected against 0.5 joules impact (equivalent to 0.25kg mass dropped from 200mm above the surface) |
|  | protected against 0.7 joules impact (equivalent to 0.25kg mass dropped from 280mm above the surface) |
|  | protected against 1 joules impact (equivalent to 0.25kg mass dropped from 400mm above the surface) |
|  | protected against 2 joules impact (equivalent to 0.5kg mass dropped from 400mm above the surface) |
|  | protected against 5 joules impact (equivalent to 1.7kg mass dropped from 300mm above the surface) |
|  | protected against 10 joules impact (equivalent to 5.0kg mass dropped from 200mm above the surface) |
|  | protected against 20 joules impact (equivalent to 5.0kg mass dropped from 400mm above the surface) |