

PROJECT
TYPE
SPECIFIER
QUANTITY
DATE

MARK - MONOPOINT SUSPENSION

D141313-

base number Color Finish Finish
 Temperature Options Options

- To build a product code in our configurator select the specify button on the base model # product page
- To build a manual product code on this datasheet choose from the options listed below in blue font and add the suffix to the base model #

GENERAL

Series: Mark
 Subseries: Mark - Monopoint
 Partner: Cangini & Tucci
 Division: Design
 Installation: Suspension
 Product Type: Pendant
 Mounting Location: Ceiling

PHYSICAL

Shape: Round
 Diameter (mm): 300
 Diameter (in): 11 ¹³/₁₆
 Height (mm): 300
 Height (in): 12 ³/₁₆
 Max. Overall Height (mm): 2300
 Max. Overall Height (in): 90 ⁹/₁₆
 Weight (kg): 1.50
 Weight (lbs): 3.31
 Diffuser: Glass
 Fixture Finish: [AMB](#) / [BLK](#) / [BRZ](#) / [GLD](#) / [GRN](#) / [PNK](#) / [RGD](#) / [RUB](#) / [SKB](#) / [SMK](#) / [STE](#) / [TOB](#) / [TRA](#)
 Holder Finish: [CHR](#) / [BCR](#) / [MWH](#) / [MBK](#)
 Fixture Material: Glass / Metal
 Primary Material: Glass - Borosilicate
 Cable Details: 2000mm/78 3/4" Transparent Cable

ELECTRICAL

Lamp Type: LED
 Input Wattage (W): 8.4
 Dimming: Tri-Mode (Non-Dimming and Phase Dimming (120Vac only) and 0-10V Dimming)
 Driver Included: Yes
 Driver Location: Integrated
 Driver Type: Constant Current - Universal
 Driver Class: Class 2
 Input Voltage (V): 120
 Constant Current (MA): 350mA

LED

Number of LEDs: 1
 Color Temperature (°K): [2700](#) / [3000](#)
 Nominal Lumen (lm): 1202
 CRI: >95 CRI
 Efficacy (lm/w): 144
 Lamp Life (hrs): 50000

OPTICAL

RATINGS AND CERTIFICATIONS

Certified By: Certified for North American Standards
 IP rating: IP20

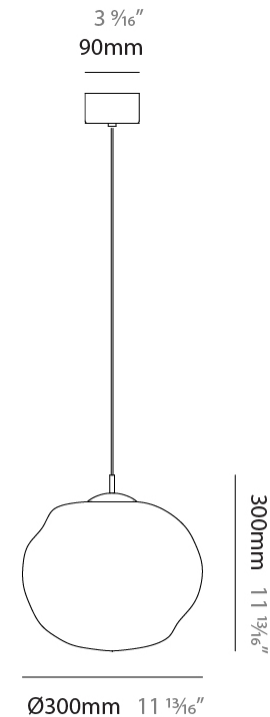

MARK - MONOPOINT SUSPENSION

D141313-

PROJECT
TYPE
SPECIFIER
QUANTITY
DATE

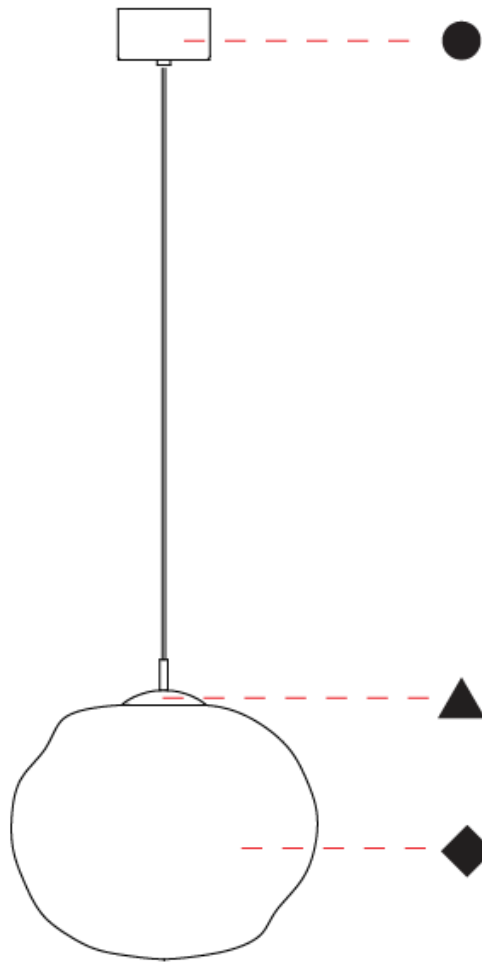

D

MARK - MONOPOINT SUSPENSION

D141315-

base number Color Finish Finish
 Temperature Options Options

- To build a product code in our configurator select the specify button on the base model # product page
- To build a manual product code on this datasheet choose from the options listed below in blue font and add the suffix to the base model #

GENERAL

Series: Mark
 Subseries: Mark - Monopoint
 Partner: Cangini & Tucci
 Division: Design
 Installation: Suspension
 Product Type: Pendant
 Mounting Location: Ceiling

PHYSICAL

Shape: Oval
 Diameter (mm): 300
 Diameter (in): 11 ¹³/₁₆
 Height (mm): 240
 Height (in): 9 ⁷/₁₆
 Max. Overall Height (mm): 2240
 Max. Overall Height (in): 88 ³/₁₆
 Weight (kg): 1.50
 Weight (lbs): 3.31
 Diffuser: Glass
 Fixture Finish: [AMB / BLK / BRZ / GLD / GRN / PNK / RGD / RUB / SKB / SMK / STE / TOB / TRA](#)
 Holder Finish: CHR / BCR / MWH / MBK
 Fixture Material: Glass / Metal
 Primary Material: Glass - Borosilicate
 Cable Details: 2000mm/78 3/4" Transparent Cable

ELECTRICAL

Lamp Type: LED
 Input Wattage (W): 8.4
 Dimming: Tri-Mode (Non-Dimming and Phase Dimming (120Vac only) and 0-10V Dimming)
 Driver Included: Yes
 Driver Location: Integrated
 Driver Type: Constant Current - Universal
 Driver Class: Class 2
 Input Voltage (V): 120
 Constant Current (MA): 350mA

LED

Number of LEDs: 1
 Color Temperature (°K): [2700 / 3000](#)
 Nominal Lumen (lm): 1202
 CRI: >95 CRI
 Efficacy (lm/w): 144
 Lamp Life (hrs): 50000

OPTICAL

RATINGS AND CERTIFICATIONS

Certified By: Certified for North American Standards
 IP rating: IP20

PROJECT
TYPE
SPECIFIER
QUANTITY
DATE

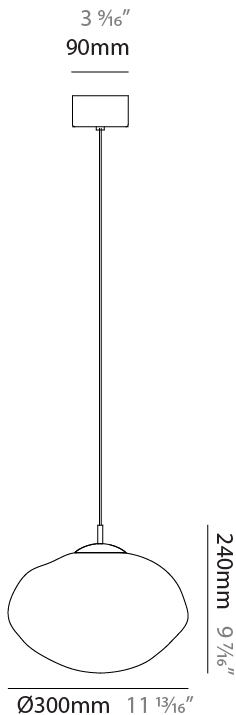

MARK - MONOPOINT SUSPENSION

D141315-

PROJECT
TYPE
SPECIFIER
QUANTITY
DATE

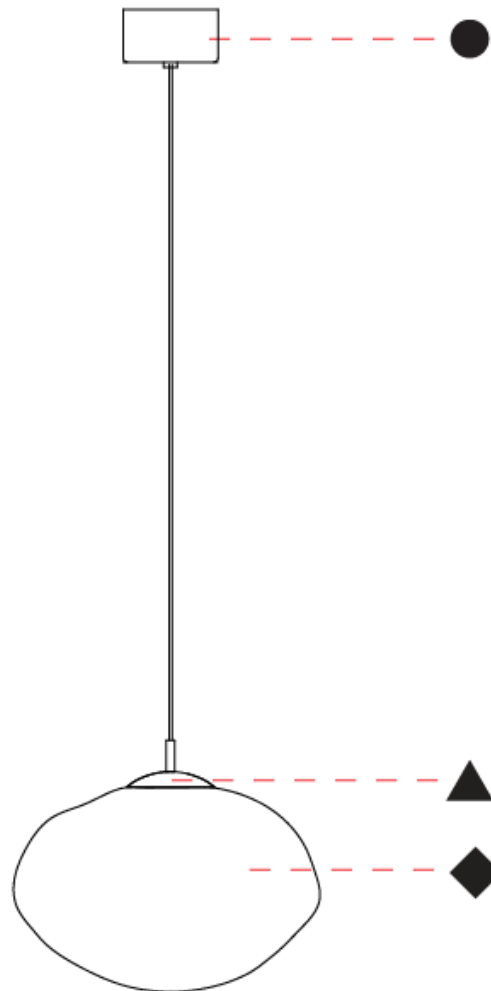

D

MARK - MONOPOINT SUSPENSION

D141317-

base number Color Finish Finish
Temperature Options Options

- To build a product code in our configurator select the specify button on the base model # product page
- To build a manual product code on this datasheet choose from the options listed below in blue font and add the suffix to the base model #

GENERAL

Series: Mark
Subseries: Mark - Monopoint
Partner: Cangini & Tucci
Division: Design
Installation: Suspension
Product Type: Pendant
Mounting Location: Ceiling

PHYSICAL

Shape: Oval
Diameter (mm): 350
Diameter (in): 13 ³/₄
Height (mm): 200
Height (in): 8 ¹¹/₁₆
Max. Overall Height (mm): 2200
Max. Overall Height (in): 86 ⁵/₈
Weight (kg): 1.50
Weight (lbs): 3.31
Diffuser: Glass
Fixture Finish: [AMB](#) / [BLK](#) / [BRZ](#) / [GLD](#) / [GRN](#) / [PNK](#) / [RGD](#) / [RUB](#) / [SKB](#) / [SMK](#) / [STE](#) / [TOB](#) / [TRA](#)
Holder Finish: [CHR](#) / [BCR](#) / [MWH](#) / [MBK](#)
Fixture Material: Glass / Metal
Primary Material: Glass - Borosilicate

ELECTRICAL

Lamp Type: LED
Input Wattage (W): 8.4
Dimming: Tri-Mode (Non-Dimming and Phase Dimming (120Vac only) and 0-10V Dimming)
Driver Included: Yes
Driver Location: Integrated
Driver Type: Constant Current - Universal
Driver Class: Class 2
Input Voltage (V): 120
Constant Current (MA): 350mA

LED

Number of LEDs: 1
Color Temperature (°K): [2700](#) / [3000](#)
Nominal Lumen (lm): 1202
CRI: >95 CRI
Efficacy (lm/w): 144
Lamp Life (hrs): 50000

OPTICAL

RATINGS AND CERTIFICATIONS

Certified By: Certified for North American Standards
IP rating: IP20

PROJECT
TYPE
SPECIFIER
QUANTITY
DATE

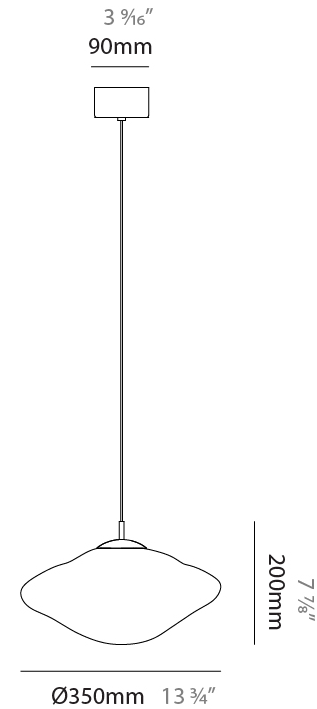

MARK - MONOPOINT SUSPENSION

D141317-

PROJECT	_____
TYPE	_____
SPECIFIER	_____
QUANTITY	_____
DATE	_____

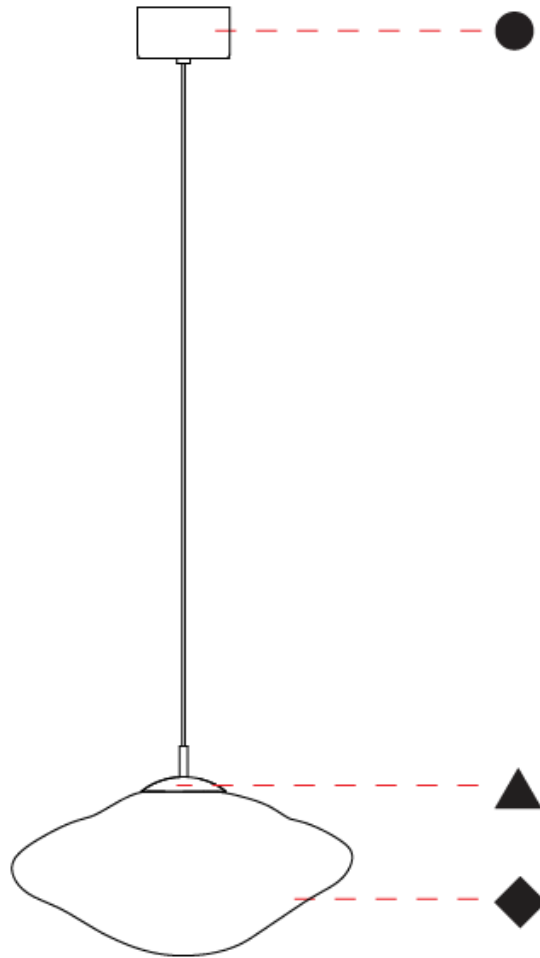

D

PROJECT
TYPE
SPECIFIER
QUANTITY
DATE

MARK - MONOPOINT SUSPENSION

D141317- : D141317-30K-MBK-TRA

base number Color Finish Finish
Temperature Options Options

- To build a product code in our configurator select the specify button on the base model # product page
- To build a manual product code on this datasheet choose from the options listed below in blue font and add the suffix to the base model #

GENERAL

Series: Mark
 Subseries: Mark - Monopoint
 Partner: Cangini & Tucci
 Division: Design
 Installation: Suspension
 Product Type: Pendant
 Mounting Location: Ceiling

PHYSICAL

Shape: Oval
 Diameter (mm): 350
 Diameter (in): 13 ³/₄
 Height (mm): 200
 Height (in): 8 ¹¹/₁₆
 Max. Overall Height (mm): 2200
 Max. Overall Height (in): 86 ⁵/₈
 Weight (kg): 1.50
 Weight (lbs): 3.31
 Diffuser: Glass
 Fixture Finish: [AMB](#) / [BLK](#) / [BRZ](#) / [GLD](#) / [GRN](#) / [PNK](#) / [RGD](#) / [RUB](#) / [SKB](#) / [SMK](#) / [STE](#) / [TOB](#) / [TRA](#)
 Holder Finish: [CHR](#) / [BCR](#) / [MWH](#) / [MBK](#)
 Fixture Material: Glass / Metal
 Primary Material: Glass - Borosilicate

ELECTRICAL

Lamp Type: LED
 Input Wattage (W): 8.4
 Dimming: Tri-Mode (Non-Dimming and Phase Dimming (120Vac only) and 0-10V Dimming)
 Driver Included: Yes
 Driver Location: Integrated
 Driver Type: Constant Current - Universal
 Driver Class: Class 2
 Input Voltage (V): 120
 Constant Current (MA): 350mA

LED

Number of LEDs: 1
 Color Temperature (°K): [2700](#) / [3000](#)
 Nominal Lumen (lm): 1202
 CRI: >95 CRI
 Efficacy (lm/w): 144
 Lamp Life (hrs): 50000

OPTICAL

RATINGS AND CERTIFICATIONS

Certified By: Certified for North American Standards
 IP rating: IP20

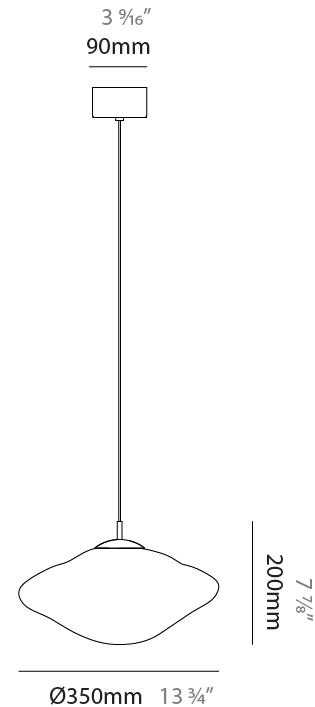

MARK - MONOPOINT SUSPENSION

D141317- : D141317-30K-MBK-TRA

PROJECT	_____
TYPE	_____
SPECIFIER	_____
QUANTITY	_____
DATE	_____

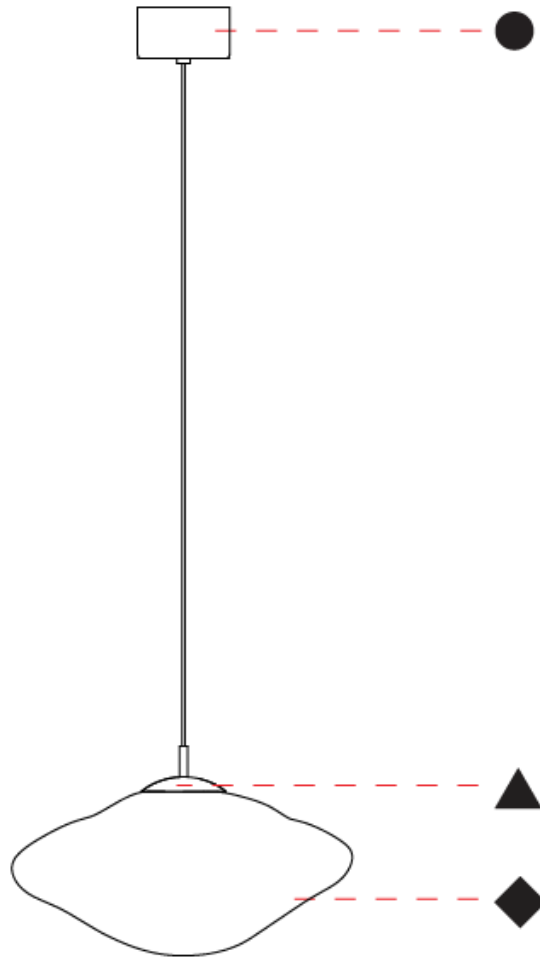

D

MARK - 3L LINEAR SUSPENSION

D141324-

base number Color Finish Finish
 Temperature Options Options

- To build a product code in our configurator select the specify button on the base model # product page
- To build a manual product code on this datasheet choose from the options listed below in blue font and add the suffix to the base model #

GENERAL

Series: Mark
 Subseries: Mark - 3L Linear
 Partner: Cangini & Tucci
 Division: Design
 Installation: Suspension
 Product Type: Clusters
 Mounting Location: Ceiling

PHYSICAL

Diameter (mm): 300
 Diameter (in): 11 ¹³/₁₆
 Length (mm): 1200
 Length (in): 47 ¹/₄
 Height (mm): 300
 Height (in): 11 ¹³/₁₆
 Max. Overall Height (mm): 2300
 Max. Overall Height (in): 90 ⁹/₁₆
 Weight (kg): 1.50
 Weight (lbs): 3.31
 Diffuser: Glass
 Fixture Finish: [AMB / BLK / BRZ / GLD / GRN / PNK / RGD / RUB / SKB / SMK / STE / TOB / TRA](#)
 Holder Finish: [CHR / BCR / MWH / MBK](#)
 Fixture Material: Glass / Metal
 Primary Material: Glass - Borosilicate

ELECTRICAL

Lamp Type: LED
 Input Wattage (W): 25.2
 Dimming: Tri-Mode (Non-Dimming and Phase Dimming (120Vac only) and 0-10V Dimming)
 Driver Included: Yes
 Driver Location: Integrated
 Driver Type: Constant Current - Universal
 Driver Class: Class 2
 Input Voltage (V): 120
 Constant Current (MA): 350mA

LED

Number of LEDs: 3
 Color Temperature (°K): [2700 / 3000](#)
 Nominal Lumen (lm): 3606
 CRI: >95 CRI
 Lamp Life (hrs): 50000

OPTICAL

RATINGS AND CERTIFICATIONS

Certified By: Certified for North American Standards
 IP rating: IP20

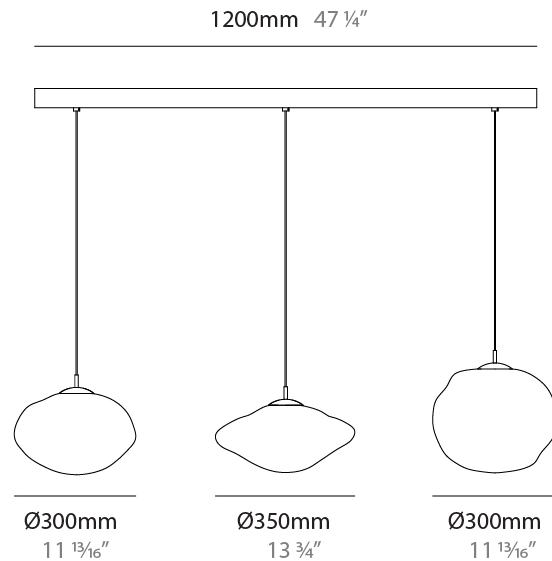

MARK - 3L LINEAR SUSPENSION

D141324-

PROJECT	_____
TYPE	_____
SPECIFIER	_____
QUANTITY	_____
DATE	_____

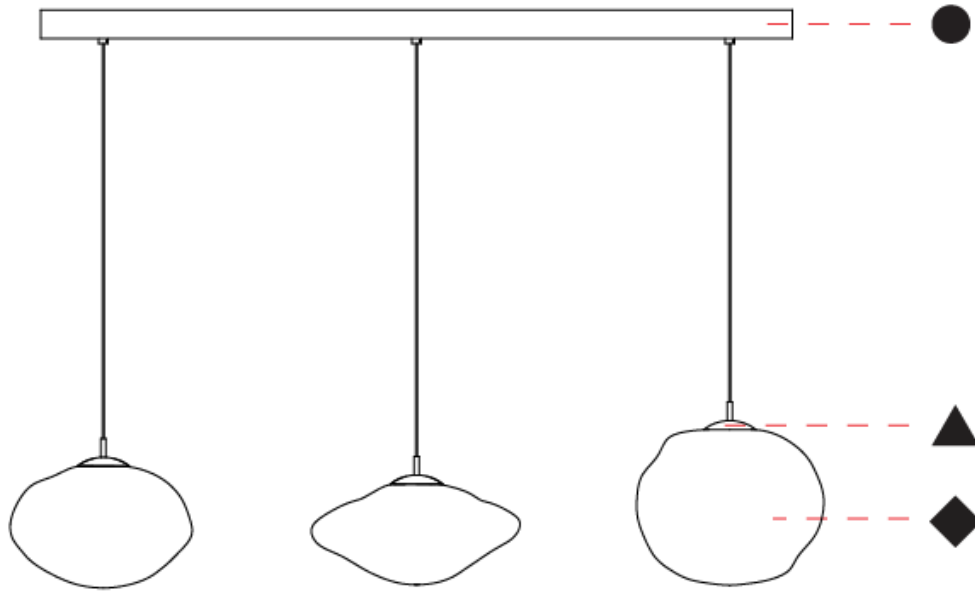

D

PROJECT
TYPE
SPECIFIER
QUANTITY
DATE

MARK SURFACE

D142024-

base number Color Temperature Finish Options Finish Options

- To build a product code in our configurator select the specify button on the base model # product page
- To build a manual product code on this datasheet choose from the options listed below in blue font and add the suffix to the base model #

GENERAL

Series: Mark
 Partner: Cangini & Tucci
 Division: Design
 Installation: Surface
 Product Type: Ceiling Surface
 Mounting Location: Ceiling

PHYSICAL

Shape: Round
 Diameter (mm): 300
 Diameter (in): 11 ¹³/₁₆
 Height (mm): 310
 Height (in): 12 ³/₁₆
 Weight (kg): 1.50
 Weight (lbs): 3.31
 Diffuser: Glass
 Fixture Finish: [AMB](#) / [BLK](#) / [BRZ](#) / [GLD](#) / [GRN](#) / [PNK](#) / [RGD](#) / [RUB](#) / [SKB](#) / [SMK](#) / [STE](#) / [TOB](#) / [TRA](#)
 Holder Finish: [CHR](#) / [BCR](#) / [MWH](#) / [MBK](#)
 Fixture Material: Glass / Metal
 Primary Material: Glass - Borosilicate

ELECTRICAL

Lamp Type: LED
 Input Wattage (W): 8.4
 Dimming: Tri-Mode (Non-Dimming and Phase Dimming (120Vac only) and 0-10V Dimming)
 Driver Included: Yes
 Driver Location: Integrated
 Driver Type: Constant Current - Universal
 Driver Class: Class 2
 Input Voltage (V): 120
 Constant Current (MA): 350mA

LED

Number of LEDs: 1
 Color Temperature (°K): [2700](#) / [3000](#)
 Nominal Lumen (lm): 1202
 CRI: >95 CRI
 Efficacy (lm/w): 144
 Lamp Life (hrs): 50000

OPTICAL

RATINGS AND CERTIFICATIONS

Certified By: Certified for North American Standards
 IP rating: IP20

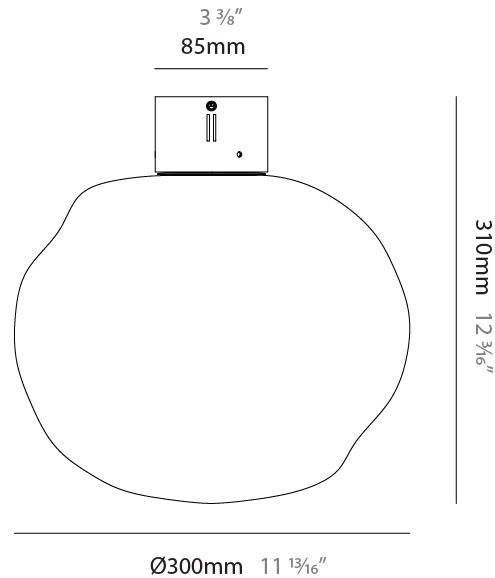

MARK SURFACE

D142024-

PROJECT _____

TYPE _____

SPECIFIER _____

QUANTITY _____

DATE _____

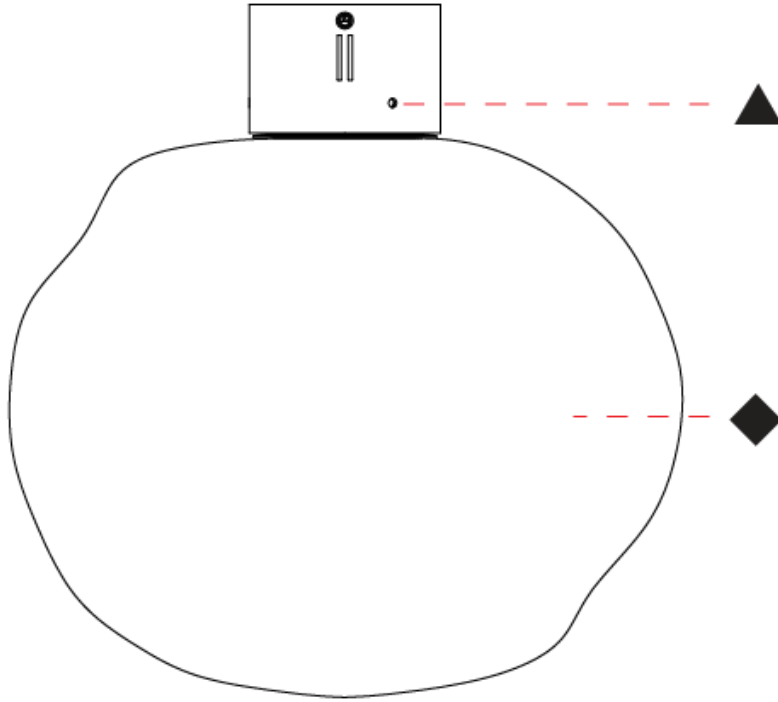

D

MARK SURFACE

D142026-

base number Color Finish Finish
 Temperature Options Options

- To build a product code in our configurator select the specify button on the base model # product page
- To build a manual product code on this datasheet choose from the options listed below in blue font and add the suffix to the base model #

GENERAL

Series: Mark
 Partner: Cangini & Tucci
 Division: Design
 Installation: Surface
 Product Type: Ceiling Surface
 Mounting Location: Ceiling

PHYSICAL

Shape: Oval
 Diameter (mm): 300
 Diameter (in): 11 ¹³/₁₆
 Height (mm): 260
 Height (in): 10 ¹/₄
 Weight (kg): 1.50
 Weight (lbs): 3.31
 Diffuser: Glass
 Fixture Finish: [AMB / BLK / BRZ / GLD / GRN / PNK / RGD / RUB / SKB / SMK / STE / TOB / TRA](#)
 Holder Finish: CHR / BCR / MWH / MBK
 Fixture Material: Glass / Metal
 Primary Material: Glass - Borosilicate

ELECTRICAL

Lamp Type: LED
 Input Wattage (W): 8.4
 Dimming: Tri-Mode (Non-Dimming and Phase Dimming (120Vac only) and 0-10V Dimming)
 Driver Included: Yes
 Driver Location: Integrated
 Driver Type: Constant Current - Universal
 Driver Class: Class 2
 Input Voltage (V): 120
 Constant Current (MA): 350mA

LED

Number of LEDs: 1
 Color Temperature (°K): [2700 / 3000](#)
 Nominal Lumen (lm): 1202
 CRI: >95 CRI
 Efficacy (lm/w): 144
 Lamp Life (hrs): 50000

OPTICAL

RATINGS AND CERTIFICATIONS

Certified By: Certified for North American Standards
 IP rating: IP20

PROJECT
TYPE
SPECIFIER
QUANTITY
DATE

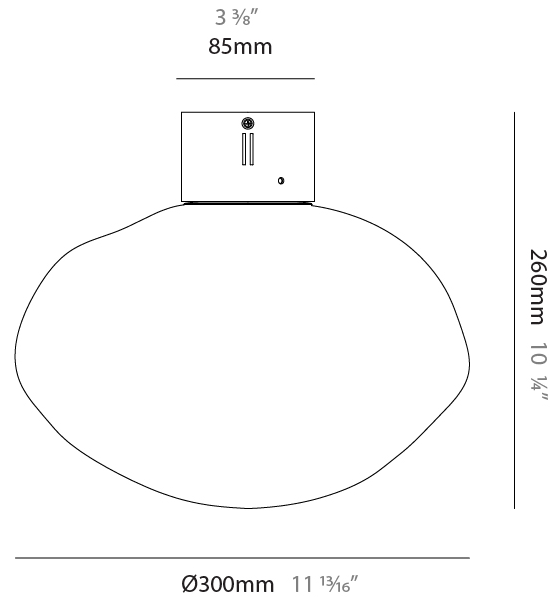

MARK SURFACE

D142026-

PROJECT	_____
TYPE	_____
SPECIFIER	_____
QUANTITY	_____
DATE	_____

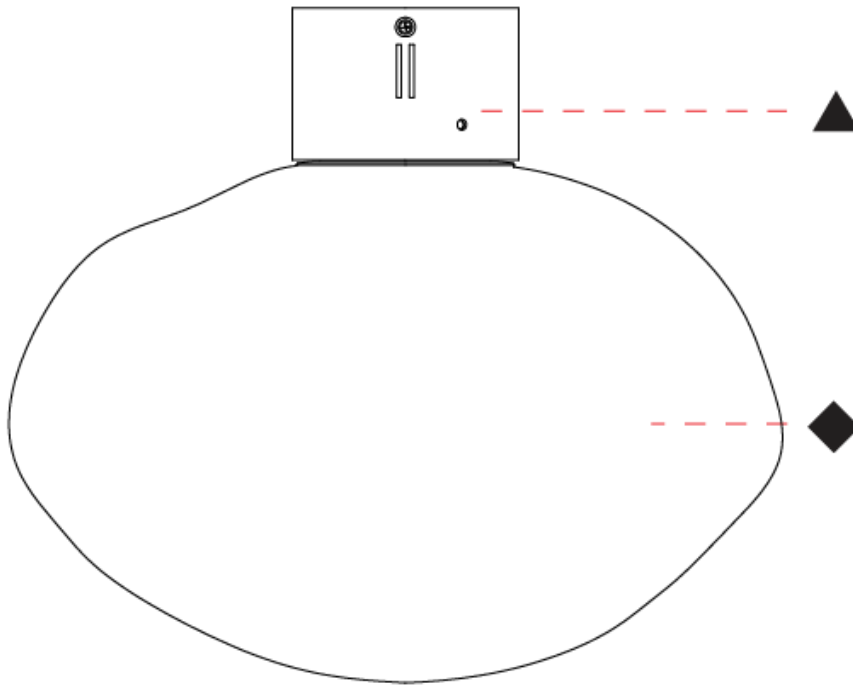

D

PROJECT
TYPE
SPECIFIER
QUANTITY
DATE

MARK SURFACE

D142028-

base number	Color Temperature	Finish Options	Finish Options
-------------	----------------------	-------------------	-------------------

- To build a product code in our configurator select the specify button on the base model # product page
- To build a manual product code on this datasheet choose from the options listed below in blue font and add the suffix to the base model #

GENERAL

Series: Mark
Partner: Cangini & Tucci
Division: Design
Installation: Surface
Product Type: Ceiling Surface
Mounting Location: Ceiling

PHYSICAL

Shape: Oval
Diameter (mm): 350
Diameter (in): 13 3/4
Height (mm): 220
Height (in): 8 11/16
Weight (kg): 1.50
Weight (lbs): 3.31
Diffuser: Glass
Fixture Finish: AMB / BLK / BRZ / GLD / GRN / PNK / RGD / RUB / SKB / SMK / STE / TOB / TRA
Holder Finish: CHR / BCR / MWH / MBK
Fixture Material: Glass / Metal
Primary Material: Glass - Borosilicate

ELECTRICAL

Lamp Type: LED
Input Wattage (W): 8.4
Dimming: Tri-Mode (Non-Dimming and Phase Dimming (120Vac only) and 0-10V Dimming)
Driver Included: Yes
Driver Location: Integrated
Driver Type: Constant Current - Universal
Driver Class: Class 2
Input Voltage (V): 120
Constant Current (MA): 350mA

LED

Number of LEDs: 1
Color Temperature (°K): 2700 / 3000
Nominal Lumen (lm): 1202
CRI: >95 CRI
Efficacy (lm/w): 144
Lamp Life (hrs): 50000

OPTICAL

RATINGS AND CERTIFICATIONS

Certified By: Certified for North American Standards
IP rating: IP20

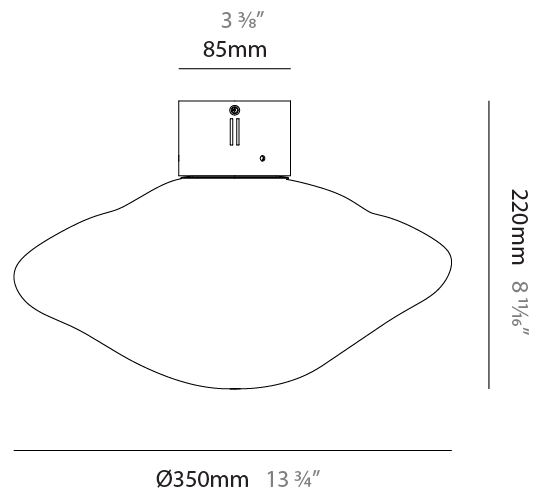

MARK SURFACE

D142028-

PROJECT

TYPE

SPECIFIER

QUANTITY

DATE

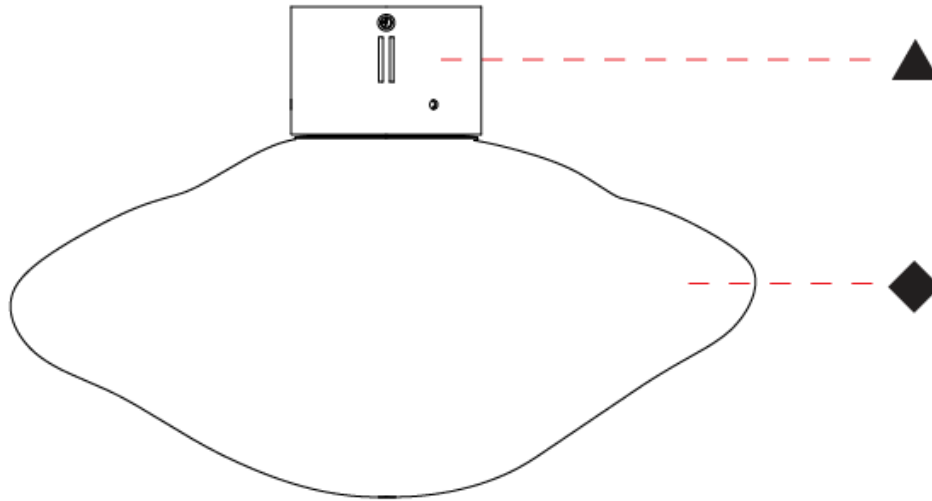

D

MARK

COLOR FINISH CHART

PROJECT _____

TYPE _____

SPECIFIER _____

QUANTITY _____

DATE _____

Fixture Finish

Amber - AMB



Black - BLK



Bronze - BRZ

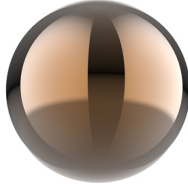

Gold - GLD

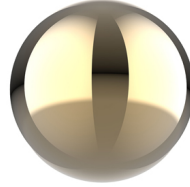

Green - GRN



Pink - PNK



Rose Gold - RGD

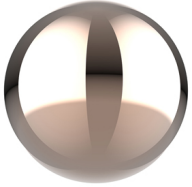

Ruby - RUB



Sky Blue - SKB



Smoke - SMK



Steel - STE



Tobacco - TOB



Transparent - TRA



Holder Finish

Chrome - CHR



Brushed Chrome - BCR



Matte White - MWH

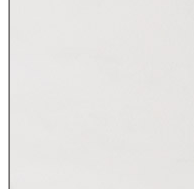

Matte Black - MBK

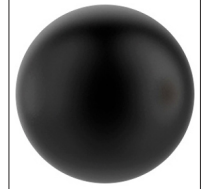





































































Digital: Not all screens are calibrated the same, and therefore, colors will appear differently between screens.











Physical: When texture is involved, there will be variations in color, character and tone within a product series and between product families.



LEGEND

	floor-mounted		pivotal		special LED (upon request) RGB, RGBW, tunable, gold+, meat+, art+, fashion+
	wall and ceiling: recessed and surface mounted		rotating		warm dim / natural dimming LED
	ceiling-mounted and wall-mounted		illuminate tilted		rechargeable battery powered
	wall-mounted		color of suspension cable		fixture with natural vivid LED (upon request)
	omni-directional light distribution		length of suspension cable		color rendering index
	direct light distribution		reflector degree selection		color temperature
	direct/indirect light distribution		super spot		lumen (luminous flux)
	indirect light distribution		lens		efficacy (lumens per watt)
	asymmetric light distribution		lens pack		Unified Glare Rating (UGR) range from 5-40
	aura light distribution		shine ring		marine grade (AISI 316 stainless steel)
	round wall or ceiling cut-out		integrated shine ring with diffuser		walk on
	square wall or ceiling cut-out		free individual colors 01-29		drive on
	the supplied jig specifies the cutout dimensions		individual colors: 00 (free of charge), 01-25 (extra charge)		Dark Sky Compliance
	minimum distance (meters) lamp - object		luminaire part to be colored (F1)		Americans with Disabilities Act (less than 4" off the wall located between 27"-84" from floor)
	recessed depth		luminaire part to be colored (F2)		lamp protected against explosion
	ceiling thickness in mm		luminaire part to be colored (F3)		blown glass using traditional methods by master glass blower
	ceiling thickness selection		luminaire part to be colored (F4)		acoustic material
	dimmable DP (phase), DV (0-10V), DD (dali), DS (step-dim)		luminaire part to be colored (F5)		protection class I, protection insulation
	included or excluded LED driver/transformer/control gear		color of 3-circuit adaptor		protection class II, protection insulation
	separately switchable		indirect diffuser		ETL Certified to UL and CSA Standards
	sensor		direct diffuser		UL Certified to UL and CSA Standards
	remote control		ball-proof (upon request)		CSA Certified to UL and CSA Standards
	available upon request		accessory		Certified for North American Standards

IP RATING

	protected against ingress of solid bodies greater than 12.5mm (finger)
	protected against ingress of solid bodies greater than 2.5mm protected against sprays of water up to 60 degrees from the vertical (rain)
	protected against ingress of solid bodies greater than 1mm (wire) no protection against the ingress of moisture
	protected against ingress of solid bodies greater than 1mm (wire) protected against sprays of water up to 60 degrees from the vertical (rain)
	protected against ingress of solid bodies greater than 1mm (wire) protected against water splashed from all directions
	protected against limited ingress of dust (wet rooms/covered outdoor areas) protected against water splashed from all directions
	protected against ingress of dust protected against jets of water
	protected against ingress of dust protected against powerful jets of water or heavy seas
	protected against ingress of dust protected against immersion of water between 15cm - 1m for 30 minutes
	protected against ingress of dust protected against immersion of water under pressure for long periods

IK RATING

	protected against 0.14 joules impact (equivalent to 0.25kg mass dropped from 56mm above the surface)
	protected against 0.2 joules impact (equivalent to 0.25kg mass dropped from 80mm above the surface)
	protected against 0.35 joules impact (equivalent to 0.25kg mass dropped from 140mm above the surface)
	protected against 0.5 joules impact (equivalent to 0.25kg mass dropped from 200mm above the surface)
	protected against 0.7 joules impact (equivalent to 0.25kg mass dropped from 280mm above the surface)
	protected against 1 joules impact (equivalent to 0.25kg mass dropped from 400mm above the surface)
	protected against 2 joules impact (equivalent to 0.5kg mass dropped from 400mm above the surface)
	protected against 5 joules impact (equivalent to 1.7kg mass dropped from 300mm above the surface)
	protected against 10 joules impact (equivalent to 5.0kg mass dropped from 200mm above the surface)
	protected against 20 joules impact (equivalent to 5.0kg mass dropped from 400mm above the surface)