

MARK - MONOPOINT SUSPENSION

D141312-

base number Color Finish Finish
 Temperature Options Options

- To build a product code in our configurator select the specify button on the base model # product page
- To build a manual product code on this datasheet choose from the options listed below in blue font and add the suffix to the base model #

GENERAL

Series: Mark
 Subseries: Mark - Monopoint
 Partner: Cangini & Tucci
 Division: Design
 Installation: Suspension
 Product Type: Pendant
 Mounting Location: Ceiling

PHYSICAL

Shape: Oval
 Diameter (mm): 250
 Diameter (in): 9 ¹³/₁₆
 Height (mm): 220
 Height (in): 8 ¹¹/₁₆
 Max. Overall Height (mm): 2220
 Max. Overall Height (in): 86 ⁵/₈
 Weight (kg): 1.20
 Weight (lbs): 2.65
 Fixture Finish: [AMB / BLK / BRZ / GLD / GRN / PNK / RGD / RUB / SKB / SMK / STE / TOB / TRA](#)
 Holder Finish: CHR / BCR / MWH / MBK
 Fixture Material: Glass / Metal
 Primary Material: Glass - Borosilicate
 Cable Details: 2000mm/78 3/4" Transparent Cable

ELECTRICAL

Lamp Type: LED
 Input Wattage (W): 6
 Dimming: Tri-Mode (Non-Dimming and Phase Dimming (120Vac only) and 0-10V Dimming)
 Driver Included: Yes
 Driver Location: Integrated
 Driver Type: Constant Current - Universal
 Driver Class: Class 2
 Input Voltage (V): 120
 Constant Current (MA): 500mA

LED

Number of LEDs: 1
 Color Temperature (°K): [2700 / 3000](#)
 Nominal Lumen (lm): 866
 CRI: >95 CRI
 Efficacy (lm/w): 144
 Lamp Life (hrs): 50000

OPTICAL

RATINGS AND CERTIFICATIONS

Certified By: Certified for North American Standards
 IP rating: IP20

PROJECT
TYPE
SPECIFIER
QUANTITY
DATE



MARK - MONOPOINT SUSPENSION

D141312-

PROJECT _____

TYPE _____

SPECIFIER _____

QUANTITY _____

DATE _____

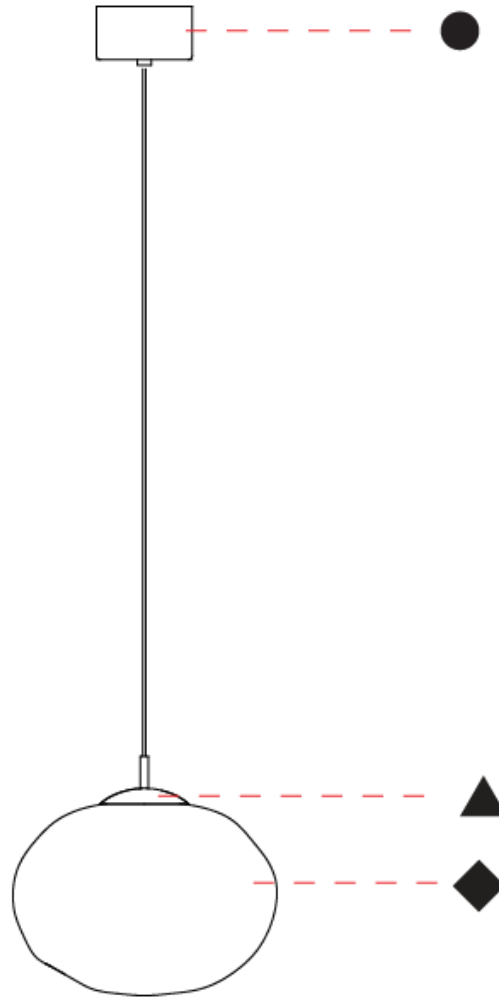

D

MARK - MONOPOINT SUSPENSION

D141314-

base number Color Finish Finish
 Temperature Options Options

- To build a product code in our configurator select the specify button on the base model # product page
- To build a manual product code on this datasheet choose from the options listed below in blue font and add the suffix to the base model #

GENERAL

Series: Mark
 Subseries: Mark - Monopoint
 Partner: Cangini & Tucci
 Division: Design
 Installation: Suspension
 Product Type: Pendant
 Mounting Location: Ceiling

PHYSICAL

Shape: Oval
 Diameter (mm): 250
 Diameter (in): 9 ¹³/₁₆
 Height (mm): 190
 Height (in): 7 ¹/₂
 Max. Overall Height (mm): 2190
 Max. Overall Height (in): 8 ³/₄
 Weight (kg): 1.20
 Weight (lbs): 2.65
 Diffuser: Glass
 Fixture Finish: [AMB / BLK / BRZ / GLD / GRN / PNK / RGD / RUB / SKB / SMK / STE / TOB / TRA](#)
 Holder Finish: [CHR / BCR / MWH / MBK](#)
 Fixture Material: Glass / Metal
 Primary Material: Glass - Borosilicate
 Cable Details: 2000mm/78 3/4" Transparent Cable

ELECTRICAL

Lamp Type: LED
 Input Wattage (W): 6
 Dimming: Tri-Mode (Non-Dimming and Phase Dimming (120Vac only) and 0-10V Dimming)
 Driver Included: Yes
 Driver Location: Integrated
 Driver Type: Constant Current - Universal
 Driver Class: Class 2
 Input Voltage (V): 120
 Constant Current (MA): 500mA

LED

Number of LEDs: 1
 Color Temperature (°K): [2700 / 3000](#)
 Nominal Lumen (lm): 866
 CRI: >95 CRI
 Efficacy (lm/w): 144
 Lamp Life (hrs): 50000

OPTICAL

RATINGS AND CERTIFICATIONS

Certified By: Certified for North American Standards
 IP rating: IP20

PROJECT
TYPE
SPECIFIER
QUANTITY
DATE

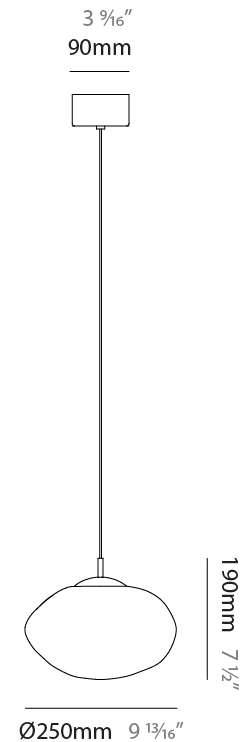

MARK - MONOPOINT SUSPENSION

D141314-

PROJECT
TYPE
SPECIFIER
QUANTITY
DATE

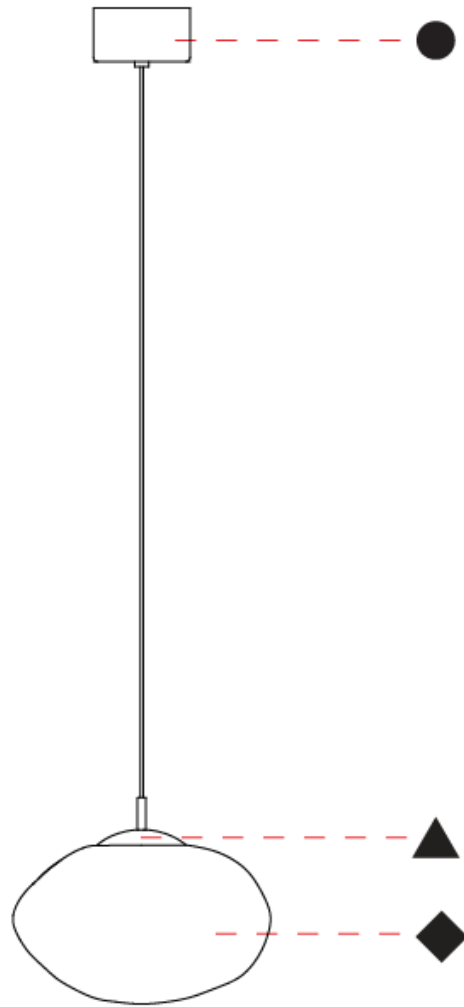

D

MARK - MONOPOINT SUSPENSION

D141316-

base number Color Finish Finish
 Temperature Options Options

- To build a product code in our configurator select the specify button on the base model # product page
- To build a manual product code on this datasheet choose from the options listed below in blue font and add the suffix to the base model #

GENERAL

Series: Mark
 Subseries: Mark - Monopoint
 Partner: Cangini & Tucci
 Division: Design
 Installation: Suspension
 Product Type: Pendant
 Mounting Location: Ceiling

PHYSICAL

Shape: Oval
 Diameter (mm): 300
 Diameter (in): 11 ¹³/₁₆
 Height (mm): 180
 Height (in): 7 ¹/₁₆
 Max. Overall Height (mm): 2180
 Max. Overall Height (in): 85 ¹³/₁₆
 Weight (kg): 1.20
 Weight (lbs): 2.65
 Fixture Finish: [AMB / BLK / BRZ / GLD / GRN / PNK / RGD / RUB / SKB / SMK / STE / TOB / TRA](#)
 Holder Finish: CHR / BCR / MWH / MBK
 Fixture Material: Glass / Metal
 Primary Material: Glass - Borosilicate
 Cable Details: 2000mm/78 3/4" Transparent Cable

ELECTRICAL

Lamp Type: LED
 Input Wattage (W): 6
 Dimming: Tri-Mode (Non-Dimming and Phase Dimming (120Vac only) and 0-10V Dimming)
 Driver Included: Yes
 Driver Location: Integrated
 Driver Type: Constant Current - Universal
 Driver Class: Class 2
 Input Voltage (V): 120
 Constant Current (MA): 500mA

LED

Number of LEDs: 1
 Color Temperature (°K): [2700 / 3000](#)
 Nominal Lumen (lm): 866
 CRI: >95 CRI
 Efficacy (lm/w): 144
 Lamp Life (hrs): 50000

OPTICAL

RATINGS AND CERTIFICATIONS

Certified By: Certified for North American Standards
 IP rating: IP20

PROJECT
TYPE
SPECIFIER
QUANTITY
DATE



MARK - MONOPOINT SUSPENSION

D141316-

PROJECT	_____
TYPE	_____
SPECIFIER	_____
QUANTITY	_____
DATE	_____

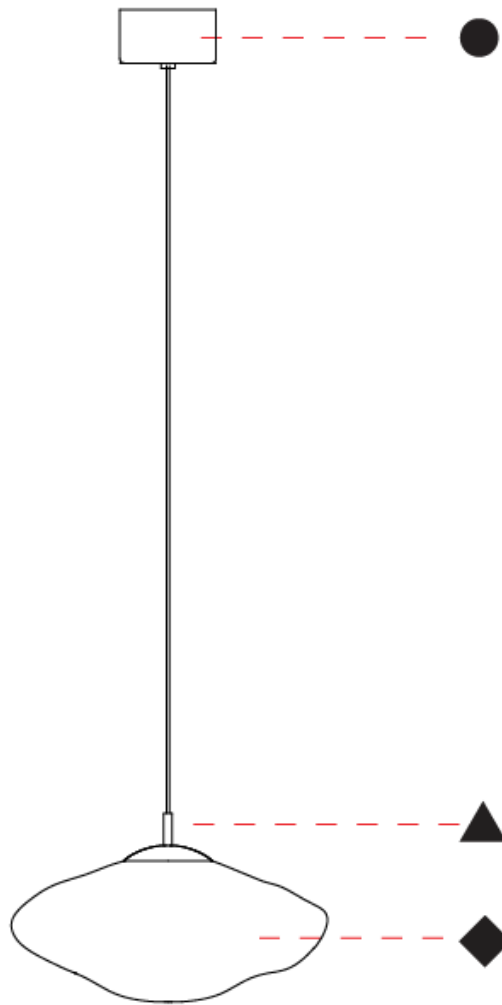

D

MARK PORTABLE

D144050-

base number Color Finish Finish
 Temperature Options Options

- To build a product code in our configurator select the specify button on the base model # product page
- To build a manual product code on this datasheet choose from the options listed below in blue font and add the suffix to the base model #

GENERAL

Series: Mark
 Partner: Cangini & Tucci
 Division: Design
 Installation: Portable
 Product Type: Table
 Mounting Location: Table

PHYSICAL

Shape: Oval
 Diameter (mm): 300
 Diameter (in): 11 ¹³/₁₆
 Height (mm): 480
 Height (in): 18 ⁷/₈
 Weight (kg): 6.50
 Weight (lbs): 14.33
 Fixture Finish: [AMB / BLK / BRZ / GLD / GRN / PNK / RGD / RUB / SKB / SMK / STE / TOB / TRA](#)
 Holder Finish: [SGD / SBK](#)
 Fixture Material: Glass / Metal
 Primary Material: Glass - Borosilicate
 Cable Details: 2000mm/78 3/4" Transparent Cable

ELECTRICAL

Lamp Type: LED
 Input Wattage (W): 6
 Dimming: Tri-Mode (Non-Dimming and Phase Dimming (120Vac only) and 0-10V Dimming)
 Driver Included: Yes
 Driver Location: Integrated
 Driver Type: Constant Current - Universal
 Driver Class: Class 2
 Input Voltage (V): 120
 Constant Current (MA): 500mA

LED

Number of LEDs: 1
 Color Temperature (°K): [2700 / 3000](#)
 Nominal Lumen (lm): 866
 CRI: >95 CRI
 Lamp Life (hrs): 50000

OPTICAL

RATINGS AND CERTIFICATIONS

Certified By: Certified for North American Standards
 IP rating: IP20

PROJECT
TYPE
SPECIFIER
QUANTITY
DATE

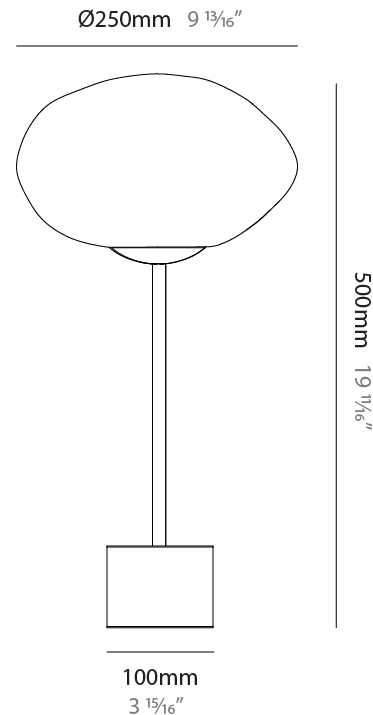

D144050-

PROJECT
TYPE
SPECIFIER
QUANTITY
DATE

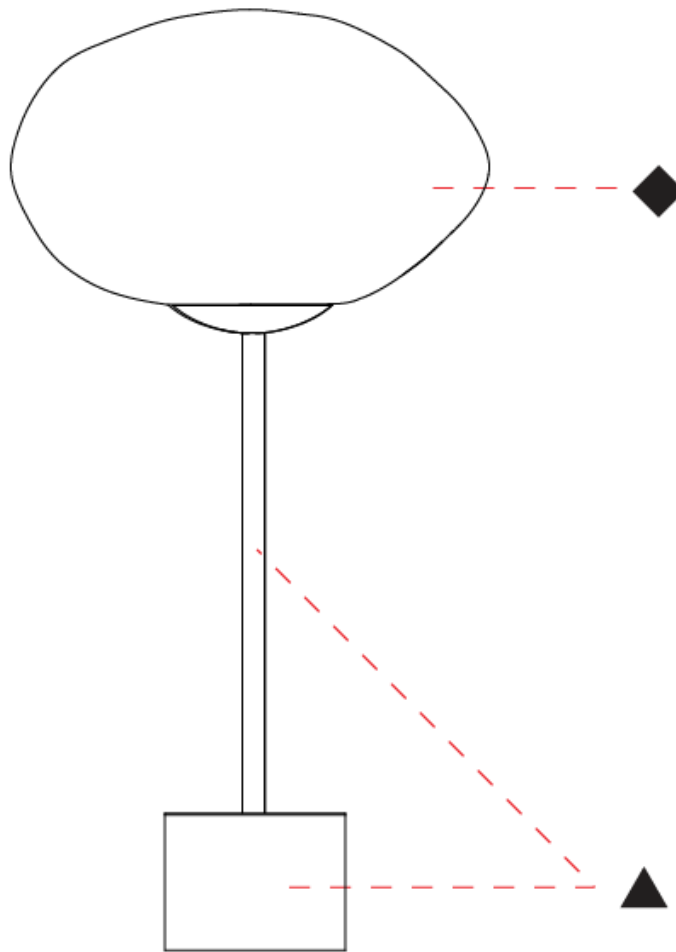

D

MARK PORTABLE

D144051-

base number Color Finish Finish
 Temperature Options Options

- To build a product code in our configurator select the specify button on the base model # product page
- To build a manual product code on this datasheet choose from the options listed below in blue font and add the suffix to the base model #

GENERAL

Series: Mark
 Partner: Cangini & Tucci
 Division: Design
 Installation: Portable
 Product Type: Table
 Mounting Location: Table

PHYSICAL

Shape: Oval
 Diameter (mm): 250
 Diameter (in): 9 ¹³/₁₆
 Height (mm): 500
 Height (in): 19 ¹¹/₁₆
 Weight (kg): 6.50
 Weight (lbs): 14.33
 Fixture Finish: [AMB / BLK / BRZ / GLD / GRN / PNK / RGD / RUB / SKB / SMK / STE / TOB / TRA](#)
 Holder Finish: [SGD / SBK](#)
 Fixture Material: Glass / Metal
 Primary Material: Glass - Borosilicate
 Cable Details: 2000mm/78 3/4" Transparent Cable

ELECTRICAL

Lamp Type: LED
 Input Wattage (W): 6
 Dimming: Tri-Mode (Non-Dimming and Phase Dimming (120Vac only) and 0-10V Dimming)
 Driver Included: Yes
 Driver Location: Integrated
 Driver Type: Constant Current - Universal
 Driver Class: Class 2
 Input Voltage (V): 120
 Constant Current (MA): 500mA

LED

Number of LEDs: 1
 Color Temperature (°K): [2700 / 3000](#)
 Nominal Lumen (lm): 866
 CRI: >95 CRI
 Lamp Life (hrs): 50000

OPTICAL

RATINGS AND CERTIFICATIONS

Certified By: Certified for North American Standards
 IP rating: IP20

PROJECT
TYPE
SPECIFIER
QUANTITY
DATE

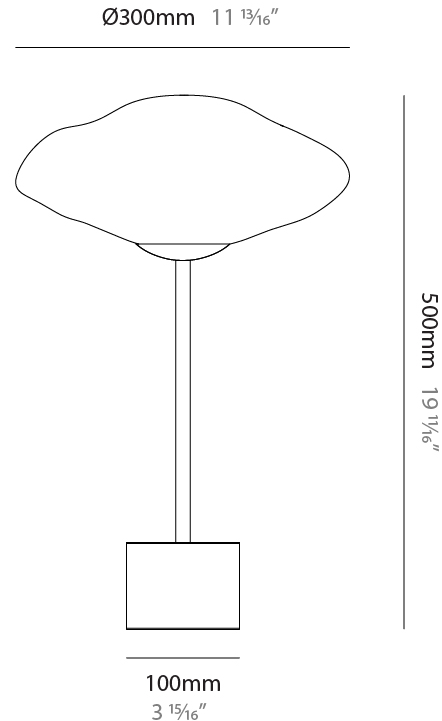

D144051-

PROJECT _____

TYPE _____

SPECIFIER _____

QUANTITY _____

DATE _____

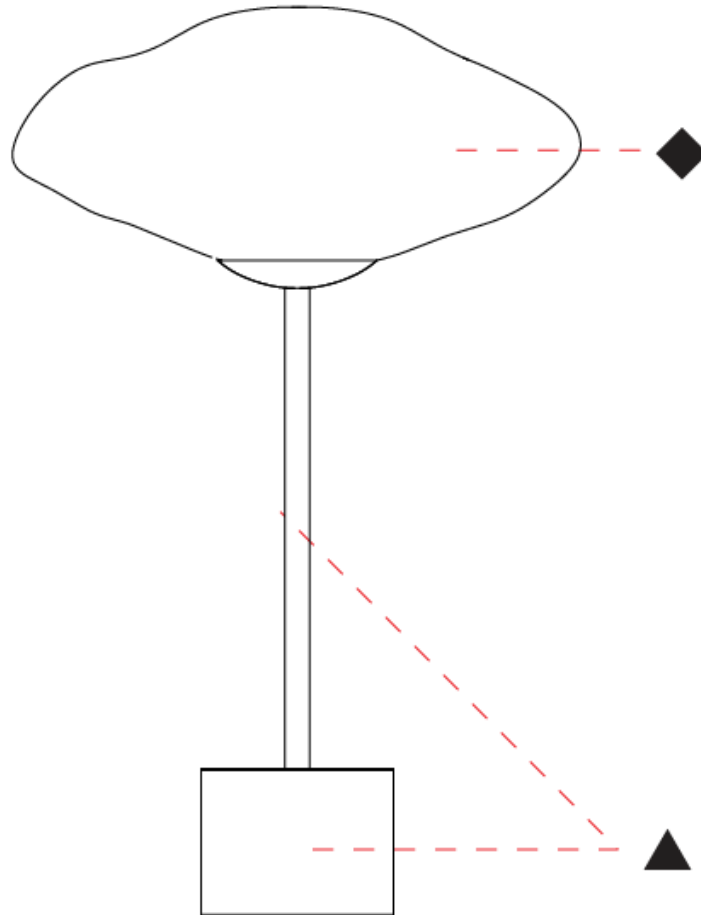

D

MARK PORTABLE

D144053-

base number Color Finish Finish
 Temperature Options Options

- To build a product code in our configurator select the specify button on the base model # product page
- To build a manual product code on this datasheet choose from the options listed below in blue font and add the suffix to the base model #

GENERAL

Series: Mark
 Partner: Cangini & Tucci
 Division: Design
 Installation: Portable
 Product Type: Floor
 Mounting Location: Floor

PHYSICAL

Shape: Oval
 Diameter (mm): 350
 Diameter (in): 13 ³/₄
 Height (mm): 1700
 Height (in): 66 ¹⁵/₁₆
 Weight (kg): 8.0
 Weight (lbs): 17.64
 Fixture Finish: [AMB / BLK / BRZ / GLD / GRN / PNK / RGD / RUB / SKB / SMK / STE / TOB / TRA](#)
 Holder Finish: [SGD / SBK](#)
 Fixture Material: Glass / Metal
 Primary Material: Glass - Borosilicate
 Cable Details: 2000mm/78 3/4" Transparent Cable

ELECTRICAL

Lamp Type: LED
 Input Wattage (W): 12
 Dimming: Tri-Mode (Non-Dimming and Phase Dimming (120Vac only) and 0-10V Dimming)
 Driver Included: Yes
 Driver Location: Integrated
 Driver Type: Constant Current - Universal
 Driver Class: Class 2
 Input Voltage (V): 120
 Constant Current (MA): 500mA

LED

Number of LEDs: 1
 Color Temperature (°K): [2700 / 3000](#)
 Nominal Lumen (lm): 1717
 CRI: >95 CRI
 Lamp Life (hrs): 50000

OPTICAL

RATINGS AND CERTIFICATIONS

Certified By: Certified for North American Standards
 IP rating: IP20

PROJECT
TYPE
SPECIFIER
QUANTITY
DATE



11 ¹³/₁₆"
 Ø300mm

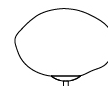

1800mm
 70 ⁷/₈"



160mm
 6 ⁵/₁₆"



D144053-

PROJECT	_____
TYPE	_____
SPECIFIER	_____
QUANTITY	_____
DATE	_____

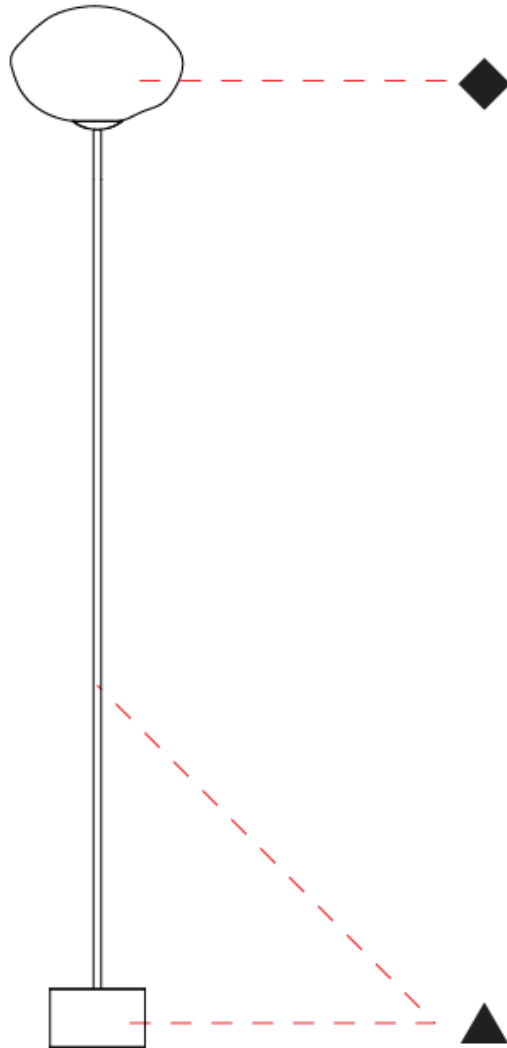

D

MARK PORTABLE

D144054-

base number Color Finish Finish
 Temperature Options Options

- To build a product code in our configurator select the specify button on the base model # product page
- To build a manual product code on this datasheet choose from the options listed below in blue font and add the suffix to the base model #

GENERAL

Series: Mark
 Partner: Cangini & Tucci
 Division: Design
 Installation: Portable
 Product Type: Floor
 Mounting Location: Floor

PHYSICAL

Shape: Oval
 Diameter (mm): 300
 Diameter (in): 11 ¹³/₁₆
 Height (mm): 1800
 Height (in): 70 ⁷/₈
 Weight (kg): 8.0
 Weight (lbs): 17.64
 Fixture Finish: [AMB / BLK / BRZ / GLD / GRN / PNK / RGD / RUB / SKB / SMK / STE / TOB / TRA](#)
 Holder Finish: [SGD / SBK](#)
 Fixture Material: Glass / Metal
 Primary Material: Glass - Borosilicate
 Cable Details: 2000mm/78 3/4" Transparent Cable

ELECTRICAL

Lamp Type: LED
 Input Wattage (W): 12
 Dimming: Tri-Mode (Non-Dimming and Phase Dimming (120Vac only) and 0-10V Dimming)
 Driver Included: Yes
 Driver Location: Integrated
 Driver Type: Constant Current - Universal
 Driver Class: Class 2
 Input Voltage (V): 120
 Constant Current (MA): 500mA

LED

Number of LEDs: 1
 Color Temperature (°K): [2700 / 3000](#)
 Nominal Lumen (lm): 1717
 CRI: >95 CRI
 Lamp Life (hrs): 50000

OPTICAL

RATINGS AND CERTIFICATIONS

Certified By: Certified for North American Standards
 IP rating: IP20

PROJECT
TYPE
SPECIFIER
QUANTITY
DATE

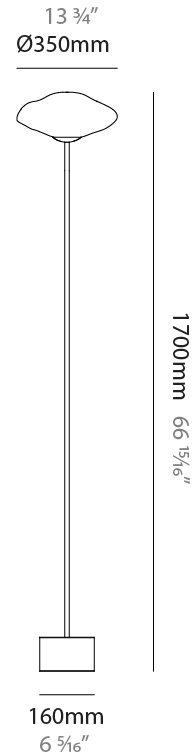

D144054-

PROJECT	_____
TYPE	_____
SPECIFIER	_____
QUANTITY	_____
DATE	_____

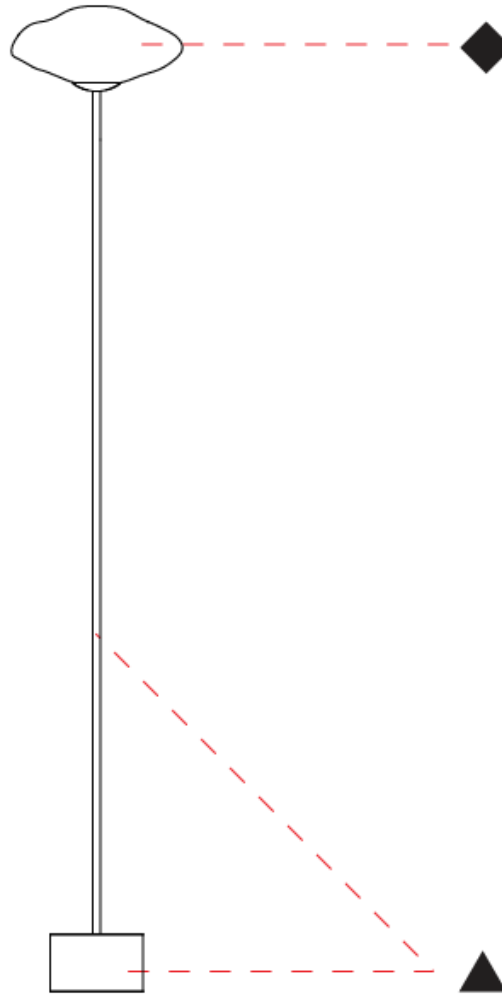

D

PROJECT _____

TYPE _____

SPECIFIER _____

QUANTITY _____

DATE _____

Fixture Finish

Amber - AMB



Black - BLK



Bronze - BRZ

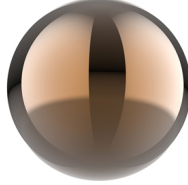

Gold - GLD

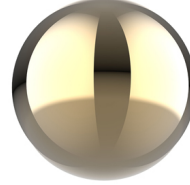

Green - GRN



Pink - PNK



Rose Gold - RGD

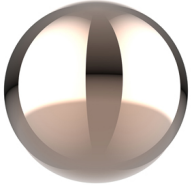

Ruby - RUB



Sky Blue - SKB



Smoke - SMK



Steel - STE



Tobacco - TOB



Transparent - TRA



Holder Finish

Chrome - CHR



Brushed Chrome - BCR



Matte White - MWH

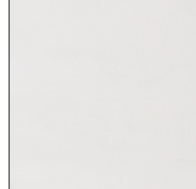

Matte Black - MBK

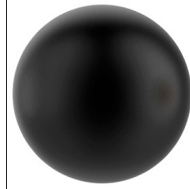

Satin Gold - SGD

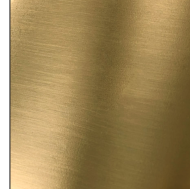

Satin Black Nickel - SBK



Digital: Not all screens are calibrated the same, and therefore, colors will appear differently between screens.

Physical: When texture is involved, there will be variations in color, character and tone within a product series and between product families.

LEGEND

 floor-mounted	 pivotable	 special LED (upon request) RGB, RGBW, tunable, gold+, meat+, art+, fashion+
 wall and ceiling: recessed and surface mounted	 rotating	 warm dim / natural dimming LED
 ceiling-mounted and wall-mounted	 illuminate tilted	 rechargeable battery powered
 wall-mounted	 color of suspension cable	 fixture with natural vivid LED (upon request)
 omni-directional light distribution	 length of suspension cable	 color rendering index
 direct light distribution	 reflector degree selection	 color temperature
 direct/indirect light distribution	 super spot	 lumen (luminous flux)
 indirect light distribution	 lens	 efficacy (lumens per watt)
 asymmetric light distribution	 lens pack	 Unified Glare Rating (UGR) range from 5-40
 aura light distribution	 shine ring	 marine grade (AISI 316 stainless steel)
 round wall or ceiling cut-out	 integrated shine ring with diffuser	 walk on
 square wall or ceiling cut-out	 free individual colors 01-29	 drive on
 the supplied jig specifies the cutout dimensions	 individual colors: 00 (free of charge), 01-25 (extra charge)	 Dark Sky Compliance
 minimum distance (meters) lamp - object	 luminaire part to be colored (F1)	 Americans with Disabilities Act (less than 4" off the wall located between 27"-84" from floor)
 recessed depth	 luminaire part to be colored (F2)	 lamp protected against explosion
 ceiling thickness in mm	 luminaire part to be colored (F3)	 blown glass using traditional methods by master glass blower
 ceiling thickness selection	 luminaire part to be colored (F4)	 acoustic material
 dimmable DP (phase), DV (0-10V), DD (dali), DS (step-dim)	 luminaire part to be colored (F5)	 protection class I, protection insulation
 included or excluded LED driver/transformer/control gear	 color of 3-circuit adaptor	 protection class II, protection insulation
 separately switchable	 indirect diffuser	 ETL Certified to UL and CSA Standards
 sensor	 direct diffuser	 UL Certified to UL and CSA Standards
 remote control	 ball-proof (upon request)	 CSA Certified to UL and CSA Standards
 available upon request	 accessory	 Certified for North American Standards

IP RATING

 IP20	protected against ingress of solid bodies greater than 12.5mm (finger)
 IP33	protected against ingress of solid bodies greater than 2.5mm protected against sprays of water up to 60 degrees from the vertical (rain)
 IP40	protected against ingress of solid bodies greater than 1mm (wire) no protection against the ingress of moisture
 IP43	protected against ingress of solid bodies greater than 1mm (wire) protected against sprays of water up to 60 degrees from the vertical (rain)
 IP44	protected against ingress of solid bodies greater than 1mm (wire) protected against water splashed from all directions
 IP54	protected against limited ingress of dust (wet rooms/covered outdoor areas) protected against water splashed from all directions
 IP65	protected against ingress of dust protected against jets of water
 IP66	protected against ingress of dust protected against powerful jets of water or heavy seas
 IP67	protected against ingress of dust protected against immersion of water between 15cm - 1m for 30 minutes
 IP68	protected against ingress of dust protected against immersion of water under pressure for long periods

IK RATING

 IK01	protected against 0.14 joules impact (equivalent to 0.25kg mass dropped from 56mm above the surface)
 IK02	protected against 0.2 joules impact (equivalent to 0.25kg mass dropped from 80mm above the surface)
 IK03	protected against 0.35 joules impact (equivalent to 0.25kg mass dropped from 140mm above the surface)
 IK04	protected against 0.5 joules impact (equivalent to 0.25kg mass dropped from 200mm above the surface)
 IK05	protected against 0.7 joules impact (equivalent to 0.25kg mass dropped from 280mm above the surface)
 IK06	protected against 1 joules impact (equivalent to 0.25kg mass dropped from 400mm above the surface)
 IK07	protected against 2 joules impact (equivalent to 0.5kg mass dropped from 400mm above the surface)
 IK08	protected against 5 joules impact (equivalent to 1.7kg mass dropped from 300mm above the surface)
 IK09	protected against 10 joules impact (equivalent to 5.0kg mass dropped from 200mm above the surface)
 IK10	protected against 20 joules impact (equivalent to 5.0kg mass dropped from 400mm above the surface)