

MASAI SUSPENSION

D41083-

base number LED Color Finish
 Dimming Temperature Options

- To build a product code in our configurator select the specify button on the base model # product page
- To build a manual product code on this datasheet choose from the options listed below in blue font and add the suffix to the base model #

GENERAL

Series: Masai
 Partner: Icone
 Division: Design
 Installation: Suspension
 Product Type: Pendant
 Mounting Location: Ceiling
 Light Distribution: Indirect

PHYSICAL

Shape: Oval
 Length (mm): 2000
 Length (in): 78 ¾
 Width (mm): 900
 Width (in): 35 7/16
 Height (mm): 500
 Height (in): 19 11/16
 Fixture Finish: WHI / GPB / GPW / GPK / WBB / WBK / SPI / WBI
 Fixture Material: Extruded Aluminum

ELECTRICAL

Lamp Type: LED
 Input Wattage (W): 45
 Dimming: Non-Dimming / Phase Dimming (120vac Only)
 Input Voltage (V): 120Vac Direct Line

LED

Color Temperature (°K): 2700 / 3000
 Nominal Lumen (lm): 3960 / 4320
 CRI: >90 CRI
 Lamp Life (hrs): 50000

OPTICAL

RATINGS AND CERTIFICATIONS

Certified By: Certified for North American Standards
 IP rating: IP20

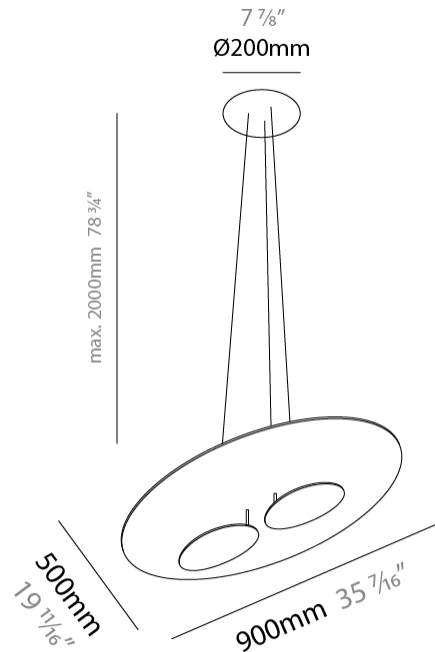

D41083-

PROJECT	_____
TYPE	_____
SPECIFIER	_____
QUANTITY	_____
DATE	_____

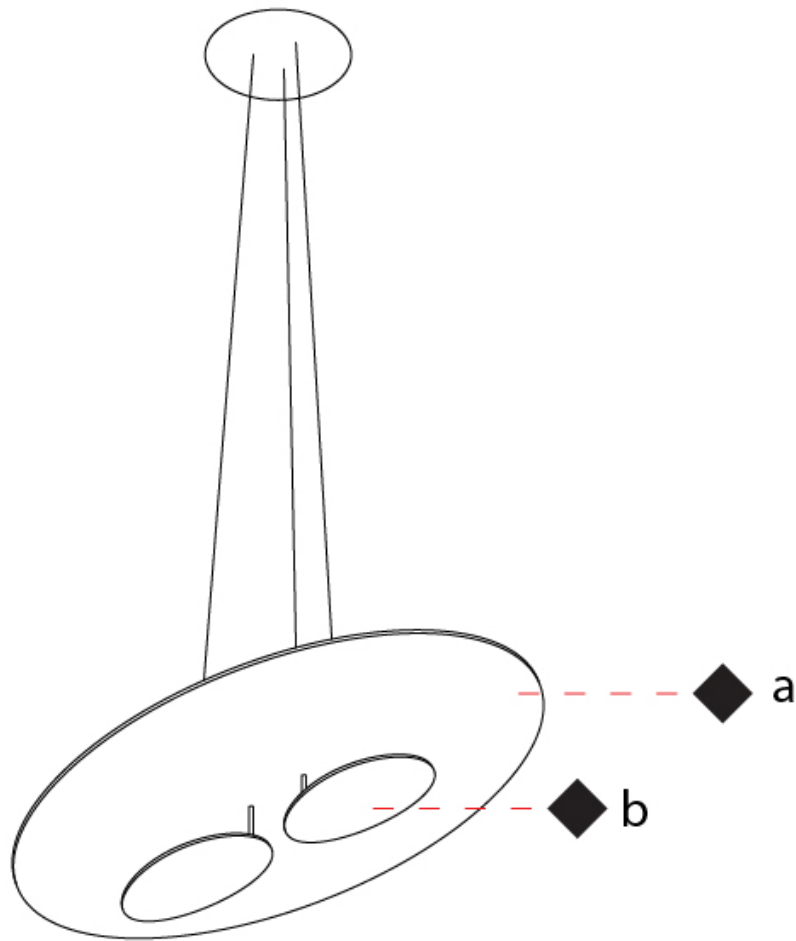

D

PROJECT	
TYPE	
SPECIFIER	
QUANTITY	
DATE	

MASAI SUSPENSION

D41084-

base number LED Dimming Color Temperature Finish Options

- To build a product code in our configurator select the specify button on the base model # product page
- To build a manual product code on this datasheet choose from the options listed below in blue font and add the suffix to the base model #

GENERAL

Series: Masai
 Partner: Icone
 Division: Design
 Installation: Suspension
 Product Type: Pendant
 Mounting Location: Ceiling
 Light Distribution: Indirect

PHYSICAL

Shape: Oval
 Length (mm): 2000
 Length (in): 78 3/4
 Width (mm): 1300
 Width (in): 51 3/16
 Height (mm): 640
 Height (in): 25 3/16
 Fixture Finish: WHI / GPB / GPW / GPK / WBB / WBK / SPI / WBI
 Fixture Material: Extruded Aluminum

ELECTRICAL

Lamp Type: LED
 Input Wattage (W): 60
 Dimming: Non-Dimming / Phase Dimming (120vac Only)
 Input Voltage (V): 120Vac Direct Line

LED

Color Temperature (°K): 2700 / 3000
 Nominal Lumen (lm): 5760
 CRI: >90 CRI
 Lamp Life (hrs): 50000

OPTICAL

RATINGS AND CERTIFICATIONS

Certified By: Certified for North American Standards
 IP rating: IP20



D41084-

PROJECT	_____
TYPE	_____
SPECIFIER	_____
QUANTITY	_____
DATE	_____

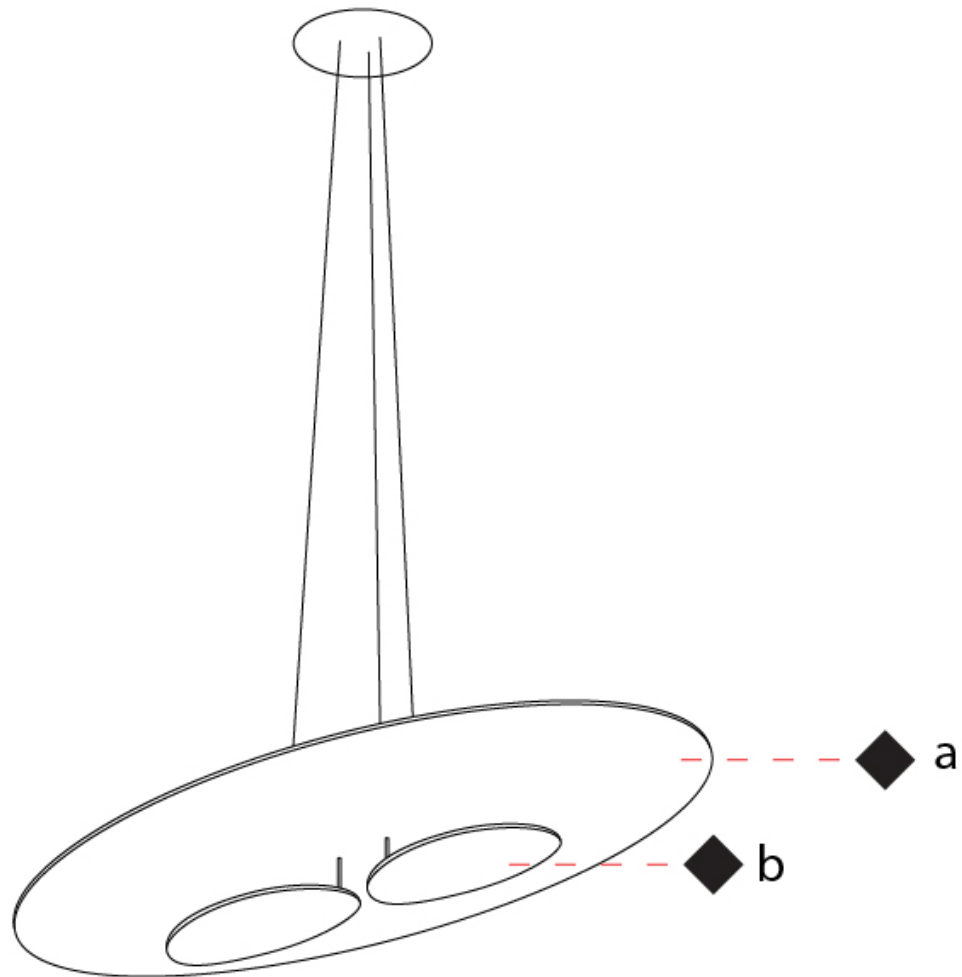

D

MASAI SURFACE

D42087- -

base number Color Finish
 Temperature Options

PROJECT
TYPE
SPECIFIER
QUANTITY
DATE

- To build a product code in our configurator select the specify button on the base model # product page
- To build a manual product code on this datasheet choose from the options listed below in blue font and add the suffix to the base model #

GENERAL

Series: Masai
 Partner: Icone
 Division: Design
 Installation: Surface
 Product Type: Wall Surface
 Mounting Location: Wall
 Light Distribution: Indirect

PHYSICAL

Shape: Oval
 Length (mm): 500
 Length (in): 19 11/16
 Width (mm): 360
 Width (in): 14 3/16
 Height (mm): 140
 Height (in): 5 1/2
[Fixture Finish: WHI / GPB / GPW / GPK / WBB / WBK / SPI / WBI](#)
 Fixture Material: Extruded Aluminum

ELECTRICAL

Lamp Type: LED
 Input Wattage (W): 15
 Dimming: Non-Dimming / Phase Dimming (120vac Only)
 Input Voltage (V): 120Vac Direct Line

LED

[Color Temperature \(°K\): 2700 / 3000](#)
 Nominal Lumen (lm): 1350 / 1440
 CRI: >90 CRI
 Lamp Life (hrs): 50000

OPTICAL

RATINGS AND CERTIFICATIONS

Certified By: Certified for North American Standards
 IP rating: IP20

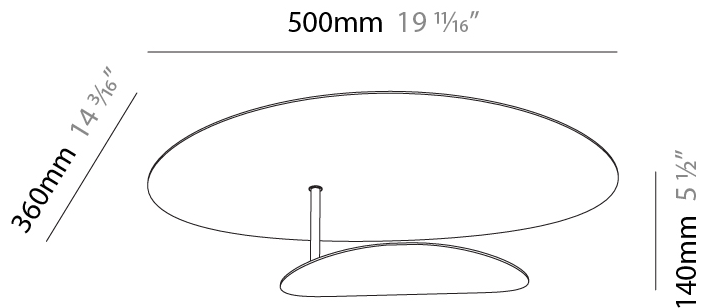

D42087-

PROJECT

TYPE

SPECIFIER

QUANTITY

DATE

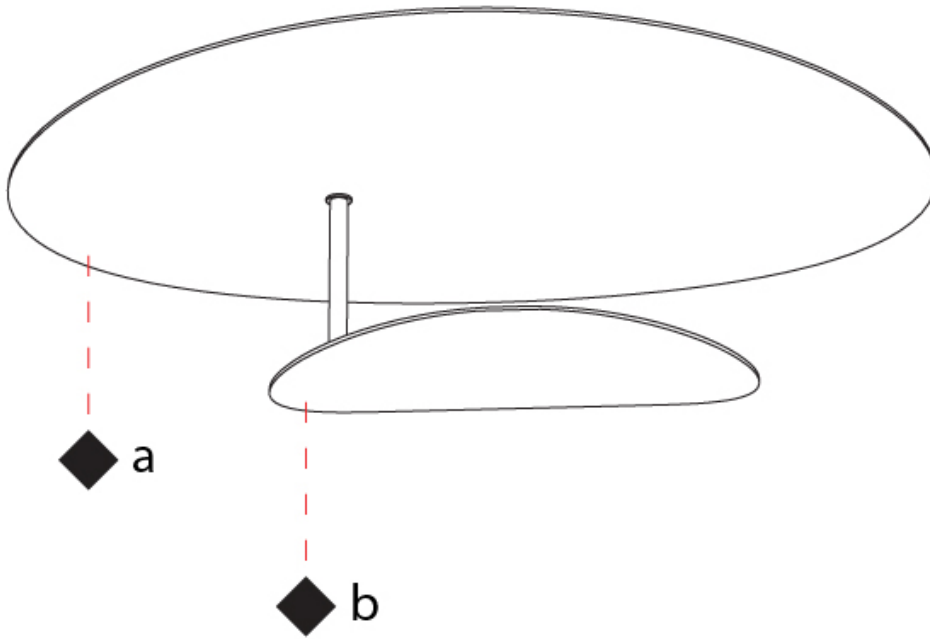

D

PROJECT	_____
TYPE	_____
SPECIFIER	_____
QUANTITY	_____
DATE	_____

MASAI SURFACE

D42088-

base number LED Dimming Color Temperature Finish Options

- To build a product code in our configurator select the specify button on the base model # product page
- To build a manual product code on this datasheet choose from the options listed below in blue font and add the suffix to the base model #

GENERAL

Series: Masai
 Partner: Icone
 Division: Design
 Installation: Surface
 Product Type: Wall Surface
 Mounting Location: Wall
 Light Distribution: Indirect

PHYSICAL

Shape: Oval
 Length (mm): 700
 Length (in): 27 ⁵/₁₆"
 Width (mm): 440
 Width (in): 17 ⁵/₁₆"
 Height (mm): 160
 Height (in): 6 ⁵/₁₆"
 Fixture Finish: WHI / GPB / GPW / GPK / WBB / WBK / SPI / WBI
 Fixture Material: Extruded Aluminum

ELECTRICAL

Lamp Type: LED
 Input Wattage (W): 20
 Dimming: Non-Dimming / Phase Dimming (120vac Only)
 Input Voltage (V): 120Vac Direct Line

LED

Color Temperature (°K): 2700 / 3000
 Nominal Lumen (lm): 1920 / 1960
 CRI: >90 CRI
 Lamp Life (hrs): 50000

OPTICAL

RATINGS AND CERTIFICATIONS

Certified By: Certified for North American Standards
 IP rating: IP20

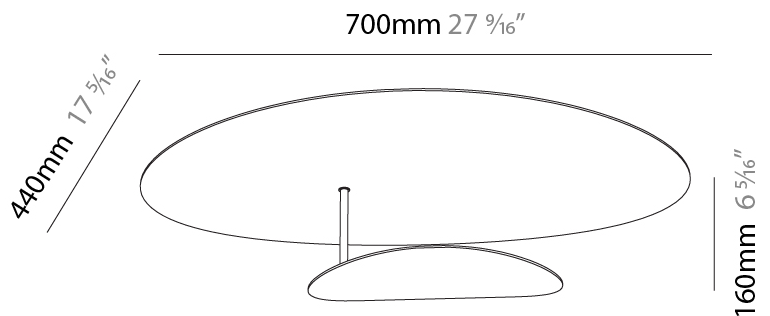
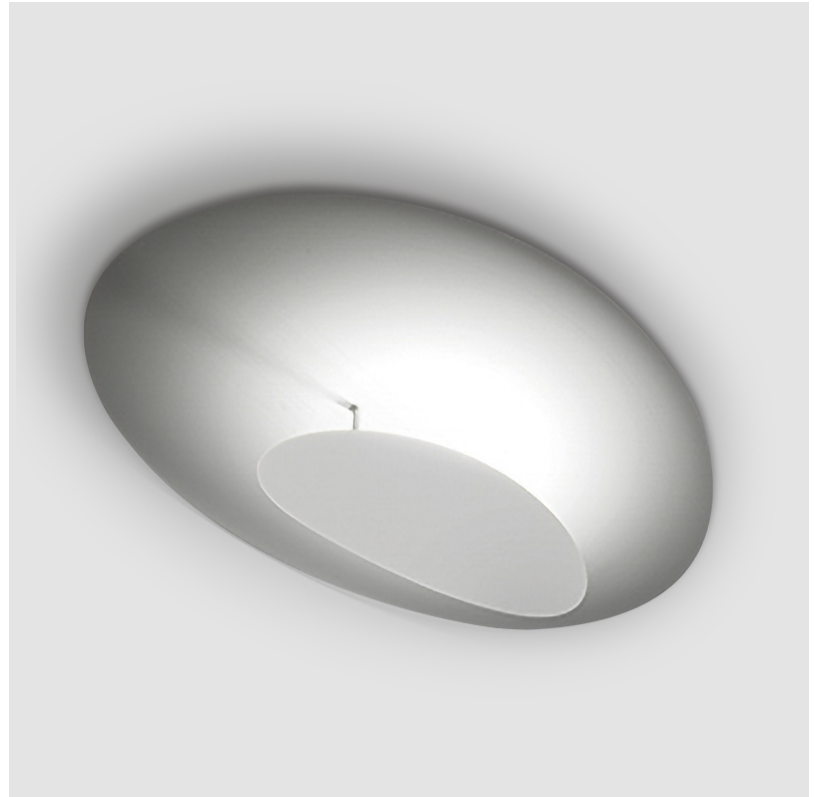

D42088-

PROJECT

TYPE

SPECIFIER

QUANTITY

DATE

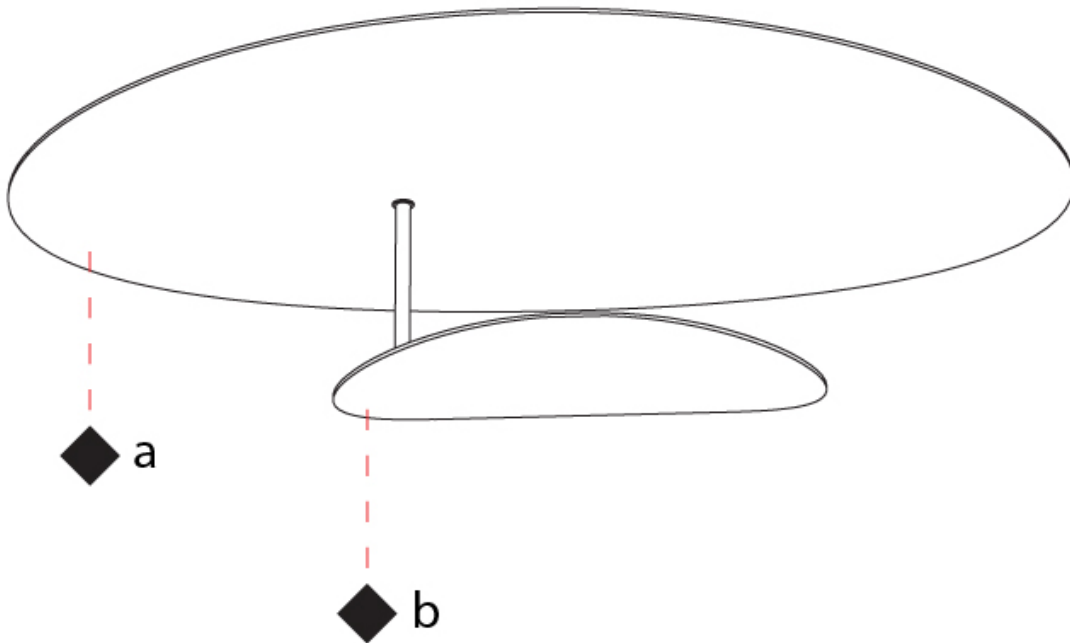

D

MASAI SURFACE

D43077-

base number LED Dimming Color Temperature Finish Options

- To build a product code in our configurator select the specify button on the base model # product page
- To build a manual product code on this datasheet choose from the options listed below in blue font and add the suffix to the base model #

GENERAL

Series: Masai
 Partner: Icone
 Division: Design
 Installation: Surface
 Product Type: Wall Surface
 Mounting Location: Wall
 Light Distribution: Indirect

PHYSICAL

Shape: Oval
 Length (mm): 250
 Length (in): 9 ¹³/₁₆
 Width (mm): 140
 Width (in): 5 ¹/₂
 Height (mm): 130
 Height (in): 5 ¹/₈
[Fixture Finish: WHI / BLK / BBZ / BIN](#)
 Fixture Material: Extruded Aluminum

ELECTRICAL

Lamp Type: LED
 Input Wattage (W): 15
[Dimming: Non-Dimming / Phase Dimming \(120vac Only\)](#)
 Input Voltage (V): 120Vac Direct Line

LED

[Color Temperature \(°K\): 2700 / 3000](#)
 Nominal Lumen (lm): 1320 / 1440
 CRI: >90 CRI
 Lamp Life (hrs): 50000

OPTICAL

RATINGS AND CERTIFICATIONS

Certified By: Certified for North American Standards
 IP rating: IP20

PROJECT
TYPE
SPECIFIER
QUANTITY
DATE



4 ¹/₄"
 Ø108mm

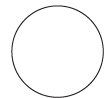

J-Box cover plate
 Included

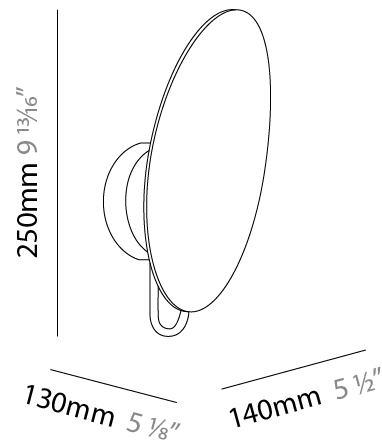

D43077-

PROJECT

TYPE

SPECIFIER

QUANTITY

DATE

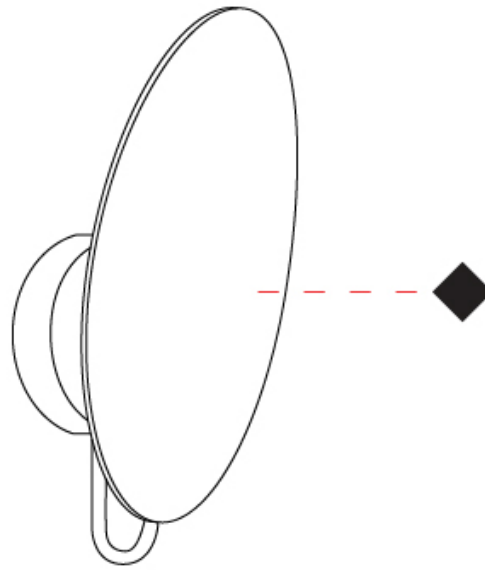

MASAI SURFACE

D43078-

base number LED Dimming Color Temperature Finish Options

- To build a product code in our configurator select the specify button on the base model # product page
- To build a manual product code on this datasheet choose from the options listed below in blue font and add the suffix to the base model #

GENERAL

Series: Masai
 Partner: Icone
 Division: Design
 Installation: Surface
 Product Type: Wall Surface
 Mounting Location: Wall
 Light Distribution: Direct

PHYSICAL

Shape: Oval
 Length (mm): 360
 Length (in): 14 ³/₁₆"
 Width (mm): 180
 Width (in): 7 ¹/₁₆"
 Height (mm): 180
 Height (in): 7 ¹/₁₆"
 Fixture Finish: WHI / BLK / BBZ / BIN
 Fixture Material: Extruded Aluminum

ELECTRICAL

Lamp Type: LED
 Input Wattage (W): 20
 Dimming: Non-Dimming / Phase Dimming (120vac Only)
 Input Voltage (V): 120Vac Direct Line

LED

Color Temperature (°K): 2700 / 3000
 Nominal Lumen (lm): 1920 / 1960
 CRI: >90 CRI
 Lamp Life (hrs): 50000

OPTICAL

RATINGS AND CERTIFICATIONS

Certified By: Certified for North American Standards
 IP rating: IP20

PROJECT
TYPE
SPECIFIER
QUANTITY
DATE

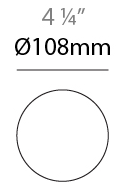
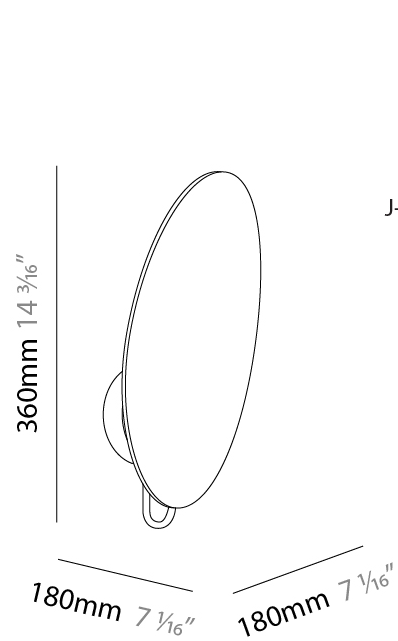

J-Box cover plate
Included



D43078-

PROJECT

TYPE

SPECIFIER

QUANTITY

DATE

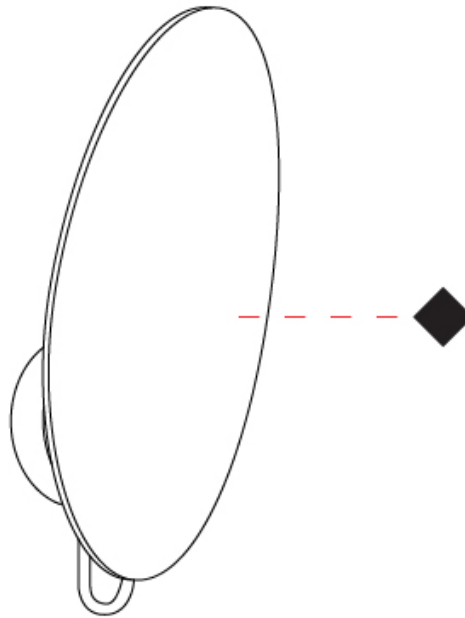

D

MASAI SURFACE

D43079-

base number LED Dimming Color Temperature Finish Options

- To build a product code in our configurator select the specify button on the base model # product page
- To build a manual product code on this datasheet choose from the options listed below in blue font and add the suffix to the base model #

GENERAL

Series: Masai
 Partner: Icone
 Division: Design
 Installation: Surface
 Product Type: Wall Surface
 Mounting Location: Wall
 Light Distribution: Indirect

PHYSICAL

Shape: Oval
 Length (mm): 380
 Length (in): 14 ¹⁵/₁₆
 Width (mm): 220
 Width (in): 8 ¹¹/₁₆
 Height (mm): 160
 Height (in): 6 ⁵/₁₆
[Fixture Finish: WHI / GPB / GPW / GPK / WBB / WBK / SPI / WBI](#)
 Fixture Material: Extruded Aluminum

ELECTRICAL

Lamp Type: LED
 Input Wattage (W): 15
[Dimming: Non-Dimming / Phase Dimming \(120vac Only\)](#)
 Input Voltage (V): 120Vac Direct Line

LED

[Color Temperature \(°K\): 2700 / 3000](#)
 Nominal Lumen (lm): 1320 / 1440
 CRI: >90 CRI
 Lamp Life (hrs): 50000

OPTICAL

RATINGS AND CERTIFICATIONS

Certified By: Certified for North American Standards
 IP rating: IP20

PROJECT
TYPE
SPECIFIER
QUANTITY
DATE

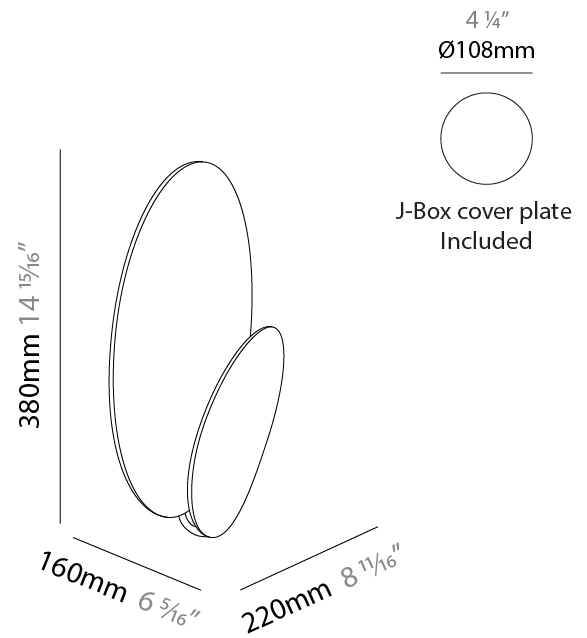
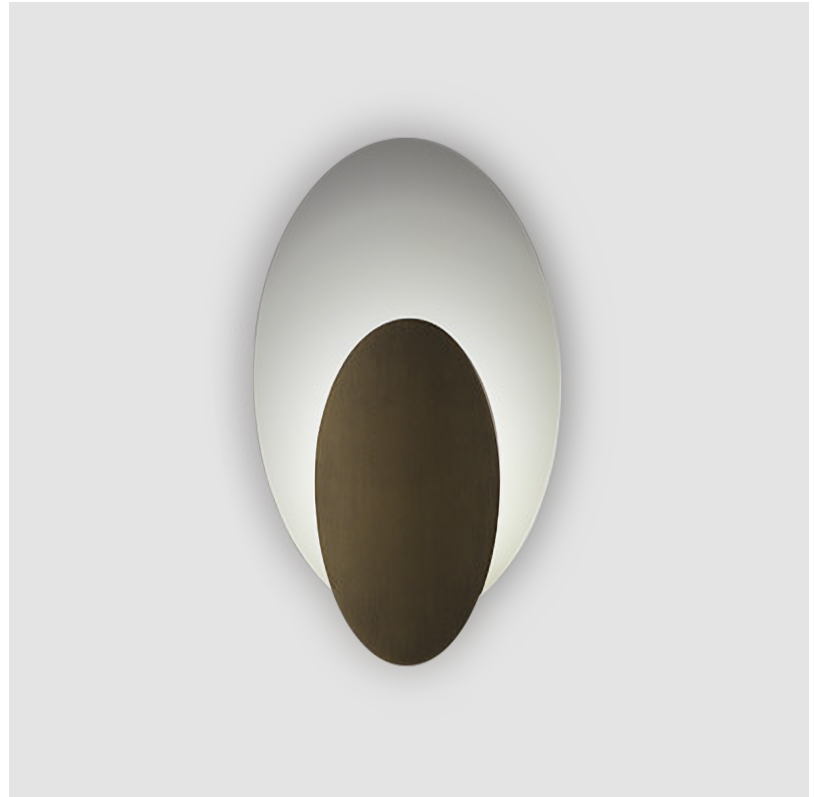

D43079-

PROJECT

TYPE

SPECIFIER

QUANTITY

DATE

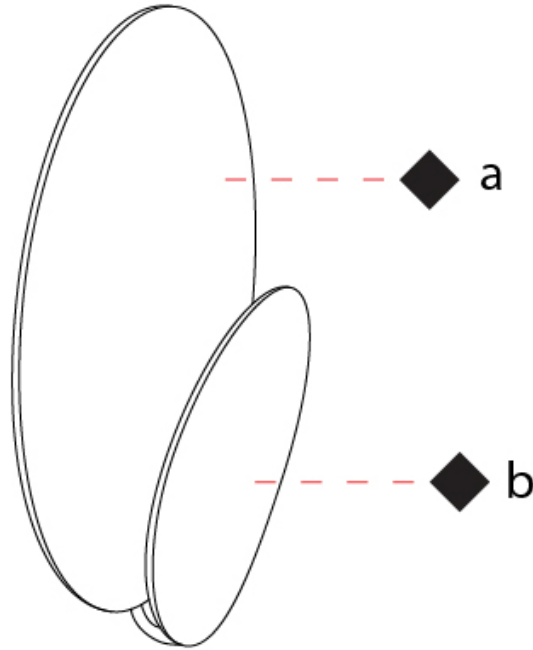

D

PROJECT
TYPE
SPECIFIER
QUANTITY
DATE

MASAI SURFACE

D43080-

base number	LED Dimming	Color Temperature	Finish Options
-------------	-------------	-------------------	----------------

- To build a product code in our configurator select the specify button on the base model # product page
- To build a manual product code on this datasheet choose from the options listed below in blue font and add the suffix to the base model #

GENERAL

Series: Masai
Partner: Icone
Division: Design
Installation: Surface
Product Type: Wall Surface
Mounting Location: Wall
Light Distribution: Indirect

PHYSICAL

Shape: Oval
Length (mm): 500
Length (in): 19 ¹¹ / ₁₆
Width (mm): 280
Width (in): 11
Height (mm): 180
Height (in): 7 ¹ / ₁₆
Fixture Finish: WHI / GPB / GPW / GPK / WBB / WBK / SPI / WBI
Fixture Material: Extruded Aluminum

ELECTRICAL

Lamp Type: LED
Input Wattage (W): 20
Dimming: Non-Dimming / Phase Dimming (120vac Only)
Input Voltage (V): 120Vac Direct Line

LED

Color Temperature (°K): 2700 / 3000
Nominal Lumen (lm): 1920 / 1960
CRI: >90 CRI
Lamp Life (hrs): 50000

OPTICAL

RATINGS AND CERTIFICATIONS

Certified By: Certified for North American Standards
IP rating: IP20

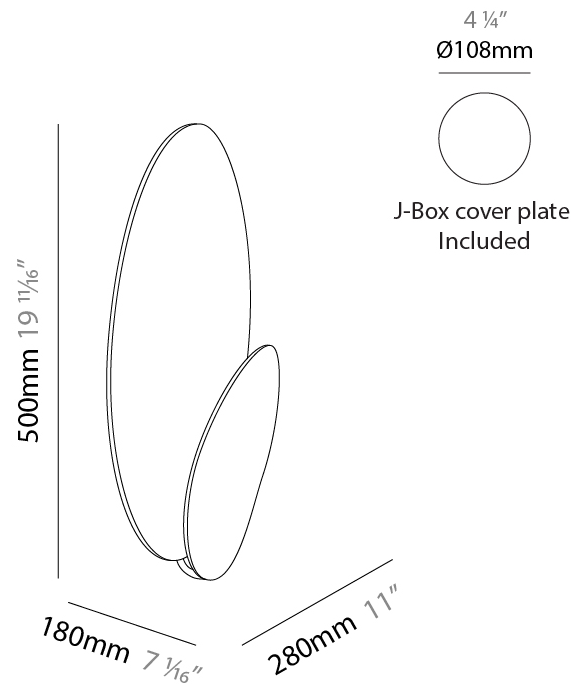

D43080-

PROJECT	_____
TYPE	_____
SPECIFIER	_____
QUANTITY	_____
DATE	_____

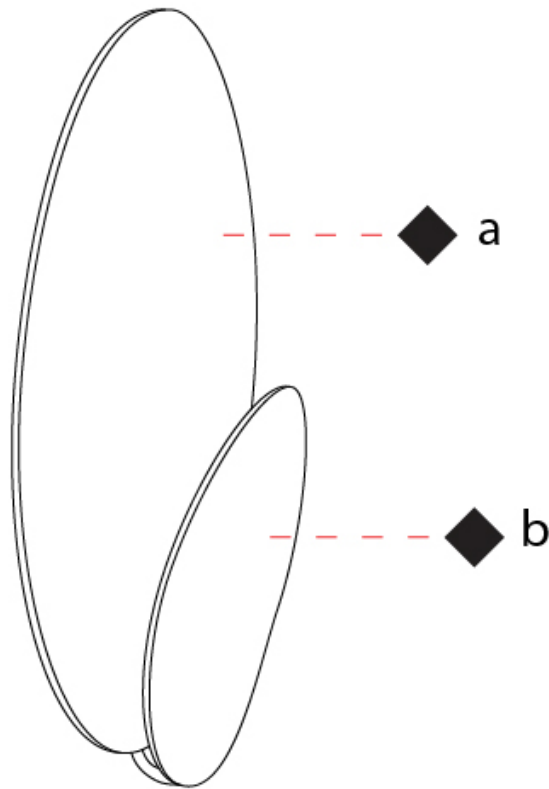

D

PROJECT	_____
TYPE	_____
SPECIFIER	_____
QUANTITY	_____
DATE	_____

MASAI PORTABLE

D44022-

base number	LED	Color	Finish
	Dimming	Temperature	Options

- To build a product code in our configurator select the specify button on the base model # product page
- To build a manual product code on this datasheet choose from the options listed below in blue font and add the suffix to the base model #

GENERAL

Series: Masai
Partner: Icone
Division: Design
Installation: Portable
Product Type: Table
Mounting Location: Table
Light Distribution: Indirect

PHYSICAL

Shape: Oval
Length (mm): 280
Length (in): 11
Width (mm): 140
Width (in): 5 1/2
Height (mm): 490
Height (in): 19 5/16
Fixture Finish: WHI / GPB / GPW / GPK / WBB / WBK / SPI / WBI
Fixture Material: Extruded Aluminum

ELECTRICAL

Lamp Type: LED
Input Wattage (W): 15
Dimming: Non-Dimming / Phase Dimming (120vac Only)
Input Voltage (V): 120Vac Direct Line

LED

Color Temperature (°K): 2700 / 3000
Nominal Lumen (lm): 1320 / 1440
CRI: >90 CRI
Lamp Life (hrs): 50000

OPTICAL

RATINGS AND CERTIFICATIONS

Certified By: Certified for North American Standards
IP rating: IP20

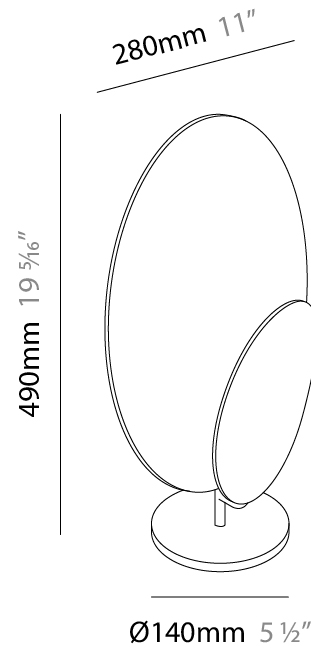

MASAI PORTABLE

D44022-

PROJECT

TYPE

SPECIFIER

QUANTITY

DATE

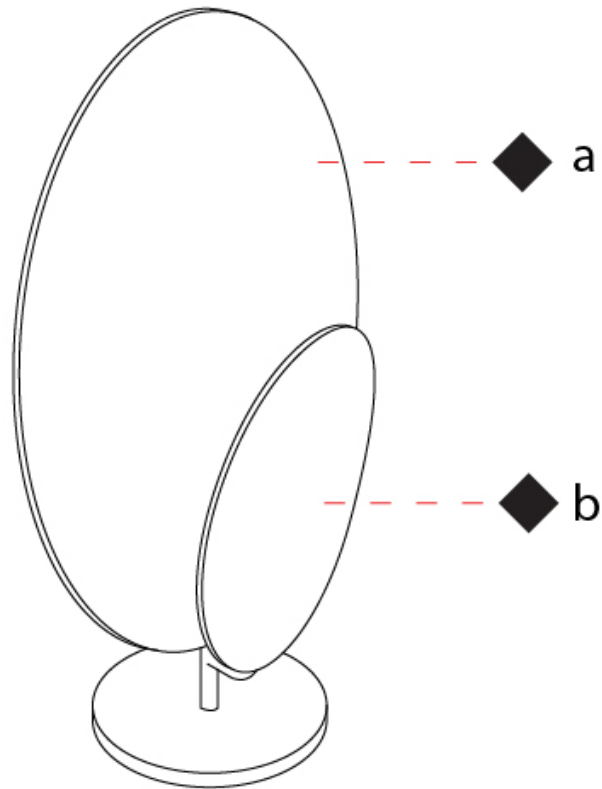

D

PROJECT	_____
TYPE	_____
SPECIFIER	_____
QUANTITY	_____
DATE	_____

MASAI PORTABLE

D44023-

base number	LED	Color	Finish
	Dimming	Temperature	Options

- To build a product code in our configurator select the specify button on the base model # product page
- To build a manual product code on this datasheet choose from the options listed below in blue font and add the suffix to the base model #

GENERAL

Series: Masai
Partner: Icone
Division: Design
Installation: Portable
Product Type: Table
Mounting Location: Table
Light Distribution: Indirect

PHYSICAL

Shape: Oval
Length (mm): 440
Length (in): 17 ⁵ / ₁₆
Width (mm): 200
Width (in): 7 ⁷ / ₈
Height (mm): 740
Height (in): 29 ¹ / ₈
Fixture Finish: WHI / GPB / GPW / GPK / WBB / WBK / SPI / WBI
Fixture Material: Extruded Aluminum

ELECTRICAL

Lamp Type: LED
Input Wattage (W): 20
Dimming: Non-Dimming / Phase Dimming (120vac Only)
Input Voltage (V): 120Vac Direct Line

LED

Color Temperature (°K): 2700 / 3000
Nominal Lumen (lm): 1920 / 1960
CRI: >90 CRI
Lamp Life (hrs): 50000

OPTICAL

RATINGS AND CERTIFICATIONS

Certified By: Certified for North American Standards
IP rating: IP20

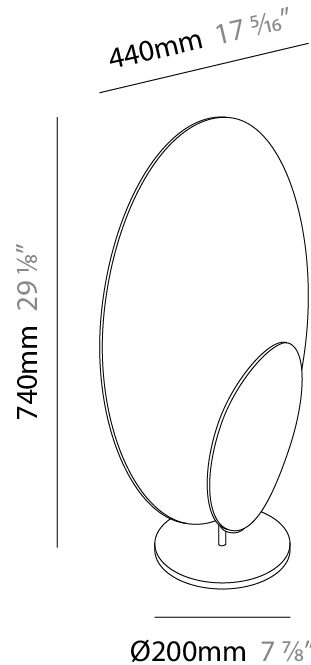

MASAI PORTABLE

D44023-

PROJECT

TYPE

SPECIFIER

QUANTITY

DATE

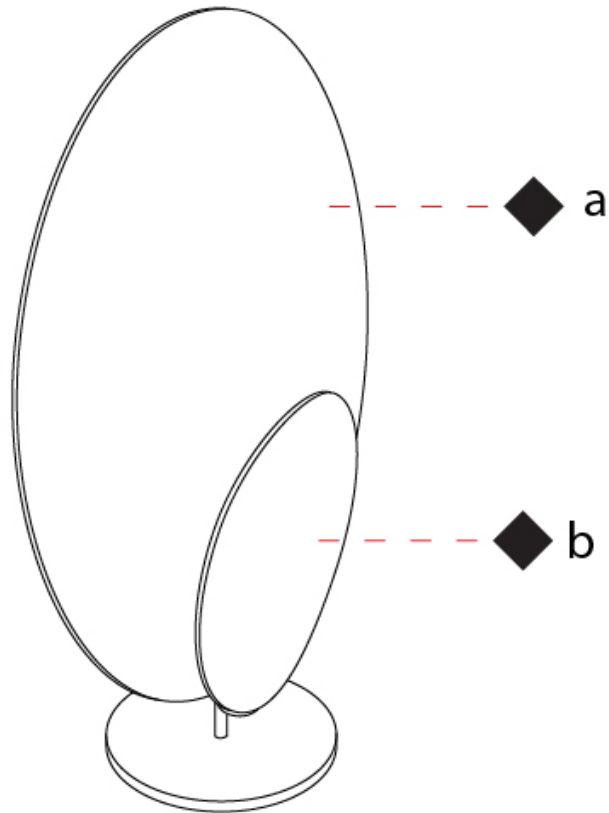

D

MASAI PORTABLE

D44024- - -

base number LED Dimming Color Temperature Finish Options

- To build a product code in our configurator select the specify button on the base model # product page
- To build a manual product code on this datasheet choose from the options listed below in blue font and add the suffix to the base model #

GENERAL

Series: Masai
 Partner: Icone
 Division: Design
 Installation: Portable
 Product Type: Floor
 Mounting Location: Floor
 Light Distribution: Indirect

PHYSICAL

Shape: Oval
 Length (mm): 640
 Length (in): 25 ³/₁₆"
 Width (mm): 300
 Width (in): 11 ¹³/₁₆"
 Height (mm): 1380
 Height (in): 54 ⁵/₁₆"
[Fixture Finish: WHI / GPB / GPW / GPK / WBB / WBK / SPI / WBI](#)
 Fixture Material: Extruded Aluminum

ELECTRICAL

Lamp Type: LED
 Input Wattage (W): 20
[Dimming: Non-Dimming / Phase Dimming \(120vac Only\)](#)
 Input Voltage (V): 120Vac Direct Line

LED

[Color Temperature \(°K\): 2700 / 3000](#)
 Nominal Lumen (lm): 1920 / 1960
 CRI: >90 CRI
 Lamp Life (hrs): 50000

OPTICAL

RATINGS AND CERTIFICATIONS

Certified By: Certified for North American Standards
 IP rating: IP20

PROJECT
TYPE
SPECIFIER
QUANTITY
DATE

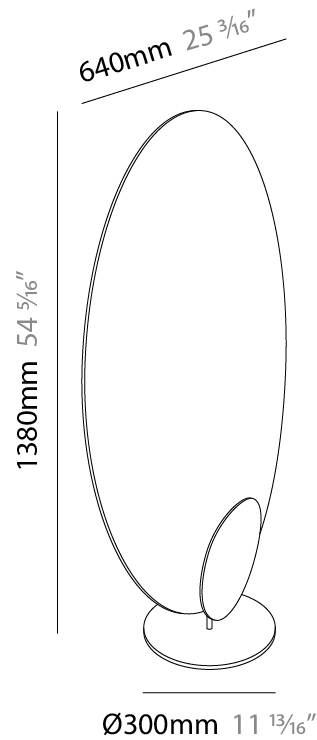

MASAI PORTABLE

D44024-

PROJECT

TYPE

SPECIFIER

QUANTITY

DATE

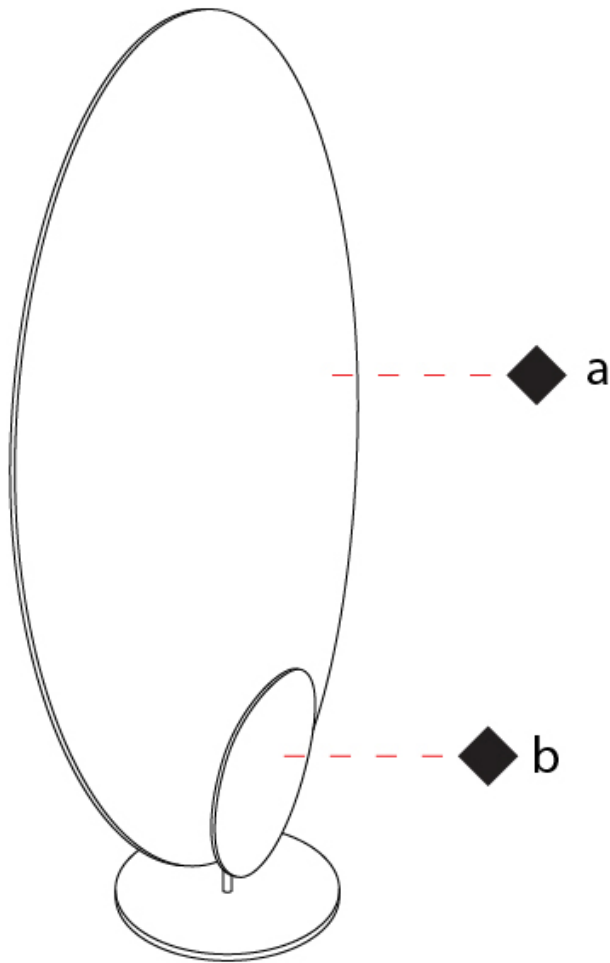

D

MASAI PORTABLE

D44025-

base number LED Dimming Color Temperature Finish Options

- To build a product code in our configurator select the specify button on the base model # product page
- To build a manual product code on this datasheet choose from the options listed below in blue font and add the suffix to the base model #

GENERAL

Series: Masai
 Partner: Icone
 Division: Design
 Installation: Portable
 Product Type: Floor
 Mounting Location: Floor
 Light Distribution: Indirect

PHYSICAL

Shape: Oval
 Length (mm): 640
 Length (in): 25 ³/₁₆"
 Width (mm): 300
 Width (in): 11 ¹³/₁₆"
 Height (mm): 1380
 Height (in): 54 ⁵/₁₆"
[Fixture Finish: WHI / GPB / GPW / GPK / WBB / WBK / SPI / WBI](#)
 Fixture Material: Extruded Aluminum

ELECTRICAL

Lamp Type: LED
 Input Wattage (W): 53
[Dimming: Non-Dimming / Phase Dimming \(120vac Only\)](#)
 Input Voltage (V): 120Vac Direct Line

LED

[Color Temperature \(°K\): 2700 / 3000](#)
 Nominal Lumen (lm): 6920
 CRI: >90 CRI
 Lamp Life (hrs): 50000

OPTICAL

RATINGS AND CERTIFICATIONS

Certified By: Certified for North American Standards
 IP rating: IP20

PROJECT
TYPE
SPECIFIER
QUANTITY
DATE

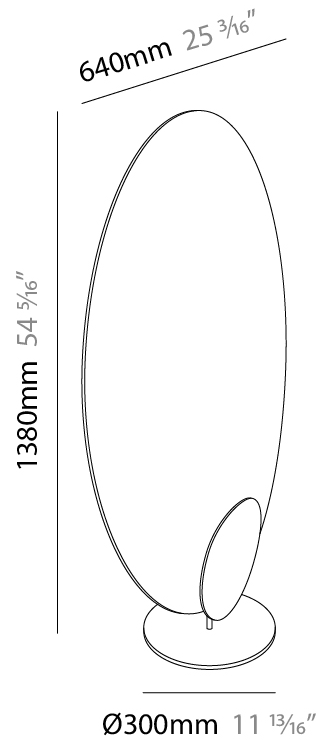

MASAI PORTABLE

D44025-

PROJECT

TYPE

SPECIFIER

QUANTITY

DATE

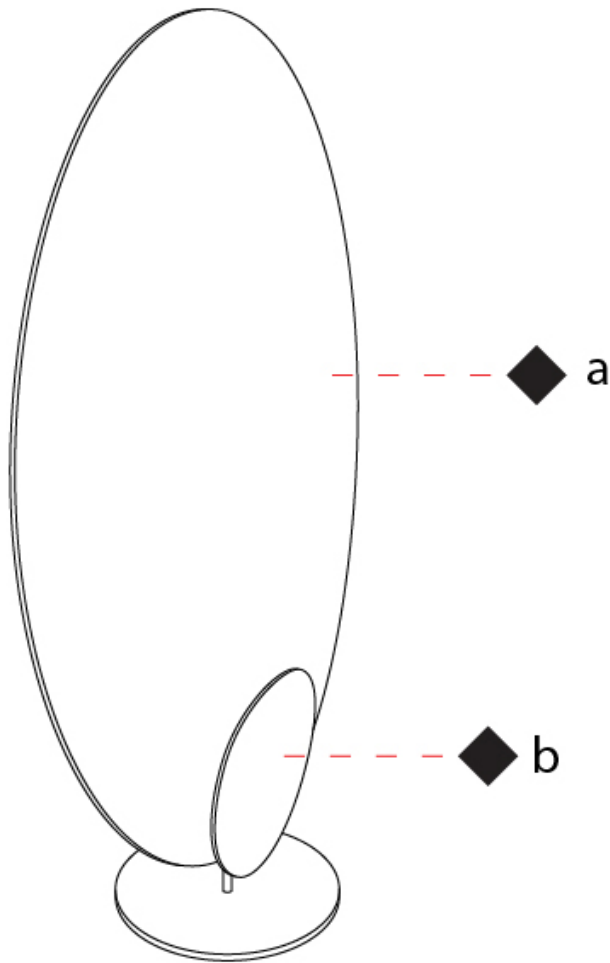

D

MASAI PORTABLE

D44026- - -

base number LED Dimming Color Temperature Finish Options

- To build a product code in our configurator select the specify button on the base model # product page
- To build a manual product code on this datasheet choose from the options listed below in blue font and add the suffix to the base model #

GENERAL

Series: Masai
 Partner: Icone
 Division: Design
 Installation: Portable
 Product Type: Floor
 Mounting Location: Floor
 Light Distribution: Indirect

PHYSICAL

Shape: Oval
 Length (mm): 300
 Length (in): 11 ¹³/₁₆
 Width (mm): 300
 Width (in): 11 ¹³/₁₆
 Height (mm): 1830
 Height (in): 72 ¹/₁₆
[Fixture Finish: WBB / BBB / BBZ / BIN](#)
 Fixture Material: Extruded Aluminum

ELECTRICAL

Lamp Type: LED
 Input Wattage (W): 45
[Dimming: Non-Dimming / Phase Dimming \(120vac Only\)](#)
 Input Voltage (V): 120Vac Direct Line

LED

[Color Temperature \(°K\): 2700 / 3000](#)
 Nominal Lumen (lm): 4050
 CRI: >90 CRI
 Lamp Life (hrs): 50000

OPTICAL

RATINGS AND CERTIFICATIONS

Certified By: Certified for North American Standards
 IP rating: IP20

PROJECT _____
 TYPE _____
 SPECIFIER _____
 QUANTITY _____
 DATE _____

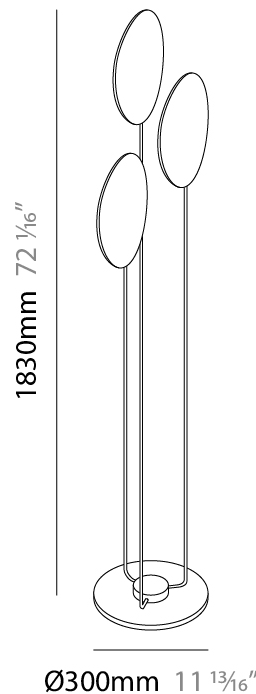

PROJECT	_____
TYPE	_____
SPECIFIER	_____
QUANTITY	_____
DATE	_____

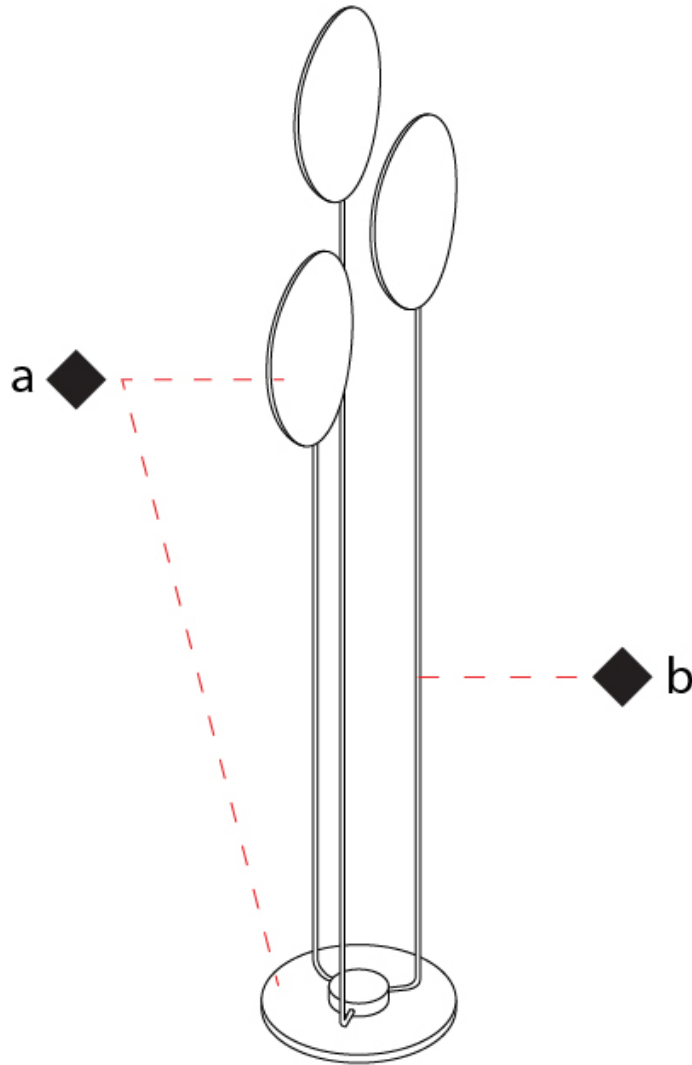

PROJECT	_____
TYPE	_____
SPECIFIER	_____
QUANTITY	_____
DATE	_____

Fixture Finish

White/Brushed Bronze - WBB



Black/Brushed Bronze - BBB

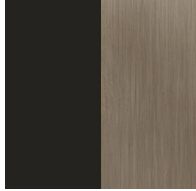

Brushed Bronze - BBZ



Brushed Iron - BIN

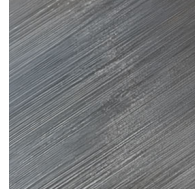

White - WHI

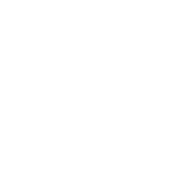

Black - BLK

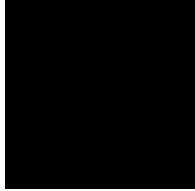

Gold Powder/Brushed Bronze - GPB



Gold Powder/White - GPW



Gold Powder/Black - GPK

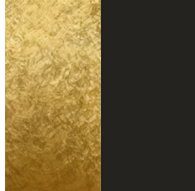

White/Black - WBK



Silver Powder/Brushed Iron - SPI







































































White/Brushed Iron - WBI













Digital: Not all screens are calibrated the same, and therefore, colors will appear differently between screens.

Physical: When texture is involved, there will be variations in color, character and tone within a product series and between product families.











LEGEND

	floor-mounted		pivotal		special LED (upon request) RGB, RGBW, tunable, gold+, meat+, art+, fashion+
	wall and ceiling: recessed and surface mounted		rotating		warm dim / natural dimming LED
	ceiling-mounted and wall-mounted		illuminate tilted		rechargeable battery powered
	wall-mounted		color of suspension cable		fixture with natural vivid LED (upon request)
	omni-directional light distribution		length of suspension cable		color rendering index
	direct light distribution		reflector degree selection		color temperature
	direct/indirect light distribution		super spot		lumen (luminous flux)
	indirect light distribution		lens		efficacy (lumens per watt)
	asymmetric light distribution		lens pack		Unified Glare Rating (UGR) range from 5-40
	aura light distribution		shine ring		marine grade (AISI 316 stainless steel)
	round wall or ceiling cut-out		integrated shine ring with diffuser		walk on
	square wall or ceiling cut-out		free individual colors 01-29		drive on
	the supplied jig specifies the cutout dimensions		individual colors: 00 (free of charge), 01-25 (extra charge)		Dark Sky Compliance
	minimum distance (meters) lamp - object		luminaire part to be colored (F1)		Americans with Disabilities Act (less than 4" off the wall located between 27"-84" from floor)
	recessed depth		luminaire part to be colored (F2)		lamp protected against explosion
	ceiling thickness in mm		luminaire part to be colored (F3)		blown glass using traditional methods by master glass blower
	ceiling thickness selection		luminaire part to be colored (F4)		acoustic material
	dimmable DP (phase), DV (0-10V), DD (dali), DS (step-dim)		luminaire part to be colored (F5)		protection class I, protection insulation
	included or excluded LED driver/transformer/control gear		color of 3-circuit adaptor		protection class II, protection insulation
	separately switchable		indirect diffuser		ETL Certified to UL and CSA Standards
	sensor		direct diffuser		UL Certified to UL and CSA Standards
	remote control		ball-proof (upon request)		CSA Certified to UL and CSA Standards
	available upon request		accessory		Certified for North American Standards

IP RATING

	protected against ingress of solid bodies greater than 12.5mm (finger)
	protected against ingress of solid bodies greater than 2.5mm protected against sprays of water up to 60 degrees from the vertical (rain)
	protected against ingress of solid bodies greater than 1mm (wire) no protection against the ingress of moisture
	protected against ingress of solid bodies greater than 1mm (wire) protected against sprays of water up to 60 degrees from the vertical (rain)
	protected against ingress of solid bodies greater than 1mm (wire) protected against water splashed from all directions
	protected against limited ingress of dust (wet rooms/covered outdoor areas) protected against water splashed from all directions
	protected against ingress of dust protected against jets of water
	protected against ingress of dust protected against powerful jets of water or heavy seas
	protected against ingress of dust protected against immersion of water between 15cm - 1m for 30 minutes
	protected against ingress of dust protected against immersion of water under pressure for long periods

IK RATING

	protected against 0.14 joules impact (equivalent to 0.25kg mass dropped from 56mm above the surface)
	protected against 0.2 joules impact (equivalent to 0.25kg mass dropped from 80mm above the surface)
	protected against 0.35 joules impact (equivalent to 0.25kg mass dropped from 140mm above the surface)
	protected against 0.5 joules impact (equivalent to 0.25kg mass dropped from 200mm above the surface)
	protected against 0.7 joules impact (equivalent to 0.25kg mass dropped from 280mm above the surface)
	protected against 1 joules impact (equivalent to 0.25kg mass dropped from 400mm above the surface)
	protected against 2 joules impact (equivalent to 0.5kg mass dropped from 400mm above the surface)
	protected against 5 joules impact (equivalent to 1.7kg mass dropped from 300mm above the surface)
	protected against 10 joules impact (equivalent to 5.0kg mass dropped from 200mm above the surface)
	protected against 20 joules impact (equivalent to 5.0kg mass dropped from 400mm above the surface)