

## MEDIO RECESSED

**E91278-** -

base number Color Lens  
Temperature Options

- To build a product code in our configurator select the specify button on the base model # product page
- To build a manual product code on this datasheet choose from the options listed below in blue font and add the suffix to the base model #

### GENERAL

Series: Medio  
Subseries: Medio  
Brand: Platek  
Division: Exterior  
Mounting Type: Recessed  
Mounting Location: In-Ground  
Subcategory: Drive Over

### PHYSICAL

Shape: Round  
Diameter (mm): 206  
Diameter (in): 8 1/8  
Height (mm): 230  
Height (in): 9 1/16  
Light Distribution: Uplight  
Weight (kg): 3.3  
Weight (lbs): 7.3  
Load Resistance (kg): 2000  
Load Resistance (lbs): 4409  
Installation Requirement: Installation in sleeve set in concrete with a 20-30 cm gravel drain bed  
Screws: A4 stainless steel  
Diffuser: Clear tempered glass  
Fixture Finish: BLK  
Fixture Material: Aluminum Die Cast  
Cable Details: Supplied with 1 power cable 1.5m in length

### ELECTRICAL

Lamp Type: LED  
Input Wattage (W): 21  
Total Output Wattage (W): 18.5  
Dimming: Non-Dimming / Phase Dimming (120vac Only)  
Driver Included: Yes  
Driver Location: Integrated  
Driver Type: Constant Current - Universal  
Driver Class: Class 2  
Input Voltage (V): 120 - 277  
Constant Current (MA): 700  
Upon Request: (Not included - see components [IP65 or higher enclosure to be supplied by others]) Remote: 0-10Vdc dimming

### LED

Number of LEDs: 9  
Color Temperature (°K): 3000 / 4000  
Max. Delivered Lumen (lm): 1440 - 2080  
CRI: >80 CRI  
Lamp Life (hrs): 60000

### OPTICAL

Optic: 9 / 28 / 45 / Asy  
Beam Angle: Spot / Medium / Wide / Asymmetrical  
Adjustability: Tilt 15°

### RATINGS AND CERTIFICATIONS

Certified By: Certified for North American Standards  
IP rating: IP68  
IK Rating: IK10  
Upon Request: Higher Maximum Ambient Temperature

PROJECT	
TYPE	
SPECIFIER	
QUANTITY	
DATE	



Ø214mm 8 7/16"

Ø153mm 6"



230mm 9 1/16"

260mm 10 1/4"



E91278-

PROJECT	_____
TYPE	_____
SPECIFIER	_____
QUANTITY	_____
DATE	_____



...



## MEDIO SS RECESSED

### E91302-

base number            Color            Lens             
 Temperature Options

PROJECT	_____
TYPE	_____
SPECIFIER	_____
QUANTITY	_____
DATE	_____

- To build a product code in our configurator select the specify button on the base model # product page
- To build a manual product code on this datasheet choose from the options listed below in blue font and add the suffix to the base model #

#### GENERAL

Series: Medio  
 Subseries: Medio SS  
 Brand: Platek  
 Division: Exterior  
 Mounting Type: Recessed  
 Mounting Location: In-Ground  
 Subcategory: Drive Over

#### PHYSICAL

Shape: Round  
 Diameter (mm): 224  
 Diameter (in): 8 <sup>13</sup>/<sub>16</sub>  
 Height (mm): 230  
 Height (in): 9 <sup>1</sup>/<sub>16</sub>  
 Light Distribution: Uplight  
 Weight (kg): 4.4  
 Weight (lbs): 9.7  
 Load Resistance (kg): 2000  
 Load Resistance (lbs): 4409  
 Installation Requirement: Installation in sleeve set in concrete with a 20-30 cm gravel drain bed  
 Screws: A4 stainless steel  
 Diffuser: Clear tempered glass  
 Fixture Finish: SST  
 Fixture Material: Aluminum Die Cast  
 Cable Details: Supplied with 1 power cable 1.5m in length

#### ELECTRICAL

Lamp Type: LED  
 Input Wattage (W): 22  
 Total Output Wattage (W): 19  
 Dimming: Non-Dimming / Phase Dimming (120vac Only)  
 Driver Included: Yes  
 Driver Location: Integrated  
 Driver Type: Constant Current - Universal  
 Driver Class: Class 2  
 Input Voltage (V): 120 - 277  
 Constant Current (MA): 700  
 Upon Request: (Not included - see components [IP65 or higher enclosure to be supplied by others]) Remote: 0-10Vdc dimming

#### LED

Number of LEDs: 9  
 Color Temperature (°K): 3000 / 4000  
 Max. Delivered Lumen (lm): 2000 - 2080  
 Nominal Lumen (lm): 2250 / 2340  
 CRI: >80 CRI  
 Lamp Life (hrs): 60000

#### OPTICAL

Optic: 9 / 28 / 45 / ASY  
 Adjustability: Tilt 15°

#### RATINGS AND CERTIFICATIONS

Certified By: Certified for North American Standards  
 IP rating: IP68  
 IK Rating: IK10  
 Upon Request: Higher Maximum Ambient Temperature



Ø214mm 8 7/16"

Ø153mm 6"



230mm 9 1/16"

260mm 10 1/4"



E9I302-

PROJECT	_____
TYPE	_____
SPECIFIER	_____
QUANTITY	_____
DATE	_____



...



PROJECT	_____
TYPE	_____
SPECIFIER	_____
QUANTITY	_____
DATE	_____

## MEDIO ROLL OVER RECESSED

### E91339-

base number          Color          Finish           
 Temperature          Options         

- To build a product code in our configurator select the specify button on the base model # product page
- To build a manual product code on this datasheet choose from the options listed below in blue font and add the suffix to the base model #

#### GENERAL

Series: Medio  
 Subseries: Medio Roll Over  
 Brand: Platek  
 Division: Exterior  
 Mounting Type: Recessed  
 Mounting Location: In-Ground  
 Subcategory: Marker

#### PHYSICAL

Shape: Round  
 Diameter (mm): 222  
 Diameter (in): 8 ¾  
 Height (mm): 286  
 Height (in): 11 ¼  
 Light Distribution: Direct  
 Weight (kg): 4.3  
 Weight (lbs): 9.5  
 Load Resistance (kg): 2000  
 Load Resistance (lbs): 4409  
 Diffuser: Clear tempered glass  
 Fixture Finish: [BLK](#) / [WHI](#) / [GRY](#) / [COR](#) / [ANT](#) / [BRZ](#)  
 Fixture Material: Aluminum Die Cast  
 Cable Details: Supplied with 1 power cable 1m in length

#### ELECTRICAL

Lamp Type: LED  
 Input Wattage (W): 4.7  
 Total Output Wattage (W): 3  
 Dimming: Non-Dimmable  
 Driver Included: Yes  
 Driver Location: Integrated  
 Driver Type: Constant Current - 120 / 277Vac  
 Driver Class: Class 2  
 Input Voltage (V): 120 - 277  
 Constant Current (MA): 500  
 Upon Request: Remote: 0-10Vdc dimming / Phase dimming

#### LED

Number of LEDs: 2  
 Color Temperature (°K): [3000](#) / [4000](#)  
 Max. Delivered Lumen (lm): 110 / 115  
 Nominal Lumen (lm): 380 / 400  
 CRI: >80 CRI  
 Lamp Life (hrs): 60000

#### OPTICAL

Optic: 1 Opening  
 Beam Angle: 120

#### RATINGS AND CERTIFICATIONS

Certified By: Certified for North American Standards  
 IP rating: IP68  
 IK Rating: IK10  
 Upon Request: Higher Maximum Ambient Temperature

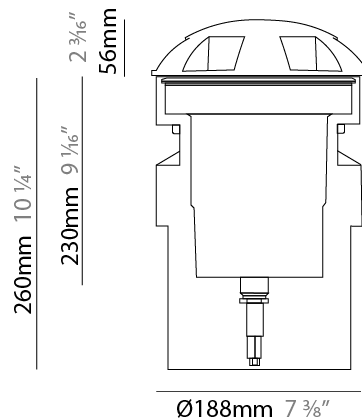
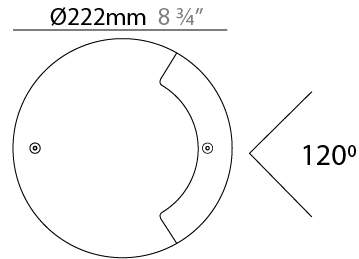

## MEDIO ROLL OVER RECESSED

E9I339-

PROJECT	_____
TYPE	_____
SPECIFIER	_____
QUANTITY	_____
DATE	_____

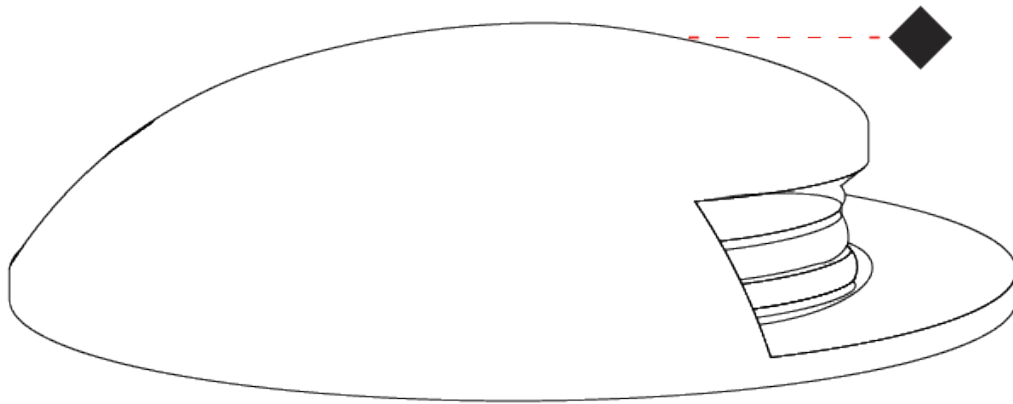

PROJECT	_____
TYPE	_____
SPECIFIER	_____
QUANTITY	_____
DATE	_____

## MEDIO ROLL OVER RECESSED

### E91343-

base number    Color    Finish  
 Temperature    Options

- To build a product code in our configurator select the specify button on the base model # product page
- To build a manual product code on this datasheet choose from the options listed below in blue font and add the suffix to the base model #

#### GENERAL

Series: Medio  
 Subseries: Medio Roll Over  
 Brand: Platek  
 Division: Exterior  
 Mounting Type: Recessed  
 Mounting Location: In-Ground  
 Subcategory: Marker

#### PHYSICAL

Shape: Round  
 Diameter (mm): 222  
 Diameter (in): 8 ¾  
 Height (mm): 286  
 Height (in): 11 ¼  
 Light Distribution: Direct  
 Weight (kg): 4.3  
 Weight (lbs): 9.5  
 Load Resistance (kg): 2000  
 Load Resistance (lbs): 4409  
 Screws: A4 stainless steel  
 Diffuser: Clear tempered glass  
 Fixture Finish: BLK / WHI / GRY / COR / ANT / BRZ  
 Fixture Material: Aluminum Die Cast  
 Cable Details: Supplied with 1 power cable 1m in length

#### ELECTRICAL

Lamp Type: LED  
 Input Wattage (W): 8.3  
 Total Output Wattage (W): 6  
 Dimming: Non-Dimmable  
 Driver Included: Yes  
 Driver Location: Integrated  
 Driver Type: Constant Current - Universal  
 Driver Class: Class 2  
 Input Voltage (V): 120 - 277  
 Constant Current (MA): 500  
 Upon Request: (Not included - see components [IP65 or higher enclosure to be supplied by others]) Remote: 0-10Vdc dimming / Phase dimming

#### LED

Number of LEDs: 4  
 Color Temperature (°K): 3000 / 4000  
 Max. Delivered Lumen (lm): 240 / 250  
 Nominal Lumen (lm): 760 / 800  
 CRI: >80 CRI  
 Lamp Life (hrs): 60000

#### OPTICAL

Optic°: 2 Openings  
 Beam Angle: 120

#### RATINGS AND CERTIFICATIONS

Certified By: Certified for North American Standards  
 IP rating: IP68  
 IK Rating: IK10  
 Upon Request: Higher Maximum Ambient Temperature

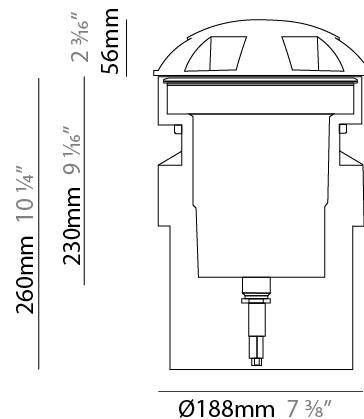
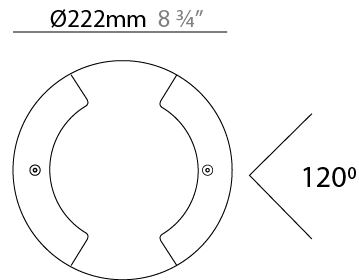

## MEDIO ROLL OVER RECESSED

E9I343-

PROJECT	_____
TYPE	_____
SPECIFIER	_____
QUANTITY	_____
DATE	_____

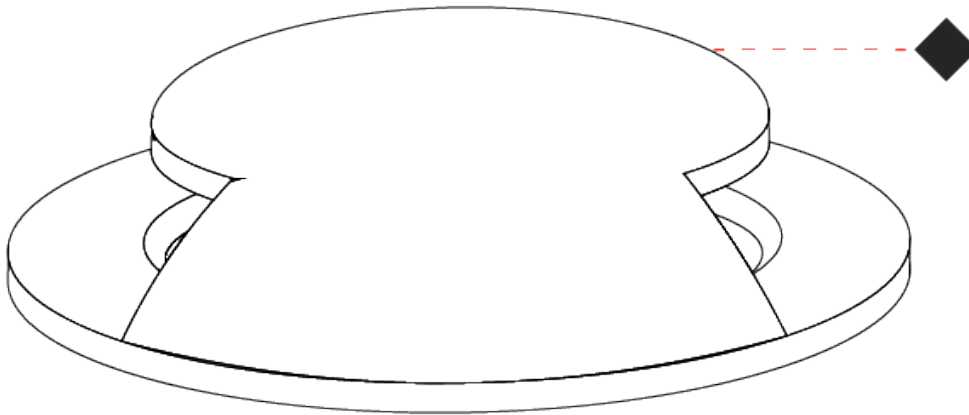

E



## MEDIO RECESSED

### E91478- -

base number Color Lens  
 Temperature Options

- To build a product code in our configurator select the specify button on the base model # product page
- To build a manual product code on this datasheet choose from the options listed below in blue font and add the suffix to the base model #

#### GENERAL

Series: Medio  
 Subseries: Medio  
 Brand: Platek  
 Division: Exterior  
 Mounting Type: Recessed  
 Mounting Location: In-Ground  
 Subcategory: Drive Over

#### PHYSICAL

Shape: Round  
 Diameter (mm): 206  
 Diameter (in): 8 1/8  
 Height (mm): 230  
 Height (in): 9 1/16  
 Light Distribution: Uplight  
 Weight (kg): 3.5  
 Weight (lbs): 7.72  
 Load Resistance (kg): 2000  
 Load Resistance (lbs): 4409  
 Installation Requirement: Installation in sleeve set in concrete with a 20-30 cm gravel drain bed  
 Screws: A4 stainless steel  
 Diffuser: Flat Tempered Glass - 12mm / 15/32"  
 Fixture Finish: BLK  
 Fixture Material: Aluminum Die Cast

#### ELECTRICAL

Lamp Type: LED  
 Input Wattage (W): 27  
 Total Output Wattage (W): 24  
 Dimming: Non-Dimming / Phase Dimming (120vac Only)  
 Driver Included: Yes  
 Driver Location: Integrated  
 Driver Type: Constant Current - Universal  
 Driver Class: Class 2  
 Input Voltage (V): 120 - 277  
 Constant Current (MA): 700  
 Upon Request: (Not included - see components [IP65 or higher enclosure to be supplied by others]) Remote: 0-10Vdc dimming

#### LED

Number of LEDs: 1  
 Color Temperature (°K): 3000 / 4000  
 Max. Delivered Lumen (lm): 3090 / 3130 - 3215 / 3255  
 CRI: >80 CRI  
 Lamp Life (hrs): 60000

#### OPTICAL

Optic°: 18 / 44

#### RATINGS AND CERTIFICATIONS

Certified By: Certified for North American Standards  
 IP rating: IP68  
 IK Rating: IK10  
 Upon Request: Higher Maximum Ambient Temperature



Ø214mm 8 7/16"

Ø153mm 6"

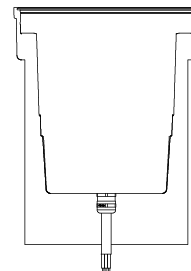
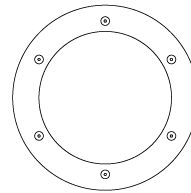

230mm 9 1/16"

260mm 10 1/4"



## MEDIO RECESSED

E9I478-

PROJECT	_____
TYPE	_____
SPECIFIER	_____
QUANTITY	_____
DATE	_____

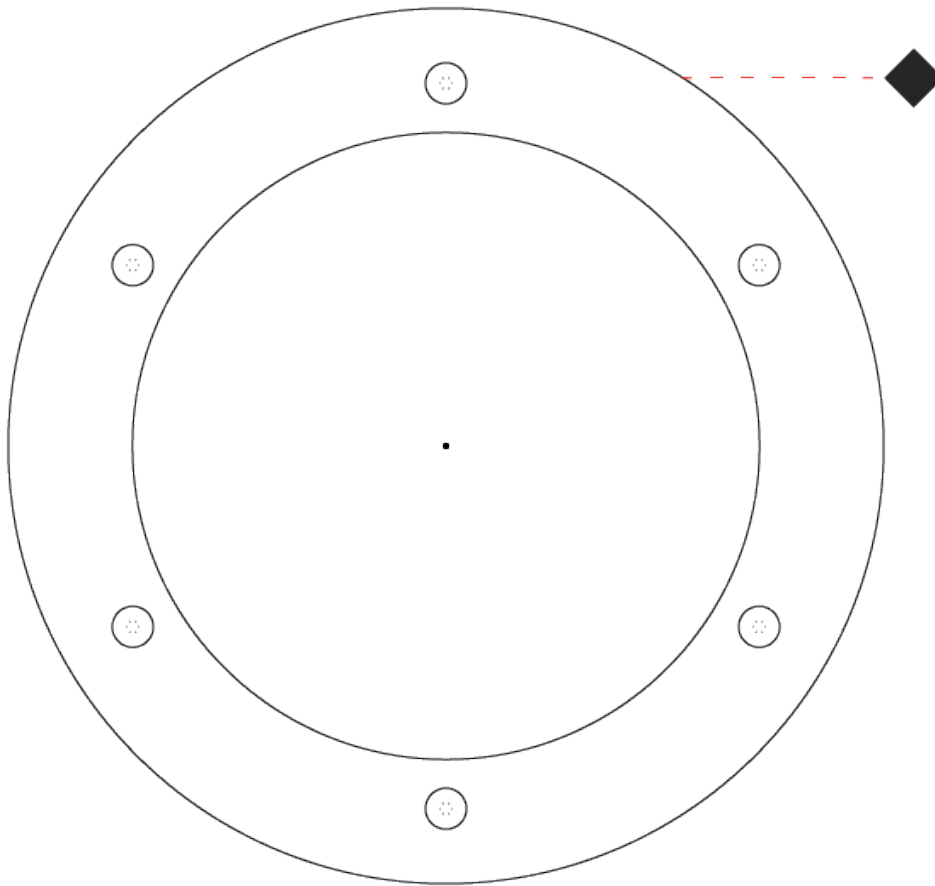

PROJECT	_____
TYPE	_____
SPECIFIER	_____
QUANTITY	_____
DATE	_____

## MEDIO SS RECESSED

**E91486-** \_\_\_\_\_ - \_\_\_\_\_

base number    Color    Lens  
 Temperature    Options

- To build a product code in our configurator select the specify button on the base model # product page
- To build a manual product code on this datasheet choose from the options listed below in blue font and add the suffix to the base model #

### GENERAL

Series: Medio  
 Subseries: Medio SS  
 Brand: Platek  
 Division: Exterior  
 Mounting Type: Recessed  
 Mounting Location: In-Ground  
 Subcategory: Drive Over

### PHYSICAL

Shape: Round  
 Diameter (mm): 224  
 Diameter (in): 8 <sup>13</sup>/<sub>16</sub>  
 Height (mm): 230  
 Height (in): 9 <sup>1</sup>/<sub>16</sub>  
 Light Distribution: Uplight  
 Weight (kg): 3.8  
 Weight (lbs): 8.38  
 Load Resistance (kg): 2000  
 Load Resistance (lbs): 4409  
 Installation Requirement: Installation in sleeve set in concrete with a 20-30 cm gravel drain bed  
 Diffuser: Extra Clear Tempered Glass - 15 mm / 9/16" thick  
 Fixture Finish: SST  
 Fixture Material: Aluminum Die Cast

### ELECTRICAL

Lamp Type: LED  
 Input Wattage (W): 27  
 Total Output Wattage (W): 24  
 Dimming: Non-Dimming / Phase Dimming (120vac Only)  
 Driver Included: Yes  
 Driver Location: Integrated  
 Driver Type: Constant Current - Universal  
 Driver Class: Class 2  
 Input Voltage (V): 120 - 277  
 Constant Current (MA): 700  
 Upon Request: (Not included - see components [IP65 or higher enclosure to be supplied by others]) Remote: 0-10Vdc dimming

### LED

Color Temperature (°K): 3000 / 4000  
 Max. Delivered Lumen (lm): 3090 / 3130 - 3215 / 3255  
 CRI: >80 CRI  
 Lamp Life (hrs): 60000

### OPTICAL

Optic°: 18 / 44

### RATINGS AND CERTIFICATIONS

Certified By: Certified for North American Standards  
 IP rating: IP68  
 IK Rating: IK10  
 Upon Request: Higher Maximum Ambient Temperature



Ø224mm 8 <sup>13</sup>/<sub>16</sub>"

Ø153mm 6"

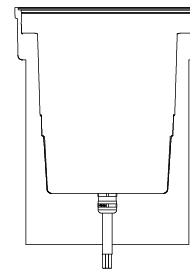
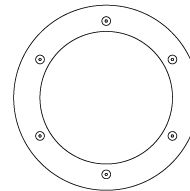

230mm 9 <sup>1</sup>/<sub>16</sub>"

260mm 10 <sup>1</sup>/<sub>4</sub>"



E9I486-

PROJECT	_____
TYPE	_____
SPECIFIER	_____
QUANTITY	_____
DATE	_____



E

PROJECT	_____
TYPE	_____
SPECIFIER	_____
QUANTITY	_____
DATE	_____

## MEDIO MARINE GRADE RECESSED

### E9I588-

base number    Color    Lens  
 Temperature    Options

- To build a product code in our configurator select the specify button on the base model # product page
- To build a manual product code on this datasheet choose from the options listed below in blue font and add the suffix to the base model #

#### GENERAL

Series: Medio  
 Subseries: Medio Marine Grade  
 Brand: Platek  
 Division: Exterior  
 Mounting Type: Recessed  
 Mounting Location: In-Ground  
 Subcategory: Drive Over

#### PHYSICAL

Shape: Round  
 Diameter (mm): 220  
 Diameter (in): 8 <sup>11</sup>/<sub>16</sub>  
 Height (mm): 113  
 Height (in): 4 <sup>7</sup>/<sub>16</sub>  
 Light Distribution: Uplight  
 Weight (kg): 3.40  
 Weight (lbs): 7.5  
 Load Resistance (kg): 1500  
 Load Resistance (lbs): 3307  
 Installation Requirement: Installation in sleeve set in concrete with a 20-30 cm gravel drain bed  
 Screws: A4 stainless steel  
 Diffuser: Clear tempered glass  
 Fixture Finish: SST  
 Fixture Material: Stainless Steel AISI 316L  
 Cable Details: Supplied with 1 power cable 1m in length

#### ELECTRICAL

Lamp Type: LED  
 Input Wattage (W): 15  
 Total Output Wattage (W): 14  
 Driver Included: No  
 Driver Location: Remote  
 Driver Type: Constant Voltage - 120 / 277Vac  
 Driver Class: Class 2  
 Input Voltage (V): 120 - 277  
 Output Voltage (V): 24  
 Upon Request: (Not included - see components [IP65 or higher enclosure to be supplied by others]) 0-10Vdc dimming / Phase dimming / Non-dimming 120/277Vac

#### LED

Number of LEDs: 9  
 Color Temperature (°K): 3000 / 4000  
 Max. Delivered Lumen (lm): 1480 / 1540  
 Nominal Lumen (lm): 1710 / 1800  
 CRI: >80 CRI  
 Lamp Life (hrs): 60000

#### OPTICAL

Optic: 9 / 28 / 45 / ELL

#### RATINGS AND CERTIFICATIONS

Certified By: Certified for North American Standards  
 IP rating: IP68  
 IK Rating: IK10  
 Marine Grade: Stainless Steel AISI 316L  
 Upon Request: Higher Maximum Ambient Temperature



220mm 8 <sup>11</sup>/<sub>16</sub>"

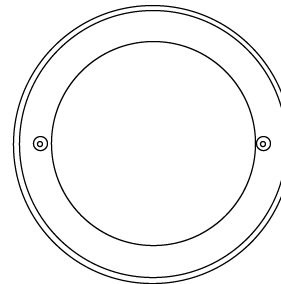

196mm 7 <sup>11</sup>/<sub>16</sub>"

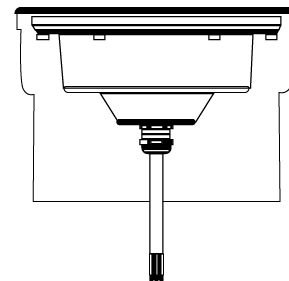

113mm 4 <sup>7</sup>/<sub>16</sub>"  
 140mm 5 <sup>1</sup>/<sub>2</sub>"



## MEDIO MARINE GRADE RECESSED

E9I588-

PROJECT

TYPE

SPECIFIER

QUANTITY

DATE



## MEDIO RECESSED

### E91627-

base number Lens  
Options

- To build a product code in our configurator select the specify button on the base model # product page
- To build a manual product code on this datasheet choose from the options listed below in blue font and add the suffix to the base model #

#### GENERAL

Series: Medio  
Subseries: Medio  
Brand: Platek  
Division: Exterior  
Mounting Type: Recessed  
Mounting Location: In-Ground  
Subcategory: Drive Over

#### PHYSICAL

Shape: Round  
Diameter (mm): 206  
Height (mm): 230  
Height (in): 9 1/16  
Light Distribution: Uplight  
Weight (kg): 3.3  
Weight (lbs): 7.3  
Load Resistance (kg): 2000  
Load Resistance (lbs): 4409  
Installation Requirement: Installation in sleeve set in concrete with a 20-30 cm gravel drain bed  
Screws: A4 stainless steel  
Diffuser: Clear tempered glass  
Fixture Finish: BLK  
Fixture Material: Aluminum Die Cast  
Cable Details: Supplied with 1 power cable 1.5m in length

#### ELECTRICAL

Lamp Type: LED  
Input Wattage (W): 16  
Total Output Wattage (W): 16  
Dimming: Bluetooth technology or DMX  
Control Gear: DMX  
Driver Included: No  
Driver Location: Remote  
Driver Type: Constant Current - Universal  
Driver Class: Class 2  
Input Voltage (V): 120 - 277  
Constant Current (MA): 350

#### LED

Number of LEDs: 16  
Color Temperature (°K): RGBW  
CRI: >80 CRI  
Efficiency (%): 99.4  
Lamp Life (hrs): 60000  
Special LEDs offerings: RGBW

#### OPTICAL

Optic°: 9 / 28 / 44

#### RATINGS AND CERTIFICATIONS

Certified By: Certified for North American Standards  
IP rating: IP68  
IK Rating: IK10  
Upon Request: Higher Maximum Ambient Temperature

PROJECT	
TYPE	
SPECIFIER	
QUANTITY	
DATE	



Ø214mm 8 7/16"

Ø153mm 6"

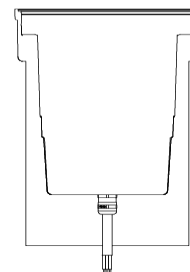
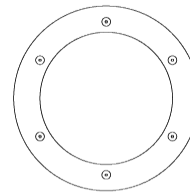

230mm 9 1/16"

260mm 10 1/4"



E9I627-

PROJECT	_____
TYPE	_____
SPECIFIER	_____
QUANTITY	_____
DATE	_____

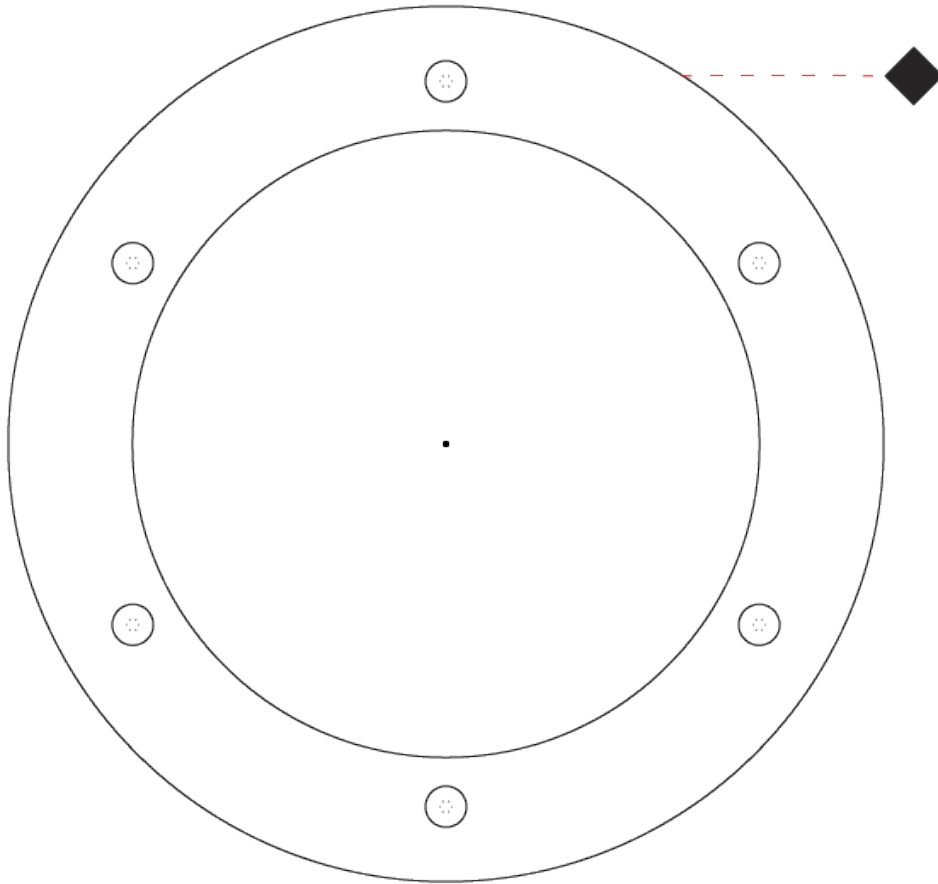



## MEDIO MARINE GRADE RECESSED

### E91629-

base number Lens  
Options

- To build a product code in our configurator select the specify button on the base model # product page
- To build a manual product code on this datasheet choose from the options listed below in blue font and add the suffix to the base model #

#### GENERAL

Series: Medio  
Subseries: Medio Marine Grade  
Brand: Platek  
Division: Exterior  
Mounting Type: Recessed  
Mounting Location: In-Ground  
Subcategory: Drive Over

#### PHYSICAL

Shape: Round  
Diameter (mm): 220  
Diameter (in): 8 <sup>11</sup>/<sub>16</sub>  
Height (mm): 113  
Height (in): 4 <sup>7</sup>/<sub>16</sub>  
Light Distribution: Uplight  
Weight (kg): 3.40  
Weight (lbs): 7.5  
Load Resistance (kg): 1500  
Load Resistance (lbs): 3307  
Installation Requirement: Installation in sleeve set in concrete with a 20-30 cm gravel drain bed  
Screws: A4 stainless steel  
Diffuser: Clear tempered glass  
Fixture Finish: SST  
Fixture Material: Stainless Steel AISI 316L  
Cable Details: Supplied with 1 power cable 1m in length

#### ELECTRICAL

Lamp Type: LED  
Input Wattage (W): 16  
Total Output Wattage (W): 16  
Dimming: Bluetooth technology or DMX  
Control Gear: DMX  
Driver Included: No  
Driver Location: Remote  
Driver Type: Constant Current - Universal  
Driver Class: Class 2  
Input Voltage (V): 120 - 277  
Constant Current (MA): 350

#### LED

Number of LEDs: 16  
Color Temperature (°K): RGBW  
CRI: >80 CRI  
Lamp Life (hrs): 60000  
Special LEDs offerings: RGBW

#### OPTICAL

Optic: 9 / 28 / 45 / ELL

#### RATINGS AND CERTIFICATIONS

Certified By: Certified for North American Standards  
IP rating: IP68  
IK Rating: IK10  
Marine Grade: Stainless Steel AISI 316L  
Upon Request: Higher Maximum Ambient Temperature

PROJECT	
TYPE	
SPECIFIER	
QUANTITY	
DATE	



220mm 8 <sup>11</sup>/<sub>16</sub>"

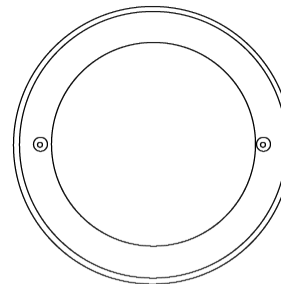

196mm 7 <sup>11</sup>/<sub>16</sub>"

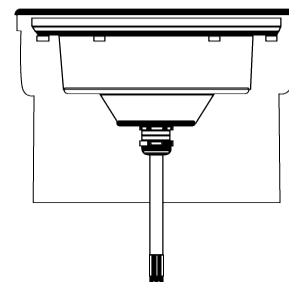

113mm 4 <sup>7</sup>/<sub>16</sub>"  
140mm 5 <sup>1</sup>/<sub>2</sub>"



## MEDIO MARINE GRADE RECESSED

E9I629-

PROJECT

TYPE

SPECIFIER

QUANTITY

DATE



## MEDIO COLOR FINISH CHART

PROJECT	_____
TYPE	_____
SPECIFIER	_____
QUANTITY	_____
DATE	_____

### Fixture Finish

Black - BLK



Stainless Steel Inox - SST

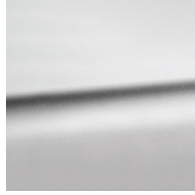

White - WHI

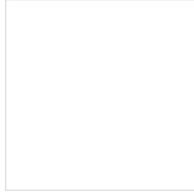

Gray - GRY

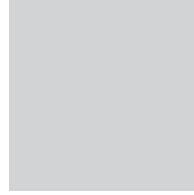

Corten - COR



Anthracite - ANT

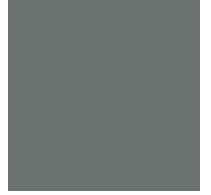

Bronze - BRZ



**Digital:** Not all screens are calibrated the same, and therefore, colors will appear differently between screens.











**Physical:** When texture is involved, there will be variations in color, character and tone within a product series and between product families.



### LEGEND

 floor-mounted	 pivotable	 special LED (upon request) RGB, RGBW, tunable, gold+, meat+, art+, fashion+
 wall and ceiling: recessed and surface mounted	 rotating	 warm dim / natural dimming LED
 ceiling-mounted and wall-mounted	 illuminate tilted	 rechargeable battery powered
 wall-mounted	 color of suspension cable	 fixture with natural vivid LED (upon request)
 omni-directional light distribution	 length of suspension cable	 color rendering index
 direct light distribution	 reflector degree selection	 color temperature
 direct/indirect light distribution	 super spot	 lumen (luminous flux)
 indirect light distribution	 lens	 efficacy (lumens per watt)
 asymmetric light distribution	 lens pack	 Unified Glare Rating (UGR) range from 5-40
 aura light distribution	 shine ring	 marine grade (AISI 316 stainless steel)
 round wall or ceiling cut-out	 integrated shine ring with diffuser	 walk on
 square wall or ceiling cut-out	 free individual colors 01-29	 drive on
 the supplied jig specifies the cutout dimensions	 individual colors: 00 (free of charge), 01-25 (extra charge)	 Dark Sky Compliance
 minimum distance (meters) lamp - object	 luminaire part to be colored (F1)	 Americans with Disabilities Act (less than 4" off the wall located between 27"-84" from floor)
 recessed depth	 luminaire part to be colored (F2)	 lamp protected against explosion
 ceiling thickness in mm	 luminaire part to be colored (F3)	 blown glass using traditional methods by master glass blower
 ceiling thickness selection	 luminaire part to be colored (F4)	 acoustic material
 dimmable DP (phase), DV (0-10V), DD (dali), DS (step-dim)	 luminaire part to be colored (F5)	 protection class I, protection insulation
 included or excluded LED driver/transformer/control gear	 color of 3-circuit adaptor	 protection class II, protection insulation
 separately switchable	 indirect diffuser	 ETL Certified to UL and CSA Standards
 sensor	 direct diffuser	 UL Certified to UL and CSA Standards
 remote control	 ball-proof (upon request)	 CSA Certified to UL and CSA Standards
 available upon request	 accessory	 Certified for North American Standards

### IP RATING

 IP20	protected against ingress of solid bodies greater than 12.5mm (finger)
 IP33	protected against ingress of solid bodies greater than 2.5mm protected against sprays of water up to 60 degrees from the vertical (rain)
 IP40	protected against ingress of solid bodies greater than 1mm (wire) no protection against the ingress of moisture
 IP43	protected against ingress of solid bodies greater than 1mm (wire) protected against sprays of water up to 60 degrees from the vertical (rain)
 IP44	protected against ingress of solid bodies greater than 1mm (wire) protected against water splashed from all directions
 IP54	protected against limited ingress of dust (wet rooms/covered outdoor areas) protected against water splashed from all directions
 IP65	protected against ingress of dust protected against jets of water
 IP66	protected against ingress of dust protected against powerful jets of water or heavy seas
 IP67	protected against ingress of dust protected against immersion of water between 15cm - 1m for 30 minutes
 IP68	protected against ingress of dust protected against immersion of water under pressure for long periods

### IK RATING

 IK01	protected against 0.14 joules impact (equivalent to 0.25kg mass dropped from 56mm above the surface)
 IK02	protected against 0.2 joules impact (equivalent to 0.25kg mass dropped from 80mm above the surface)
 IK03	protected against 0.35 joules impact (equivalent to 0.25kg mass dropped from 140mm above the surface)
 IK04	protected against 0.5 joules impact (equivalent to 0.25kg mass dropped from 200mm above the surface)
 IK05	protected against 0.7 joules impact (equivalent to 0.25kg mass dropped from 280mm above the surface)
 IK06	protected against 1 joules impact (equivalent to 0.25kg mass dropped from 400mm above the surface)
 IK07	protected against 2 joules impact (equivalent to 0.5kg mass dropped from 400mm above the surface)
 IK08	protected against 5 joules impact (equivalent to 1.7kg mass dropped from 300mm above the surface)
 IK09	protected against 10 joules impact (equivalent to 5.0kg mass dropped from 200mm above the surface)
 IK10	protected against 20 joules impact (equivalent to 5.0kg mass dropped from 400mm above the surface)