

STANDARD MENHIR POST

E9B057- -

base number Color Finish
 Temperature Options

- To build a product code in our configurator select the specify button on the base model # product page
- To build a manual product code on this datasheet choose from the options listed below in blue font and add the suffix to the base model #

GENERAL

Series: Menhir
 Subseries: Standard Menhir
 Brand: Platek
 Division: Exterior
 Mounting Type: Post
 Mounting Location: Above Ground
 Subcategory: Bollard

PHYSICAL

Shape: Cylinder
 Diameter (mm): 200
 Diameter (in): 7 7/8
 Height (mm): 620
 Height (in): 24 7/16
 Light Distribution: Direct
 Screws: A4 stainless steel
 Diffuser: Clear tempered glass
 Fixture Finish: [BLK / WHI / GRY / COR / ANT / BRZ](#)
 Fixture Material: Aluminum
 Cable Details: 8-13mm cable allowed

ELECTRICAL

Lamp Type: LED
 Input Wattage (W): 20
 Total Output Wattage (W): 18
 Dimming: Non-Dimming / Phase Dimming (120vac Only)
 Driver Included: Yes
 Driver Location: Integrated
 Driver Type: Constant Current - Universal
 Driver Class: Class 2
 Input Voltage (V): 120 - 277
 Constant Current (MA): 500
 Upon Request: (Not included - see components [IP65 or higher enclosure to be supplied by others]): Remote: 0-10Vdc dimming

LED

Color Temperature (°K): [3000 / 4000](#)
 Max. Delivered Lumen (lm): 1240 / 1290
 Nominal Lumen (lm): 2400 / 2495
 CRI: >80 CRI
 Lamp Life (hrs): 60000

OPTICAL

Optic°: 2 Openings

RATINGS AND CERTIFICATIONS

Certified By: Certified for North American Standards
 IP rating: IP65
 IK Rating: IK08
 Bug Rating: B1 U3 G1
 Upon Request: Higher Maximum Ambient Temperature

PROJECT
TYPE
SPECIFIER
QUANTITY
DATE

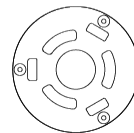
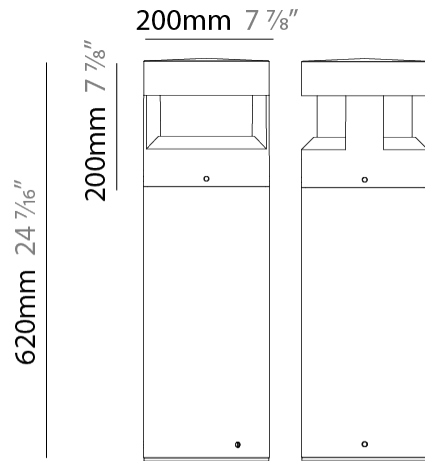

200mm 7 7/8"



STANDARD MENHIR POST

E9B057-

PROJECT

TYPE

SPECIFIER

QUANTITY

DATE



E

STANDARD MENHIR POST

E9B063-

base number Color Finish
 Temperature Options

- To build a product code in our configurator select the specify button on the base model # product page
- To build a manual product code on this datasheet choose from the options listed below in blue font and add the suffix to the base model #

GENERAL

Series: Menhir
 Subseries: Standard Menhir
 Brand: Platek
 Division: Exterior
 Mounting Type: Post
 Mounting Location: Above Ground
 Subcategory: Bollard

PHYSICAL

Shape: Cylinder
 Diameter (mm): 200
 Diameter (in): 7 7/8
 Height (mm): 1050
 Height (in): 41 5/16
 Light Distribution: Direct
 Screws: A4 stainless steel
 Diffuser: Clear tempered glass
 Fixture Finish: BLK / WHI / GRY / COR / ANT / BRZ
 Fixture Material: Aluminum
 Cable Details: 8-13mm cable allowed

ELECTRICAL

Lamp Type: LED
 Input Wattage (W): 40
 Total Output Wattage (W): 36
 Dimming: Non-Dimming / Phase Dimming (120vac Only)
 Driver Included: Yes
 Driver Location: Integrated
 Driver Type: Constant Current - Universal
 Driver Class: Class 2
 Input Voltage (V): 120 - 277
 Constant Current (MA): 1050
 Upon Request: (Not included - see components [IP65 or higher enclosure to be supplied by others]): Remote: 0-10Vdc dimming

LED

Color Temperature (°K): 3000 / 4000
 Max. Delivered Lumen (lm): 2500 / 2600
 Nominal Lumen (lm): 4355 / 4530
 CRI: >80 CRI
 Lamp Life (hrs): 60000

OPTICAL

Optic°: 2 Openings

RATINGS AND CERTIFICATIONS

Certified By: Certified for North American Standards
 IP rating: IP65
 IK Rating: IK08
 Bug Rating: B1 U3 G2
 Upon Request: Higher Maximum Ambient Temperature

PROJECT
TYPE
SPECIFIER
QUANTITY
DATE



STANDARD MENHIR POST

E9B063-

PROJECT _____

TYPE _____

SPECIFIER _____

QUANTITY _____

DATE _____



MICRO MENHIR POST

E9B167-

base number
 Color Finish
 Temperature Options

- To build a product code in our configurator select the specify button on the base model # product page
- To build a manual product code on this datasheet choose from the options listed below in blue font and add the suffix to the base model #

GENERAL

Series: Menhir
 Subseries: Micro Menhir
 Brand: Platek
 Division: Exterior
 Mounting Type: Post
 Mounting Location: Above Ground
 Subcategory: Bollard

PHYSICAL

Shape: Cylinder
 Diameter (mm): 115
 Diameter (in): 4 1/2
 Height (mm): 500
 Height (in): 19 11/16
 Light Distribution: Direct
 Screws: A4 stainless steel
 Diffuser: Transparent Methacrylate
 Fixture Finish: [BLK](#) / [WHI](#) / [GRY](#) / [COR](#) / [ANT](#) / [BRZ](#)
 Fixture Material: Aluminum

ELECTRICAL

Lamp Type: LED
 Input Wattage (W): 16
 Total Output Wattage (W): 15
 Dimming: Electronic Low Voltage Dimming
 Input Voltage (V): 120Vac Direct Line

LED

[Color Temperature \(°K\): 3000 / 4000](#)
 Max. Delivered Lumen (lm): 340 / 355
 Nominal Lumen (lm): 1350 / 1405
 CRI: >80 CRI
 Lamp Life (hrs): 60000

OPTICAL

Optic°: 1 Opening

RATINGS AND CERTIFICATIONS

Certified By: Certified for North American Standards
 IP rating: IP65
 IK Rating: IK10
 Bug Rating: B1 U0 G1
 Upon Request: Higher Maximum Ambient Temperature

PROJECT
TYPE
SPECIFIER
QUANTITY
DATE



MICRO MENHIR POST

E9B167-

PROJECT

TYPE

SPECIFIER

QUANTITY

DATE



MICRO MENHIR POST

E9B168-

base number
 Color Finish
 Temperature Options

- To build a product code in our configurator select the specify button on the base model # product page
- To build a manual product code on this datasheet choose from the options listed below in blue font and add the suffix to the base model #

GENERAL

Series: Menhir
 Subseries: Micro Menhir
 Brand: Platek
 Division: Exterior
 Mounting Type: Post
 Mounting Location: Above Ground
 Subcategory: Bollard

PHYSICAL

Shape: Cylinder
 Diameter (mm): 115
 Diameter (in): 4 1/2
 Height (mm): 500
 Height (in): 19 11/16
 Light Distribution: Direct
 Screws: A4 stainless steel
 Diffuser: Transparent Methacrylate
 Fixture Finish: [BLK](#) / [WHI](#) / [GRY](#) / [COR](#) / [ANT](#) / [BRZ](#)
 Fixture Material: Aluminum

ELECTRICAL

Lamp Type: LED
 Input Wattage (W): 16
 Total Output Wattage (W): 15
 Dimming: Electronic Low Voltage Dimming
 Input Voltage (V): 120Vac Direct Line

LED

[Color Temperature \(°K\): 3000 / 4000](#)
 Max. Delivered Lumen (lm): 665 / 690
 Nominal Lumen (lm): 1350 / 1405
 CRI: >80 CRI
 Lamp Life (hrs): 60000

OPTICAL

Optic°: 2 Openings

RATINGS AND CERTIFICATIONS

Certified By: Certified for North American Standards
 IP rating: IP65
 IK Rating: IK10
 Upon Request: Higher Maximum Ambient Temperature

PROJECT
TYPE
SPECIFIER
QUANTITY
DATE



115mm 4 1/2"

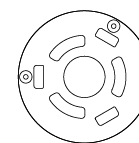
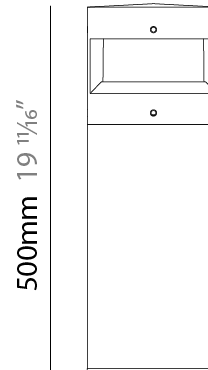

115mm 4 1/2"



MICRO MENHIR POST

E9B168-

PROJECT

TYPE

SPECIFIER

QUANTITY

DATE

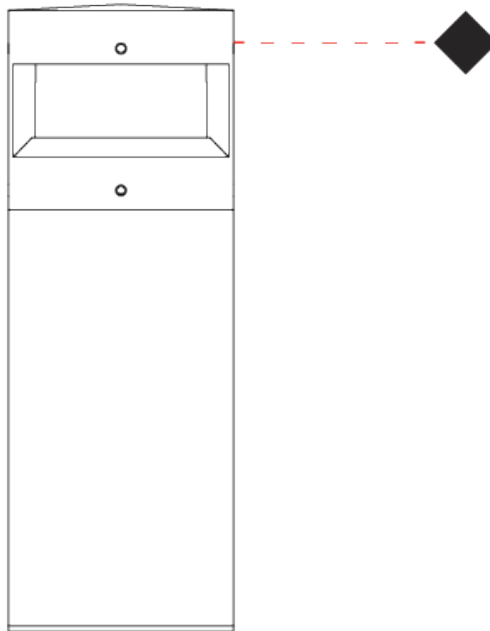

MICRO MENHIR POST

E9B171- -

base number
 Color Finish
 Temperature Options

- To build a product code in our configurator select the specify button on the base model # product page
- To build a manual product code on this datasheet choose from the options listed below in blue font and add the suffix to the base model #

GENERAL

Series: Menhir
 Subseries: Micro Menhir
 Brand: Platek
 Division: Exterior
 Mounting Type: Post
 Mounting Location: Above Ground
 Subcategory: Bollard

PHYSICAL

Shape: Cylinder
 Diameter (mm): 115
 Diameter (in): 4 ½
 Height (mm): 800
 Height (in): 31 ½
 Light Distribution: Direct
 Screws: A4 stainless steel
 Diffuser: Transparent Methacrylate
 Fixture Finish: [BLK](#) / [WHI](#) / [GRY](#) / [COR](#) / [ANT](#) / [BRZ](#)
 Fixture Material: Aluminum

ELECTRICAL

Lamp Type: LED
 Input Wattage (W): 16
 Total Output Wattage (W): 15
 Dimming: Electronic Low Voltage Dimming
 Input Voltage (V): 120Vac Direct Line

LED

[Color Temperature \(°K\): 3000 / 4000](#)
 Max. Delivered Lumen (lm): 340 / 355
 Nominal Lumen (lm): 1350 / 1405
 CRI: >80 CRI
 Lamp Life (hrs): 60000

OPTICAL

Optic°: 1 Opening

RATINGS AND CERTIFICATIONS

Certified By: Certified for North American Standards
 IP rating: IP65
 IK Rating: IK10
 Upon Request: Higher Maximum Ambient Temperature

PROJECT
TYPE
SPECIFIER
QUANTITY
DATE

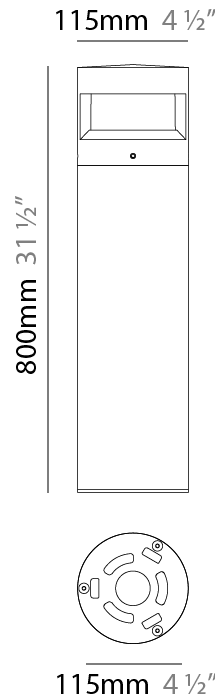

MICRO MENHIR POST

E9B171-

PROJECT

TYPE

SPECIFIER

QUANTITY

DATE



MICRO MENHIR POST

E9B172- -

base number
 Color Finish
 Temperature Options

- To build a product code in our configurator select the specify button on the base model # product page
- To build a manual product code on this datasheet choose from the options listed below in blue font and add the suffix to the base model #

GENERAL

Series: Menhir
 Subseries: Micro Menhir
 Brand: Platek
 Division: Exterior
 Mounting Type: Post
 Mounting Location: Above Ground
 Subcategory: Bollard

PHYSICAL

Shape: Cylinder
 Diameter (mm): 115
 Diameter (in): 4 ½
 Height (mm): 800
 Height (in): 31 ½
 Light Distribution: Direct
 Screws: A4 stainless steel
 Diffuser: Transparent Methacrylate
 Fixture Finish: [BLK](#) / [WHI](#) / [GRY](#) / [COR](#) / [ANT](#) / [BRZ](#)
 Fixture Material: Aluminum

ELECTRICAL

Lamp Type: LED
 Input Wattage (W): 16
 Total Output Wattage (W): 15
 Dimming: Electronic Low Voltage Dimming
 Input Voltage (V): 120Vac Direct Line

LED

Color Temperature (°K): [3000](#) / [4000](#)
 Max. Delivered Lumen (lm): 665 / 690
 Nominal Lumen (lm): 1350 / 1405
 CRI: >80 CRI
 Lamp Life (hrs): 60000

OPTICAL

Optic°: 2 Openings

RATINGS AND CERTIFICATIONS

Certified By: Certified for North American Standards
 IP rating: IP65
 IK Rating: IK10
 Upon Request: Higher Maximum Ambient Temperature

PROJECT
TYPE
SPECIFIER
QUANTITY
DATE



MICRO MENHIR POST

E9B172-

PROJECT

TYPE

SPECIFIER

QUANTITY

DATE



STANDARD MENHIR POST

E9B260-

base number
 Color Finish
 Temperature Options

- To build a product code in our configurator select the specify button on the base model # product page
- To build a manual product code on this datasheet choose from the options listed below in blue font and add the suffix to the base model #

GENERAL

Series: Menhir
 Subseries: Standard Menhir
 Brand: Platek
 Division: Exterior
 Mounting Type: Post
 Mounting Location: Above Ground
 Subcategory: Bollard

PHYSICAL

Shape: Cylinder
 Diameter (mm): 200
 Diameter (in): 7 7/8
 Height (mm): 620
 Height (in): 24 7/16
 Light Distribution: Direct
 Weight (kg): 8.3
 Weight (lbs): 18.3
 Screws: A4 stainless steel
 Diffuser: Clear tempered glass
 Fixture Finish: [BLK](#) / [WHI](#) / [GRY](#) / [COR](#) / [ANT](#) / [BRZ](#)
 Fixture Material: Aluminum
 Cable Details: 8-13mm cable allowed

ELECTRICAL

Lamp Type: LED
 Input Wattage (W): 20.3
 Total Output Wattage (W): 18
 Dimming: Non-Dimming / Phase Dimming (120vac Only)
 Driver Included: Yes
 Driver Location: Integrated
 Driver Type: Constant Current - Universal
 Driver Class: Class 2
 Input Voltage (V): 120 - 277
 Constant Current (MA): 500
 Upon Request: (Not included - see components [IP65 or higher enclosure to be supplied by others]) Remote: 0-10Vdc dimming

LED

Number of LEDs: 1
 Color Temperature (°K): [3000](#) / [4000](#)
 Max. Delivered Lumen (lm): 775 / 805
 Nominal Lumen (lm): 2400 / 2495
 CRI: >80 CRI
 Lamp Life (hrs): 60000

OPTICAL

Optic°: 2 Openings

RATINGS AND CERTIFICATIONS

Certified By: Certified for North American Standards
 IP rating: IP65
 IK Rating: IK08
 Upon Request: Higher Maximum Ambient Temperature

PROJECT _____
 TYPE _____
 SPECIFIER _____
 QUANTITY _____
 DATE _____



200mm 7 7/8"



STANDARD MENHIR POST

E9B260-

PROJECT _____

TYPE _____

SPECIFIER _____

QUANTITY _____

DATE _____



STANDARD MENHIR POST

E9B262-

base number Color Finish
 Temperature Options

- To build a product code in our configurator select the specify button on the base model # product page
- To build a manual product code on this datasheet choose from the options listed below in blue font and add the suffix to the base model #

GENERAL

Series: Menhir
 Subseries: Standard Menhir
 Brand: Platek
 Division: Exterior
 Mounting Type: Post
 Mounting Location: Above Ground
 Subcategory: Bollard

PHYSICAL

Shape: Cylinder
 Diameter (mm): 200
 Diameter (in): 7 7/8
 Height (mm): 1050
 Height (in): 41 5/16
 Light Distribution: Direct
 Weight (kg): 8.3
 Weight (lbs): 18.3
 Screws: A4 stainless steel
 Diffuser: Clear tempered glass
 Fixture Finish: [BLK](#) / [WHI](#) / [GRY](#) / [COR](#) / [ANT](#) / [BRZ](#)
 Fixture Material: Aluminum
 Cable Details: 8-13mm cable allowed

ELECTRICAL

Lamp Type: LED
 Input Wattage (W): 40
 Total Output Wattage (W): 36
 Dimming: Non-Dimming / Phase Dimming (120vac Only)
 Driver Included: Yes
 Driver Location: Integrated
 Driver Type: Constant Current - Universal
 Driver Class: Class 2
 Input Voltage (V): 120 - 277
 Constant Current (MA): 1050
 Upon Request: (Not included - see components [IP65 or higher enclosure to be supplied by others]) Remote: 0-10Vdc dimming

LED

Number of LEDs: 1
 Color Temperature (°K): [3000](#) / [4000](#)
 Max. Delivered Lumen (lm): 1430 / 1490
 Nominal Lumen (lm): 4355 / 4530
 CRI: >80 CRI
 Lamp Life (hrs): 60000

OPTICAL

Optic°: 1 Opening

RATINGS AND CERTIFICATIONS

Certified By: Certified for North American Standards
 IP rating: IP65
 IK Rating: IK08
 Upon Request: Higher Maximum Ambient Temperature

PROJECT
TYPE
SPECIFIER
QUANTITY
DATE



STANDARD MENHIR POST

E9B262-

PROJECT _____

TYPE _____

SPECIFIER _____

QUANTITY _____

DATE _____



E

PROJECT _____

TYPE _____

SPECIFIER _____

QUANTITY _____

DATE _____

Fixture Finish

Black - BLK



White - WHI

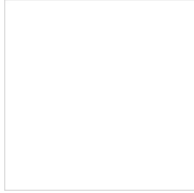

Gray - GRY



Corten - COR



Anthracite - ANT



Bronze - BRZ



Digital: Not all screens are calibrated the same, and therefore, colors will appear differently between screens.

Physical: When texture is involved, there will be variations in color, character and tone within a product series and between product families.



PROJECT	
TYPE	
SPECIFIER	
QUANTITY	
DATE	

LEGEND

	floor-mounted		pivotable		special LED (upon request) RGB, RGBW, tunable, gold+, meat+, art+, fashion+
	wall and ceiling: recessed and surface mounted		rotating		warm dim / natural dimming LED
	ceiling-mounted and wall-mounted		illuminate tilted		rechargeable battery powered
	wall-mounted		color of suspension cable		fixture with natural vivid LED (upon request)
	omni-directional light distribution		length of suspension cable		color rendering index
	direct light distribution		reflector degree selection		color temperature
	direct/indirect light distribution		super spot		lumen (luminous flux)
	indirect light distribution		lens		efficacy (lumens per watt)
	asymmetric light distribution		lens pack		Unified Glare Rating (UGR) range from 5-40
	aura light distribution		shine ring		marine grade (AISI 316 stainless steel)
	round wall or ceiling cut-out		integrated shine ring with diffuser		walk on
	square wall or ceiling cut-out		free individual colors 01-29		drive on
	the supplied jig specifies the cutout dimensions		individual colors: 00 (free of charge), 01-25 (extra charge)		Dark Sky Compliance
	minimum distance (meters) lamp - object		luminaire part to be colored (F1)		Americans with Disabilities Act (less than 4" off the wall located between 27"-84" from floor)
	recessed depth		luminaire part to be colored (F2)		lamp protected against explosion
	ceiling thickness in mm		luminaire part to be colored (F3)		blown glass using traditional methods by master glass blower
	ceiling thickness selection		luminaire part to be colored (F4)		acoustic material
	dimmable DP (phase), DV (0-10V), DD (dali), DS (step-dim)		luminaire part to be colored (F5)		protection class I, protection insulation
	included or excluded LED driver/transformer/control gear		color of 3-circuit adaptor		protection class II, protection insulation
	separately switchable		indirect diffuser		ETL Certified to UL and CSA Standards
	sensor		direct diffuser		UL Certified to UL and CSA Standards
	remote control		ball-proof (upon request)		CSA Certified to UL and CSA Standards
	available upon request		accessory		Certified for North American Standards

IP RATING

	protected against ingress of solid bodies greater than 12.5mm (finger)
	protected against ingress of solid bodies greater than 2.5mm protected against sprays of water up to 60 degrees from the vertical (rain)
	protected against ingress of solid bodies greater than 1mm (wire) no protection against the ingress of moisture
	protected against ingress of solid bodies greater than 1mm (wire) protected against sprays of water up to 60 degrees from the vertical (rain)
	protected against ingress of solid bodies greater than 1mm (wire) protected against water splashed from all directions
	protected against limited ingress of dust (wet rooms/covered outdoor areas) protected against water splashed from all directions
	protected against ingress of dust protected against jets of water
	protected against ingress of dust protected against powerful jets of water or heavy seas
	protected against ingress of dust protected against immersion of water between 15cm - 1m for 30 minutes
	protected against ingress of dust protected against immersion of water under pressure for long periods

IK RATING

	protected against 0.14 joules impact (equivalent to 0.25kg mass dropped from 56mm above the surface)
	protected against 0.2 joules impact (equivalent to 0.25kg mass dropped from 80mm above the surface)
	protected against 0.35 joules impact (equivalent to 0.25kg mass dropped from 140mm above the surface)
	protected against 0.5 joules impact (equivalent to 0.25kg mass dropped from 200mm above the surface)
	protected against 0.7 joules impact (equivalent to 0.25kg mass dropped from 280mm above the surface)
	protected against 1 joules impact (equivalent to 0.25kg mass dropped from 400mm above the surface)
	protected against 2 joules impact (equivalent to 0.5kg mass dropped from 400mm above the surface)
	protected against 5 joules impact (equivalent to 1.7kg mass dropped from 300mm above the surface)
	protected against 10 joules impact (equivalent to 5.0kg mass dropped from 200mm above the surface)
	protected against 20 joules impact (equivalent to 5.0kg mass dropped from 400mm above the surface)