

PROJECT	
TYPE	
SPECIFIER	
QUANTITY	
DATE	

## METROPOLIS MONOPOINT SUSPENSION

### D201026-

base number	Color Temperature	Finish (Diamond)	Finish (Triangle)	Lens Options	Cable Options
-------------	----------------------	---------------------	----------------------	-----------------	------------------

- To build a product code in our configurator select the specify button on the base model # product page
- To build a manual product code on this datasheet choose from the options listed below in blue font and add the suffix to the base model #

#### GENERAL

Series: Metropolis
Subseries: Metropolis Monopoint
Brand: Zaneen
Division: Design
Mounting Type: Suspension
Mounting Location: Ceiling
Subcategory: Pendant

#### PHYSICAL

Shape: Cylinder
Diameter (mm): 25
Diameter (in): 1
Height (mm): 500
Height (in): 19 11/16
Light Distribution: Downlight
Fixture Finish: <a href="#">BLK</a> / <a href="#">BRZ</a> / <a href="#">IND</a>
Holder Finish: <a href="#">BLK</a> / <a href="#">BRZ</a> / <a href="#">IND</a>
Fixture Material: Aluminum
<a href="#">Cable Details: Black or Transparent - 3500mm / 137 13/16"</a>
Upon Request: Cylinder height. Max. 1830 mm / 72". Min 153mm / 6". Min. qty required 50 pcs.

#### ELECTRICAL

Lamp Type: LED
Input Wattage (W): 3.65
Total Output Wattage (W): 2.7
Dimming: Non-Dimmable
Driver Included: Yes
Driver Location: Integrated
Driver Type: Constant Current - Universal
Driver Class: Class 2
Input Voltage (V): 120 - 277
Constant Current (MA): 700
Upon Request: Remote: Phase dimming @120Vac only / 0-10Vdc dimming (dimming requires min. 3 fixtures)

#### LED

Number of LEDs: 1
<a href="#">Color Temperature (°K): 3000 / 4000</a>
Max. Delivered Lumen (lm): 114 / 122
Nominal Lumen (lm): 124 / 133
CRI: >90 CRI
Lamp Life (hrs): 50000
Upon Request: 3500K

#### OPTICAL

<a href="#">Optic°: 12 / 28 / 44</a>
--------------------------------------

#### RATINGS AND CERTIFICATIONS

Certified By: Certified for North American Standards
IP rating: IP41 (Damp)
Upon Request: Damp Rated for Exterior

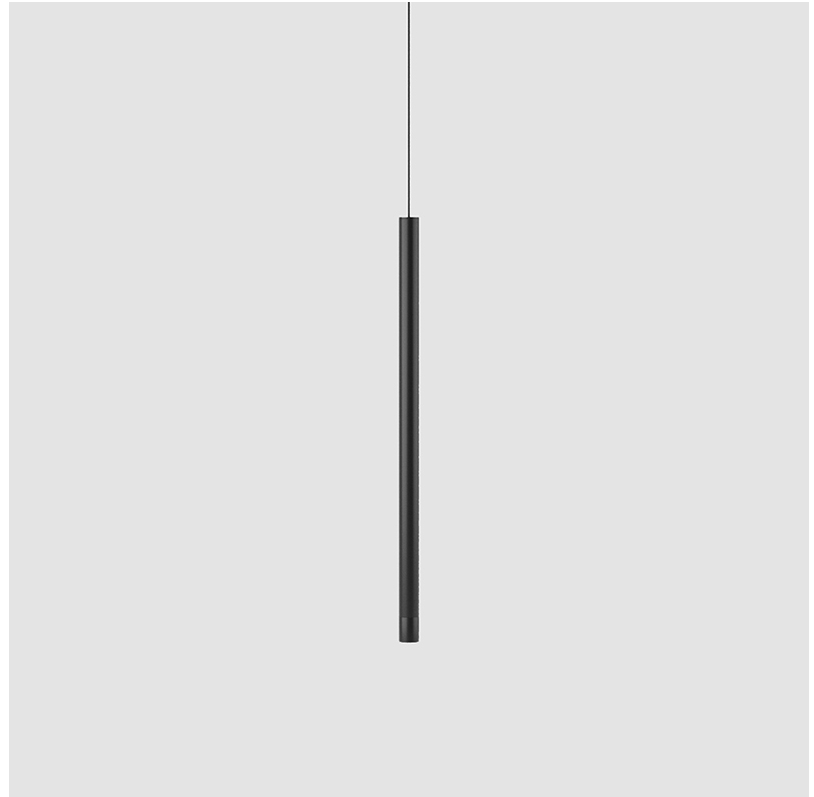

## METROPOLIS MONOPOINT SUSPENSION

D201026-

PROJECT
TYPE
SPECIFIER
QUANTITY
DATE



D

## METROPOLIS MONOPOINT SUSPENSION

### D201027-

base number    Color    Finish    Finish    Lens    Cable  
 Temperature    (Diamond)    (Triangle)    Options    Options

- To build a product code in our configurator select the specify button on the base model # product page
- To build a manual product code on this datasheet choose from the options listed below in blue font and add the suffix to the base model #

#### GENERAL

Series: Metropolis  
 Subseries: Metropolis Monopoint  
 Brand: Zaneen  
 Division: Design  
 Mounting Type: Suspension  
 Mounting Location: Ceiling  
 Subcategory: Pendant

#### PHYSICAL

Shape: Cylinder  
 Diameter (mm): 26  
 Diameter (in): 1  
 Height (mm): 800  
 Height (in): 31 1/2  
 Light Distribution: Downlight  
 Fixture Finish: [BLK / BRZ / IND](#)  
 Holder Finish: [BLK / BRZ / IND](#)  
 Fixture Material: [Aluminum](#)  
 Cable Details: [Black or Transparent - 3500mm / 137 13 /16"](#)  
 Upon Request: Cylinder height. Max. 1830 mm / 72". Min 153mm / 6".  
 Min. qty required 50 pcs.

#### ELECTRICAL

Lamp Type: LED  
 Input Wattage (W): 3.65  
 Total Output Wattage (W): 2.7  
 Dimming: Non-Dimmable  
 Driver Included: Yes  
 Driver Location: Integrated  
 Driver Type: Constant Current - Universal  
 Driver Class: Class 2  
 Input Voltage (V): 120 - 277  
 Constant Current (MA): 700  
 Upon Request: (Not included - see components) Remote: Phase dimming @120Vac only / 0-10Vdc dimming (dimming requires min. 3 fixtures)

#### LED

Number of LEDs: 1  
 Color Temperature (°K): [3000 / 4000](#)  
 Max. Delivered Lumen (lm): [114 / 122](#)  
 Nominal Lumen (lm): [124 / 133](#)  
 CRI: >90 CRI  
 Lamp Life (hrs): 50000  
 Upon Request: 3500K

#### OPTICAL

Optic°: [12 / 28 / 44](#)

#### RATINGS AND CERTIFICATIONS

Certified By: Certified for North American Standards  
 IP rating: IP41 (Damp)  
 Upon Request: Damp Rated for Exterior

PROJECT
TYPE
SPECIFIER
QUANTITY
DATE

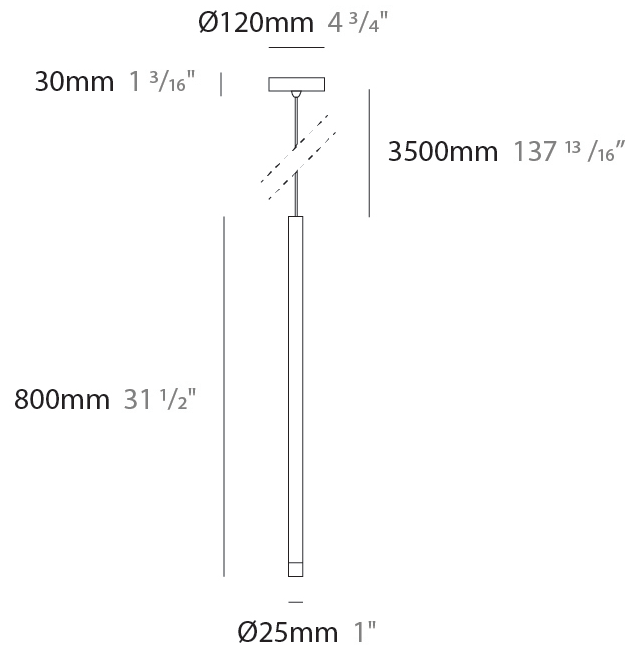

## METROPOLIS MONOPOINT SUSPENSION

D201027-

PROJECT
TYPE
SPECIFIER
QUANTITY
DATE



D

## METROPOLIS MONOPOINT HALO SUSPENSION

### D201032-

base number    Color    Finish    Finish    Lens    Cable  
 Temperature    (Diamond)    (Triangle)    Options    Options

- To build a product code in our configurator select the specify button on the base model # product page
- To build a manual product code on this datasheet choose from the options listed below in blue font and add the suffix to the base model #

#### GENERAL

Series: Metropolis  
 Subseries: Metropolis Monopoint Halo  
 Brand: Zaneen  
 Division: Design  
 Mounting Type: Suspension  
 Mounting Location: Ceiling  
 Subcategory: Pendant

#### PHYSICAL

Shape: Cylinder  
 Diameter (mm): 25  
 Diameter (in): 1  
 Height (mm): 520  
 Height (in): 20 1/2  
 Light Distribution: Downlight  
 Fixture Finish: [BLK / BRZ / IND](#)  
 Holder Finish: BLK / BRZ / IND  
 Fixture Material: Aluminum  
 Cable Details: [Black or Transparent - 3500mm / 137 13/16"](#)  
 Upon Request: Cylinder height. Max. 1830 mm / 72". Min 153mm / 6".  
 Min. qty required 50 pcs.

#### ELECTRICAL

Lamp Type: LED  
 Input Wattage (W): 3.65  
 Total Output Wattage (W): 2.7  
 Dimming: Non-Dimmable  
 Driver Included: Yes  
 Driver Location: Integrated  
 Driver Type: Constant Current - Universal  
 Driver Class: Class 2  
 Input Voltage (V): 120 - 277  
 Constant Current (MA): 700  
 Upon Request: Remote: Phase dimming @120Vac only / 0-10Vdc dimming (dimming requires min. 3 fixtures)

#### LED

Number of LEDs: 1  
 Color Temperature (°K): [3000 / 4000](#)  
 Max. Delivered Lumen (lm): 114 / 122  
 Nominal Lumen (lm): 124 / 133  
 CRI: >90 CRI  
 Lamp Life (hrs): 50000  
 Upon Request: 3500K

#### OPTICAL

Optic°: [12 / 28 / 44](#)  
 Upon Request: Damp Rated for Exterior

#### RATINGS AND CERTIFICATIONS

Certified By: Certified for North American Standards  
 IP rating: IP41 (Damp)



## METROPOLIS MONOPOINT HALO SUSPENSION

D201032-

PROJECT

TYPE

SPECIFIER

QUANTITY

DATE



D

PROJECT	
TYPE	
SPECIFIER	
QUANTITY	
DATE	

## METROPOLIS MONOPOINT HALO SUSPENSION

### D201033-

base number	Color Temperature	Finish (Diamond)	Finish (Triangle)	Lens Options	Cable Options
-------------	----------------------	---------------------	----------------------	-----------------	------------------

- To build a product code in our configurator select the specify button on the base model # product page
- To build a manual product code on this datasheet choose from the options listed below in blue font and add the suffix to the base model #

#### GENERAL

Series: Metropolis
Subseries: Metropolis Monopoint Halo
Brand: Zaneen
Division: Design
Mounting Type: Suspension
Mounting Location: Ceiling
Subcategory: Pendant

#### PHYSICAL

Shape: Cylinder
Diameter (mm): 26
Diameter (in): 1
Height (mm): 820
Height (in): 32 2/7
Light Distribution: Downlight
Fixture Finish: <a href="#">BLK</a> / <a href="#">BRZ</a> / <a href="#">IND</a>
Holder Finish: <a href="#">BLK</a> / <a href="#">BRZ</a> / <a href="#">IND</a>
Fixture Material: Aluminum
Cable Details: <a href="#">Black or Transparent - 3500mm / 137 13 / 16"</a>
Upon Request: Cylinder height. Max. 1830 mm / 72". Min 153mm / 6". Min. qty required 50 pcs.

#### ELECTRICAL

Lamp Type: LED
Input Wattage (W): 3.65
Total Output Wattage (W): 2.7
Dimming: Non-Dimmable
Driver Included: Yes
Driver Location: Integrated
Driver Type: Constant Current - Universal
Driver Class: Class 2
Input Voltage (V): 120 - 277
Constant Current (MA): 700
Upon Request: Remote: Phase dimming @120Vac only / 0-10Vdc dimming (dimming requires min. 3 fixtures)

#### LED

Number of LEDs: 1
Color Temperature (°K): <a href="#">3000</a> / <a href="#">4000</a>
Max. Delivered Lumen (lm): 114 / 122
Nominal Lumen (lm): 124 / 133
CRI: >90 CRI
Lamp Life (hrs): 50000
Upon Request: 3500K

#### OPTICAL

Optic°: <a href="#">12</a> / <a href="#">28</a> / <a href="#">44</a>
--

#### RATINGS AND CERTIFICATIONS

Certified By: Certified for North American Standards
IP rating: IP41 (Damp)
Upon Request: Damp Rated for Exterior



## METROPOLIS MONOPOINT HALO SUSPENSION

D201033-

PROJECT \_\_\_\_\_

TYPE \_\_\_\_\_

SPECIFIER \_\_\_\_\_

QUANTITY \_\_\_\_\_

DATE \_\_\_\_\_



D



## METROPOLIS MONOPOINT SURFACE

### D202000-

base number    Color    Finish    Finish    Lens  
 Temperature    (Diamond)    (Triangle)    Options

- To build a product code in our configurator select the specify button on the base model # product page
- To build a manual product code on this datasheet choose from the options listed below in blue font and add the suffix to the base model #

#### GENERAL

Series: Metropolis  
 Subseries: Metropolis Monopoint  
 Brand: Zaneen  
 Division: Design  
 Mounting Type: Surface  
 Mounting Location: Ceiling  
 Subcategory: Pendant

#### PHYSICAL

Shape: Cylinder  
 Diameter (mm): 120  
 Diameter (in): 4 ¾  
 Height (mm): 500  
 Height (in): 19 11/16  
 Light Distribution: Downlight  
 Fixture Finish: [BLK / BRZ / IND](#)  
 Holder Finish: [BLK / BRZ / IND / WHI](#)  
 Fixture Material: Aluminum  
 Upon Request: Cylinder height. Max. 1830 mm / 72". Min 153mm / 6".  
 Min. qty required 50 pcs.

#### ELECTRICAL

Lamp Type: LED  
 Input Wattage (W): 3.65  
 Total Output Wattage (W): 2.7  
 Dimming: Non-Dimmable  
 Driver Included: Yes  
 Driver Location: Integrated  
 Driver Type: Constant Current - Universal  
 Driver Class: Class 2  
 Input Voltage (V): 120 - 277  
 Constant Current (MA): 700  
 Upon Request: (Not included - see components) Remote: Phase dimming @120Vac only / 0-10Vdc dimming (dimming requires min. 3 fixtures)

#### LED

Number of LEDs: 1  
 Color Temperature (°K): [3000 / 4000](#)  
 Nominal Lumen (lm): 124 / 133  
 CRI: >90 CRI  
 Lamp Life (hrs): 50000  
 Upon Request: 3500K

#### OPTICAL

Optic°: [12 / 28 / 44](#)

#### RATINGS AND CERTIFICATIONS

Certified By: Certified for North American Standards  
 IP rating: IP41 (Damp)  
 Upon Request: Damp Rated for Exterior

PROJECT
TYPE
SPECIFIER
QUANTITY
DATE

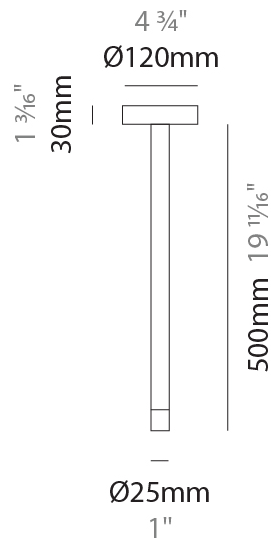

## METROPOLIS MONOPOINT SURFACE

D202000-

PROJECT

TYPE

SPECIFIER

QUANTITY

DATE



D

## METROPOLIS MONOPOINT SURFACE

### D202001-

base number    Color    Finish    Finish    Lens  
 Temperature    (Diamond)    (Triangle)    Options

- To build a product code in our configurator select the specify button on the base model # product page
- To build a manual product code on this datasheet choose from the options listed below in blue font and add the suffix to the base model #

#### GENERAL

Series: Metropolis  
 Subseries: Metropolis Monopoint  
 Brand: Zaneen  
 Division: Design  
 Mounting Type: Surface  
 Mounting Location: Ceiling  
 Subcategory: Pendant

#### PHYSICAL

Shape: Cylinder  
 Diameter (mm): 120  
 Diameter (in): 4 ¾  
 Height (mm): 800  
 Height (in): 31 ½  
 Light Distribution: Downlight  
 Fixture Finish: [BLK / BRZ / IND](#)  
 Holder Finish: [BLK / BRZ / IND / WHI](#)  
 Fixture Material: Aluminum  
 Upon Request: Cylinder height. Max. 1830 mm / 72". Min 153mm / 6".  
 Min. qty required 50 pcs.

#### ELECTRICAL

Lamp Type: LED  
 Input Wattage (W): 3.65  
 Total Output Wattage (W): 2.7  
 Dimming: Non-Dimmable  
 Driver Included: Yes  
 Driver Location: Integrated  
 Driver Type: Constant Current - Universal  
 Driver Class: Class 2  
 Input Voltage (V): 120 - 277  
 Constant Current (MA): 700  
 Upon Request: (Not included - see components) Remote: Phase dimming @120Vac only / 0-10Vdc dimming (dimming requires min. 3 fixtures)

#### LED

Number of LEDs: 1  
 Color Temperature (°K): [3000 / 4000](#)  
 Nominal Lumen (lm): 124 / 133  
 CRI: >90 CRI  
 Lamp Life (hrs): 50000  
 Upon Request: 3500K

#### OPTICAL

Optic°: [12 / 28 / 44](#)

#### RATINGS AND CERTIFICATIONS

Certified By: Certified for North American Standards  
 IP rating: IP41 (Damp)  
 Upon Request: Damp Rated for Exterior

PROJECT
TYPE
SPECIFIER
QUANTITY
DATE

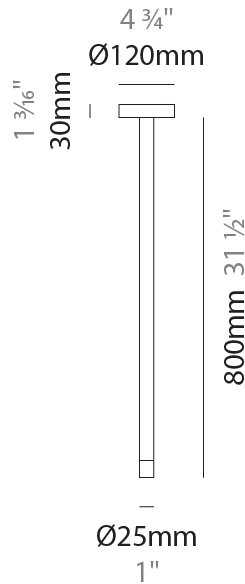

## METROPOLIS MONOPOINT SURFACE

D202001-

PROJECT

TYPE

SPECIFIER

QUANTITY

DATE

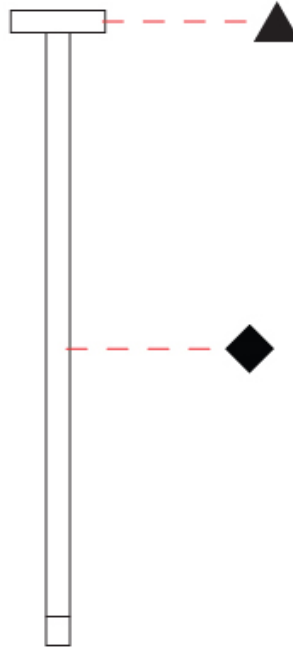

D

PROJECT	_____
TYPE	_____
SPECIFIER	_____
QUANTITY	_____
DATE	_____

## METROPOLIS MONOPOINT HALO SURFACE

### D202002-

base number    Color    Finish    Finish    Lens  
 Temperature    (Diamond)    (Triangle)    Options

- To build a product code in our configurator select the specify button on the base model # product page
- To build a manual product code on this datasheet choose from the options listed below in blue font and add the suffix to the base model #

#### GENERAL

Series: Metropolis  
 Subseries: Metropolis Monopoint Halo  
 Brand: Zaneen  
 Division: Design  
 Mounting Type: Surface  
 Mounting Location: Ceiling  
 Subcategory: Pendant

#### PHYSICAL

Shape: Cylinder  
 Diameter (mm): 120  
 Diameter (in): 4 ¾  
 Height (mm): 520  
 Height (in): 20 ½  
 Light Distribution: Downlight  
 Fixture Finish: [BLK](#) / [BRZ](#) / [IND](#)  
 Holder Finish: [BLK](#) / [BRZ](#) / [IND](#) / [WHI](#)  
 Fixture Material: Aluminum  
 Upon Request: Cylinder height. Max. 1830 mm / 72". Min 153mm / 6".  
 Min. qty required 50 pcs.

#### ELECTRICAL

Lamp Type: LED  
 Input Wattage (W): 3.65  
 Total Output Wattage (W): 2.7  
 Dimming: Non-Dimmable  
 Driver Included: Yes  
 Driver Location: Integrated  
 Driver Type: Constant Current - Universal  
 Driver Class: Class 2  
 Input Voltage (V): 120 - 277  
 Constant Current (MA): 700  
 Upon Request: (Not included - see components) Remote: Phase dimming @120Vac only / 0-10Vdc dimming (dimming requires min. 3 fixtures)

#### LED

Number of LEDs: 1  
 Color Temperature (°K): [3000](#) / [4000](#)  
 Nominal Lumen (lm): 124 / 133  
 CRI: >90 CRI  
 Lamp Life (hrs): 50000  
 Upon Request: 3500K

#### OPTICAL

Optic°: [12](#) / [28](#) / [44](#)

#### RATINGS AND CERTIFICATIONS

Certified By: Certified for North American Standards  
 IP rating: IP41 (Damp)  
 Upon Request: Damp Rated for Exterior

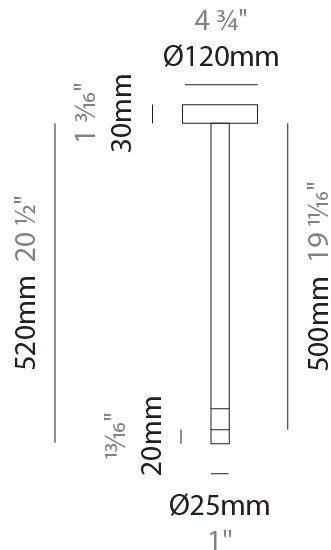

## METROPOLIS MONOPOINT HALO SURFACE

D202002-

PROJECT

TYPE

SPECIFIER

QUANTITY

DATE



D

## METROPOLIS MONOPOINT HALO SURFACE

### D202003-

base number      Color      Finish      Finish      Lens  
 Temperature      (Diamond)      (Triangle)      Options

- To build a product code in our configurator select the specify button on the base model # product page
- To build a manual product code on this datasheet choose from the options listed below in blue font and add the suffix to the base model #

#### GENERAL

Series: Metropolis  
 Subseries: Metropolis Monopoint Halo  
 Brand: Zaneen  
 Division: Design  
 Mounting Type: Surface  
 Mounting Location: Ceiling  
 Subcategory: Pendant

#### PHYSICAL

Shape: Cylinder  
 Diameter (mm): 120  
 Diameter (in): 4 3/4  
 Height (mm): 820  
 Height (in): 32 5/16  
 Light Distribution: Downlight  
 Fixture Finish: [BLK / BRZ / IND](#)  
 Holder Finish: [BLK / BRZ / IND / WHI](#)  
 Fixture Material: Aluminum  
 Upon Request: Cylinder height. Max. 1830 mm / 72". Min 153mm / 6".  
 Min. qty required 50 pcs.

#### ELECTRICAL

Lamp Type: LED  
 Input Wattage (W): 3.65  
 Total Output Wattage (W): 2.7  
 Dimming: Non-Dimmable  
 Driver Included: Yes  
 Driver Location: Integrated  
 Driver Type: Constant Current - Universal  
 Driver Class: Class 2  
 Input Voltage (V): 120 - 277  
 Constant Current (MA): 700  
 Upon Request: (Not included - see components) Remote: Phase dimming @120Vac only / 0-10Vdc dimming (dimming requires min. 3 fixtures)

#### LED

Number of LEDs: 1  
 Color Temperature (°K): [3000 / 4000](#)  
 Nominal Lumen (lm): 124 / 133  
 CRI: >90 CRI  
 Lamp Life (hrs): 50000  
 Upon Request: 3500K

#### OPTICAL

Optic°: [12 / 28 / 44](#)

#### RATINGS AND CERTIFICATIONS

Certified By: Certified for North American Standards  
 IP rating: IP41 (Damp)  
 Upon Request: Damp Rated for Exterior

PROJECT
TYPE
SPECIFIER
QUANTITY
DATE

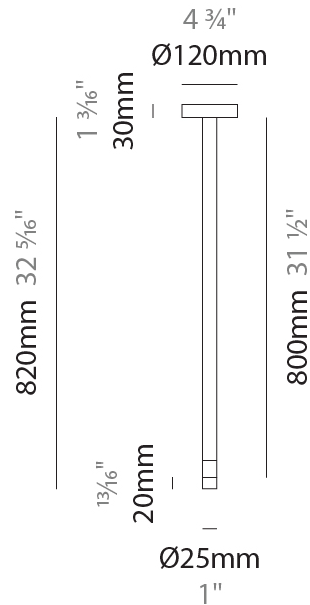

## METROPOLIS MONOPOINT HALO SURFACE

D202003-

PROJECT

TYPE

SPECIFIER

QUANTITY

DATE



D



## METROPOLIS MONOPOINT SURFACE

### D202004-

base number    Color    Finish    Finish    Lens  
 Temperature    (Diamond)    (Triangle)    Options

- To build a product code in our configurator select the specify button on the base model # product page
- To build a manual product code on this datasheet choose from the options listed below in blue font and add the suffix to the base model #

#### GENERAL

Series: Metropolis  
 Subseries: Metropolis Monopoint  
 Brand: Zaneen  
 Division: Design  
 Mounting Type: Surface  
 Mounting Location: Ceiling  
 Subcategory: Pendant

#### PHYSICAL

Shape: Cylinder  
 Diameter (mm): 80  
 Diameter (in): 3 1/8  
 Height (mm): 500  
 Height (in): 19 11/16  
 Light Distribution: Downlight  
 Fixture Finish: [BLK / BRZ / IND](#)  
 Holder Finish: [BLK / BRZ / IND / WHI](#)  
 Fixture Material: Aluminum  
 Upon Request: Cylinder height. Max. 1830 mm / 72". Min 153mm / 6".  
 Min. qty required 50 pcs.

#### ELECTRICAL

Lamp Type: LED  
 Input Wattage (W): 3.65  
 Total Output Wattage (W): 2.7  
 Dimming: Non-Dimmable  
 Driver Included: Yes  
 Driver Location: Integrated  
 Driver Type: Constant Current - Universal  
 Driver Class: Class 2  
 Input Voltage (V): 120 - 277  
 Constant Current (MA): 700  
 Upon Request: (Not included - see components) Remote: Phase dimming @120Vac only / 0-10Vdc dimming (dimming requires min. 3 fixtures)

#### LED

Number of LEDs: 1  
 Color Temperature (°K): [3000 / 4000](#)  
 Nominal Lumen (lm): 124 / 133  
 CRI: >90 CRI  
 Lamp Life (hrs): 50000  
 Upon Request: 3500K

#### OPTICAL

Optic°: [12 / 28 / 44](#)

#### RATINGS AND CERTIFICATIONS

Certified By: Certified for North American Standards  
 IP rating: IP41 (Damp)  
 Upon Request: Damp Rated for Exterior

PROJECT
TYPE
SPECIFIER
QUANTITY
DATE



## METROPOLIS MONOPOINT SURFACE

D202004-

PROJECT

TYPE

SPECIFIER

QUANTITY

DATE



D

## METROPOLIS MONOPOINT SURFACE

### D202005-

base number    Color    Finish    Finish    Lens  
 Temperature    (Diamond)    (Triangle)    Options

- To build a product code in our configurator select the specify button on the base model # product page
- To build a manual product code on this datasheet choose from the options listed below in blue font and add the suffix to the base model #

#### GENERAL

Series: Metropolis  
 Subseries: Metropolis Monopoint  
 Brand: Zaneen  
 Division: Design  
 Mounting Type: Surface  
 Mounting Location: Ceiling  
 Subcategory: Pendant

#### PHYSICAL

Shape: Cylinder  
 Diameter (mm): 80  
 Diameter (in): 3 1/8  
 Height (mm): 800  
 Height (in): 31 1/2  
 Light Distribution: Downlight  
 Fixture Finish: [BLK / BRZ / IND](#)  
 Holder Finish: [BLK / BRZ / IND / WHI](#)  
 Fixture Material: Aluminum  
 Upon Request: Cylinder height. Max. 1830 mm / 72". Min 153mm / 6".  
 Min. qty required 50 pcs.

#### ELECTRICAL

Lamp Type: LED  
 Input Wattage (W): 3.65  
 Total Output Wattage (W): 2.7  
 Dimming: Non-Dimmable  
 Driver Included: Yes  
 Driver Location: Integrated  
 Driver Type: Constant Current - Universal  
 Driver Class: Class 2  
 Input Voltage (V): 120 - 277  
 Constant Current (MA): 700  
 Upon Request: (Not included - see components) Remote: Phase dimming @120Vac only / 0-10Vdc dimming (dimming requires min. 3 fixtures)

#### LED

Number of LEDs: 1  
 Color Temperature (°K): [3000 / 4000](#)  
 Nominal Lumen (lm): 124 / 133  
 CRI: >90 CRI  
 Lamp Life (hrs): 50000  
 Upon Request: 3500K

#### OPTICAL

Optic°: [12 / 28 / 44](#)

#### RATINGS AND CERTIFICATIONS

Certified By: Certified for North American Standards  
 IP rating: IP41 (Damp)  
 Upon Request: Damp Rated for Exterior

PROJECT
TYPE
SPECIFIER
QUANTITY
DATE



## METROPOLIS MONOPOINT SURFACE

D202005-

PROJECT

TYPE

SPECIFIER

QUANTITY

DATE

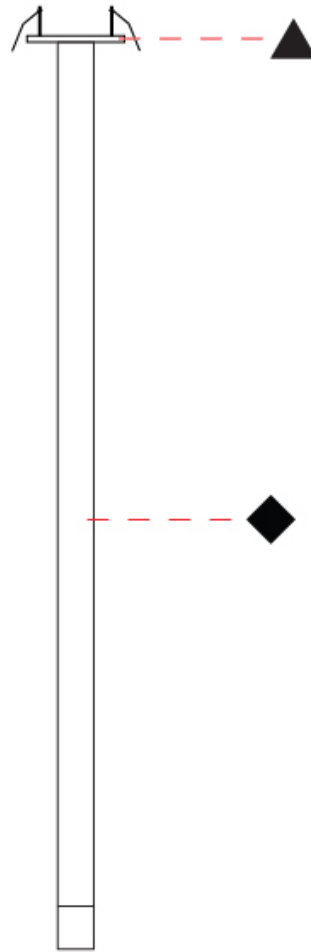

D

PROJECT	
TYPE	
SPECIFIER	
QUANTITY	
DATE	

## METROPOLIS MONOPOINT HALO SURFACE

### D202006-

base number	Color Temperature	Finish (Diamond)	Finish (Triangle)	Lens Options
-------------	----------------------	---------------------	----------------------	-----------------

- To build a product code in our configurator select the specify button on the base model # product page
- To build a manual product code on this datasheet choose from the options listed below in blue font and add the suffix to the base model #

#### GENERAL

Series: Metropolis
Subseries: Metropolis Monopoint Halo
Brand: Zaneen
Division: Design
Mounting Type: Surface
Mounting Location: Ceiling
Subcategory: Pendant

#### PHYSICAL

Shape: Cylinder
Diameter (mm): 80
Diameter (in): 3 1/8
Height (mm): 520
Height (in): 20 1/2
Light Distribution: Downlight
Fixture Finish: <a href="#">BLK</a> / <a href="#">BRZ</a> / <a href="#">IND</a>
Holder Finish: <a href="#">BLK</a> / <a href="#">BRZ</a> / <a href="#">IND</a> / <a href="#">WHI</a>
Fixture Material: Aluminum
Upon Request: Cylinder height. Max. 1830 mm / 72". Min 153mm / 6". Min. qty required 50 pcs.

#### ELECTRICAL

Lamp Type: LED
Input Wattage (W): 3.65
Total Output Wattage (W): 2.7
Dimming: Non-Dimmable
Driver Included: Yes
Driver Location: Integrated
Driver Type: Constant Current - Universal
Driver Class: Class 2
Input Voltage (V): 120 - 277
Constant Current (MA): 700
Upon Request: (Not included - see components) Remote: Phase dimming @120Vac only / 0-10Vdc dimming (dimming requires min. 3 fixtures)

#### LED

Number of LEDs: 1
Color Temperature (°K): <a href="#">3000</a> / <a href="#">4000</a>
Nominal Lumen (lm): 124 / 133
CRI: >90 CRI
Lamp Life (hrs): 50000
Upon Request: 3500K

#### OPTICAL

Optic°: <a href="#">12</a> / <a href="#">28</a> / <a href="#">44</a>
--

#### RATINGS AND CERTIFICATIONS

Certified By: Certified for North American Standards
IP rating: IP41 (Damp)
Upon Request: Damp Rated for Exterior

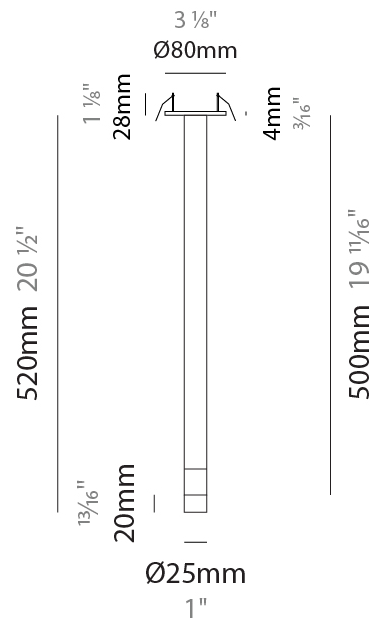

## METROPOLIS MONOPOINT HALO SURFACE

D202006-

PROJECT

TYPE

SPECIFIER

QUANTITY

DATE

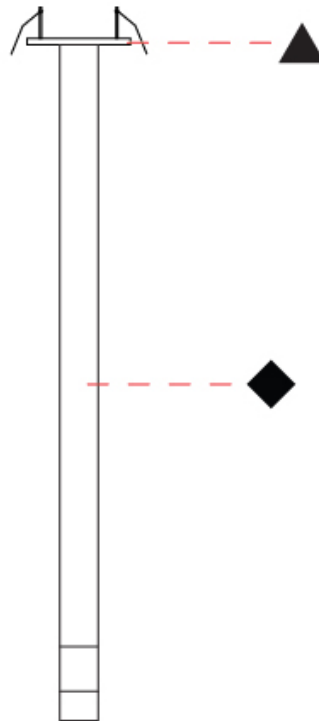

D

PROJECT
TYPE
SPECIFIER
QUANTITY
DATE

## METROPOLIS MONOPOINT HALO SURFACE

### D202006- : D202006-30K-BLK-BLK-12

base number

- To build a product code in our configurator select the specify button on the base model # product page
- To build a manual product code on this datasheet choose from the options listed below in blue font and add the suffix to the base model #

#### GENERAL

Series: Metropolis  
 Subseries: Metropolis Monopoint Halo  
 Brand: Zaneen  
 Division: Design  
 Mounting Type: Surface  
 Mounting Location: Ceiling  
 Subcategory: Pendant

#### PHYSICAL

Shape: Cylinder  
 Diameter (mm): 80  
 Diameter (in): 3 1/8"  
 Height (mm): 520  
 Height (in): 20 1/2"  
 Light Distribution: Downlight  
 Fixture Material: Aluminum  
 Upon Request: Cylinder height. Max. 1830 mm / 72". Min 153mm / 6".  
 Min. qty required 50 pcs.

#### ELECTRICAL

Lamp Type: LED  
 Input Wattage (W): 3.65  
 Total Output Wattage (W): 2.7  
 Dimming: Non-Dimmable  
 Driver Included: Yes  
 Driver Location: Integrated  
 Driver Type: Constant Current - Universal  
 Driver Class: Class 2  
 Input Voltage (V): 120 - 277  
 Constant Current (MA): 700  
 Upon Request: (Not included - see components) Remote: Phase dimming @120Vac only / 0-10Vdc dimming (dimming requires min. 3 fixtures)

#### LED

Number of LEDs: 1  
 Color Temperature (°K): 3000  
 Nominal Lumen (lm): 124  
 CRI: >90 CRI  
 Lamp Life (hrs): 50000  
 Upon Request: 3500K

#### OPTICAL

Optic°: 12

#### RATINGS AND CERTIFICATIONS

Certified By: Certified for North American Standards  
 IP rating: IP41 (Damp)

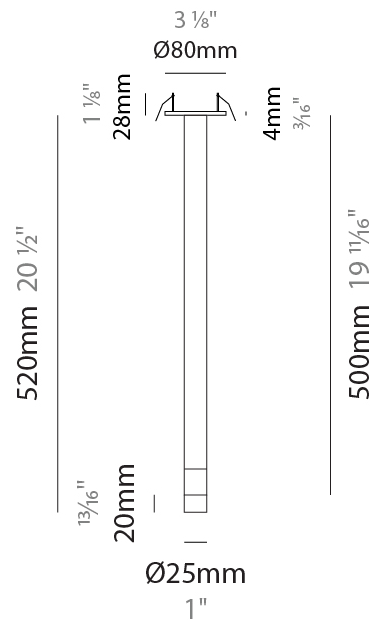

## METROPOLIS MONOPOINT HALO SURFACE

D202006- : D202006-30K-BLK-BLK-12

PROJECT

TYPE

SPECIFIER

QUANTITY

DATE



D



## METROPOLIS MONOPOINT HALO SURFACE

### D202007-

base number    Color    Finish    Finish    Lens  
 Temperature    (Diamond)    (Triangle)    Options

- To build a product code in our configurator select the specify button on the base model # product page
- To build a manual product code on this datasheet choose from the options listed below in blue font and add the suffix to the base model #

#### GENERAL

Series: Metropolis  
 Subseries: Metropolis Monopoint Halo  
 Brand: Zaneen  
 Division: Design  
 Mounting Type: Surface  
 Mounting Location: Ceiling  
 Subcategory: Pendant

#### PHYSICAL

Shape: Cylinder  
 Diameter (mm): 80  
 Diameter (in): 3 1/8  
 Height (mm): 820  
 Height (in): 32 5/16  
 Light Distribution: Downlight  
 Fixture Finish: [BLK / BRZ / IND](#)  
 Holder Finish: [BLK / BRZ / IND / WHI](#)  
 Fixture Material: Aluminum  
 Upon Request: Cylinder height. Max. 1830 mm / 72". Min 153mm / 6".  
 Min. qty required 50 pcs.

#### ELECTRICAL

Lamp Type: LED  
 Input Wattage (W): 3.65  
 Total Output Wattage (W): 2.7  
 Dimming: Non-Dimmable  
 Driver Included: Yes  
 Driver Location: Integrated  
 Driver Type: Constant Current - Universal  
 Driver Class: Class 2  
 Input Voltage (V): 120 - 277  
 Constant Current (MA): 700  
 Upon Request: (Not included - see components) Remote: Phase dimming @120Vac only / 0-10Vdc dimming (dimming requires min. 3 fixtures)

#### LED

Number of LEDs: 1  
 Color Temperature (°K): [3000 / 4000](#)  
 Nominal Lumen (lm): 124 / 133  
 CRI: >90 CRI  
 Lamp Life (hrs): 50000  
 Upon Request: 3500K

#### OPTICAL

Optic°: [12 / 28 / 44](#)

#### RATINGS AND CERTIFICATIONS

Certified By: Certified for North American Standards  
 IP rating: IP41 (Damp)  
 Upon Request: Damp Rated for Exterior

PROJECT
TYPE
SPECIFIER
QUANTITY
DATE

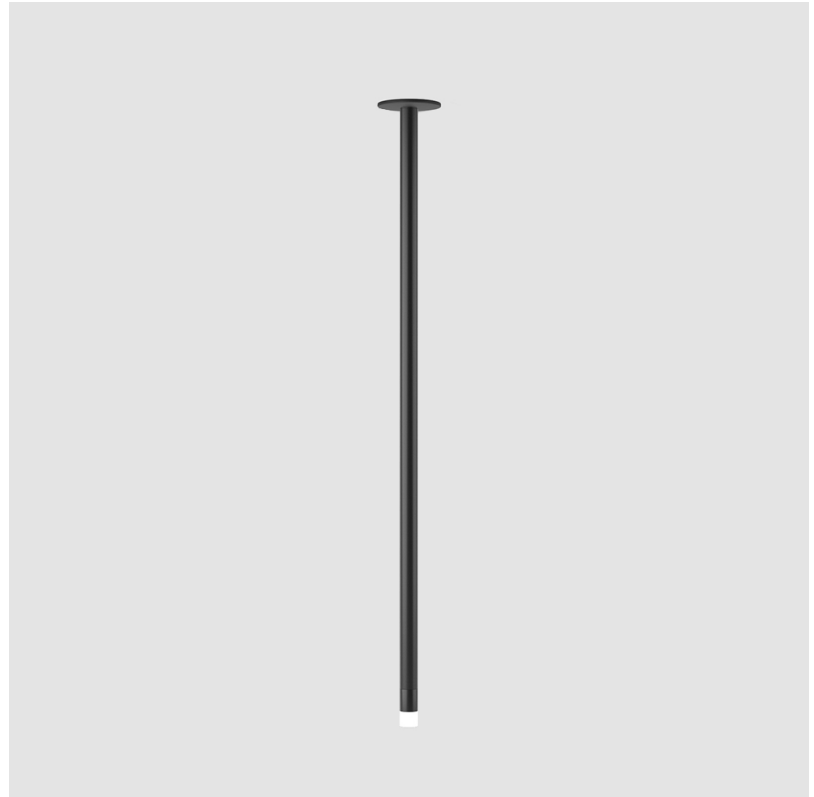

## METROPOLIS MONOPOINT HALO SURFACE

D202007-

PROJECT

TYPE

SPECIFIER

QUANTITY

DATE

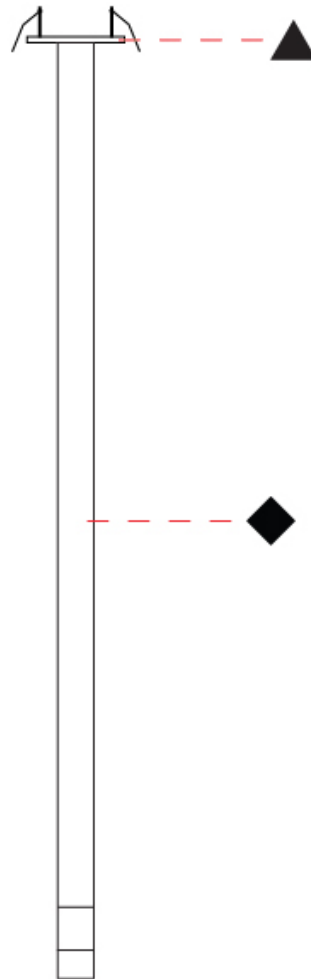

D

PROJECT \_\_\_\_\_

TYPE \_\_\_\_\_

SPECIFIER \_\_\_\_\_

QUANTITY \_\_\_\_\_

DATE \_\_\_\_\_

### Fixture Finish

Black - BLK

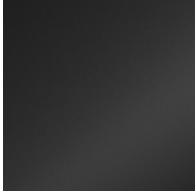

Bronze - BRZ

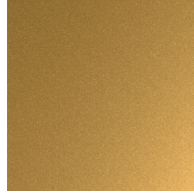

Industrial - IND



### Holder Finish

Black - BLK

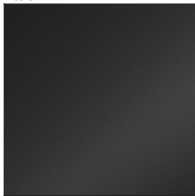

Bronze - BRZ

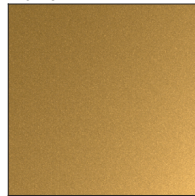

Industrial - IND

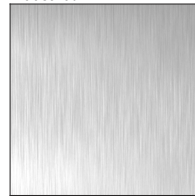

White - WHI



**Digital:** Not all screens are calibrated the same, and therefore, colors will appear differently between screens.

**Physical:** When texture is involved, there will be variations in color, character and tone within a product series and between product families.



PROJECT	
TYPE	
SPECIFIER	
QUANTITY	
DATE	

### LEGEND

floor-mounted	pivotal	special LED (upon request) RGB, RGBW, tunable, gold+, meat+, art+, fashion+
wall and ceiling: recessed and surface mounted	rotating	warm dim / natural dimming LED
ceiling-mounted and wall-mounted	illuminate tilted	rechargeable battery powered
wall-mounted	color of suspension cable	fixture with natural vivid LED (upon request)
omni-directional light distribution	length of suspension cable	color rendering index
direct light distribution	reflector degree selection	color temperature
direct/indirect light distribution	super spot	lumen (luminous flux)
indirect light distribution	lens	efficacy (lumens per watt)
asymmetric light distribution	lens pack	Unified Glare Rating (UGR) range from 5-40
aura light distribution	shine ring	marine grade (AISI 316 stainless steel)
round wall or ceiling cut-out	integrated shine ring with diffuser	walk on
square wall or ceiling cut-out	free individual colors 01-29	drive on
the supplied jig specifies the cutout dimensions	individual colors: 00 (free of charge), 01-25 (extra charge)	Dark Sky Compliance
minimum distance (meters) lamp - object	luminaire part to be colored (F1)	Americans with Disabilities Act (less than 4" off the wall located between 27"-84" from floor)
recessed depth	luminaire part to be colored (F2)	lamp protected against explosion
ceiling thickness in mm	luminaire part to be colored (F3)	blown glass using traditional methods by master glass blower
ceiling thickness selection	luminaire part to be colored (F4)	acoustic material
dimmable DP (phase), DV (0-10V), DD (dali), DS (step-dim)	luminaire part to be colored (F5)	protection class I, protection insulation
included or excluded LED driver/transformer/control gear	color of 3-circuit adaptor	protection class II, protection insulation
separately switchable	indirect diffuser	ETL Certified to UL and CSA Standards
sensor	direct diffuser	UL Certified to UL and CSA Standards
remote control	ball-proof (upon request)	CSA Certified to UL and CSA Standards
available upon request	accessory	Certified for North American Standards

### IP RATING

IP20	protected against ingress of solid bodies greater than 12.5mm (finger)
IP33	protected against ingress of solid bodies greater than 2.5mm protected against sprays of water up to 60 degrees from the vertical (rain)
IP40	protected against ingress of solid bodies greater than 1mm (wire) no protection against the ingress of moisture
IP43	protected against ingress of solid bodies greater than 1mm (wire) protected against sprays of water up to 60 degrees from the vertical (rain)
IP44	protected against ingress of solid bodies greater than 1mm (wire) protected against water splashed from all directions
IP54	protected against limited ingress of dust (wet rooms/covered outdoor areas) protected against water splashed from all directions
IP65	protected against ingress of dust protected against jets of water
IP66	protected against ingress of dust protected against powerful jets of water or heavy seas
IP67	protected against ingress of dust protected against immersion of water between 15cm - 1m for 30 minutes
IP68	protected against ingress of dust protected against immersion of water under pressure for long periods

### IK RATING

IK01	protected against 0.14 joules impact (equivalent to 0.25kg mass dropped from 56mm above the surface)
IK02	protected against 0.2 joules impact (equivalent to 0.25kg mass dropped from 80mm above the surface)
IK03	protected against 0.35 joules impact (equivalent to 0.25kg mass dropped from 140mm above the surface)
IK04	protected against 0.5 joules impact (equivalent to 0.25kg mass dropped from 200mm above the surface)
IK05	protected against 0.7 joules impact (equivalent to 0.25kg mass dropped from 280mm above the surface)
IK06	protected against 1 joules impact (equivalent to 0.25kg mass dropped from 400mm above the surface)
IK07	protected against 2 joules impact (equivalent to 0.5kg mass dropped from 400mm above the surface)
IK08	protected against 5 joules impact (equivalent to 1.7kg mass dropped from 300mm above the surface)
IK09	protected against 10 joules impact (equivalent to 5.0kg mass dropped from 200mm above the surface)
IK10	protected against 20 joules impact (equivalent to 5.0kg mass dropped from 400mm above the surface)