

|           |  |
|-----------|--|
| PROJECT   |  |
| TYPE      |  |
| SPECIFIER |  |
| QUANTITY  |  |
| DATE      |  |

## METROPOLIS MONOPOINT SUSPENSION

### D201026-

|             |                      |                     |                      |                 |                  |
|-------------|----------------------|---------------------|----------------------|-----------------|------------------|
| base number | Color<br>Temperature | Finish<br>(Diamond) | Finish<br>(Triangle) | Lens<br>Options | Cable<br>Options |
|-------------|----------------------|---------------------|----------------------|-----------------|------------------|

- To build a product code in our configurator select the specify button on the base model # product page
- To build a manual product code on this datasheet choose from the options listed below in blue font and add the suffix to the base model #

#### GENERAL

|                                 |
|---------------------------------|
| Series: Metropolis              |
| Subseries: Metropolis Monopoint |
| Brand: Zaneen                   |
| Division: Design                |
| Mounting Type: Suspension       |
| Mounting Location: Ceiling      |
| Subcategory: Pendant            |

#### PHYSICAL

|   |
|---|
| Shape: Cylinder   |
| Diameter (mm): 25   |
| Diameter (in): 1  |
| Height (mm): 500  |
| Height (in): 19 11/16   |
| Light Distribution: Downlight   |
| Fixture Finish: <a href="#">BLK / BRZ / IND</a>   |
| Holder Finish: <a href="#">BLK / BRZ / IND</a>  |
| Fixture Material: <a href="#">Aluminum</a>  |
| Cable Details: <a href="#">Black or Transparent - 3500mm / 137 13 / 16"</a>                     |
| Upon Request: Cylinder height. Max. 1830 mm / 72". Min 153mm / 6".<br>Min. qty required 50 pcs. |

#### ELECTRICAL

|   |
|---|
| Lamp Type: LED  |
| Input Wattage (W): 3.65   |
| Total Output Wattage (W): 2.7   |
| Dimming: Non-Dimmable   |
| Driver Included: Yes  |
| Driver Location: Integrated   |
| Driver Type: Constant Current - Universal   |
| Driver Class: Class 2   |
| Input Voltage (V): 120 - 277  |
| Constant Current (MA): 700  |
| Upon Request: Remote: Phase dimming @120Vac only / 0-10Vdc dimming (dimming requires min. 3 fixtures) |

#### LED

|   |
|---|
| Number of LEDs: 1                                   |
| Color Temperature (°K): <a href="#">3000 / 4000</a> |
| Max. Delivered Lumen (lm): 114 / 122                |
| Nominal Lumen (lm): 124 / 133                       |
| CRI: >90 CRI  |
| Lamp Life (hrs): 50000                              |
| Upon Request: 3500K                                 |

#### OPTICAL

|                                      |
|--------------------------------------|
| Optic°: <a href="#">12 / 28 / 44</a> |
|--------------------------------------|

#### RATINGS AND CERTIFICATIONS

|  |
|--|
| Certified By: Certified for North American Standards |
| IP rating: IP41 (Damp)                               |
| Upon Request: Damp Rated for Exterior                |



## METROPOLIS MONOPOINT SUSPENSION

D201026-

PROJECT

TYPE

SPECIFIER

QUANTITY

DATE

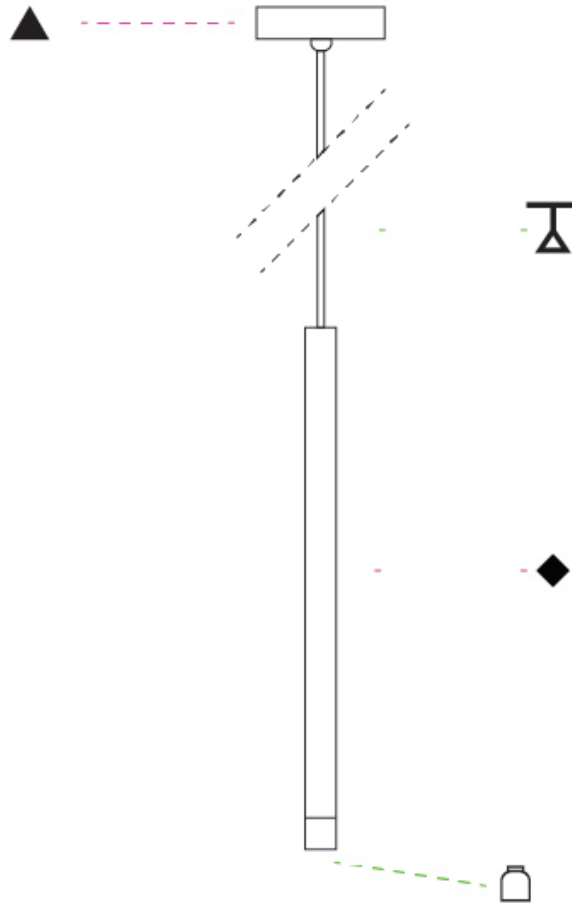

D

## METROPOLIS MONOPOINT SUSPENSION

### D201027-

base number    Color    Finish    Finish    Lens    Cable  
 Temperature    (Diamond)    (Triangle)    Options    Options

- To build a product code in our configurator select the specify button on the base model # product page
- To build a manual product code on this datasheet choose from the options listed below in blue font and add the suffix to the base model #

#### GENERAL

Series: Metropolis  
 Subseries: Metropolis Monopoint  
 Brand: Zaneen  
 Division: Design  
 Mounting Type: Suspension  
 Mounting Location: Ceiling  
 Subcategory: Pendant

#### PHYSICAL

Shape: Cylinder  
 Diameter (mm): 26  
 Diameter (in): 1  
 Height (mm): 800  
 Height (in): 31 1/2  
 Light Distribution: Downlight  
 Fixture Finish: [BLK / BRZ / IND](#)  
 Holder Finish: [BLK / BRZ / IND](#)  
 Fixture Material: Aluminum  
 Cable Details: [Black or Transparent - 3500mm / 137 13 / 16"](#)  
 Upon Request: Cylinder height. Max. 1830 mm / 72". Min 153mm / 6".  
 Min. qty required 50 pcs.

#### ELECTRICAL

Lamp Type: LED  
 Input Wattage (W): 3.65  
 Total Output Wattage (W): 2.7  
 Dimming: Non-Dimmable  
 Driver Included: Yes  
 Driver Location: Integrated  
 Driver Type: Constant Current - Universal  
 Driver Class: Class 2  
 Input Voltage (V): 120 - 277  
 Constant Current (MA): 700  
 Upon Request: (Not included - see components) Remote: Phase dimming @120Vac only / 0-10Vdc dimming (dimming requires min. 3 fixtures)

#### LED

Number of LEDs: 1  
 Color Temperature (°K): [3000 / 4000](#)  
 Max. Delivered Lumen (lm): [114 / 122](#)  
 Nominal Lumen (lm): [124 / 133](#)  
 CRI: >90 CRI  
 Lamp Life (hrs): 50000  
 Upon Request: 3500K

#### OPTICAL

Optic°: [12 / 28 / 44](#)

#### RATINGS AND CERTIFICATIONS

Certified By: Certified for North American Standards  
 IP rating: IP41 (Damp)  
 Upon Request: Damp Rated for Exterior

|           |
|-----------|
| PROJECT   |
| TYPE      |
| SPECIFIER |
| QUANTITY  |
| DATE      |

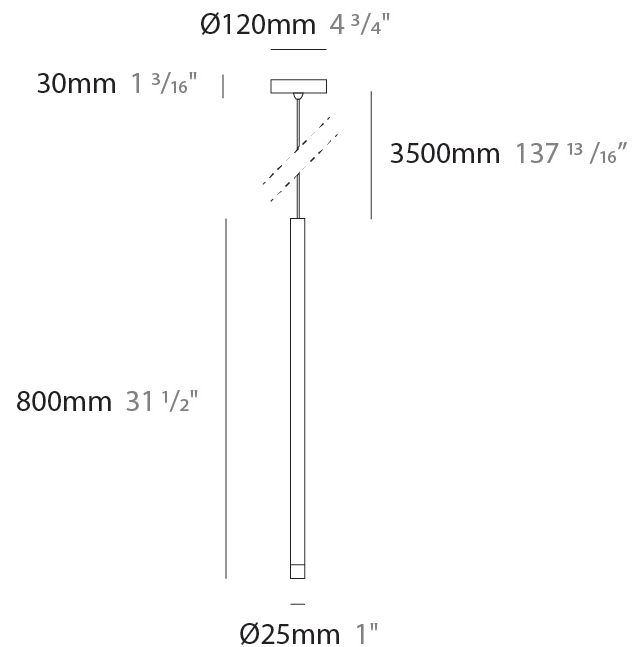

## METROPOLIS MONOPOINT SUSPENSION

D201027-

PROJECT

TYPE

SPECIFIER

QUANTITY

DATE

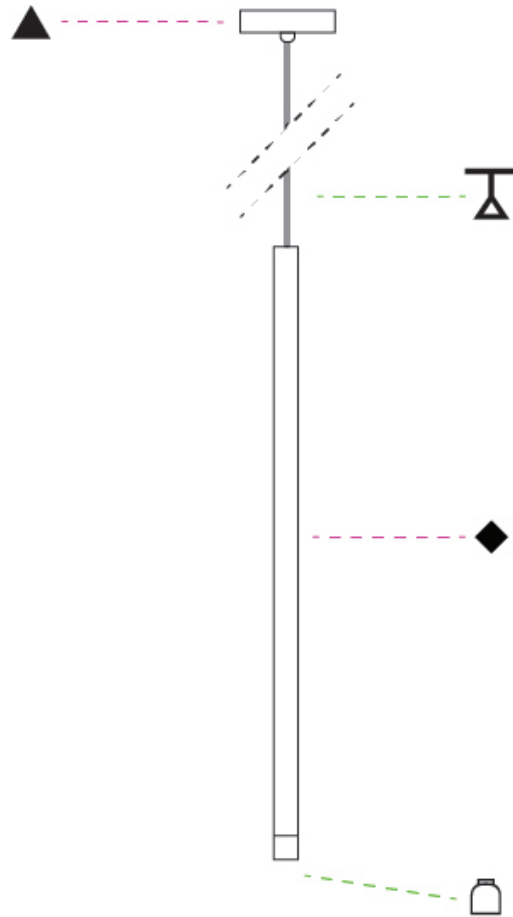

D

## METROPOLIS MONOPOINT HALO SUSPENSION

### D201032-

base number    Color    Finish    Finish    Lens    Cable  
 Temperature    (Diamond)    (Triangle)    Options    Options

- To build a product code in our configurator select the specify button on the base model # product page
- To build a manual product code on this datasheet choose from the options listed below in blue font and add the suffix to the base model #

#### GENERAL

Series: Metropolis  
 Subseries: Metropolis Monopoint Halo  
 Brand: Zaneen  
 Division: Design  
 Mounting Type: Suspension  
 Mounting Location: Ceiling  
 Subcategory: Pendant

#### PHYSICAL

Shape: Cylinder  
 Diameter (mm): 25  
 Diameter (in): 1  
 Height (mm): 520  
 Height (in): 20 1/2  
 Light Distribution: Downlight  
 Fixture Finish: [BLK / BRZ / IND](#)  
 Holder Finish: BLK / BRZ / IND  
 Fixture Material: Aluminum  
 Cable Details: [Black or Transparent - 3500mm / 137 13/16"](#)  
 Upon Request: Cylinder height. Max. 1830 mm / 72". Min 153mm / 6".  
 Min. qty required 50 pcs.

#### ELECTRICAL

Lamp Type: LED  
 Input Wattage (W): 3.65  
 Total Output Wattage (W): 2.7  
 Dimming: Non-Dimmable  
 Driver Included: Yes  
 Driver Location: Integrated  
 Driver Type: Constant Current - Universal  
 Driver Class: Class 2  
 Input Voltage (V): 120 - 277  
 Constant Current (MA): 700  
 Upon Request: Remote: Phase dimming @120Vac only / 0-10Vdc dimming (dimming requires min. 3 fixtures)

#### LED

Number of LEDs: 1  
 Color Temperature (°K): [3000 / 4000](#)  
 Max. Delivered Lumen (lm): 114 / 122  
 Nominal Lumen (lm): 124 / 133  
 CRI: >90 CRI  
 Lamp Life (hrs): 50000  
 Upon Request: 3500K

#### OPTICAL

Optic°: [12 / 28 / 44](#)  
 Upon Request: Damp Rated for Exterior

#### RATINGS AND CERTIFICATIONS

Certified By: Certified for North American Standards  
 IP rating: IP41 (Damp)



## METROPOLIS MONOPOINT HALO SUSPENSION

D201032-

PROJECT

TYPE

SPECIFIER

QUANTITY

DATE



D

|           |  |
|-----------|--|
| PROJECT   |  |
| TYPE      |  |
| SPECIFIER |  |
| QUANTITY  |  |
| DATE      |  |

## METROPOLIS MONOPOINT HALO SUSPENSION

### D201033-

|             |                      |                     |                      |                 |                  |
|-------------|----------------------|---------------------|----------------------|-----------------|------------------|
| base number | Color<br>Temperature | Finish<br>(Diamond) | Finish<br>(Triangle) | Lens<br>Options | Cable<br>Options |
|-------------|----------------------|---------------------|----------------------|-----------------|------------------|

- To build a product code in our configurator select the specify button on the base model # product page
- To build a manual product code on this datasheet choose from the options listed below in blue font and add the suffix to the base model #

#### GENERAL

|                                      |
|--------------------------------------|
| Series: Metropolis                   |
| Subseries: Metropolis Monopoint Halo |
| Brand: Zaneen                        |
| Division: Design                     |
| Mounting Type: Suspension            |
| Mounting Location: Ceiling           |
| Subcategory: Pendant                 |

#### PHYSICAL

|   |
|---|
| Shape: Cylinder   |
| Diameter (mm): 26   |
| Diameter (in): 1  |
| Height (mm): 820  |
| Height (in): 32 5/16"   |
| Light Distribution: Downlight   |
| Fixture Finish: <a href="#">BLK</a> / <a href="#">BRZ</a> / <a href="#">IND</a>                 |
| Holder Finish: <a href="#">BLK</a> / <a href="#">BRZ</a> / <a href="#">IND</a>                  |
| Fixture Material: Aluminum  |
| <a href="#">Cable Details: Black or Transparent - 3500mm / 137 13/16"</a>                       |
| Upon Request: Cylinder height. Max. 1830 mm / 72". Min 153mm / 6".<br>Min. qty required 50 pcs. |

#### ELECTRICAL

|   |
|---|
| Lamp Type: LED  |
| Input Wattage (W): 3.65   |
| Total Output Wattage (W): 2.7   |
| Dimming: Non-Dimmable   |
| Driver Included: Yes  |
| Driver Location: Integrated   |
| Driver Type: Constant Current - Universal   |
| Driver Class: Class 2   |
| Input Voltage (V): 120 - 277  |
| Constant Current (mA): 700  |
| Upon Request: Remote: Phase dimming @120Vac only / 0-10Vdc dimming (dimming requires min. 3 fixtures) |

#### LED

|   |
|---|
| Number of LEDs: 1   |
| Color Temperature (°K): <a href="#">3000</a> / <a href="#">4000</a> |
| Max. Delivered Lumen (lm): 114 / 122                                |
| Nominal Lumen (lm): 124 / 133                                       |
| CRI: >90 CRI  |
| Lamp Life (hrs): 50000  |
| Upon Request: 3500K   |

#### OPTICAL

|  |
|--|
| Optic°: <a href="#">12</a> / <a href="#">28</a> / <a href="#">44</a> |
|--|

#### RATINGS AND CERTIFICATIONS

|  |
|--|
| Certified By: Certified for North American Standards |
| IP rating: IP41 (Damp)                               |
| Upon Request: Damp Rated for Exterior                |



## METROPOLIS MONOPOINT HALO SUSPENSION

D201033-

|           |       |
|-----------|-------|
| PROJECT   | _____ |
| TYPE      | _____ |
| SPECIFIER | _____ |
| QUANTITY  | _____ |
| DATE      | _____ |

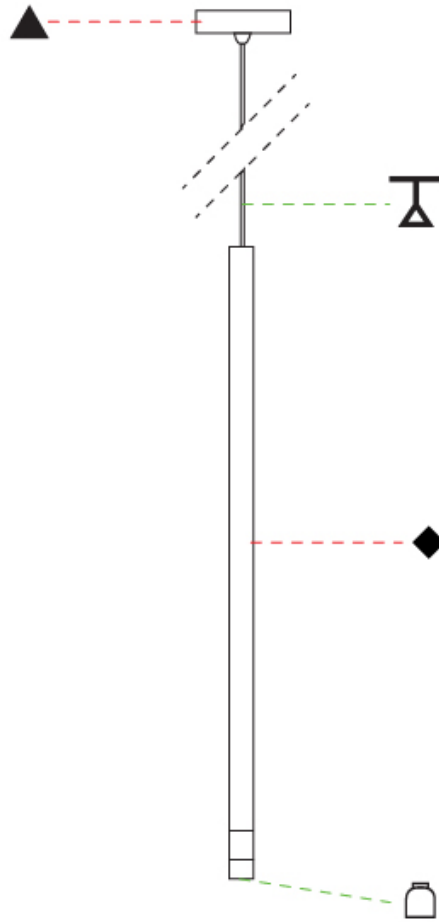

D



|           |
|-----------|
| PROJECT   |
| TYPE      |
| SPECIFIER |
| QUANTITY  |
| DATE      |

## METROPOLIS MONOPOINT SURFACE

### D202000-

base number    Color    Finish    Finish    Lens  
 Temperature    (Diamond)    (Triangle)    Options

- To build a product code in our configurator select the specify button on the base model # product page
- To build a manual product code on this datasheet choose from the options listed below in blue font and add the suffix to the base model #

#### GENERAL

Series: Metropolis  
 Subseries: Metropolis Monopoint  
 Brand: Zaneen  
 Division: Design  
 Mounting Type: Surface  
 Mounting Location: Ceiling  
 Subcategory: Pendant

#### PHYSICAL

Shape: Cylinder  
 Diameter (mm): 120  
 Diameter (in): 4 3/4  
 Height (mm): 500  
 Height (in): 19 11/16  
 Light Distribution: Downlight  
 Fixture Finish: [BLK / BRZ / IND](#)  
 Holder Finish: [BLK / BRZ / IND / WHI](#)  
 Fixture Material: Aluminum  
 Upon Request: Cylinder height. Max. 1830 mm / 72". Min 153mm / 6".  
 Min. qty required 50 pcs.

#### ELECTRICAL

Lamp Type: LED  
 Input Wattage (W): 3.65  
 Total Output Wattage (W): 2.7  
 Dimming: Non-Dimmable  
 Driver Included: Yes  
 Driver Location: Integrated  
 Driver Type: Constant Current - Universal  
 Driver Class: Class 2  
 Input Voltage (V): 120 - 277  
 Constant Current (MA): 700  
 Upon Request: (Not included - see components) Remote: Phase dimming @120Vac only / 0-10Vdc dimming (dimming requires min. 3 fixtures)

#### LED

Number of LEDs: 1  
 Color Temperature (°K): [3000 / 4000](#)  
 Nominal Lumen (lm): 124 / 133  
 CRI: >90 CRI  
 Lamp Life (hrs): 50000  
 Upon Request: 3500K

#### OPTICAL

Optic°: [12 / 28 / 44](#)

#### RATINGS AND CERTIFICATIONS

Certified By: Certified for North American Standards  
 IP rating: IP41 (Damp)  
 Upon Request: Damp Rated for Exterior

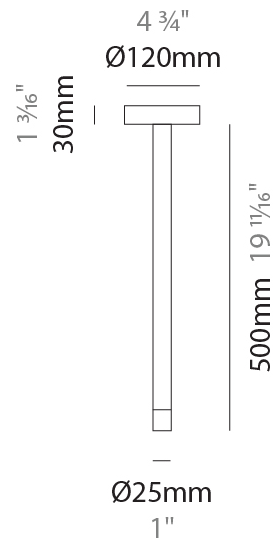

## METROPOLIS MONOPOINT SURFACE

D202000-

PROJECT

TYPE

SPECIFIER

QUANTITY

DATE



D

## METROPOLIS MONOPOINT SURFACE

### D202001-

base number    Color    Finish    Finish    Lens  
 Temperature    (Diamond)    (Triangle)    Options

- To build a product code in our configurator select the specify button on the base model # product page
- To build a manual product code on this datasheet choose from the options listed below in blue font and add the suffix to the base model #

#### GENERAL

Series: Metropolis  
 Subseries: Metropolis Monopoint  
 Brand: Zaneen  
 Division: Design  
 Mounting Type: Surface  
 Mounting Location: Ceiling  
 Subcategory: Pendant

#### PHYSICAL

Shape: Cylinder  
 Diameter (mm): 120  
 Diameter (in): 4 ¾  
 Height (mm): 800  
 Height (in): 31 ½  
 Light Distribution: Downlight  
 Fixture Finish: [BLK / BRZ / IND](#)  
 Holder Finish: [BLK / BRZ / IND / WHI](#)  
 Fixture Material: Aluminum  
 Upon Request: Cylinder height. Max. 1830 mm / 72". Min 153mm / 6".  
 Min. qty required 50 pcs.

#### ELECTRICAL

Lamp Type: LED  
 Input Wattage (W): 3.65  
 Total Output Wattage (W): 2.7  
 Dimming: Non-Dimmable  
 Driver Included: Yes  
 Driver Location: Integrated  
 Driver Type: Constant Current - Universal  
 Driver Class: Class 2  
 Input Voltage (V): 120 - 277  
 Constant Current (MA): 700  
 Upon Request: (Not included - see components) Remote: Phase dimming @120Vac only / 0-10Vdc dimming (dimming requires min. 3 fixtures)

#### LED

Number of LEDs: 1  
 Color Temperature (°K): [3000 / 4000](#)  
 Nominal Lumen (lm): 124 / 133  
 CRI: >90 CRI  
 Lamp Life (hrs): 50000  
 Upon Request: 3500K

#### OPTICAL

Optic°: [12 / 28 / 44](#)

#### RATINGS AND CERTIFICATIONS

Certified By: Certified for North American Standards  
 IP rating: IP41 (Damp)  
 Upon Request: Damp Rated for Exterior

|           |
|-----------|
| PROJECT   |
| TYPE      |
| SPECIFIER |
| QUANTITY  |
| DATE      |

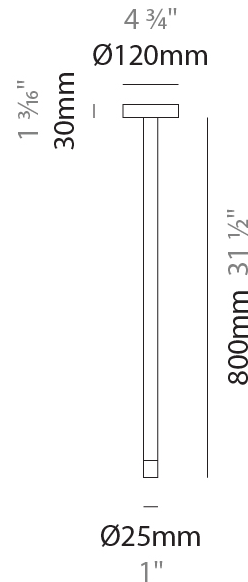

## METROPOLIS MONOPOINT SURFACE

D202001-

PROJECT

TYPE

SPECIFIER

QUANTITY

DATE



D

|           |       |
|-----------|-------|
| PROJECT   | _____ |
| TYPE      | _____ |
| SPECIFIER | _____ |
| QUANTITY  | _____ |
| DATE      | _____ |

## METROPOLIS MONOPOINT HALO SURFACE

### D202002-

base number    Color    Finish    Finish    Lens  
 Temperature    (Diamond)    (Triangle)    Options

- To build a product code in our configurator select the specify button on the base model # product page
- To build a manual product code on this datasheet choose from the options listed below in blue font and add the suffix to the base model #

#### GENERAL

Series: Metropolis  
 Subseries: Metropolis Monopoint Halo  
 Brand: Zaneen  
 Division: Design  
 Mounting Type: Surface  
 Mounting Location: Ceiling  
 Subcategory: Pendant

#### PHYSICAL

Shape: Cylinder  
 Diameter (mm): 120  
 Diameter (in): 4 3/4  
 Height (mm): 520  
 Height (in): 20 1/2  
 Light Distribution: Downlight  
 Fixture Finish: [BLK](#) / [BRZ](#) / [IND](#)  
 Holder Finish: [BLK](#) / [BRZ](#) / [IND](#) / [WHI](#)  
 Fixture Material: Aluminum  
 Upon Request: Cylinder height. Max. 1830 mm / 72". Min 153mm / 6".  
 Min. qty required 50 pcs.

#### ELECTRICAL

Lamp Type: LED  
 Input Wattage (W): 3.65  
 Total Output Wattage (W): 2.7  
 Dimming: Non-Dimmable  
 Driver Included: Yes  
 Driver Location: Integrated  
 Driver Type: Constant Current - Universal  
 Driver Class: Class 2  
 Input Voltage (V): 120 - 277  
 Constant Current (MA): 700  
 Upon Request: (Not included - see components) Remote: Phase dimming @120Vac only / 0-10Vdc dimming (dimming requires min. 3 fixtures)

#### LED

Number of LEDs: 1  
 Color Temperature (°K): [3000](#) / [4000](#)  
 Nominal Lumen (lm): 124 / 133  
 CRI: >90 CRI  
 Lamp Life (hrs): 50000  
 Upon Request: 3500K

#### OPTICAL

Optic°: [12](#) / [28](#) / [44](#)

#### RATINGS AND CERTIFICATIONS

Certified By: Certified for North American Standards  
 IP rating: IP41 (Damp)  
 Upon Request: Damp Rated for Exterior

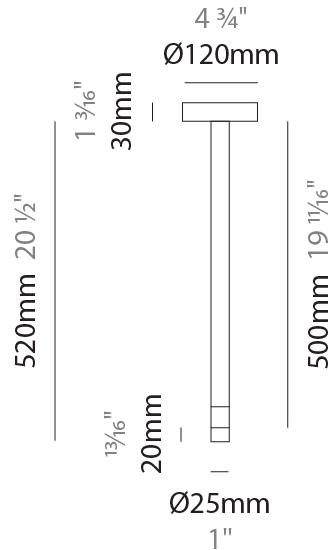

## METROPOLIS MONOPOINT HALO SURFACE

D202002-

PROJECT

TYPE

SPECIFIER

QUANTITY

DATE



D

## METROPOLIS MONOPOINT HALO SURFACE

### D202003-

base number    Color    Finish    Finish    Lens  
 Temperature    (Diamond)    (Triangle)    Options

- To build a product code in our configurator select the specify button on the base model # product page
- To build a manual product code on this datasheet choose from the options listed below in blue font and add the suffix to the base model #

#### GENERAL

Series: Metropolis  
 Subseries: Metropolis Monopoint Halo  
 Brand: Zaneen  
 Division: Design  
 Mounting Type: Surface  
 Mounting Location: Ceiling  
 Subcategory: Pendant

#### PHYSICAL

Shape: Cylinder  
 Diameter (mm): 120  
 Diameter (in): 4 3/4  
 Height (mm): 820  
 Height (in): 32 5/16  
 Light Distribution: Downlight  
 Fixture Finish: [BLK / BRZ / IND](#)  
 Holder Finish: [BLK / BRZ / IND / WHI](#)  
 Fixture Material: Aluminum  
 Upon Request: Cylinder height. Max. 1830 mm / 72". Min 153mm / 6".  
 Min. qty required 50 pcs.

#### ELECTRICAL

Lamp Type: LED  
 Input Wattage (W): 3.65  
 Total Output Wattage (W): 2.7  
 Dimming: Non-Dimmable  
 Driver Included: Yes  
 Driver Location: Integrated  
 Driver Type: Constant Current - Universal  
 Driver Class: Class 2  
 Input Voltage (V): 120 - 277  
 Constant Current (MA): 700  
 Upon Request: (Not included - see components) Remote: Phase dimming @120Vac only / 0-10Vdc dimming (dimming requires min. 3 fixtures)

#### LED

Number of LEDs: 1  
 Color Temperature (°K): [3000 / 4000](#)  
 Nominal Lumen (lm): 124 / 133  
 CRI: >90 CRI  
 Lamp Life (hrs): 50000  
 Upon Request: 3500K

#### OPTICAL

Optic°: [12 / 28 / 44](#)

#### RATINGS AND CERTIFICATIONS

Certified By: Certified for North American Standards  
 IP rating: IP41 (Damp)  
 Upon Request: Damp Rated for Exterior

|           |
|-----------|
| PROJECT   |
| TYPE      |
| SPECIFIER |
| QUANTITY  |
| DATE      |

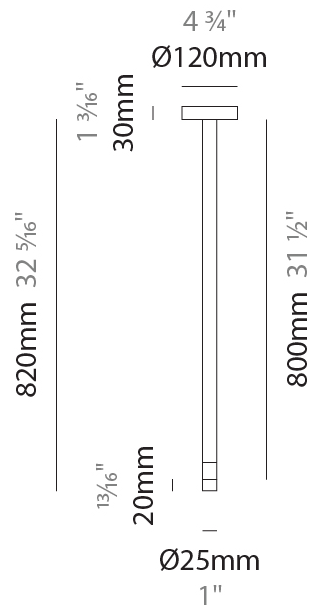

## METROPOLIS MONOPOINT HALO SURFACE

D202003-

PROJECT

TYPE

SPECIFIER

QUANTITY

DATE

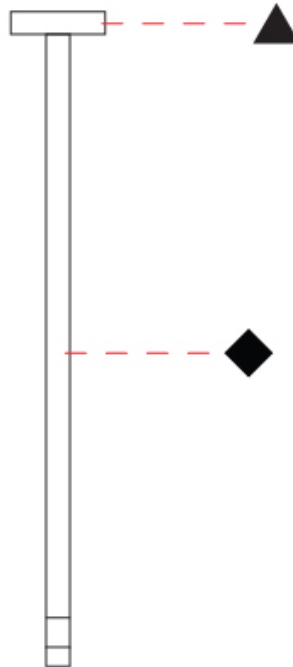

D



## METROPOLIS MONOPOINT SURFACE

### D202004-

base number    Color    Finish    Finish    Lens  
 Temperature    (Diamond)    (Triangle)    Options

- To build a product code in our configurator select the specify button on the base model # product page
- To build a manual product code on this datasheet choose from the options listed below in blue font and add the suffix to the base model #

#### GENERAL

Series: Metropolis  
 Subseries: Metropolis Monopoint  
 Brand: Zaneen  
 Division: Design  
 Mounting Type: Surface  
 Mounting Location: Ceiling  
 Subcategory: Pendant

#### PHYSICAL

Shape: Cylinder  
 Diameter (mm): 80  
 Diameter (in): 3 1/8  
 Height (mm): 500  
 Height (in): 19 11/16  
 Light Distribution: Downlight  
 Fixture Finish: [BLK / BRZ / IND](#)  
 Holder Finish: [BLK / BRZ / IND / WHI](#)  
 Fixture Material: Aluminum  
 Upon Request: Cylinder height. Max. 1830 mm / 72". Min 153mm / 6".  
 Min. qty required 50 pcs.

#### ELECTRICAL

Lamp Type: LED  
 Input Wattage (W): 3.65  
 Total Output Wattage (W): 2.7  
 Dimming: Non-Dimmable  
 Driver Included: Yes  
 Driver Location: Integrated  
 Driver Type: Constant Current - Universal  
 Driver Class: Class 2  
 Input Voltage (V): 120 - 277  
 Constant Current (MA): 700  
 Upon Request: (Not included - see components) Remote: Phase dimming @120Vac only / 0-10Vdc dimming (dimming requires min. 3 fixtures)

#### LED

Number of LEDs: 1  
 Color Temperature (°K): [3000 / 4000](#)  
 Nominal Lumen (lm): 124 / 133  
 CRI: >90 CRI  
 Lamp Life (hrs): 50000  
 Upon Request: 3500K

#### OPTICAL

Optic°: [12 / 28 / 44](#)

#### RATINGS AND CERTIFICATIONS

Certified By: Certified for North American Standards  
 IP rating: IP41 (Damp)  
 Upon Request: Damp Rated for Exterior

|           |
|-----------|
| PROJECT   |
| TYPE      |
| SPECIFIER |
| QUANTITY  |
| DATE      |



## METROPOLIS MONOPOINT SURFACE

D202004-

PROJECT

TYPE

SPECIFIER

QUANTITY

DATE



D

## METROPOLIS MONOPOINT SURFACE

### D202005-

base number    Color    Finish    Finish    Lens  
 Temperature    (Diamond)    (Triangle)    Options

- To build a product code in our configurator select the specify button on the base model # product page
- To build a manual product code on this datasheet choose from the options listed below in blue font and add the suffix to the base model #

#### GENERAL

Series: Metropolis  
 Subseries: Metropolis Monopoint  
 Brand: Zaneen  
 Division: Design  
 Mounting Type: Surface  
 Mounting Location: Ceiling  
 Subcategory: Pendant

#### PHYSICAL

Shape: Cylinder  
 Diameter (mm): 80  
 Diameter (in): 3 1/8"  
 Height (mm): 800  
 Height (in): 31 1/2"  
 Light Distribution: Downlight  
 Fixture Finish: [BLK](#) / [BRZ](#) / [IND](#)  
 Holder Finish: [BLK](#) / [BRZ](#) / [IND](#) / [WHI](#)  
 Fixture Material: Aluminum  
 Upon Request: Cylinder height. Max. 1830 mm / 72". Min 153mm / 6".  
 Min. qty required 50 pcs.

#### ELECTRICAL

Lamp Type: LED  
 Input Wattage (W): 3.65  
 Total Output Wattage (W): 2.7  
 Dimming: Non-Dimmable  
 Driver Included: Yes  
 Driver Location: Integrated  
 Driver Type: Constant Current - Universal  
 Driver Class: Class 2  
 Input Voltage (V): 120 - 277  
 Constant Current (MA): 700  
 Upon Request: (Not included - see components) Remote: Phase dimming @120Vac only / 0-10Vdc dimming (dimming requires min. 3 fixtures)

#### LED

Number of LEDs: 1  
 Color Temperature (°K): [3000](#) / [4000](#)  
 Nominal Lumen (lm): 124 / 133  
 CRI: >90 CRI  
 Lamp Life (hrs): 50000  
 Upon Request: 3500K

#### OPTICAL

Optic°: [12](#) / [28](#) / [44](#)

#### RATINGS AND CERTIFICATIONS

Certified By: Certified for North American Standards  
 IP rating: IP41 (Damp)  
 Upon Request: Damp Rated for Exterior

|           |
|-----------|
| PROJECT   |
| TYPE      |
| SPECIFIER |
| QUANTITY  |
| DATE      |

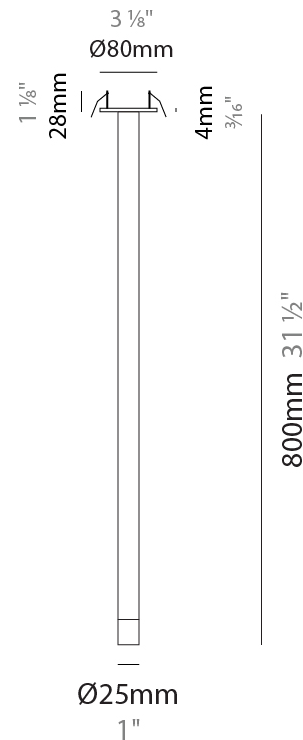

## METROPOLIS MONOPOINT SURFACE

D202005-

PROJECT

TYPE

SPECIFIER

QUANTITY

DATE

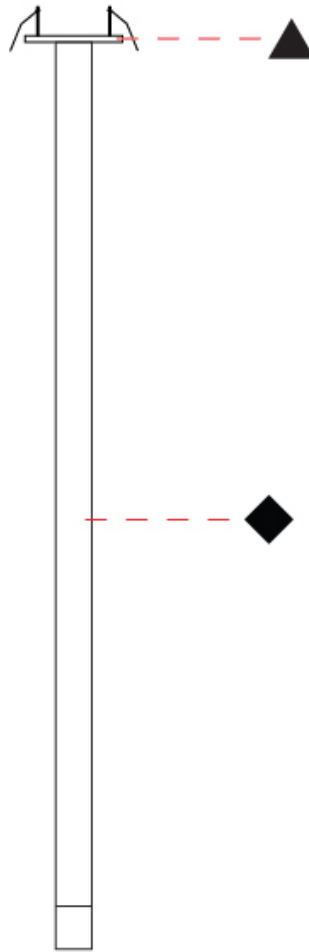

D

|           |
|-----------|
| PROJECT   |
| TYPE      |
| SPECIFIER |
| QUANTITY  |
| DATE      |

## METROPOLIS MONOPOINT HALO SURFACE

### D202006-

|             |                      |                     |                      |                 |
|-------------|----------------------|---------------------|----------------------|-----------------|
| base number | Color<br>Temperature | Finish<br>(Diamond) | Finish<br>(Triangle) | Lens<br>Options |
|-------------|----------------------|---------------------|----------------------|-----------------|

- To build a product code in our configurator select the specify button on the base model # product page
- To build a manual product code on this datasheet choose from the options listed below in blue font and add the suffix to the base model #

#### GENERAL

|                                      |
|--------------------------------------|
| Series: Metropolis                   |
| Subseries: Metropolis Monopoint Halo |
| Brand: Zaneen                        |
| Division: Design                     |
| Mounting Type: Surface               |
| Mounting Location: Ceiling           |
| Subcategory: Pendant                 |

#### PHYSICAL

|  |
|--|
| Shape: Cylinder  |
| Diameter (mm): 80  |
| Diameter (in): 3 1/8   |
| Height (mm): 520   |
| Height (in): 20 1/2  |
| Light Distribution: Downlight  |
| Fixture Finish: <a href="#">BLK</a> / <a href="#">BRZ</a> / <a href="#">IND</a>                      |
| Holder Finish: <a href="#">BLK</a> / <a href="#">BRZ</a> / <a href="#">IND</a> / <a href="#">WHI</a> |
| Fixture Material: Aluminum   |
| Upon Request: Cylinder height. Max. 1830 mm / 72". Min 153mm / 6". Min. qty required 50 pcs.         |

#### ELECTRICAL

|   |
|---|
| Lamp Type: LED  |
| Input Wattage (W): 3.65   |
| Total Output Wattage (W): 2.7   |
| Dimming: Non-Dimmable   |
| Driver Included: Yes  |
| Driver Location: Integrated   |
| Driver Type: Constant Current - Universal   |
| Driver Class: Class 2   |
| Input Voltage (V): 120 - 277  |
| Constant Current (MA): 700  |
| Upon Request: (Not included - see components) Remote: Phase dimming @120Vac only / 0-10Vdc dimming (dimming requires min. 3 fixtures) |

#### LED

|   |
|---|
| Number of LEDs: 1   |
| Color Temperature (°K): <a href="#">3000</a> / <a href="#">4000</a> |
| Nominal Lumen (lm): 124 / 133                                       |
| CRI: >90 CRI  |
| Lamp Life (hrs): 50000  |
| Upon Request: 3500K   |

#### OPTICAL

|  |
|--|
| Optic°: <a href="#">12</a> / <a href="#">28</a> / <a href="#">44</a> |
|--|

#### RATINGS AND CERTIFICATIONS

|  |
|--|
| Certified By: Certified for North American Standards |
| IP rating: IP41 (Damp)                               |
| Upon Request: Damp Rated for Exterior                |

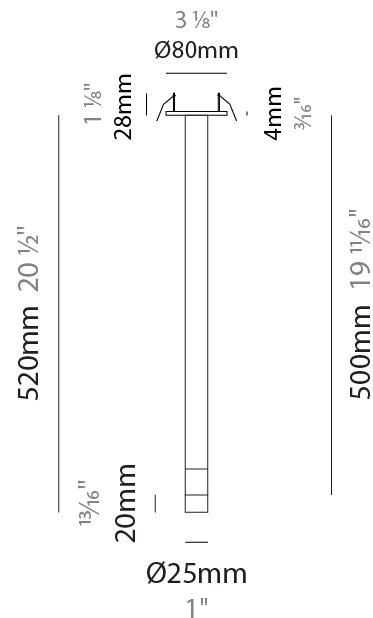

## METROPOLIS MONOPOINT HALO SURFACE

D202006-

PROJECT

TYPE

SPECIFIER

QUANTITY

DATE

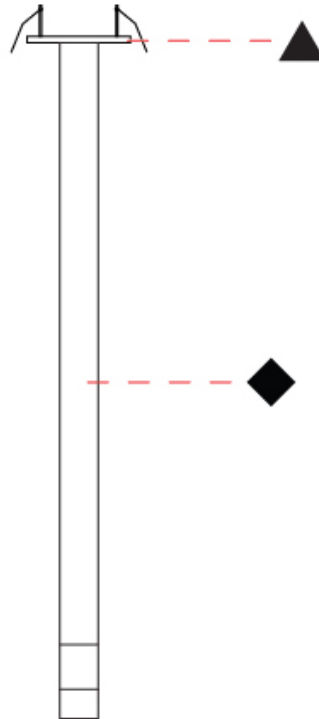

D

|           |
|-----------|
| PROJECT   |
| TYPE      |
| SPECIFIER |
| QUANTITY  |
| DATE      |

## METROPOLIS MONOPOINT HALO SURFACE

### D202006- : D202006-30K-BLK-BLK-12

base number

- To build a product code in our configurator select the specify button on the base model # product page
- To build a manual product code on this datasheet choose from the options listed below in blue font and add the suffix to the base model #

#### GENERAL

Series: Metropolis  
 Subseries: Metropolis Monopoint Halo  
 Brand: Zaneen  
 Division: Design  
 Mounting Type: Surface  
 Mounting Location: Ceiling  
 Subcategory: Pendant

#### PHYSICAL

Shape: Cylinder  
 Diameter (mm): 80  
 Diameter (in): 3 1/8"  
 Height (mm): 520  
 Height (in): 20 1/2"  
 Light Distribution: Downlight  
 Fixture Material: Aluminum  
 Upon Request: Cylinder height. Max. 1830 mm / 72". Min 153mm / 6".  
 Min. qty required 50 pcs.

#### ELECTRICAL

Lamp Type: LED  
 Input Wattage (W): 3.65  
 Total Output Wattage (W): 2.7  
 Dimming: Non-Dimmable  
 Driver Included: Yes  
 Driver Location: Integrated  
 Driver Type: Constant Current - Universal  
 Driver Class: Class 2  
 Input Voltage (V): 120 - 277  
 Constant Current (MA): 700  
 Upon Request: (Not included - see components) Remote: Phase dimming @120Vac only / 0-10Vdc dimming (dimming requires min. 3 fixtures)

#### LED

Number of LEDs: 1  
 Color Temperature (°K): 3000  
 Nominal Lumen (lm): 124  
 CRI: >90 CRI  
 Lamp Life (hrs): 50000  
 Upon Request: 3500K

#### OPTICAL

Optic°: 12

#### RATINGS AND CERTIFICATIONS

Certified By: Certified for North American Standards  
 IP rating: IP41 (Damp)

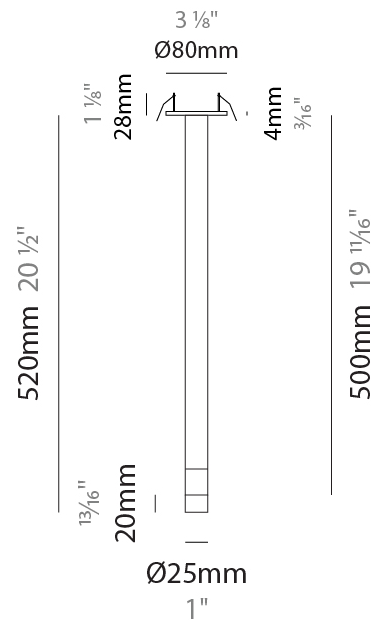

## METROPOLIS MONOPOINT HALO SURFACE

D202006- : D202006-30K-BLK-BLK-12

PROJECT

TYPE

SPECIFIER

QUANTITY

DATE



D



|           |  |
|-----------|--|
| PROJECT   |  |
| TYPE      |  |
| SPECIFIER |  |
| QUANTITY  |  |
| DATE      |  |

## METROPOLIS MONOPOINT HALO SURFACE

### D202007-

|             |                      |                     |                      |                 |
|-------------|----------------------|---------------------|----------------------|-----------------|
| base number | Color<br>Temperature | Finish<br>(Diamond) | Finish<br>(Triangle) | Lens<br>Options |
|-------------|----------------------|---------------------|----------------------|-----------------|

- To build a product code in our configurator select the specify button on the base model # product page
- To build a manual product code on this datasheet choose from the options listed below in blue font and add the suffix to the base model #

#### GENERAL

|                                      |
|--------------------------------------|
| Series: Metropolis                   |
| Subseries: Metropolis Monopoint Halo |
| Brand: Zaneen                        |
| Division: Design                     |
| Mounting Type: Surface               |
| Mounting Location: Ceiling           |
| Subcategory: Pendant                 |

#### PHYSICAL

|  |
|--|
| Shape: Cylinder  |
| Diameter (mm): 80  |
| Diameter (in): 3 1/8   |
| Height (mm): 820   |
| Height (in): 32 5/16   |
| Light Distribution: Downlight  |
| Fixture Finish: <a href="#">BLK</a> / <a href="#">BRZ</a> / <a href="#">IND</a>                      |
| Holder Finish: <a href="#">BLK</a> / <a href="#">BRZ</a> / <a href="#">IND</a> / <a href="#">WHI</a> |
| Fixture Material: Aluminum   |
| Upon Request: Cylinder height. Max. 1830 mm / 72". Min 153mm / 6".<br>Min. qty required 50 pcs.      |

#### ELECTRICAL

|   |
|---|
| Lamp Type: LED  |
| Input Wattage (W): 3.65   |
| Total Output Wattage (W): 2.7   |
| Dimming: Non-Dimmable   |
| Driver Included: Yes  |
| Driver Location: Integrated   |
| Driver Type: Constant Current - Universal   |
| Driver Class: Class 2   |
| Input Voltage (V): 120 - 277  |
| Constant Current (MA): 700  |
| Upon Request: (Not included - see components) Remote: Phase dimming @120Vac only / 0-10Vdc dimming (dimming requires min. 3 fixtures) |

#### LED

|   |
|---|
| Number of LEDs: 1   |
| Color Temperature (°K): <a href="#">3000</a> / <a href="#">4000</a> |
| Nominal Lumen (lm): 124 / 133                                       |
| CRI: >90 CRI  |
| Lamp Life (hrs): 50000  |
| Upon Request: 3500K   |

#### OPTICAL

|  |
|--|
| Optic°: <a href="#">12</a> / <a href="#">28</a> / <a href="#">44</a> |
|--|

#### RATINGS AND CERTIFICATIONS

|  |
|--|
| Certified By: Certified for North American Standards |
| IP rating: IP41 (Damp)                               |
| Upon Request: Damp Rated for Exterior                |

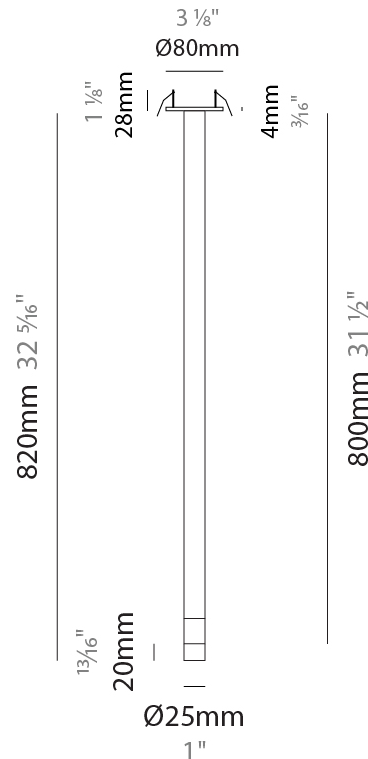
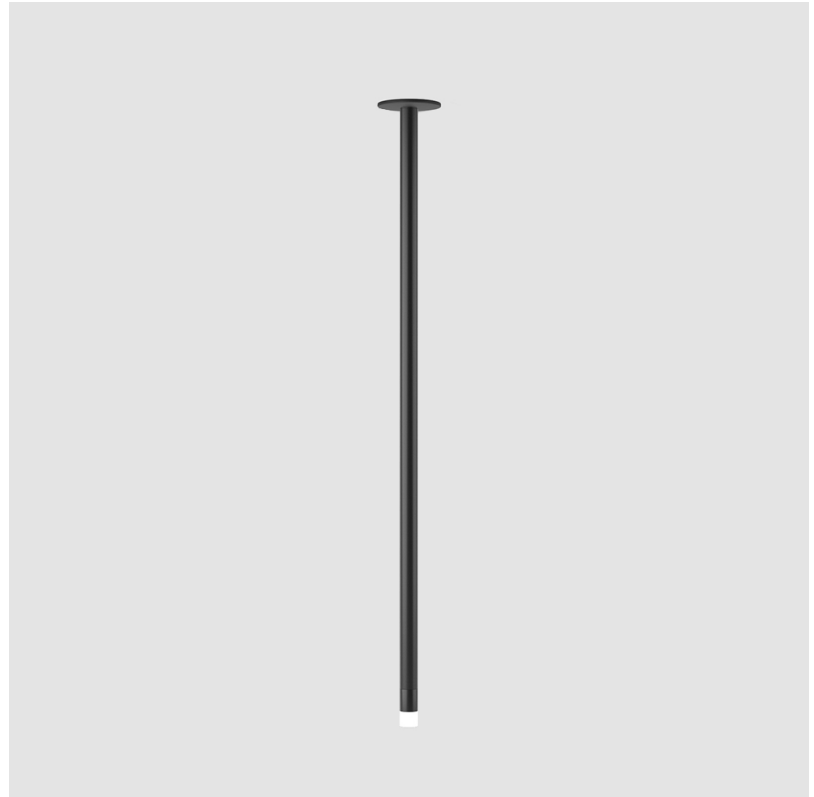

## METROPOLIS MONOPOINT HALO SURFACE

D202007-

PROJECT

TYPE

SPECIFIER

QUANTITY

DATE



D

PROJECT \_\_\_\_\_

TYPE \_\_\_\_\_

SPECIFIER \_\_\_\_\_

QUANTITY \_\_\_\_\_

DATE \_\_\_\_\_

### Fixture Finish

Black - BLK

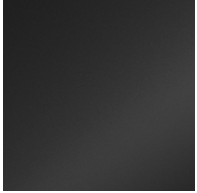

Bronze - BRZ

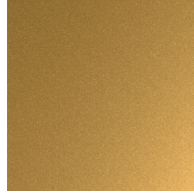

Industrial - IND



### Holder Finish

Black - BLK



Bronze - BRZ

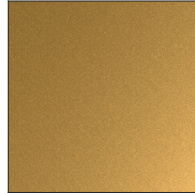

Industrial - IND

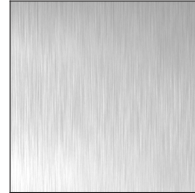

White - WHI



**Digital:** Not all screens are calibrated the same, and therefore, colors will appear differently between screens.

**Physical:** When texture is involved, there will be variations in color, character and tone within a product series and between product families.



|           |  |
|-----------|--|
| PROJECT   |  |
| TYPE      |  |
| SPECIFIER |  |
| QUANTITY  |  |
| DATE      |  |

### LEGEND

|  |   |  |  |  |  |
|--|---|--|--|--|--|
|  | floor-mounted   |  | pivotable  |  | special LED (upon request) RGB, RGBW, tunable, gold+, meat+, art+, fashion+                    |
|  | wall and ceiling: recessed and surface mounted            |  | rotating   |  | warm dim / natural dimming LED   |
|  | ceiling-mounted and wall-mounted                          |  | illuminate tilted  |  | rechargeable battery powered   |
|  | wall-mounted  |  | color of suspension cable                                    |  | fixture with natural vivid LED (upon request)  |
|  | omni-directional light distribution                       |  | length of suspension cable                                   |  | color rendering index  |
|  | direct light distribution                                 |  | reflector degree selection                                   |  | color temperature  |
|  | direct/indirect light distribution                        |  | super spot   |  | lumen (luminous flux)  |
|  | indirect light distribution                               |  | lens   |  | efficacy (lumens per watt)   |
|  | asymmetric light distribution                             |  | lens pack  |  | Unified Glare Rating (UGR) range from 5-40   |
|  | aura light distribution                                   |  | shine ring   |  | marine grade (AISI 316 stainless steel)  |
|  | round wall or ceiling cut-out                             |  | integrated shine ring with diffuser                          |  | walk on  |
|  | square wall or ceiling cut-out                            |  | free individual colors 01-29                                 |  | drive on   |
|  | the supplied jig specifies the cutout dimensions          |  | individual colors: 00 (free of charge), 01-25 (extra charge) |  | Dark Sky Compliance  |
|  | minimum distance (meters) lamp - object                   |  | luminaire part to be colored (F1)                            |  | Americans with Disabilities Act (less than 4" off the wall located between 27"-84" from floor) |
|  | recessed depth  |  | luminaire part to be colored (F2)                            |  | lamp protected against explosion   |
|  | ceiling thickness in mm                                   |  | luminaire part to be colored (F3)                            |  | blown glass using traditional methods by master glass blower                                   |
|  | ceiling thickness selection                               |  | luminaire part to be colored (F4)                            |  | acoustic material  |
|  | dimmable DP (phase), DV (0-10V), DD (dali), DS (step-dim) |  | luminaire part to be colored (F5)                            |  | protection class I, protection insulation  |
|  | included or excluded LED driver/transformer/control gear  |  | color of 3-circuit adaptor                                   |  | protection class II, protection insulation   |
|  | separately switchable                                     |  | indirect diffuser  |  | ETL Certified to UL and CSA Standards  |
|  | sensor  |  | direct diffuser  |  | UL Certified to UL and CSA Standards   |
|  | remote control  |  | ball-proof (upon request)                                    |  | CSA Certified to UL and CSA Standards  |
|  | available upon request                                    |  | accessory  |  | Certified for North American Standards   |

### IP RATING

|  |  |
|--|--|
|  | protected against ingress of solid bodies greater than 12.5mm (finger)   |
|  | protected against ingress of solid bodies greater than 2.5mm<br>protected against sprays of water up to 60 degrees from the vertical (rain)      |
|  | protected against ingress of solid bodies greater than 1mm (wire)<br>no protection against the ingress of moisture                               |
|  | protected against ingress of solid bodies greater than 1mm (wire)<br>protected against sprays of water up to 60 degrees from the vertical (rain) |
|  | protected against ingress of solid bodies greater than 1mm (wire)<br>protected against water splashed from all directions                        |
|  | protected against limited ingress of dust (wet rooms/covered outdoor areas)<br>protected against water splashed from all directions              |
|  | protected against ingress of dust<br>protected against jets of water   |
|  | protected against ingress of dust<br>protected against powerful jets of water or heavy seas  |
|  | protected against ingress of dust<br>protected against immersion of water between 15cm - 1m for 30 minutes                                       |
|  | protected against ingress of dust<br>protected against immersion of water under pressure for long periods  |

### IK RATING

|  |   |
|--|---|
|  | protected against 0.14 joules impact (equivalent to 0.25kg mass dropped from 56mm above the surface)  |
|  | protected against 0.2 joules impact (equivalent to 0.25kg mass dropped from 80mm above the surface)   |
|  | protected against 0.35 joules impact (equivalent to 0.25kg mass dropped from 140mm above the surface) |
|  | protected against 0.5 joules impact (equivalent to 0.25kg mass dropped from 200mm above the surface)  |
|  | protected against 0.7 joules impact (equivalent to 0.25kg mass dropped from 280mm above the surface)  |
|  | protected against 1 joules impact (equivalent to 0.25kg mass dropped from 400mm above the surface)    |
|  | protected against 2 joules impact (equivalent to 0.5kg mass dropped from 400mm above the surface)     |
|  | protected against 5 joules impact (equivalent to 1.7kg mass dropped from 300mm above the surface)     |
|  | protected against 10 joules impact (equivalent to 5.0kg mass dropped from 200mm above the surface)    |
|  | protected against 20 joules impact (equivalent to 5.0kg mass dropped from 400mm above the surface)    |