

MICRO RECESSED

E91141-

base number Color
Temperature

| | |
|-----------|-------|
| PROJECT | _____ |
| TYPE | _____ |
| SPECIFIER | _____ |
| QUANTITY | _____ |
| DATE | _____ |

1. To build a product code in our configurator select the specify button on the base model # product page
2. To build a manual product code on this datasheet choose from the options listed below in blue font and add the suffix to the base model #

GENERAL

Series: Micro
Brand: Platek
Division: Exterior
Mounting Type: Recessed
Mounting Location: In-Ground
Subcategory: Drive Over

PHYSICAL

Shape: Round
Diameter (mm): 95
Diameter (in): 3 3/4
Height (mm): 97
Height (in): 3 13/16
Light Distribution: Direct
Weight (kg): 0.55
Weight (lbs): 1.2
Load Resistance (kg): 2000
Load Resistance (lbs): 4409
Installation Requirement: Installation in sleeve set in concrete with a 20 - 30cm / 8 - 12" gravel drain bed
Diffuser: Clear tempered glass
Fixture Finish: SST
Fixture Material: Aluminum Die Cast
Cable Details: Supplied with 1 power cable 1m in length

ELECTRICAL

Lamp Type: LED
Input Wattage (W): 2.5
Total Output Wattage (W): 2
Driver Included: No
Driver Location: Remote
Driver Type: Constant Current - Universal
Driver Class: Class 2
Housing: (Not included - see components) L9A09600 allows for external driver (non-dimming - 120 / 277Vac [-25
Input Voltage (V): 120 - 277
Constant Current (MA): 700

Upon Request: External w/L9A09600 ONLY: Non-dimming 120 / 277Vac - min. operating temperature -25°C; if a lower operating temperature is required it must be REMOTE / (Not included - see components [IP65 or higher enclosure to be supplied by others]) Remote: (- 40°C) 0-10Vdc dimming (120 / 277Vac) / (-25°C) Phase dimming

LED

Number of LEDs: 1
Color Temperature (°K): 3000 / 4000
Max. Delivered Lumen (lm): 130 / 135
Nominal Lumen (lm): 250 / 260
CRI: >80 CRI
Lamp Life (hrs): 60000

OPTICAL

Optic°: Asymmetric
Beam Angle: 62

RATINGS AND CERTIFICATIONS

Certified By: Certified for North American Standards
IP Rating: IP68
IK Rating: IK10
Ene Rating: E0, E1, E2

Eng. Rating: E0, E1, E2, E3, E4, E5, E6, E7, E8, E9, E10, E11, E12, E13, E14, E15, E16, E17, E18, E19, E20, E21, E22, E23, E24, E25, E26, E27, E28, E29, E30, E31, E32, E33, E34, E35, E36, E37, E38, E39, E40, E41, E42, E43, E44, E45, E46, E47, E48, E49, E50, E51, E52, E53, E54, E55, E56, E57, E58, E59, E60, E61, E62, E63, E64, E65, E66, E67, E68, E69, E70, E71, E72, E73, E74, E75, E76, E77, E78, E79, E80, E81, E82, E83, E84, E85, E86, E87, E88, E89, E90, E91, E92, E93, E94, E95, E96, E97, E98, E99, E100

Upon Request: Higher Maximum Ambient Temperature of the existing Model #. For assistance on 'custom' specifications, contact zteam@zaneen.com. In a constant effort to supply the best product, we reserve the right to change specifications or materials without notice. The most recent specification sheets are found at zaneen.com



49mm 1 15/16"

49mm 1 15/16"

95mm 3 3/4"

95mm 3 3/4"

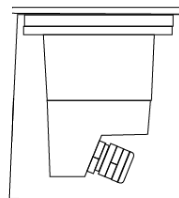
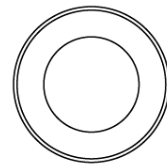
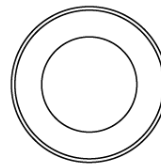

88mm 3 7/16"

97mm 3 13/16"



88mm 3 7/16"

97mm 3 13/16"

Slim Housing
L9A09500

Wide Housing
L9A09600



MICRO RECESSED

E9I141-

PROJECT

TYPE

SPECIFIER

QUANTITY

DATE



E

MICRO RECESSED

E91157-

base number Color Lens
 Temperature Options

- To build a product code in our configurator select the specify button on the base model # product page
- To build a manual product code on this datasheet choose from the options listed below in blue font and add the suffix to the base model #

GENERAL

Series: Micro
 Brand: Platek
 Division: Exterior
 Mounting Type: Recessed
 Mounting Location: In-Ground
 Subcategory: Drive Over

PHYSICAL

Shape: Round
 Diameter (mm): 95
 Diameter (in): 3 3/4
 Height (mm): 97
 Height (in): 3 13/16
 Light Distribution: Indirect
 Weight (kg): 0.55
 Weight (lbs): 1.2
 Load Resistance (kg): 2000
 Load Resistance (lbs): 4409
 Installation Requirement: Installation in sleeve set in concrete with a 20 - 30cm / 8 - 12" gravel drain bed
 Diffuser: Clear tempered glass
 Fixture Finish: SST
 Fixture Material: Aluminum Die Cast
 Cable Details: Supplied with 1 power cable 0.5m in length

ELECTRICAL

Lamp Type: LED
 Input Wattage (W): 5.9
 Total Output Wattage (W): 5
 Dimming: Non-Dimming / Phase Dimming (120Vac only) / 0-10V Dimming
 Driver Included: No
 Driver Location: Remote
 Driver Type: Constant Current - 120/277Vac
 Driver Class: Class 2
 Input Voltage (V): 120 - 277
 Constant Current (MA): 500

Upon Request: (Included) external w/L9A09600 only: Non-dimming 120 / 277Vac - min. operating temperature -25°C; if a lower operating temperature is required it must be REMOTE and is NOT included / (Not included - see components [IP65 or higher enclosure to be supplied by others]) Remote: (-40°C) 0-10Vdc dimming (120 / 277Vac) / (-40°C) Phase dimming @120Vac only

LED

Number of LEDs: 3
 Color Temperature (°K): 3000 / 4000
 Max. Delivered Lumen (lm): 435 - 465 / 450 - 485
 Nominal Lumen (lm): 570 / 600
 Lamp Life (hrs): 60000

OPTICAL

Optic°: 12 / 33 / 44

RATINGS AND CERTIFICATIONS

Certified By: Certified for North American Standards
 IP rating: IP68
 IK Rating: IK10
 Bug Rating: B0 U3 G0
 Upon Request: Higher Maximum Ambient Temperature

Zaneen Configurator: www.zaneen.com

Available for International specifications by adding 'INT' at the end of the existing Model #. For assistance on 'custom' specifications, contact zteam@zaneen.com. In a constant effort to supply the best product, we reserve the right to change specifications or materials without notice. The most recent specification sheets are found at zaneen.com

PROJECT

TYPE

SPECIFIER

QUANTITY

DATE



Ø95mm 3 3/4"

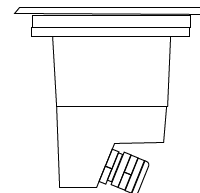
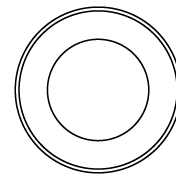

88mm 3 7/16"



MICRO RECESSED

E9I157-

PROJECT

TYPE

SPECIFIER

QUANTITY

DATE



| |
|-----------|
| PROJECT |
| TYPE |
| SPECIFIER |
| QUANTITY |
| DATE |

MICRO ROLL OVER RECESSED

E91560-

base number Color
Temperature

- To build a product code in our configurator select the specify button on the base model # product page
- To build a manual product code on this datasheet choose from the options listed below in blue font and add the suffix to the base model #

GENERAL

Series: Micro
Subseries: Micro Roll Over
Brand: Platek
Division: Exterior
Mounting Type: Recessed
Mounting Location: In-Ground
Subcategory: Marker

PHYSICAL

Shape: Round
Diameter (mm): 95
Diameter (in): 3 3/4
Height (mm): 114
Height (in): 4 1/2
Light Distribution: Uplight
Weight (kg): 0.4
Weight (lbs): 0.88
Load Resistance (kg): 2000
Load Resistance (lbs): 4409
Installation Requirement: Installation in sleeve set in concrete with a 20 - 30cm / 8 - 12" gravel drain bed
Screws: No visible screws
Diffuser: Clear tempered glass
Fixture Finish: SST
Fixture Material: Stainless Steel AISI 316L
Cable Details: Supplied with 1 power cable 0.5m in length

ELECTRICAL

Lamp Type: LED
Input Wattage (W): 2.9
Total Output Wattage (W): 1.5
Driver Included: No
Driver Location: Remote
Driver Type: Constant Current - Universal
Input Voltage (V): 120 - 277
Constant Current (MA): 350
Upon Request: (Not included - see components [IP65 or higher enclosure to be supplied by others]) 0-10Vdc dimming / Phase dimming / Non-dimming 120/277Vac

LED

Number of LEDs: 1
Color Temperature (°K): 3000 / 4000
Max. Delivered Lumen (lm): 15 / 16
Nominal Lumen (lm): 190 / 200
CRI: >80 CRI
Lamp Life (hrs): 60000

OPTICAL

Optic°: 1 Opening

RATINGS AND CERTIFICATIONS

Certified By: Certified for North American Standards
IP rating: IP68
IK Rating: IK10
Bug Rating: B0 U1 G0
Marine Grade: Stainless Steel AISI 316L
Upon Request: Higher Maximum Ambient Temperature



MICRO ROLL OVER RECESSED

E9I560-

| | |
|-----------|-------|
| PROJECT | _____ |
| TYPE | _____ |
| SPECIFIER | _____ |
| QUANTITY | _____ |
| DATE | _____ |

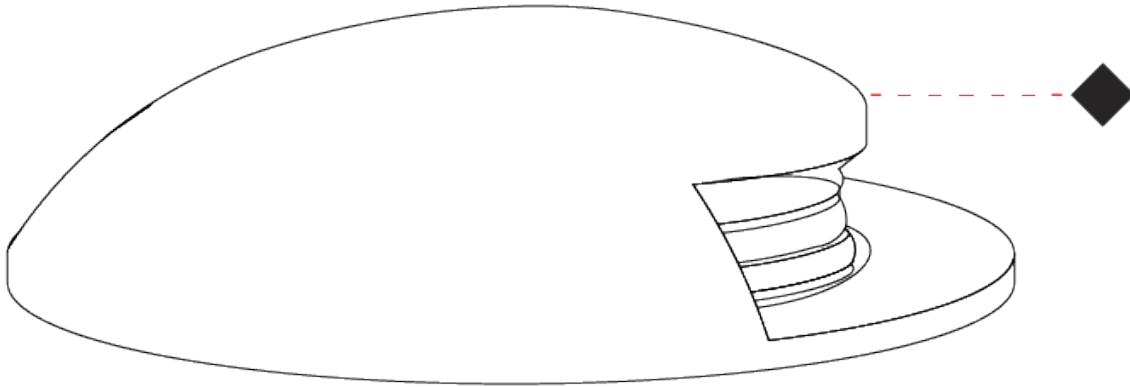

| |
|-----------|
| PROJECT |
| TYPE |
| SPECIFIER |
| QUANTITY |
| DATE |

MICRO ROLL OVER RECESSED

E9I561-

base number Color
 Temperature

- To build a product code in our configurator select the specify button on the base model # product page
- To build a manual product code on this datasheet choose from the options listed below in blue font and add the suffix to the base model #

GENERAL

Series: Micro
 Subseries: Micro Roll Over
 Brand: Platek
 Division: Exterior
 Mounting Type: Recessed
 Mounting Location: In-Ground
 Subcategory: Marker

PHYSICAL

Shape: Round
 Diameter (mm): 95
 Diameter (in): 3 3/4
 Height (mm): 114
 Height (in): 4 1/2
 Light Distribution: Uplight
 Weight (kg): 0.4
 Weight (lbs): 0.88
 Load Resistance (kg): 2000
 Load Resistance (lbs): 4409
 Installation Requirement: Installation in sleeve set in concrete with a 20 - 30cm / 8 - 12" gravel drain bed
 Screws: No visible screws
 Diffuser: Clear tempered glass
 Fixture Finish: SST
 Fixture Material: Stainless Steel AISI 316L
 Cable Details: Supplied with 1 power cable 0.5m in length

ELECTRICAL

Lamp Type: LED
 Input Wattage (W): 2.9
 Total Output Wattage (W): 1.5
 Driver Included: No
 Driver Location: Remote
 Driver Type: Constant Current - Universal
 Input Voltage (V): 120 - 277
 Constant Current (MA): 350
 Upon Request: (Not included - see components [IP65 or higher enclosure to be supplied by others]) 0-10Vdc dimming / Phase dimming / Non-dimming 120/277Vac

LED

Number of LEDs: 1
 Color Temperature (°K): 3000 / 4000
 Max. Delivered Lumen (lm): 35 / 37
 Nominal Lumen (lm): 190 / 200
 CRI: >80 CRI
 Lamp Life (hrs): 60000

OPTICAL

Optic°: 2 Openings

RATINGS AND CERTIFICATIONS

Certified By: Certified for North American Standards
 IP rating: IP68
 IK Rating: IK10
 Bug Rating: B0 U1 G0
 Marine Grade: Stainless Steel AISI 316L
 Upon Request: Higher Maximum Ambient Temperature

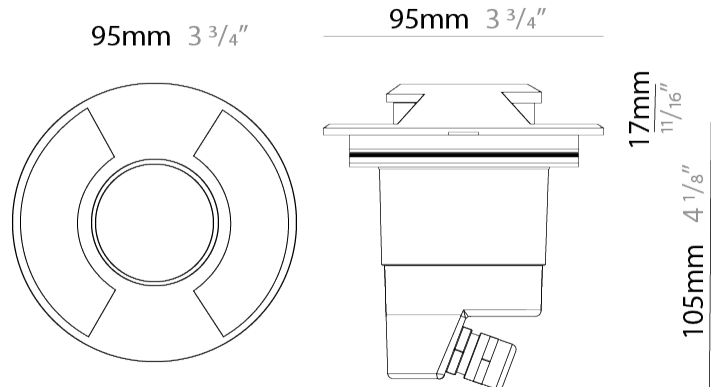

MICRO ROLL OVER RECESSED

E9I561-

| | |
|-----------|-------|
| PROJECT | _____ |
| TYPE | _____ |
| SPECIFIER | _____ |
| QUANTITY | _____ |
| DATE | _____ |



MICRO RECESSED

E91564-

base number Color Lens
Temperature Options

- To build a product code in our configurator select the specify button on the base model # product page
- To build a manual product code on this datasheet choose from the options listed below in blue font and add the suffix to the base model #

GENERAL

Series: Micro
Brand: Platek
Division: Exterior
Mounting Type: Recessed
Mounting Location: In-Ground
Subcategory: Drive Over

PHYSICAL

Shape: Round
Diameter (mm): 95
Diameter (in): 3 3/4
Height (mm): 88
Height (in): 3 1/2
Light Distribution: Uplight
Weight (kg): 0.5
Weight (lbs): 1.1
Load Resistance (kg): 2000
Load Resistance (lbs): 4409
Installation Requirement: Installation in sleeve set in concrete with a 20 - 30cm / 8 - 12" gravel drain bed
Screws: No visible screws
Diffuser: Clear tempered glass
Fixture Finish: SST
Fixture Material: Stainless Steel AISI 316L
Cable Details: Supplied with 1 power cable 5m in length

ELECTRICAL

Lamp Type: LED
Input Wattage (W): 5.9 / RGBW 6
Total Output Wattage (W): 5 / RGBW 6
Driver Included: No
Driver Location: Remote
Driver Type: White LED - Constant Voltage - 120 / 277Vac RGBW - Constant Current - Universal
Housing: (Not included - see components) L9A09600 allows for external driver (non-dimming - 120 / 277Vac [-30
Input Voltage (V): 120 - 277
Output Voltage (V): 24
Upon Request: (Not included - see components [IP65 or higher enclosure to be supplied by others]) 0-10Vdc dimming / Phase dimming / Non-dimming 120/277Vac / DMX

LED

Number of LEDs: 3 / RGBW 4
Color Temperature (°K): 3000 / 4000 / RGBW
Max. Delivered Lumen (lm): 435 - 465 / 450 - 485
Nominal Lumen (lm): 570 / 600
CRI: >80 CRI
Lamp Life (hrs): 60000

OPTICAL

Optic°: 12 / 33 / 44

RATINGS AND CERTIFICATIONS

Certified By: Certified for North American Standards
IP rating: IP68
IK Rating: IK10
Bug Rating: B0 U3 G0
Marine Grade: Stainless Steel AISI 316L
Upon Request: Higher Maximum Ambient Temperature

Copyright © 2022, 1-800-288-2363, E-111-347-8310, www.zaneen.com

Available for International specifications by adding 'INT' at the end of the existing Model #. For assistance on 'custom' specifications, contact zteam@zaneen.com. In a constant effort to supply the best product, we reserve the right to change specifications or materials without notice. The most recent specification sheets are found at zaneen.com

| |
|-----------|
| PROJECT |
| TYPE |
| SPECIFIER |
| QUANTITY |
| DATE |



49mm 1 15/16"

95mm 3 3/4"

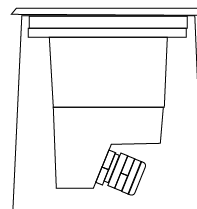
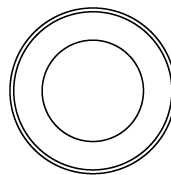

Slim Housing
L9A09500



49mm 1 15/16"

95mm 3 3/4"

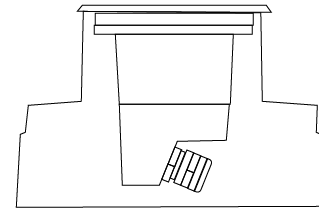
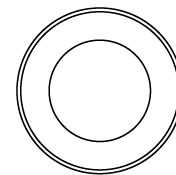

Wide Housing
L9A09500

88mm 3 7/16"

97mm 3 13/16"

88mm 3 7/16"

97mm 3 13/16"

MICRO RECESSED

E9I564-

PROJECT

TYPE

SPECIFIER

QUANTITY

DATE



MICRO RECESSED

E91570-

base number Color Lens
Temperature Options

- To build a product code in our configurator select the specify button on the base model # product page
- To build a manual product code on this datasheet choose from the options listed below in blue font and add the suffix to the base model #

GENERAL

Series: Micro
Brand: Platek
Division: Exterior
Mounting Type: Recessed
Mounting Location: In-Ground
Subcategory: Drive Over

PHYSICAL

Shape: Round
Diameter (mm): 95
Diameter (in): 3 3/4
Height (mm): 88
Height (in): 3 1/2
Light Distribution: Uplight
Weight (kg): 0.5
Weight (lbs): 1.1
Load Resistance (kg): 2000
Load Resistance (lbs): 4409
Installation Requirement: Installation in sleeve set in concrete with a 20 - 30cm / 8 - 12" gravel drain bed
Screws: No visible screws
Diffuser: Clear tempered glass
Fixture Finish: SST
Fixture Material: Stainless Steel AISI 316L
Cable Details: Supplied with 1 power cable 0.5m in length

ELECTRICAL

Lamp Type: LED
Input Wattage (W): 5.9
Total Output Wattage (W): 5
Driver Included: No
Driver Location: Remote
Driver Type: Constant Voltage - Universal
Driver Class: Class 2
Housing: (Not included - see components) L9A09600 allows for external driver (non-dimming - 120 / 277Vac - [-
Input Voltage (V): 120 - 277
Constant Current (MA): 500
Upon Request: (Included) Integral w/L9A09600 ONLY - Non-dimming 120 / 277Vac / (Not included - see components [IP65 or higher enclosure to be supplied by others]) Remote: 0-10Vdc dimming / Phase dimming @120Vac only

LED

Number of LEDs: 3
Color Temperature (°K): 3000 / 4000
Max. Delivered Lumen (lm): 440 - 465 / 450 - 485
Nominal Lumen (lm): 570 / 600
CRI: >80 CRI
Lamp Life (hrs): 60000

OPTICAL

Optic°: 12 / 33 / 44

RATINGS AND CERTIFICATIONS

Certified By: Certified for North American Standards
IP rating: IP68
IK Rating: IK10
Bug Rating: B0 U3 G0

Material: Stainless Steel AISI 316L
Zaneen® © 2024, T 1900 380 2853, F 416-247-9319, www.zaneen.com

Available for international specifications by adding "INT" at the end of the existing Model #. For assistance on 'custom' specifications, contact zteam@zaneen.com.
Upon Request: Higher Maximum Ambient Temperature
In a constant effort to supply the best product, we reserve the right to change specifications or materials without notice. The most recent specification sheets are found at zaneen.com

| |
|-----------|
| PROJECT |
| TYPE |
| SPECIFIER |
| QUANTITY |
| DATE |



49mm 1 15/16"

95mm 3 3/4"

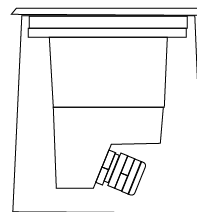

88mm 3 7/16"

97mm 3 13/16"

Slim Housing
L9A09500

49mm 1 15/16"

95mm 3 3/4"

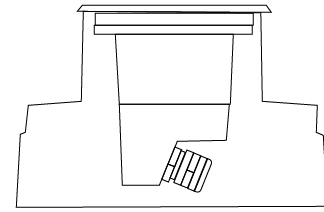
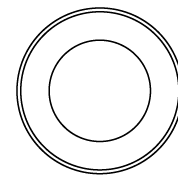

88mm 3 7/16"

97mm 3 13/16"

Wide Housing
L9A09500



MICRO RECESSED

E9I570-

PROJECT

TYPE

SPECIFIER

QUANTITY

DATE



MICRO RECESSED

E91630-

base number Lens Options

- To build a product code in our configurator select the specify button on the base model # product page
- To build a manual product code on this datasheet choose from the options listed below in blue font and add the suffix to the base model #

GENERAL

Series: Micro
 Brand: Platek
 Division: Exterior
 Mounting Type: Recessed
 Mounting Location: In-Ground
 Subcategory: Drive Over

PHYSICAL

Shape: Round
 Diameter (mm): 95
 Diameter (in): 3 3/4
 Height (mm): 97
 Height (in): 3 13/16
 Light Distribution: Direct
 Weight (kg): 0.55
 Weight (lbs): 1.2
 Load Resistance (kg): 2000
 Load Resistance (lbs): 4409
 Installation Requirement: Installation in sleeve set in concrete with a 20 - 30cm / 8 - 12" gravel drain bed
 Diffuser: Clear tempered glass
 Fixture Finish: SST
 Fixture Material: Aluminum Die Cast
 Cable Details: Supplied with 1 power cable 1m in length

ELECTRICAL

Lamp Type: LED
 Input Wattage (W): 6
 Total Output Wattage (W): 6
 Dimming: Bluetooth technology or DMX
 Control Gear: DMX
 Driver Included: No
 Driver Location: Remote
 Driver Type: Constant Current - Universal
 Driver Class: Class 2
 Input Voltage (V): 120 - 277
 Constant Current (MA): 500

LED

Number of LEDs: 4
 Color Temperature (°K): RGBW
 CRI: >80 CRI
 Lamp Life (hrs): 60000
 Special LEDs offerings: RGBW

OPTICAL

Optic°: 12 / 33 / 44

RATINGS AND CERTIFICATIONS

Certified By: Certified for North American Standards
 IP rating: IP68
 IK Rating: IK10
 Bug Rating: B0 U5 G0
 Upon Request: Higher Maximum Ambient Temperature

| |
|-----------|
| PROJECT |
| TYPE |
| SPECIFIER |
| QUANTITY |
| DATE |



49mm 1 15/16"

95mm 3 3/4"



49mm 1 15/16"

95mm 3 3/4"

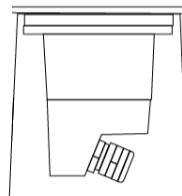
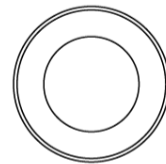

88mm 3 7/16"

97mm 3 13/16"

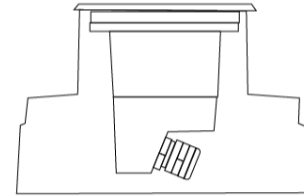

88mm 3 7/16"

97mm 3 13/16"

Slim Housing
L9A09500

Wide Housing
L9A09600



MICRO RECESSED

E9I630-

PROJECT

TYPE

SPECIFIER

QUANTITY

DATE



MICRO RECESSED

E9Q042-

base number Color Lens
 Temperature Options

- To build a product code in our configurator select the specify button on the base model # product page
- To build a manual product code on this datasheet choose from the options listed below in blue font and add the suffix to the base model #

GENERAL

Series: Micro
 Brand: Platek
 Division: Exterior
 Mounting Type: Recessed
 Mounting Location: Ceiling
 Subcategory: Downlight

PHYSICAL

Shape: Round
 Diameter (mm): 95
 Diameter (in): 3 ¾
 Height (mm): 88
 Height (in): 3 ½
 Ceiling Thickness (mm): 10 - 20
 Ceiling Thickness (in): 3/8 - 13/16
 Light Distribution: Downlight
 Weight (kg): 0.55
 Weight (lbs): 1.2
 Load Resistance (kg): 2000
 Load Resistance (lbs): 4409
 Screws: No visible screws
 Diffuser: Clear tempered glass
 Fixture Finish: SST
 Fixture Material: Aluminum Die Cast
 Cable Details: Supplied with power cable 2 x 1,00 mm2 in length
 Cut-out Measurements: 80mm / 3 1/8" diameter

ELECTRICAL

Lamp Type: LED
 Input Wattage (W): 5.9 / 2
 Total Output Wattage (W): 5 / 2
 Driver Included: No
 Driver Location: Remote
 Driver Type: Constant Current - 120 / 277Vac
 Driver Class: Class 2
 Input Voltage (V): 120 - 277
 Constant Current (MA): (5W) 350 / (2W) 700
 Upon Request: (Not included - see components [IP65 or higher enclosure to be supplied by others]) 0-10Vdc dimming / Phase dimming / Non-dimming 120/277Vac

LED

Number of LEDs: 3 / 1
 Color Temperature (°K): 3000 / 4000
 Max. Delivered Lumen (lm): 130 - 465 / 135 - 485
 Nominal Lumen (lm): 570 / 600
 CRI: >80 CRI
 Lamp Life (hrs): 60000

OPTICAL

Optic°: 12 / 33 / 44 / ASY

RATINGS AND CERTIFICATIONS

Certified By: Certified for North American Standards
 IP rating: IP68
 IK Rating: IK10
 Bug Rating: B1 U0 G0
 Upon Request: Higher Maximum Ambient Temperature

| |
|-----------|
| PROJECT |
| TYPE |
| SPECIFIER |
| QUANTITY |
| DATE |



95mm 3 ¾"

49mm 1 15/16"

88mm 3 7/16"

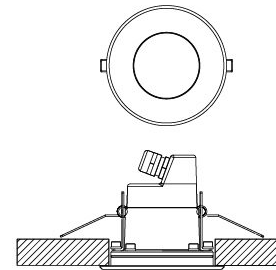

MICRO RECESSED

E9Q042-

PROJECT

TYPE

SPECIFIER

QUANTITY

DATE

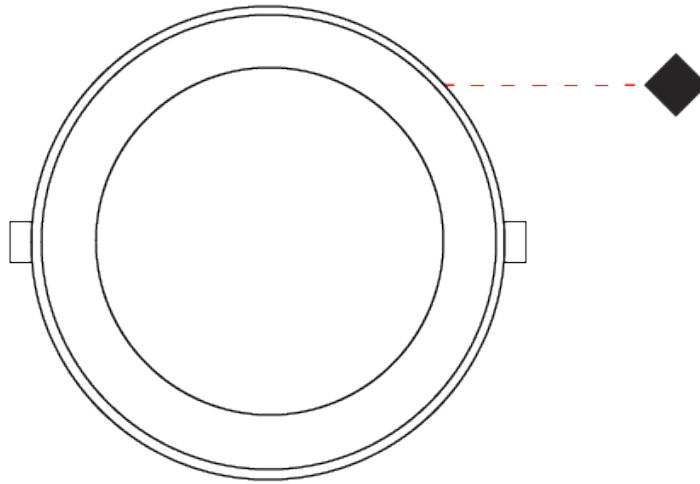

...



MICRO RECESSED

E9Q108-

base number Lens
Options

1. To build a product code in our configurator select the specify button on the base model # product page
2. To build a manual product code on this datasheet choose from the options listed below in blue font and add the suffix to the base model #

GENERAL

Series: Micro
Brand: Platek
Division: Exterior
Mounting Type: Recessed
Mounting Location: Ceiling
Subcategory: Downlight

PHYSICAL

Shape: Round
Diameter (mm): 95
Diameter (in): 3 ¾
Height (mm): 88
Height (in): 3 ½
Ceiling Thickness (mm): 10 - 20
Ceiling Thickness (in): 3/8 - 13/16
Light Distribution: Downlight
Weight (kg): 0.55
Weight (lbs): 1.2
Load Resistance (kg): 2000
Load Resistance (lbs): 4409
Screws: No visible screws
Diffuser: Clear tempered glass
Fixture Finish: SST
Fixture Material: Aluminum Die Cast
Cable Details: Supplied with power cable 2 x 1,00 mm2 in length
Cut-out Measurements: 80mm / 3 1/8" diameter

ELECTRICAL

Lamp Type: LED
Input Wattage (W): 6
Total Output Wattage (W): 6
Dimming: Bluetooth technology or DMX
Control Gear: DMX
Driver Included: No
Driver Location: Remote
Driver Type: Constant Current - 120 / 277Vac
Driver Class: Class 2
Input Voltage (V): 120 - 277
Constant Current (MA): 500

LED

Number of LEDs: 4
Color Temperature (°K): RGBW
CRI: >80 CRI
Lamp Life (hrs): 60000
Special LEDs offerings: RGBW

OPTICAL

Optic°: 12 / 33 / 44

RATINGS AND CERTIFICATIONS

Certified By: Certified for North American Standards
IP rating: IP68
IK Rating: IK10
Bug Rating: B1 U0 G0
Upon Request: Higher Maximum Ambient Temperature

| | |
|-----------|-------|
| PROJECT | _____ |
| TYPE | _____ |
| SPECIFIER | _____ |
| QUANTITY | _____ |
| DATE | _____ |



95mm 3 ¾"

49mm 1 15/16"

88mm 3 7/16"

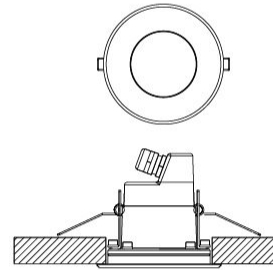

MICRO RECESSED

E9Q108-

PROJECT

TYPE

SPECIFIER

QUANTITY

DATE



...



PROJECT

TYPE

SPECIFIER

QUANTITY

DATE

Fixture Finish

Stainless Steel Inox - SST



Digital: Not all screens are calibrated the same, and therefore, colors will appear differently between screens.

Physical: When texture is involved, there will be variations in color, character and tone within a product series and between product families.



| | |
|-----------|--|
| PROJECT | |
| TYPE | |
| SPECIFIER | |
| QUANTITY | |
| DATE | |

LEGEND

| | | |
|---|--|--|
| floor-mounted | pivotal | special LED (upon request) RGB, RGBW, tunable, gold+, meat+, art+, fashion+ |
| wall and ceiling: recessed and surface mounted | rotating | warm dim / natural dimming LED |
| ceiling-mounted and wall-mounted | illuminate tilted | rechargeable battery powered |
| wall-mounted | color of suspension cable | fixture with natural vivid LED (upon request) |
| omni-directional light distribution | length of suspension cable | color rendering index |
| direct light distribution | reflector degree selection | color temperature |
| direct/indirect light distribution | super spot | lumen (luminous flux) |
| indirect light distribution | lens | efficacy (lumens per watt) |
| asymmetric light distribution | lens pack | Unified Glare Rating (UGR) range from 5-40 |
| aura light distribution | shine ring | marine grade (AISI 316 stainless steel) |
| round wall or ceiling cut-out | integrated shine ring with diffuser | walk on |
| square wall or ceiling cut-out | free individual colors 01-29 | drive on |
| the supplied jig specifies the cutout dimensions | individual colors: 00 (free of charge), 01-25 (extra charge) | Dark Sky Compliance |
| minimum distance (meters) lamp - object | luminaire part to be colored (F1) | Americans with Disabilities Act (less than 4" off the wall located between 27"-84" from floor) |
| recessed depth | luminaire part to be colored (F2) | lamp protected against explosion |
| ceiling thickness in mm | luminaire part to be colored (F3) | blown glass using traditional methods by master glass blower |
| ceiling thickness selection | luminaire part to be colored (F4) | acoustic material |
| dimmable DP (phase), DV (0-10V), DD (dali), DS (step-dim) | luminaire part to be colored (F5) | protection class I, protection insulation |
| included or excluded LED driver/transformer/control gear | color of 3-circuit adaptor | protection class II, protection insulation |
| separately switchable | indirect diffuser | ETL Certified to UL and CSA Standards |
| sensor | direct diffuser | UL Certified to UL and CSA Standards |
| remote control | ball-proof (upon request) | CSA Certified to UL and CSA Standards |
| available upon request | accessory | Certified for North American Standards |

IP RATING

| | |
|------|--|
| IP20 | protected against ingress of solid bodies greater than 12.5mm (finger) |
| IP33 | protected against ingress of solid bodies greater than 2.5mm protected against sprays of water up to 60 degrees from the vertical (rain) |
| IP40 | protected against ingress of solid bodies greater than 1mm (wire) no protection against the ingress of moisture |
| IP43 | protected against ingress of solid bodies greater than 1mm (wire) protected against sprays of water up to 60 degrees from the vertical (rain) |
| IP44 | protected against ingress of solid bodies greater than 1mm (wire) protected against water splashed from all directions |
| IP54 | protected against limited ingress of dust (wet rooms/covered outdoor areas) protected against water splashed from all directions |
| IP65 | protected against ingress of dust protected against jets of water |
| IP66 | protected against ingress of dust protected against powerful jets of water or heavy seas |
| IP67 | protected against ingress of dust protected against immersion of water between 15cm - 1m for 30 minutes |
| IP68 | protected against ingress of dust protected against immersion of water under pressure for long periods |

IK RATING

| | |
|------|---|
| IK01 | protected against 0.14 joules impact (equivalent to 0.25kg mass dropped from 56mm above the surface) |
| IK02 | protected against 0.2 joules impact (equivalent to 0.25kg mass dropped from 80mm above the surface) |
| IK03 | protected against 0.35 joules impact (equivalent to 0.25kg mass dropped from 140mm above the surface) |
| IK04 | protected against 0.5 joules impact (equivalent to 0.25kg mass dropped from 200mm above the surface) |
| IK05 | protected against 0.7 joules impact (equivalent to 0.25kg mass dropped from 280mm above the surface) |
| IK06 | protected against 1 joules impact (equivalent to 0.25kg mass dropped from 400mm above the surface) |
| IK07 | protected against 2 joules impact (equivalent to 0.5kg mass dropped from 400mm above the surface) |
| IK08 | protected against 5 joules impact (equivalent to 1.7kg mass dropped from 300mm above the surface) |
| IK09 | protected against 10 joules impact (equivalent to 5.0kg mass dropped from 200mm above the surface) |
| IK10 | protected against 20 joules impact (equivalent to 5.0kg mass dropped from 400mm above the surface) |