

## MICRO RECESSED

### E91141-

base number Color  
 Temperature

- To build a product code in our configurator select the specify button on the base model # product page
- To build a manual product code on this datasheet choose from the options listed below in blue font and add the suffix to the base model #

#### GENERAL

Series: Micro  
 Brand: Platek  
 Division: Exterior  
 Mounting Type: Recessed  
 Mounting Location: In-Ground  
 Subcategory: Drive Over

#### PHYSICAL

Shape: Round  
 Diameter (mm): 95  
 Diameter (in): 3 3/4  
 Height (mm): 97  
 Height (in): 3 13/16  
 Light Distribution: Direct  
 Weight (kg): 0.55  
 Weight (lbs): 1.2  
 Load Resistance (kg): 2000  
 Load Resistance (lbs): 4409  
 Installation Requirement: Installation in sleeve set in concrete with a 20 - 30cm / 8 - 12" gravel drain bed  
 Diffuser: Clear tempered glass  
 Fixture Finish: SST  
 Fixture Material: Aluminum Die Cast  
 Cable Details: Supplied with 1 power cable 1m in length

#### ELECTRICAL

Lamp Type: LED  
 Input Wattage (W): 2.5  
 Total Output Wattage (W): 2  
 Driver Included: No  
 Driver Location: Remote  
 Driver Type: Constant Current - Universal  
 Driver Class: Class 2  
 Housing: (Not included - see components) L9A09600 allows for external driver (non-dimming - 120 / 277Vac [-25  
 Input Voltage (V): 120 - 277  
 Constant Current (MA): 700  
 Upon Request: External w/L9A09600 ONLY: Non-dimming 120 / 277Vac - min. operating temperature -25°C; if a lower operating temperature is required it must be REMOTE / (Not included - see components [IP65 or higher enclosure to be supplied by others]) Remote: (- 40°C) 0-10Vdc dimming (120 / 277Vac) / (-25°C) Phase dimming

#### LED

Number of LEDs: 1  
 Color Temperature (°K): 3000 / 4000  
 Max. Delivered Lumen (lm): 130 / 135  
 Nominal Lumen (lm): 250 / 260  
 CRI: >80 CRI  
 Lamp Life (hrs): 60000

#### OPTICAL

Optic°: Asymmetric  
 Beam Angle: 62

#### RATINGS AND CERTIFICATIONS

Certified By: Certified for North American Standards  
 IP Rating: IP68  
 IK Rating: IK10

Engineering: 60.0360, T 1800-388-3382, F 416-247-9319, www.zaneen.com

Upon Request: Higher Maximum Ambient Temperature of the existing Model #. For assistance on 'custom' specifications, contact zteam@zaneen.com. In a constant effort to supply the best product, we reserve the right to change specifications or materials without notice. The most recent specification sheets are found at zaneen.com



49mm 1 15/16"

49mm 1 15/16"

95mm 3 3/4"

95mm 3 3/4"

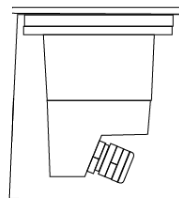
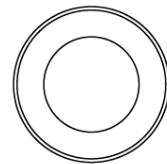
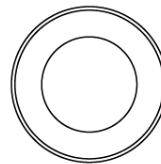

88mm 3 7/16"

97mm 3 13/16"

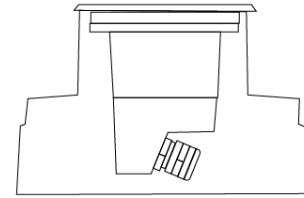

88mm 3 7/16"

97mm 3 13/16"

Slim Housing  
L9A09500

Wide Housing  
L9A09600



## MICRO RECESSED

E91141-

PROJECT

TYPE

SPECIFIER

QUANTITY

DATE



## MICRO RECESSED

### E91157-

base number Color Lens  
Temperature Options

- To build a product code in our configurator select the specify button on the base model # product page
- To build a manual product code on this datasheet choose from the options listed below in blue font and add the suffix to the base model #

#### GENERAL

Series: Micro  
Brand: Platek  
Division: Exterior  
Mounting Type: Recessed  
Mounting Location: In-Ground  
Subcategory: Drive Over

#### PHYSICAL

Shape: Round  
Diameter (mm): 95  
Diameter (in): 3 3/4  
Height (mm): 97  
Height (in): 3 13/16  
Light Distribution: Indirect  
Weight (kg): 0.55  
Weight (lbs): 1.2  
Load Resistance (kg): 2000  
Load Resistance (lbs): 4409  
Installation Requirement: Installation in sleeve set in concrete with a 20 - 30cm / 8 - 12" gravel drain bed  
Diffuser: Clear tempered glass  
Fixture Finish: SST  
Fixture Material: Aluminum Die Cast  
Cable Details: Supplied with 1 power cable 0.5m in length

#### ELECTRICAL

Lamp Type: LED  
Input Wattage (W): 5.9  
Total Output Wattage (W): 5  
Dimming: Non-Dimming / Phase Dimming (120Vac only) / 0-10V Dimming  
Driver Included: No  
Driver Location: Remote  
Driver Type: Constant Current - 120/277Vac  
Driver Class: Class 2  
Input Voltage (V): 120 - 277  
Constant Current (MA): 500

Upon Request: (Included) external w/L9A09600 only: Non-dimming 120 / 277Vac - min. operating temperature -25°C; if a lower operating temperature is required it must be REMOTE and is NOT included / (Not included - see components [IP65 or higher enclosure to be supplied by others]) Remote: (-40°C) 0-10Vdc dimming (120 / 277Vac) / (-40°C) Phase dimming @120Vac only

#### LED

Number of LEDs: 3  
Color Temperature (°K): 3000 / 4000  
Max. Delivered Lumen (lm): 435 - 465 / 450 - 485  
Nominal Lumen (lm): 570 / 600  
Lamp Life (hrs): 60000

#### OPTICAL

Optic°: 12 / 33 / 44

#### RATINGS AND CERTIFICATIONS

Certified By: Certified for North American Standards  
IP rating: IP68  
IK Rating: IK10  
Bug Rating: B0 U3 G0  
Upon Request: Higher Maximum Ambient Temperature

Zaneen Contact: 01878 333 822 | [www.zaneen.com](http://www.zaneen.com)

Available for International specifications by adding 'INT' at the end of the existing Model #. For assistance on 'custom' specifications, contact [zteam@zaneen.com](mailto:zteam@zaneen.com). In a constant effort to supply the best product, we reserve the right to change specifications or materials without notice. The most recent specification sheets are found at [zaneen.com](http://zaneen.com)

PROJECT

TYPE

SPECIFIER

QUANTITY

DATE



Ø95mm 3 3/4"

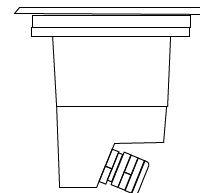
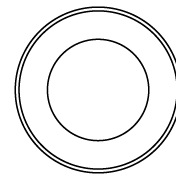

88mm 3 7/16"



## MICRO RECESSED

E9I157-

PROJECT

TYPE

SPECIFIER

QUANTITY

DATE



PROJECT	_____
TYPE	_____
SPECIFIER	_____
QUANTITY	_____
DATE	_____

## MICRO ROLL OVER RECESSED

### E91560-

base number          Color           
 Temperature         

- To build a product code in our configurator select the specify button on the base model # product page
- To build a manual product code on this datasheet choose from the options listed below in blue font and add the suffix to the base model #

#### GENERAL

Series: Micro  
 Subseries: Micro Roll Over  
 Brand: Platek  
 Division: Exterior  
 Mounting Type: Recessed  
 Mounting Location: In-Ground  
 Subcategory: Marker

#### PHYSICAL

Shape: Round  
 Diameter (mm): 95  
 Diameter (in): 3 3/4  
 Height (mm): 114  
 Height (in): 4 1/2  
 Light Distribution: Uplight  
 Weight (kg): 0.4  
 Weight (lbs): 0.88  
 Load Resistance (kg): 2000  
 Load Resistance (lbs): 4409  
 Installation Requirement: Installation in sleeve set in concrete with a 20 - 30cm / 8 - 12" gravel drain bed  
 Screws: No visible screws  
 Diffuser: Clear tempered glass  
 Fixture Finish: SST  
 Fixture Material: Stainless Steel AISI 316L  
 Cable Details: Supplied with 1 power cable 0.5m in length

#### ELECTRICAL

Lamp Type: LED  
 Input Wattage (W): 2.9  
 Total Output Wattage (W): 1.5  
 Driver Included: No  
 Driver Location: Remote  
 Driver Type: Constant Current - Universal  
 Input Voltage (V): 120 - 277  
 Constant Current (MA): 350  
 Upon Request: (Not included - see components [IP65 or higher enclosure to be supplied by others]) 0-10Vdc dimming / Phase dimming / Non-dimming 120/277Vac

#### LED

Number of LEDs: 1  
 Color Temperature (°K): 3000 / 4000  
 Max. Delivered Lumen (lm): 15 / 16  
 Nominal Lumen (lm): 190 / 200  
 CRI: >80 CRI  
 Lamp Life (hrs): 60000

#### OPTICAL

Optic°: 1 Opening

#### RATINGS AND CERTIFICATIONS

Certified By: Certified for North American Standards  
 IP rating: IP68  
 IK Rating: IK10  
 Bug Rating: B0 U1 G0  
 Marine Grade: Stainless Steel AISI 316L  
 Upon Request: Higher Maximum Ambient Temperature

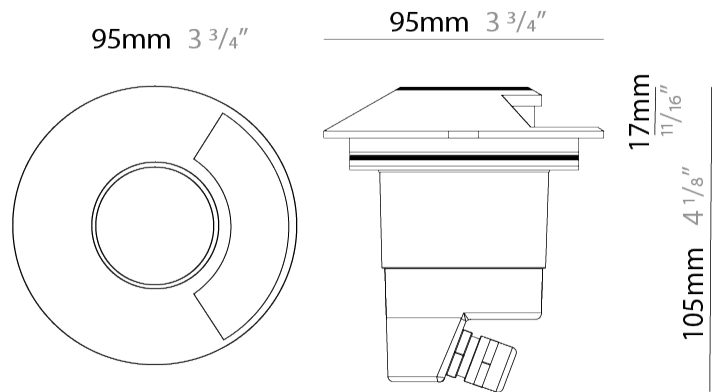

## MICRO ROLL OVER RECESSED

E9I560-

PROJECT

TYPE

SPECIFIER

QUANTITY

DATE

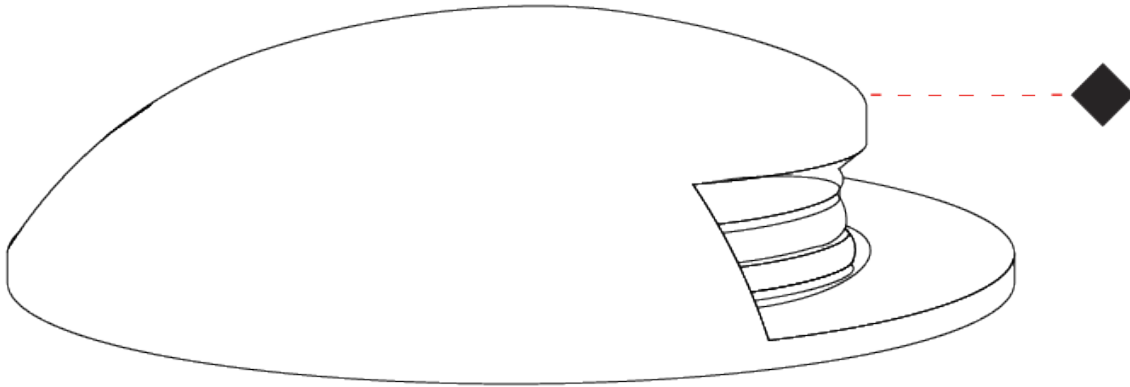

E

## MICRO ROLL OVER RECESSED

### E9I561-

base number            Color             
 Temperature           

- To build a product code in our configurator select the specify button on the base model # product page
- To build a manual product code on this datasheet choose from the options listed below in blue font and add the suffix to the base model #

#### GENERAL

Series: Micro  
 Subseries: Micro Roll Over  
 Brand: Platek  
 Division: Exterior  
 Mounting Type: Recessed  
 Mounting Location: In-Ground  
 Subcategory: Marker

#### PHYSICAL

Shape: Round  
 Diameter (mm): 95  
 Diameter (in): 3 3/4  
 Height (mm): 114  
 Height (in): 4 1/2  
 Light Distribution: Uplight  
 Weight (kg): 0.4  
 Weight (lbs): 0.88  
 Load Resistance (kg): 2000  
 Load Resistance (lbs): 4409  
 Installation Requirement: Installation in sleeve set in concrete with a 20 - 30cm / 8 - 12" gravel drain bed  
 Screws: No visible screws  
 Diffuser: Clear tempered glass  
 Fixture Finish: SST  
 Fixture Material: Stainless Steel AISI 316L  
 Cable Details: Supplied with 1 power cable 0.5m in length

#### ELECTRICAL

Lamp Type: LED  
 Input Wattage (W): 2.9  
 Total Output Wattage (W): 1.5  
 Driver Included: No  
 Driver Location: Remote  
 Driver Type: Constant Current - Universal  
 Input Voltage (V): 120 - 277  
 Constant Current (MA): 350  
 Upon Request: (Not included - see components [IP65 or higher enclosure to be supplied by others]) 0-10Vdc dimming / Phase dimming / Non-dimming 120/277Vac

#### LED

Number of LEDs: 1  
 Color Temperature (°K): 3000 / 4000  
 Max. Delivered Lumen (lm): 35 / 37  
 Nominal Lumen (lm): 190 / 200  
 CRI: >80 CRI  
 Lamp Life (hrs): 60000

#### OPTICAL

Optic°: 2 Openings

#### RATINGS AND CERTIFICATIONS

Certified By: Certified for North American Standards  
 IP rating: IP68  
 IK Rating: IK10  
 Bug Rating: B0 U1 G0  
 Marine Grade: Stainless Steel AISI 316L  
 Upon Request: Higher Maximum Ambient Temperature

PROJECT	_____
TYPE	_____
SPECIFIER	_____
QUANTITY	_____
DATE	_____

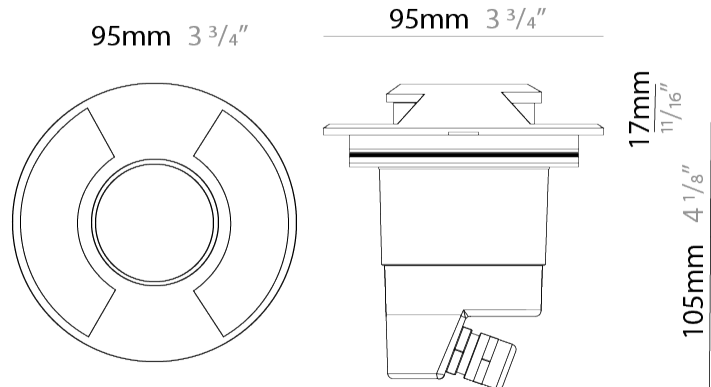

## MICRO ROLL OVER RECESSED

E9I561-

PROJECT	_____
TYPE	_____
SPECIFIER	_____
QUANTITY	_____
DATE	_____

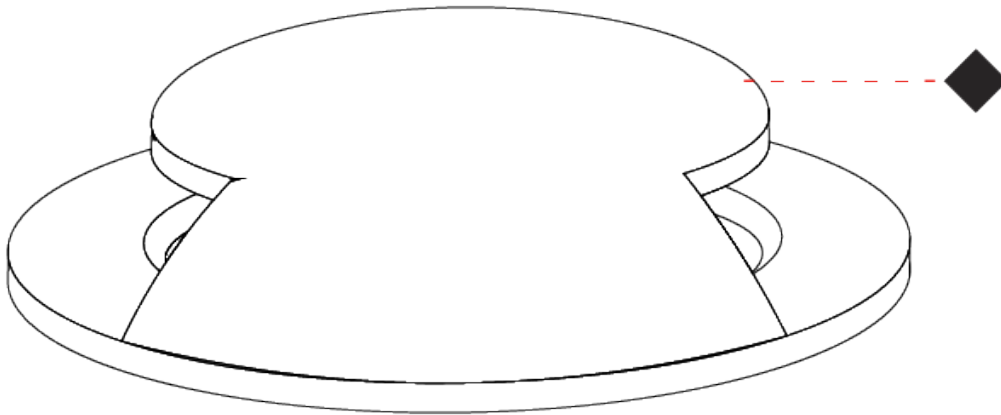



## MICRO RECESSED

### E91564-

base number    Color    Lens  
 Temperature    Options

- To build a product code in our configurator select the specify button on the base model # product page
- To build a manual product code on this datasheet choose from the options listed below in blue font and add the suffix to the base model #

#### GENERAL

Series: Micro  
 Brand: Platek  
 Division: Exterior  
 Mounting Type: Recessed  
 Mounting Location: In-Ground  
 Subcategory: Drive Over

#### PHYSICAL

Shape: Round  
 Diameter (mm): 95  
 Diameter (in): 3 3/4  
 Height (mm): 88  
 Height (in): 3 1/2  
 Light Distribution: Uplight  
 Weight (kg): 0.5  
 Weight (lbs): 1.1  
 Load Resistance (kg): 2000  
 Load Resistance (lbs): 4409  
 Installation Requirement: Installation in sleeve set in concrete with a 20 - 30cm / 8 - 12" gravel drain bed  
 Screws: No visible screws  
 Diffuser: Clear tempered glass  
 Fixture Finish: SST  
 Fixture Material: Stainless Steel AISI 316L  
 Cable Details: Supplied with 1 power cable 5m in length

#### ELECTRICAL

Lamp Type: LED  
 Input Wattage (W): 5.9 / RGBW 6  
 Total Output Wattage (W): 5 / RGBW 6  
 Driver Included: No  
 Driver Location: Remote  
 Driver Type: White LED - Constant Voltage - 120 / 277Vac RGBW - Constant Current - Universal  
 Housing: (Not included - see components) L9A09600 allows for external driver (non-dimming - 120 / 277Vac [-30  
 Input Voltage (V): 120 - 277  
 Output Voltage (V): 24  
 Upon Request: (Not included - see components [IP65 or higher enclosure to be supplied by others]) 0-10Vdc dimming / Phase dimming / Non-dimming 120/277Vac / DMX

#### LED

Number of LEDs: 3 / RGBW 4  
 Color Temperature (°K): 3000 / 4000 / RGBW  
 Max. Delivered Lumen (lm): 435 - 465 / 450 - 485  
 Nominal Lumen (lm): 570 / 600  
 CRI: >80 CRI  
 Lamp Life (hrs): 60000

#### OPTICAL

Optic°: 12 / 33 / 44

#### RATINGS AND CERTIFICATIONS

Certified By: Certified for North American Standards  
 IP rating: IP68  
 IK Rating: IK10  
 Bug Rating: B0 U3 G0  
 Marine Grade: Stainless Steel AISI 316L  
 Upon Request: Higher Maximum Ambient Temperature

Copyright © 2024, 1-800-288-2363, E-111-347-8310, www.zaneen.com

Available for International specifications by adding 'INT' at the end of the existing Model #. For assistance on 'custom' specifications, contact zteam@zaneen.com. In a constant effort to supply the best product, we reserve the right to change specifications or materials without notice. The most recent specification sheets are found at zaneen.com

PROJECT \_\_\_\_\_  
 TYPE \_\_\_\_\_  
 SPECIFIER \_\_\_\_\_  
 QUANTITY \_\_\_\_\_  
 DATE \_\_\_\_\_



49mm 1 15/16"

49mm 1 15/16"

95mm 3 3/4"

95mm 3 3/4"

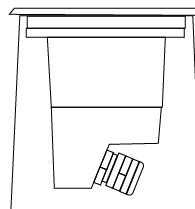
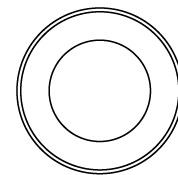
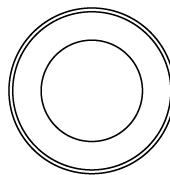

88mm 3 7/16"

97mm 3 13/16"

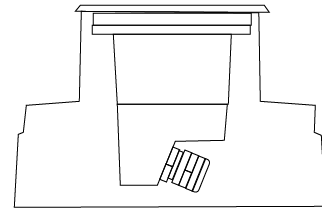

88mm 3 7/16"

97mm 3 13/16"

Slim Housing  
L9A09500

Wide Housing  
L9A09500



## MICRO RECESSED

E9I564-

PROJECT

TYPE

SPECIFIER

QUANTITY

DATE



## MICRO RECESSED

### E91570-

base number Color Lens  
Temperature Options

- To build a product code in our configurator select the specify button on the base model # product page
- To build a manual product code on this datasheet choose from the options listed below in blue font and add the suffix to the base model #

#### GENERAL

Series: Micro  
Brand: Platek  
Division: Exterior  
Mounting Type: Recessed  
Mounting Location: In-Ground  
Subcategory: Drive Over

#### PHYSICAL

Shape: Round  
Diameter (mm): 95  
Diameter (in): 3 3/4  
Height (mm): 88  
Height (in): 3 1/2  
Light Distribution: Uplight  
Weight (kg): 0.5  
Weight (lbs): 1.1  
Load Resistance (kg): 2000  
Load Resistance (lbs): 4409  
Installation Requirement: Installation in sleeve set in concrete with a 20 - 30cm / 8 - 12" gravel drain bed  
Screws: No visible screws  
Diffuser: Clear tempered glass  
Fixture Finish: SST  
Fixture Material: Stainless Steel AISI 316L  
Cable Details: Supplied with 1 power cable 0.5m in length

#### ELECTRICAL

Lamp Type: LED  
Input Wattage (W): 5.9  
Total Output Wattage (W): 5  
Driver Included: No  
Driver Location: Remote  
Driver Type: Constant Voltage - Universal  
Driver Class: Class 2  
Housing: (Not included - see components) L9A09600 allows for external driver (non-dimming - 120 / 277Vac - [-  
Input Voltage (V): 120 - 277  
Constant Current (MA): 500  
Upon Request: (Included) Integral w/L9A09600 ONLY - Non-dimming 120 / 277Vac / (Not included - see components [IP65 or higher enclosure to be supplied by others]) Remote: 0-10Vdc dimming / Phase dimming @120Vac only

#### LED

Number of LEDs: 3  
Color Temperature (°K): 3000 / 4000  
Max. Delivered Lumen (lm): 440 - 465 / 450 - 485  
Nominal Lumen (lm): 570 / 600  
CRI: >80 CRI  
Lamp Life (hrs): 60000

#### OPTICAL

Optic°: 12 / 33 / 44

#### RATINGS AND CERTIFICATIONS

Certified By: Certified for North American Standards  
IP rating: IP68  
IK Rating: IK10  
Bug Rating: B0 U3 G0

316 Marine Grade Stainless Steel AISI 316L © 2024, T 1900 380 2883, F 416-247-9319, www.zaneen.com

Available for international specifications by adding "INT" at the end of the existing Model #. For assistance on 'custom' specifications, contact zteam@zaneen.com.  
Upon Request: Higher Maximum Ambient Temperature  
In a constant effort to supply the best product, we reserve the right to change specifications or materials without notice. The most recent specification sheets are found at zaneen.com

PROJECT
TYPE
SPECIFIER
QUANTITY
DATE



49mm 1 15/16"

95mm 3 3/4"

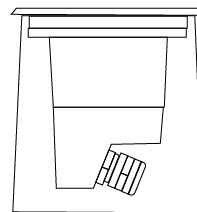
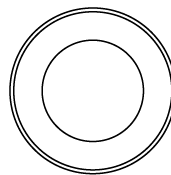

88mm 3 7/16"

97mm 3 13/16"

Slim Housing  
L9A09500



49mm 1 15/16"

95mm 3 3/4"

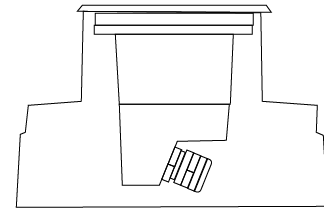
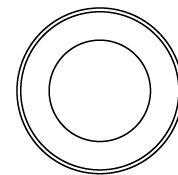

88mm 3 7/16"

97mm 3 13/16"

Wide Housing  
L9A09500

## MICRO RECESSED

E9I570-

PROJECT

TYPE

SPECIFIER

QUANTITY

DATE



## MICRO RECESSED

### E91630-

base number Lens Options

- To build a product code in our configurator select the specify button on the base model # product page
- To build a manual product code on this datasheet choose from the options listed below in blue font and add the suffix to the base model #

#### GENERAL

Series: Micro  
 Brand: Platek  
 Division: Exterior  
 Mounting Type: Recessed  
 Mounting Location: In-Ground  
 Subcategory: Drive Over

#### PHYSICAL

Shape: Round  
 Diameter (mm): 95  
 Diameter (in): 3 3/4  
 Height (mm): 97  
 Height (in): 3 13/16  
 Light Distribution: Direct  
 Weight (kg): 0.55  
 Weight (lbs): 1.2  
 Load Resistance (kg): 2000  
 Load Resistance (lbs): 4409  
 Installation Requirement: Installation in sleeve set in concrete with a 20 - 30cm / 8 - 12" gravel drain bed  
 Diffuser: Clear tempered glass  
 Fixture Finish: SST  
 Fixture Material: Aluminum Die Cast  
 Cable Details: Supplied with 1 power cable 1m in length

#### ELECTRICAL

Lamp Type: LED  
 Input Wattage (W): 6  
 Total Output Wattage (W): 6  
 Dimming: Bluetooth technology or DMX  
 Control Gear: DMX  
 Driver Included: No  
 Driver Location: Remote  
 Driver Type: Constant Current - Universal  
 Driver Class: Class 2  
 Input Voltage (V): 120 - 277  
 Constant Current (MA): 500

#### LED

Number of LEDs: 4  
 Color Temperature (°K): RGBW  
 CRI: >80 CRI  
 Lamp Life (hrs): 60000  
 Special LEDs offerings: RGBW

#### OPTICAL

Optic°: 12 / 33 / 44

#### RATINGS AND CERTIFICATIONS

Certified By: Certified for North American Standards  
 IP rating: IP68  
 IK Rating: IK10  
 Bug Rating: B0 U5 G0  
 Upon Request: Higher Maximum Ambient Temperature

PROJECT
TYPE
SPECIFIER
QUANTITY
DATE



49mm 1 15/16"

95mm 3 3/4"

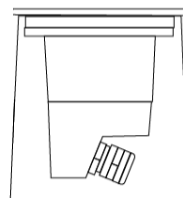
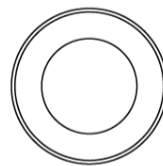

Slim Housing  
L9A09500

49mm 1 15/16"

95mm 3 3/4"

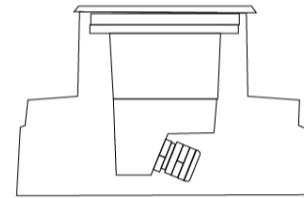
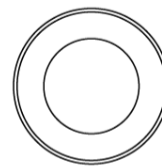

Wide Housing  
L9A09600



## MICRO RECESSED

E9I630-

PROJECT

TYPE

SPECIFIER

QUANTITY

DATE



PROJECT

TYPE

SPECIFIER

QUANTITY

DATE

### Fixture Finish

Stainless Steel Inox - SST



**Digital:** Not all screens are calibrated the same, and therefore, colors will appear differently between screens.

**Physical:** When texture is involved, there will be variations in color, character and tone within a product series and between product families.



PROJECT	
TYPE	
SPECIFIER	
QUANTITY	
DATE	

### LEGEND

floor-mounted	pivotal	special LED (upon request) RGB, RGBW, tunable, gold+, meat+, art+, fashion+
wall and ceiling: recessed and surface mounted	rotating	warm dim / natural dimming LED
ceiling-mounted and wall-mounted	illuminate tilted	rechargeable battery powered
wall-mounted	color of suspension cable	fixture with natural vivid LED (upon request)
omni-directional light distribution	length of suspension cable	color rendering index
direct light distribution	reflector degree selection	color temperature
direct/indirect light distribution	super spot	lumen (luminous flux)
indirect light distribution	lens	efficacy (lumens per watt)
asymmetric light distribution	lens pack	Unified Glare Rating (UGR) range from 5-40
aura light distribution	shine ring	marine grade (AISI 316 stainless steel)
round wall or ceiling cut-out	integrated shine ring with diffuser	walk on
square wall or ceiling cut-out	free individual colors 01-29	drive on
the supplied jig specifies the cutout dimensions	individual colors: 00 (free of charge), 01-25 (extra charge)	Dark Sky Compliance
minimum distance (meters) lamp - object	luminaire part to be colored (F1)	Americans with Disabilities Act (less than 4" off the wall located between 27"-84" from floor)
recessed depth	luminaire part to be colored (F2)	lamp protected against explosion
ceiling thickness in mm	luminaire part to be colored (F3)	blown glass using traditional methods by master glass blower
ceiling thickness selection	luminaire part to be colored (F4)	acoustic material
dimmable DP (phase), DV (0-10V), DD (dali), DS (step-dim)	luminaire part to be colored (F5)	protection class I, protection insulation
included or excluded LED driver/transformer/control gear	color of 3-circuit adaptor	protection class II, protection insulation
separately switchable	indirect diffuser	ETL Certified to UL and CSA Standards
sensor	direct diffuser	UL Certified to UL and CSA Standards
remote control	ball-proof (upon request)	CSA Certified to UL and CSA Standards
available upon request	accessory	Certified for North American Standards

### IP RATING

IP20	protected against ingress of solid bodies greater than 12.5mm (finger)
IP33	protected against ingress of solid bodies greater than 2.5mm protected against sprays of water up to 60 degrees from the vertical (rain)
IP40	protected against ingress of solid bodies greater than 1mm (wire) no protection against the ingress of moisture
IP43	protected against ingress of solid bodies greater than 1mm (wire) protected against sprays of water up to 60 degrees from the vertical (rain)
IP44	protected against ingress of solid bodies greater than 1mm (wire) protected against water splashed from all directions
IP54	protected against limited ingress of dust (wet rooms/covered outdoor areas) protected against water splashed from all directions
IP65	protected against ingress of dust protected against jets of water
IP66	protected against ingress of dust protected against powerful jets of water or heavy seas
IP67	protected against ingress of dust protected against immersion of water between 15cm - 1m for 30 minutes
IP68	protected against ingress of dust protected against immersion of water under pressure for long periods

### IK RATING

IK01	protected against 0.14 joules impact (equivalent to 0.25kg mass dropped from 56mm above the surface)
IK02	protected against 0.2 joules impact (equivalent to 0.25kg mass dropped from 80mm above the surface)
IK03	protected against 0.35 joules impact (equivalent to 0.25kg mass dropped from 140mm above the surface)
IK04	protected against 0.5 joules impact (equivalent to 0.25kg mass dropped from 200mm above the surface)
IK05	protected against 0.7 joules impact (equivalent to 0.25kg mass dropped from 280mm above the surface)
IK06	protected against 1 joules impact (equivalent to 0.25kg mass dropped from 400mm above the surface)
IK07	protected against 2 joules impact (equivalent to 0.5kg mass dropped from 400mm above the surface)
IK08	protected against 5 joules impact (equivalent to 1.7kg mass dropped from 300mm above the surface)
IK09	protected against 10 joules impact (equivalent to 5.0kg mass dropped from 200mm above the surface)
IK10	protected against 20 joules impact (equivalent to 5.0kg mass dropped from 400mm above the surface)