

## MINI 1200 RECESSED

### E91199- \_\_\_\_\_ - \_\_\_\_\_

base number    Color    Lens  
 Temperature    Options

- To build a product code in our configurator select the specify button on the base model # product page
- To build a manual product code on this datasheet choose from the options listed below in blue font and add the suffix to the base model #

#### GENERAL

Series: Mini  
 Subseries: Mini 1200  
 Brand: Platek  
 Division: Exterior  
 Mounting Type: Recessed  
 Mounting Location: In-Ground  
 Subcategory: Drive Over

#### PHYSICAL

Shape: Round  
 Diameter (mm): 140  
 Diameter (in): 5 1/2  
 Depth (mm): 80  
 Depth (in): 3 1/8  
 Light Distribution: Direct  
 Weight (kg): 1.1  
 Weight (lbs): 2.43  
 Load Resistance (kg): 2500  
 Load Resistance (lbs): 5511  
 Installation Requirement: Installation with L9A08800 sleeve set in concrete requires a 20-30cm / 8-12" gravel drain bed  
 Diffuser: Clear tempered glass  
 Fixture Finish: BLK  
 Fixture Material: Aluminum Die Cast  
 Cable Details: Supplied with 1 power cable 1m in length

#### ELECTRICAL

Lamp Type: LED  
 Input Wattage (W): 10.5  
 Total Output Wattage (W): 9  
 Dimming: Non-Dimming / Phase Dimming (120Vac only) / 0-10V Dimming  
 Driver Included: No  
 Driver Location: Remote  
 Driver Type: Constant Current - 120 / 277Vac  
 Driver Class: Class 2  
 Input Voltage (V): 120 - 277  
 Constant Current (MA): 500

#### LED

Number of LEDs: 6  
 Color Temperature (°K): 3000 / 4000  
 Max. Delivered Lumen (lm): 775 - 955 / 805 - 995  
 Nominal Lumen (lm): 1140 / 1200  
 CRI: >80 CRI  
 Lamp Life (hrs): 60000

#### OPTICAL

Optic°: 9 / 28 / 44  
 Adjustability: Tilt ±5°

#### RATINGS AND CERTIFICATIONS

Certified By: Certified for North American Standards  
 IP rating: IP68  
 IK Rating: IK10  
 Bug Rating: B0 U4 G0  
 Upon Request: Higher Maximum Ambient Temperature

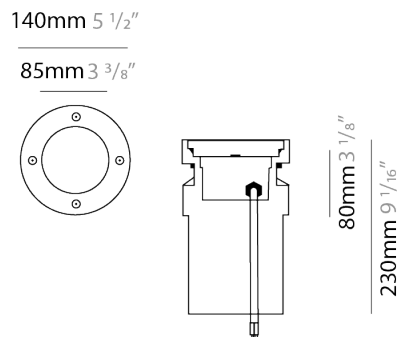
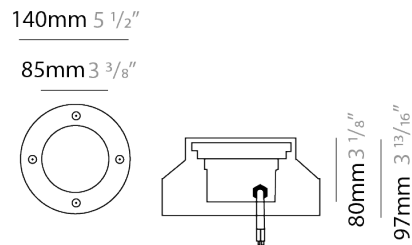

## MINI 1200 RECESSED

E9I199-

PROJECT

TYPE

SPECIFIER

QUANTITY

DATE



PROJECT	_____
TYPE	_____
SPECIFIER	_____
QUANTITY	_____
DATE	_____

## MINI SS - DRIVE OVER RECESSED

### E91254-

base number Color Lens  
Temperature Options

- To build a product code in our configurator select the specify button on the base model # product page
- To build a manual product code on this datasheet choose from the options listed below in blue font and add the suffix to the base model #

#### GENERAL

Series: Mini  
Subseries: Mini SS - Drive Over  
Brand: Platek  
Division: Exterior  
Mounting Type: Recessed  
Mounting Location: In-Ground  
Subcategory: Drive Over

#### PHYSICAL

Shape: Round  
Diameter (mm): 152  
Diameter (in): 6  
Depth (mm): 80  
Depth (in): 3 1/8  
Light Distribution: Uplight  
Weight (kg): 1.5  
Weight (lbs): 3.3  
Load Resistance (kg): 2500  
Load Resistance (lbs): 5511  
Installation Requirement: Installation with L9A08800 sleeve set in concrete requires a 20-30 cm gravel drain bed  
Screws: A4 stainless steel  
Diffuser: Clear tempered glass  
Fixture Finish: SST  
Fixture Material: Aluminum Die Cast  
Cable Details: Supplied with 1 power cable 1m in length

#### ELECTRICAL

Lamp Type: LED  
Input Wattage (W): 10.5  
Total Output Wattage (W): 9  
Dimming: Tri-Mode (Non-Dimming and Phase Dimming (120Vac only) and 0-10V Dimming)  
Driver Included: No  
Driver Location: Remote  
Driver Type: Constant Voltage - 120 / 277Vac  
Driver Class: Class 2  
Input Voltage (V): 120 - 277  
Constant Current (MA): 500

#### LED

Number of LEDs: 6  
Color Temperature (°K): 3000 / 4000  
Max. Delivered Lumen (lm): 775 - 955 / 805 - 995  
Nominal Lumen (lm): 1140 / 1200  
CRI: >80 CRI  
Lamp Life (hrs): 60000

#### OPTICAL

Optic°: 9 / 28 / 44  
Adjustability: Tilt ±5°

#### RATINGS AND CERTIFICATIONS

Certified By: Certified for North American Standards  
IP rating: IP68  
IK Rating: IK10  
Bug Rating: B0 U4 G0  
Upon Request: Higher Maximum Ambient Temperature



140mm 5 1/2"

85mm 3 3/8"

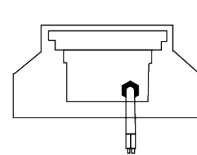
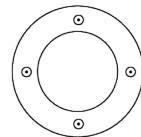

80mm 3 1/8"  
97mm 3 13/16"

140mm 5 1/2"

85mm 3 3/8"

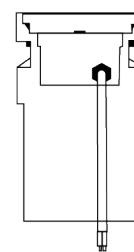
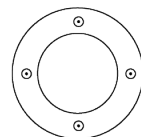

80mm 3 1/8"  
230mm 9 1/16"



## MINI SS - DRIVE OVER RECESSED

E9I254-

PROJECT	_____
TYPE	_____
SPECIFIER	_____
QUANTITY	_____
DATE	_____

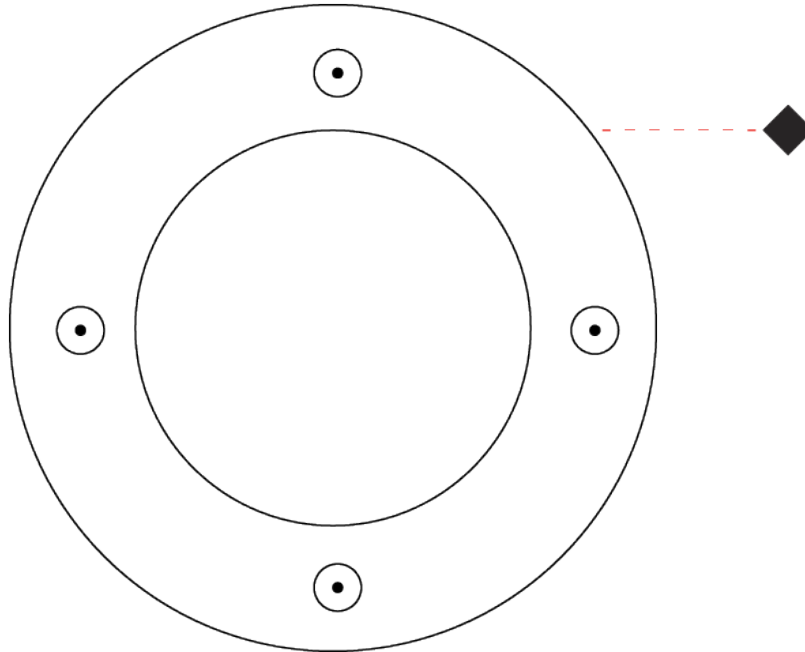

## MINI ROLL OVER 1 OPENING RECESSED

### E9I330-

base number \_\_\_\_\_ Color \_\_\_\_\_ Finish \_\_\_\_\_  
 Temperature \_\_\_\_\_ Options \_\_\_\_\_

- To build a product code in our configurator select the specify button on the base model # product page
- To build a manual product code on this datasheet choose from the options listed below in blue font and add the suffix to the base model #

#### GENERAL

Series: Mini  
 Subseries: Mini Roll Over 1 Opening  
 Brand: Platak  
 Division: Exterior  
 Mounting Type: Recessed  
 Mounting Location: In-Ground  
 Subcategory: Marker

#### PHYSICAL

Shape: Round  
 Diameter (mm): 145  
 Diameter (in): 5 <sup>11</sup>/<sub>16</sub>  
 Height (mm): 118  
 Height (in): 4 <sup>5</sup>/<sub>8</sub>  
 Light Distribution: Direct  
 Weight (kg): 1.6  
 Weight (lbs): 3.53  
 Load Resistance (kg): 2000  
 Load Resistance (lbs): 4400  
 Diffuser: Clear tempered glass  
 Fixture Finish: [BLK](#) / [WHI](#) / [GRY](#) / [COR](#) / [ANT](#) / [BRZ](#)  
 Fixture Material: Aluminum Die Cast

#### ELECTRICAL

Lamp Type: LED  
 Input Wattage (W): 2.5  
 Total Output Wattage (W): 1.5  
 Dimming: Non-Dimmable  
 Driver Included: Yes  
 Driver Location: Integrated  
 Driver Type: Constant Current - 120Vac  
 Driver Class: Class 2  
 Input Voltage (V): 120 - 277  
 Constant Current (MA): 500

Upon Request: Dimming requires a minimum of 4 fixtures per power supply (See components [IP65 or higher enclosure to be supplied by others]) Remote: 0-10Vdc dimming / Phase dimming @120Vac / Non-dimming 120/277Vac

#### LED

Color Temperature (°K): [2700](#) / [3000](#) / [4000](#)  
 Max. Delivered Lumen (lm): 55 / 60  
 Nominal Lumen (lm): 190 / 200  
 CRI: >80 CRI  
 Lamp Life (hrs): 60000

#### OPTICAL

Optic°: 1 Opening  
 Beam Angle: 90

#### RATINGS AND CERTIFICATIONS

Certified By: Certified for North American Standards  
 IP rating: IP68  
 IK Rating: IK10  
 Bug Rating: B0 U2 G1  
 Upon Request: Higher Maximum Ambient Temperature

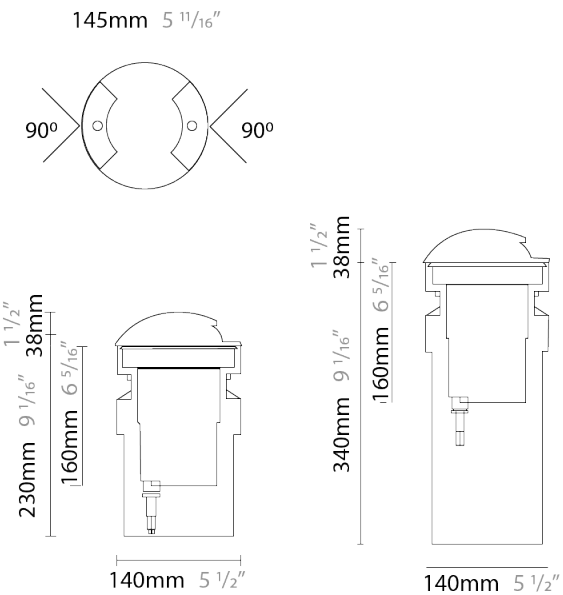

## MINI ROLL OVER 1 OPENING RECESSED

E9I330-

PROJECT

TYPE

SPECIFIER

QUANTITY

DATE

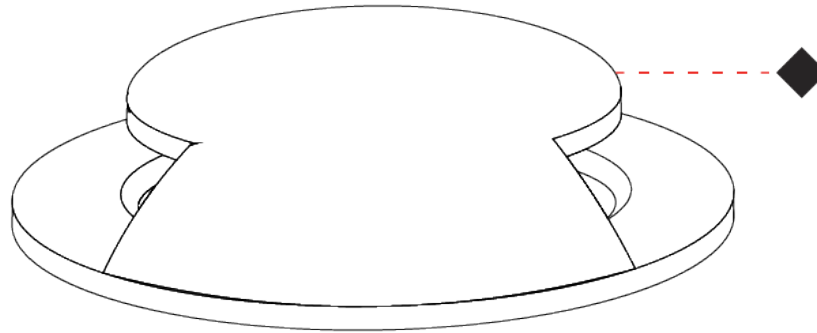

PROJECT	_____
TYPE	_____
SPECIFIER	_____
QUANTITY	_____
DATE	_____

## MINI ROLL OVER 2 OPENING RECESSED

### E9I333-

base number          Color          Finish           
 Temperature          Options         

- To build a product code in our configurator select the specify button on the base model # product page
- To build a manual product code on this datasheet choose from the options listed below in blue font and add the suffix to the base model #

#### GENERAL

Series: Mini  
 Subseries: Mini Roll Over 2 Opening  
 Brand: Platak  
 Division: Exterior  
 Mounting Type: Recessed  
 Mounting Location: In-Ground  
 Subcategory: Marker

#### PHYSICAL

Shape: Round  
 Diameter (mm): 145  
 Diameter (in): 5 <sup>11</sup>/<sub>16</sub>  
 Height (mm): 118  
 Height (in): 4 <sup>5</sup>/<sub>8</sub>  
 Light Distribution: Direct  
 Weight (kg): 1.8  
 Weight (lbs): 4  
 Load Resistance (kg): 2000  
 Load Resistance (lbs): 4400  
 Diffuser: Clear tempered glass  
 Fixture Finish: [BLK](#) / [WHI](#) / [GRY](#) / [COR](#) / [ANT](#) / [BRZ](#)  
 Fixture Material: Aluminum Die Cast

#### ELECTRICAL

Lamp Type: LED  
 Input Wattage (W): 4.2  
 Total Output Wattage (W): 3  
 Dimming: Non-Dimmable  
 Driver Included: Yes  
 Driver Location: Integrated  
 Driver Type: Constant Current - 120Vac  
 Driver Class: Class 2  
 Input Voltage (V): 120 - 277  
 Constant Current (MA): 350  
 Upon Request: (Not included - see components [IP65 or higher enclosure to be supplied by others]) Remote: 0-10Vdc dimming / Phase dimming @120Vac / Non-dimming 120/277Vac

#### LED

Color Temperature (°K): [3000](#) / [4000](#)  
 Max. Delivered Lumen (lm): 110 / 115  
 Nominal Lumen (lm): 380 / 400  
 CRI: >80 CRI  
 Lamp Life (hrs): 60000

#### OPTICAL

Optic°: 2 Openings  
 Beam Angle: 2 x 90

#### RATINGS AND CERTIFICATIONS

Certified By: Certified for North American Standards  
 IP rating: IP68  
 IK Rating: IK10  
 Bug Rating: B0 U2 G1  
 Upon Request: Higher Maximum Ambient Temperature

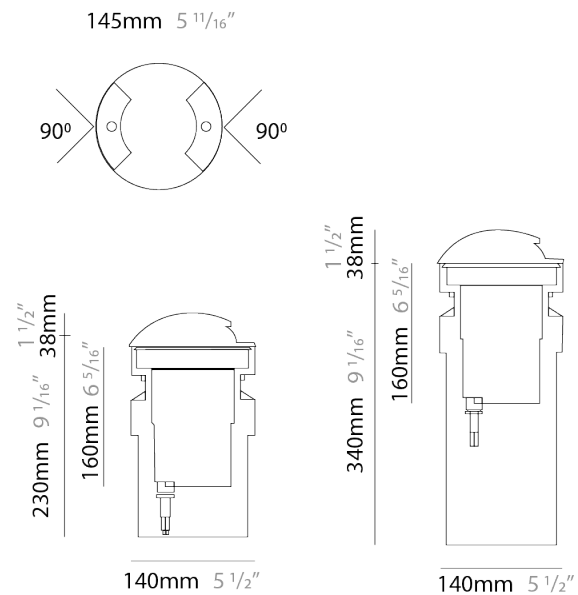

## MINI ROLL OVER 2 OPENING RECESSED

E9I333-

PROJECT	_____
TYPE	_____
SPECIFIER	_____
QUANTITY	_____
DATE	_____

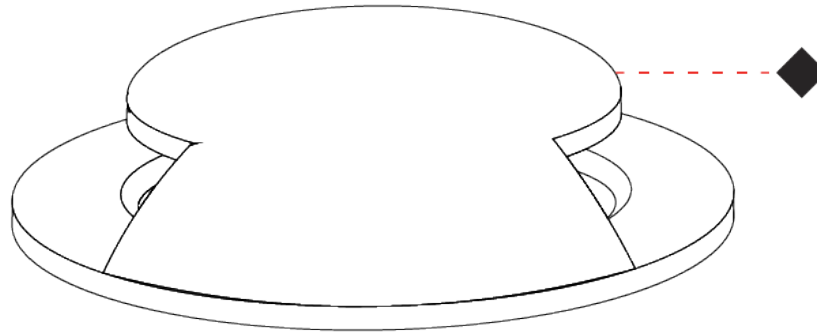



## MINI ROLL OVER 4 OPENING RECESSED

### E91336-

base number Color Finish  
 Temperature Options

- To build a product code in our configurator select the specify button on the base model # product page
- To build a manual product code on this datasheet choose from the options listed below in blue font and add the suffix to the base model #

#### GENERAL

Series: Mini  
 Subseries: Mini Roll Over 4 Opening  
 Brand: Platek  
 Division: Exterior  
 Mounting Type: Recessed  
 Mounting Location: In-Ground  
 Subcategory: Marker

#### PHYSICAL

Shape: Round  
 Diameter (mm): 145  
 Diameter (in): 5 11/16  
 Height (mm): 118  
 Height (in): 4 5/8  
 Light Distribution: Direct  
 Weight (kg): 1.8  
 Weight (lbs): 4  
 Load Resistance (kg): 2000  
 Load Resistance (lbs): 4400  
 Diffuser: Clear tempered glass  
 Fixture Finish: [BLK](#) / [WHI](#) / [GRY](#) / [COR](#) / [ANT](#) / [BRZ](#)  
 Fixture Material: Aluminum Die Cast

#### ELECTRICAL

Lamp Type: LED  
 Input Wattage (W): 7.4  
 Total Output Wattage (W): 6  
 Dimming: Non-Dimmable  
 Driver Included: Yes  
 Driver Location: Integrated  
 Driver Type: Constant Current - 120 / 277Vac  
 Driver Class: Class 2  
 Input Voltage (V): 120 - 277  
 Constant Current (MA): 500  
 Upon Request: Remote: 0-10Vdc dimming / Phase dimming (-30°C or -40°C) / Non-dimming 120/277Vac (-30°C)

#### LED

Color Temperature (°K): [3000](#) / [4000](#)  
 Max. Delivered Lumen (lm): 215 / 225  
 Nominal Lumen (lm): 760 / 800  
 CRI: >80 CRI  
 Lamp Life (hrs): 60000

#### OPTICAL

Optic: 4 Openings  
 Beam Angle: 60

#### RATINGS AND CERTIFICATIONS

Certified By: Certified for North American Standards  
 IP rating: IP68  
 IK Rating: IK10  
 Bug Rating: B0 U3 G1  
 Upon Request: Higher Maximum Ambient Temperature



Ø145mm (5 11/16")

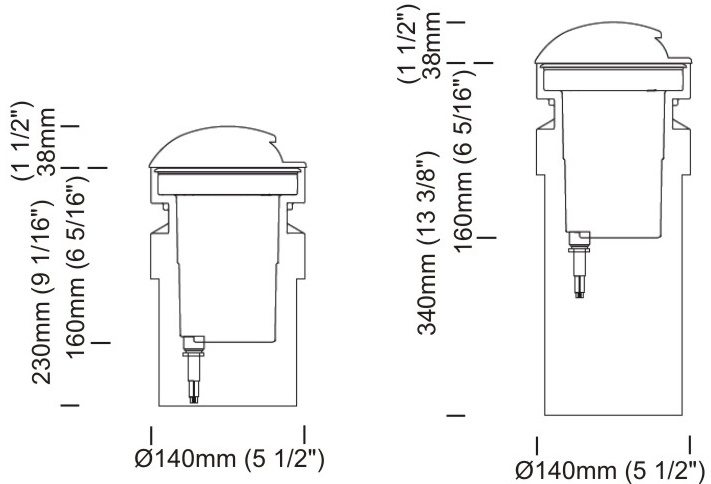
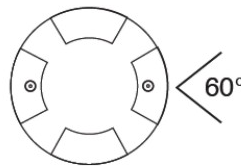

## MINI ROLL OVER 4 OPENING RECESSED

E9I336-

### Finish chart

■ 01 - Black

Available upon request

□ 02 - White

■ 06 - Gray

■ 07 - Corten

■ 08 - Anthracite

■ 09 - Bronze

### Order Example

L9XXXX- 06

Gray

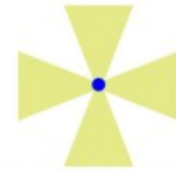

4 OPENINGS

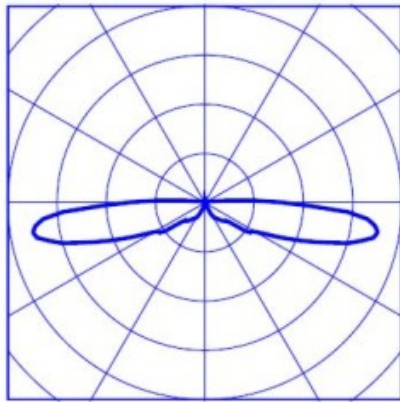

5613  
cd/klm

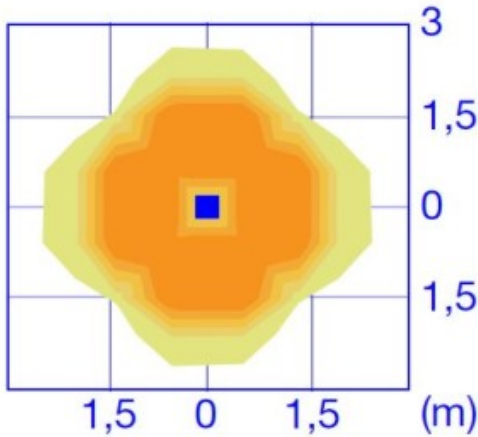

3000K

■ 5 lux  
 ■ 4 lux  
 ■ 3 lux  
 ■ 2 lux  
 ■ 1 lux



## MINI FULL INOX RECESSED

### E9I576-

base number            Color            Lens             
 Temperature            Options           

- To build a product code in our configurator select the specify button on the base model # product page
- To build a manual product code on this datasheet choose from the options listed below in blue font and add the suffix to the base model #

#### GENERAL

Series: Mini  
 Subseries: Mini Full Inox  
 Brand: Platek  
 Division: Exterior  
 Mounting Type: Recessed  
 Mounting Location: In-Ground  
 Subcategory: Drive Over

#### PHYSICAL

Shape: Round  
 Diameter (mm): 152  
 Diameter (in): 6  
 Height (mm): 80  
 Height (in): 3 1/8  
 Light Distribution: Uplight  
 Load Resistance (kg): 2000  
 Load Resistance (lbs): 4409  
 Installation Requirement: Installation in sleeve set in concrete with a 20-30 cm gravel drain bed  
 Screws: A4 stainless steel  
 Diffuser: Clear tempered glass  
 Fixture Finish: SST  
 Fixture Material: Stainless Steel  
 Cable Details: Supplied with 1 power cable 0.5m in length

#### ELECTRICAL

Lamp Type: LED  
 Input Wattage (W): 11  
 Total Output Wattage (W): 10  
 Driver Included: No  
 Driver Location: Remote  
 Driver Type: Constant Voltage - Universal  
 Housing: (Not included - see components) L9A08800 allows for external driver (non-dimming - 120 / 277Vac) / L  
 Input Voltage (V): 120 - 277  
 Output Voltage (V): 24  
 Upon Request: (Not included - see components [IP65 or higher enclosure to be supplied by others]) 0-10Vdc dimming / Phase dimming / Non-dimming 120/277Vac

#### LED

Number of LEDs: 6  
 Color Temperature (°K): 3000 / 4000  
 Max. Delivered Lumen (lm): 960 / 995  
 Nominal Lumen (lm): 1140 / 1200  
 CRI: >80 CRI  
 Lamp Life (hrs): 60000

#### OPTICAL

Optic: 9 / 28 / 44 / ASY; RGBW - 9 / 28 / 44

#### RATINGS AND CERTIFICATIONS

Certified By: Certified for North American Standards  
 IP rating: IP68  
 IK Rating: IK10  
 Bug Rating: B0 U4 G0  
 Marine Grade: Stainless Steel AISI 316L  
 Upon Request: Higher Maximum Ambient Temperature

PROJECT	_____
TYPE	_____
SPECIFIER	_____
QUANTITY	_____
DATE	_____

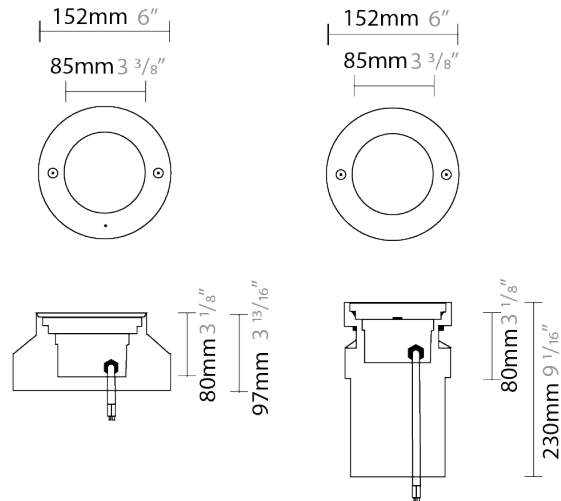
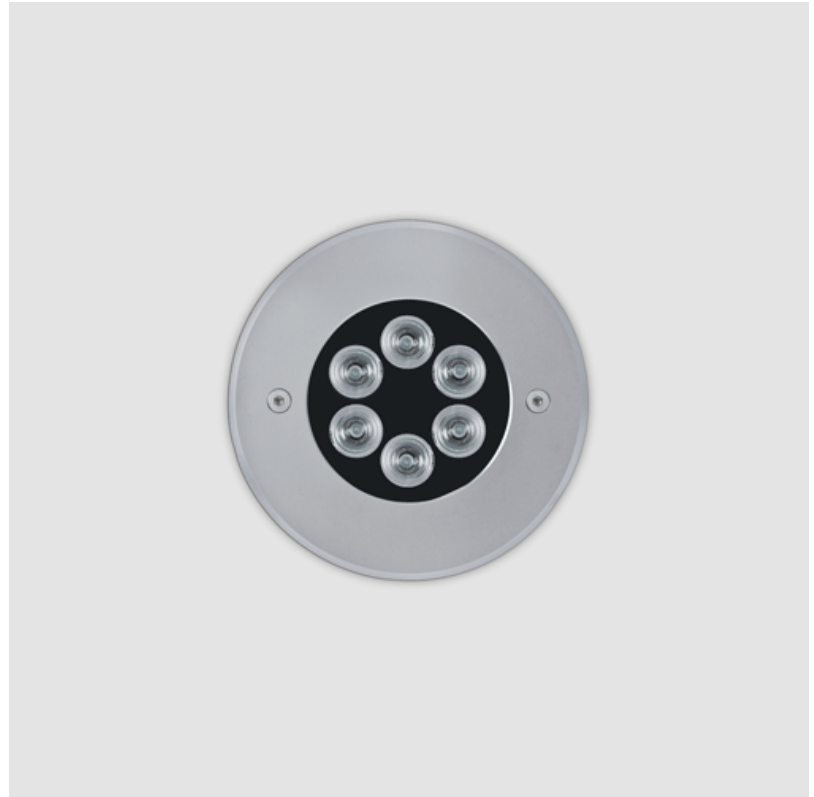

Housing  
L9A08800

Housing  
L9A08800



## MINI FULL INOX RECESSED

E9I576-

PROJECT	_____
TYPE	_____
SPECIFIER	_____
QUANTITY	_____
DATE	_____



## MINI FULL INOX RECESSED

**E91582-** \_\_\_\_\_ - \_\_\_\_\_  
 base number Color Lens  
 Temperature Options

- To build a product code in our configurator select the specify button on the base model # product page
- To build a manual product code on this datasheet choose from the options listed below in blue font and add the suffix to the base model #

### GENERAL

Series: Mini  
 Subseries: Mini Full Inox  
 Brand: Platek  
 Division: Exterior  
 Mounting Type: Recessed  
 Mounting Location: In-Ground  
 Subcategory: Drive Over

### PHYSICAL

Shape: Round  
 Diameter (mm): 152  
 Diameter (in): 6  
 Height (mm): 80  
 Height (in): 3 1/8  
 Light Distribution: Uplight  
 Load Resistance (kg): 2500  
 Load Resistance (lbs): 5511  
 Installation Requirement: Installation in sleeve set in concrete with a 20-30 cm gravel drain bed  
 Screws: A4 stainless steel  
 Diffuser: Extra Clear Flat Tempered Glass - 15mm / 15/32"  
 Fixture Finish: SST  
 Fixture Material: Stainless Steel  
 Cable Details: Supplied with 1 power cable 0.5m in length

### ELECTRICAL

Lamp Type: LED  
 Input Wattage (W): 10  
 Total Output Wattage (W): 8.4  
 Driver Included: No  
 Driver Location: Remote  
 Driver Type: Constant Current - 120 / 277Vac  
 Driver Class: Class 2  
 Input Voltage (V): 120 - 277  
 Constant Current (mA): 500  
 Upon Request: (Not included - see components [IP68 or higher enclosure to be supplied by others]) 0-10Vdc dimming / Phase dimming 120Vac only / Non-dimming

### LED

Number of LEDs: 6  
 Color Temperature (°K): 3000 / 4000  
 Max. Delivered Lumen (lm): 775 - 906 / 805 - 995  
 CRI: >80 CRI  
 Lamp Life (hrs): 60000

### OPTICAL

Optic°: 9 / 28 / 44  
 Beam Angle: Asymmetrical

### RATINGS AND CERTIFICATIONS

Certified By: Certified for North American Standards  
 IP rating: IP68  
 IK Rating: IK10  
 Bug Rating: B0 U4 G0  
 Upon Request: Higher Maximum Ambient Temperature

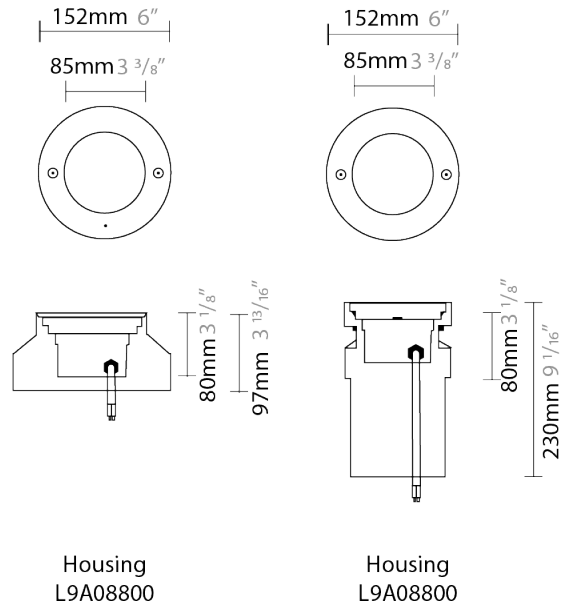

## MINI FULL INOX RECESSED

E9I582-

PROJECT

TYPE

SPECIFIER

QUANTITY

DATE

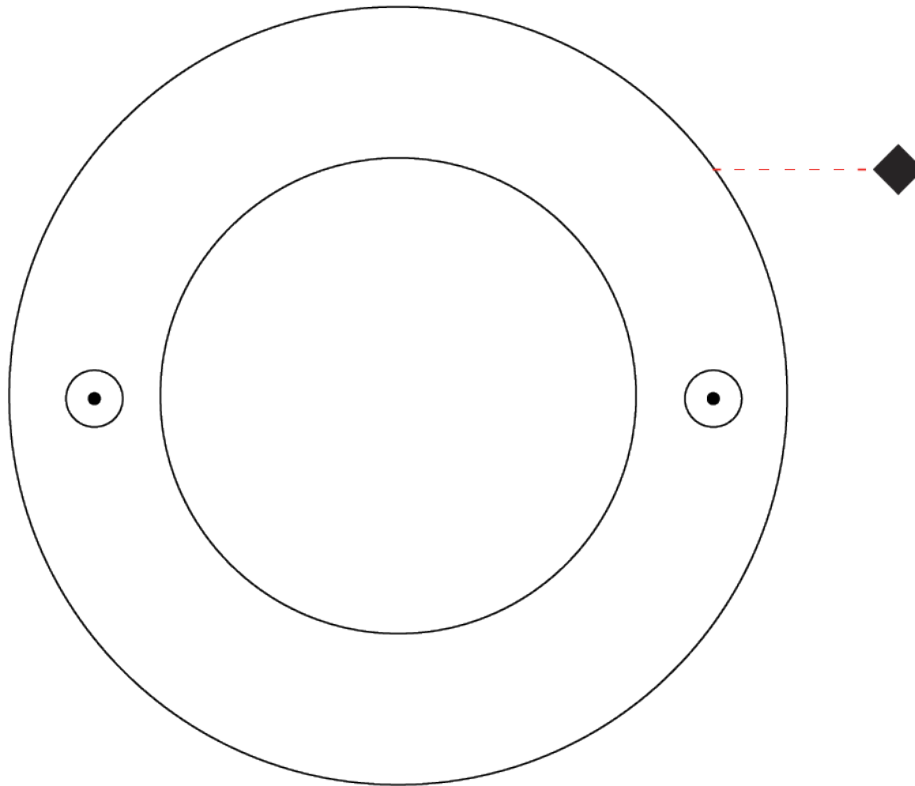

## MINI FULL INOX RECESSED

### E91633-

base number Lens  
 Options

- To build a product code in our configurator select the specify button on the base model # product page
- To build a manual product code on this datasheet choose from the options listed below in blue font and add the suffix to the base model #

#### GENERAL

Series: Mini  
 Subseries: Mini Full Inox  
 Brand: Platek  
 Division: Exterior  
 Mounting Type: Recessed  
 Mounting Location: In-Ground  
 Subcategory: Drive Over

#### PHYSICAL

Shape: Round  
 Diameter (mm): 152  
 Diameter (in): 6  
 Height (mm): 80  
 Height (in): 3 1/8  
 Light Distribution: Uplight  
 Load Resistance (kg): 2500  
 Load Resistance (lbs): 5511  
 Installation Requirement: Installation in sleeve set in concrete with a 20-30 cm gravel drain bed  
 Screws: A4 stainless steel  
 Diffuser: Extra Clear Flat Tempered Glass - 15mm / 15/32"  
 Fixture Finish: SST  
 Fixture Material: Stainless Steel  
 Cable Details: Supplied with 1 power cable 0.5m in length

#### ELECTRICAL

Lamp Type: LED  
 Total Output Wattage (W): 11.5  
 Dimming: Bluetooth technology or DMX  
 Control Gear: DMX  
 Driver Included: No  
 Driver Location: Remote  
 Driver Type: Constant Current - Universal  
 Input Voltage (V): 120 - 277  
 Constant Current (MA): 500

#### LED

Number of LEDs: 8  
 Color Temperature (°K): RGBW  
 CRI: >80 CRI  
 Lamp Life (hrs): 60000  
 Special LEDs offerings: RGBW

#### OPTICAL

Optic: 9 / 28 / 44

#### RATINGS AND CERTIFICATIONS

Certified By: Certified for North American Standards  
 IP rating: IP68  
 IK Rating: IK10  
 Upon Request: Higher Maximum Ambient Temperature

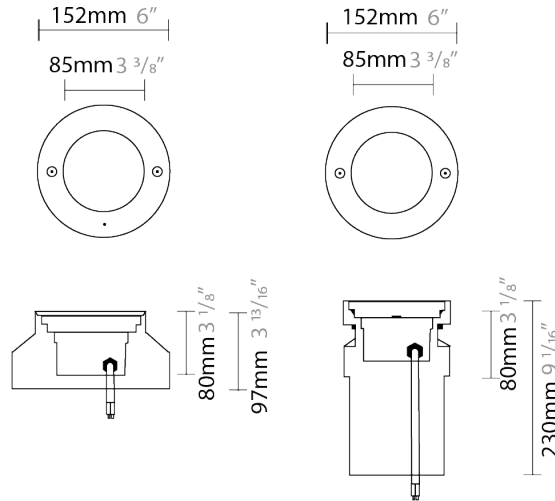
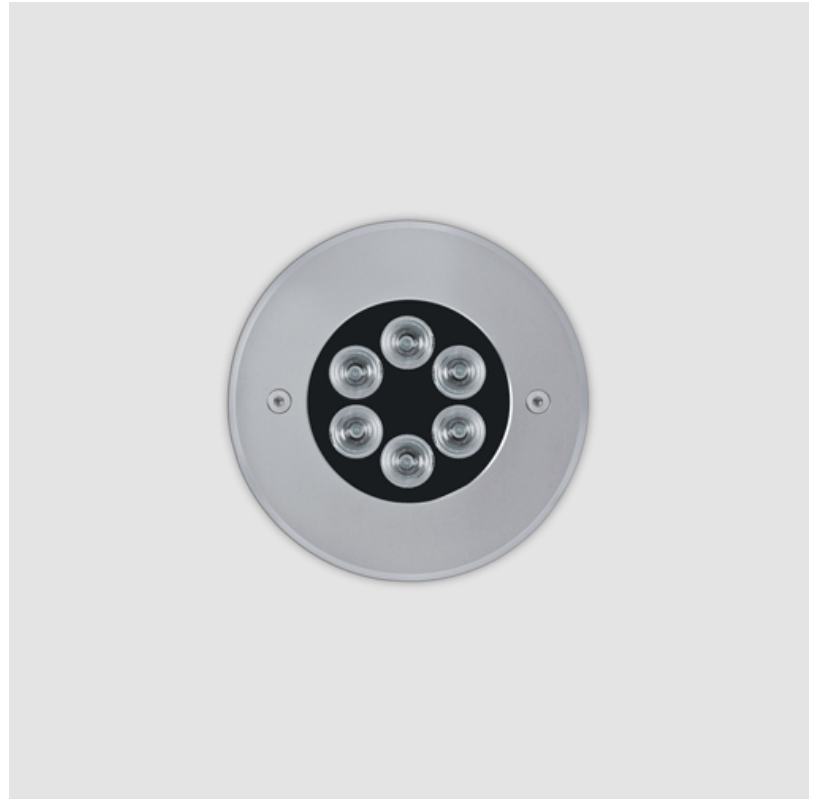

Housing  
L9A08800

Housing  
L9A08800



## MINI FULL INOX RECESSED

E9I633-

PROJECT	_____
TYPE	_____
SPECIFIER	_____
QUANTITY	_____
DATE	_____





## MINI COLOR FINISH CHART

PROJECT	_____
TYPE	_____
SPECIFIER	_____
QUANTITY	_____
DATE	_____

### Fixture Finish

Black - BLK



Stainless Steel Inox - SST

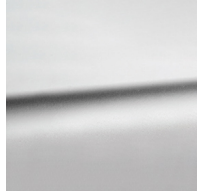

White - WHI

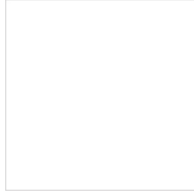

Gray - GRY

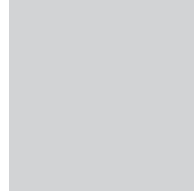

Corten - COR



Anthracite - ANT

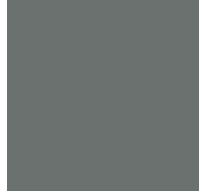

Bronze - BRZ







































































**Digital:** Not all screens are calibrated the same, and therefore, colors will appear differently between screens.

**Physical:** When texture is involved, there will be variations in color, character and tone within a product series and between product families.



### LEGEND

	floor-mounted		pivotal		special LED (upon request) RGB, RGBW, tunable, gold+, meat+, art+, fashion+
	wall and ceiling: recessed and surface mounted		rotating		warm dim / natural dimming LED
	ceiling-mounted and wall-mounted		illuminate tilted		rechargeable battery powered
	wall-mounted		color of suspension cable		fixture with natural vivid LED (upon request)
	omni-directional light distribution		length of suspension cable		color rendering index
	direct light distribution		reflector degree selection		color temperature
	direct/indirect light distribution		super spot		lumen (luminous flux)
	indirect light distribution		lens		efficacy (lumens per watt)
	asymmetric light distribution		lens pack		Unified Glare Rating (UGR) range from 5-40
	aura light distribution		shine ring		marine grade (AISI 316 stainless steel)
	round wall or ceiling cut-out		integrated shine ring with diffuser		walk on
	square wall or ceiling cut-out		free individual colors 01-29		drive on
	the supplied jig specifies the cutout dimensions		individual colors: 00 (free of charge), 01-25 (extra charge)		Dark Sky Compliance
	minimum distance (meters) lamp - object		luminaire part to be colored (F1)		Americans with Disabilities Act (less than 4" off the wall located between 27"-84" from floor)
	recessed depth		luminaire part to be colored (F2)		lamp protected against explosion
	ceiling thickness in mm		luminaire part to be colored (F3)		blown glass using traditional methods by master glass blower
	ceiling thickness selection		luminaire part to be colored (F4)		acoustic material
	dimmable DP (phase), DV (0-10V), DD (dali), DS (step-dim)		luminaire part to be colored (F5)		protection class I, protection insulation
	included or excluded LED driver/transformer/control gear		color of 3-circuit adaptor		protection class II, protection insulation
	separately switchable		indirect diffuser		ETL Certified to UL and CSA Standards
	sensor		direct diffuser		UL Certified to UL and CSA Standards
	remote control		ball-proof (upon request)		CSA Certified to UL and CSA Standards
	available upon request		accessory		Certified for North American Standards

### IP RATING

	protected against ingress of solid bodies greater than 12.5mm (finger)
	protected against ingress of solid bodies greater than 2.5mm protected against sprays of water up to 60 degrees from the vertical (rain)
	protected against ingress of solid bodies greater than 1mm (wire) no protection against the ingress of moisture
	protected against ingress of solid bodies greater than 1mm (wire) protected against sprays of water up to 60 degrees from the vertical (rain)
	protected against ingress of solid bodies greater than 1mm (wire) protected against water splashed from all directions
	protected against limited ingress of dust (wet rooms/covered outdoor areas) protected against water splashed from all directions
	protected against ingress of dust protected against jets of water
	protected against ingress of dust protected against powerful jets of water or heavy seas
	protected against ingress of dust protected against immersion of water between 15cm - 1m for 30 minutes
	protected against ingress of dust protected against immersion of water under pressure for long periods

### IK RATING

	protected against 0.14 joules impact (equivalent to 0.25kg mass dropped from 56mm above the surface)
	protected against 0.2 joules impact (equivalent to 0.25kg mass dropped from 80mm above the surface)
	protected against 0.35 joules impact (equivalent to 0.25kg mass dropped from 140mm above the surface)
	protected against 0.5 joules impact (equivalent to 0.25kg mass dropped from 200mm above the surface)
	protected against 0.7 joules impact (equivalent to 0.25kg mass dropped from 280mm above the surface)
	protected against 1 joules impact (equivalent to 0.25kg mass dropped from 400mm above the surface)
	protected against 2 joules impact (equivalent to 0.5kg mass dropped from 400mm above the surface)
	protected against 5 joules impact (equivalent to 1.7kg mass dropped from 300mm above the surface)
	protected against 10 joules impact (equivalent to 5.0kg mass dropped from 200mm above the surface)
	protected against 20 joules impact (equivalent to 5.0kg mass dropped from 400mm above the surface)