

PROJECT	
TYPE	
SPECIFIER	
QUANTITY	
DATE	

MIRA SUSPENSION

D101515-

base number	LED Dimming	Color Temperature	Finish Options
-------------	-------------	-------------------	----------------

- To build a product code in our configurator select the specify button on the base model # product page
- To build a manual product code on this datasheet choose from the options listed below in blue font and add the suffix to the base model #

GENERAL

Series: Mira
Brand: Quasar
Division: Design
Mounting Type: Suspension
Mounting Location: Ceiling
Subcategory: Ambient

PHYSICAL

Shape: Abstract
Diameter (mm): 1000
Diameter (in): 39 ³ / ₈
Height (mm): 1000
Height (in): 39 ³ / ₈
Max. Overall Height (mm): 3000
Max. Overall Height (in): 118 ¹ / ₈
Light Distribution: Omnidirectional
Weight (kg): 3
Weight (lbs): 6.61
Fixture Finish: NIC / BRA / BBR
Fixture Material: Metal
Cable Details: 2000mm Cable
Upon Request: Custom Sizes

ELECTRICAL

Lamp Type: LED
Input Wattage (W): 28.8
Dimming: Non-Dimming / Phase Dimming (120vac Only)
Driver Included: Yes
Driver Location: Integrated
Driver Type: Constant Voltage - Universal
Driver Class: Class 2
Input Voltage (V): 120 - 277
Output Voltage (V): 12
Upon Request: (Not included - see components) Integral: 0-10Vdc dimming

LED

Number of LEDs: 48
Color Temperature (°K): 2400 / 2800
Max. Delivered Lumen (lm): 1440 (2800K)
CRI: >97 CRI
Lamp Life (hrs): 50000

OPTICAL

RATINGS AND CERTIFICATIONS

Certified By: Certified for North American Standards
IP rating: IP20

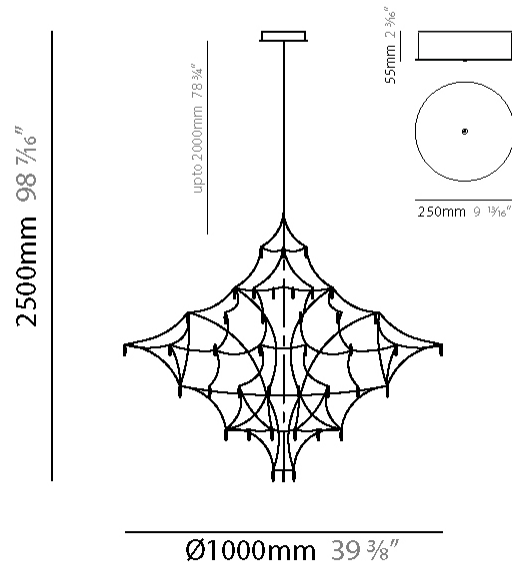

MIRA SUSPENSION

D101515-

PROJECT

TYPE

SPECIFIER

QUANTITY

DATE

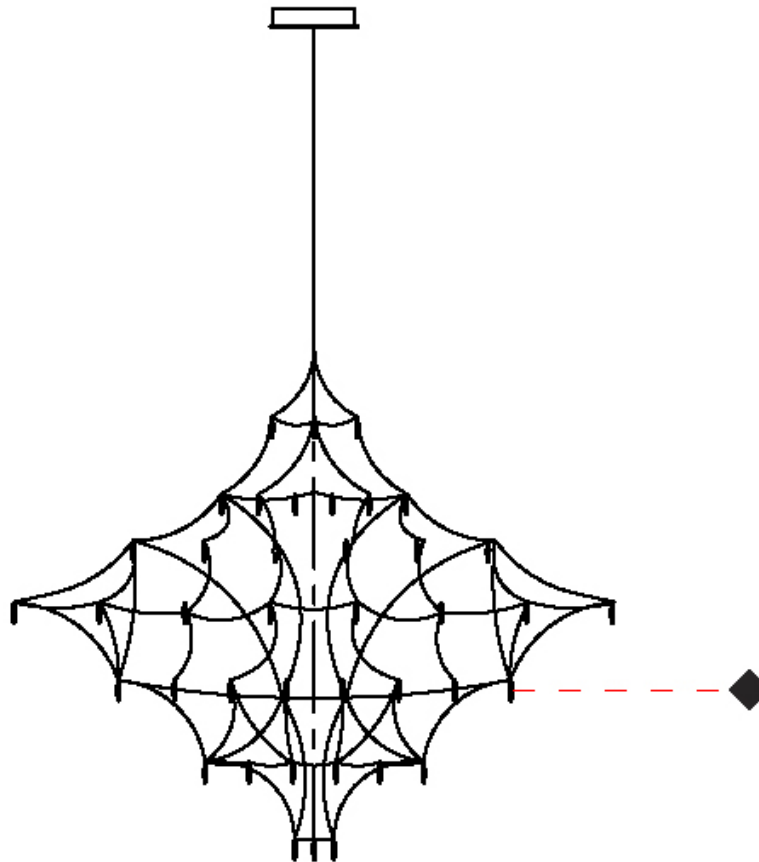

D

MIRA SUSPENSION

D101516-

base number LED Dimming Color Temperature Finish Options

- To build a product code in our configurator select the specify button on the base model # product page
- To build a manual product code on this datasheet choose from the options listed below in blue font and add the suffix to the base model #

GENERAL

Series: Mira
 Brand: Quasar
 Division: Design
 Mounting Type: Suspension
 Mounting Location: Ceiling
 Subcategory: Ambient

PHYSICAL

Shape: Abstract
 Diameter (mm): 1200
 Diameter (in): 47 1/4
 Height (mm): 1200
 Height (in): 47 1/4
 Max. Overall Height (mm): 3200
 Max. Overall Height (in): 126
 Light Distribution: Omnidirectional
 Weight (kg): 4
 Weight (lbs): 8.82
[Fixture Finish: NIC / BRA / BBR](#)
 Fixture Material: Metal
 Cable Details: 2000mm Cable
 Upon Request: Custom Sizes

ELECTRICAL

Lamp Type: LED
 Input Wattage (W): 41.4
[Dimming: Non-Dimming / Phase Dimming \(120vac Only\)](#)
 Driver Included: Yes
 Driver Location: Integrated
 Driver Type: Constant Voltage - Universal
 Driver Class: Class 2
 Input Voltage (V): 120 - 277
 Output Voltage (V): 12
 Upon Request: (Not included - see components) Integral: 0-10Vdc dimming

LED

Number of LEDs: 69
[Color Temperature \(°K\): 2400 / 2800](#)
 Max. Delivered Lumen (lm): 2070 (2800K)
 CRI: >97 CRI
 Lamp Life (hrs): 50000

OPTICAL

RATINGS AND CERTIFICATIONS

Certified By: Certified for North American Standards
 IP rating: IP20

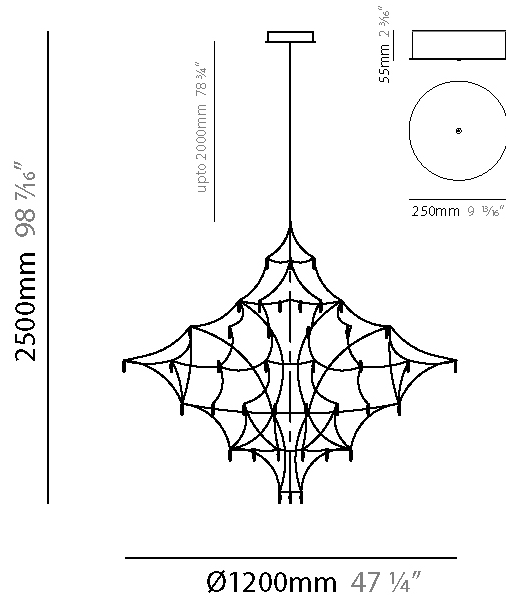

MIRA SUSPENSION

D101516-

PROJECT

TYPE

SPECIFIER

QUANTITY

DATE

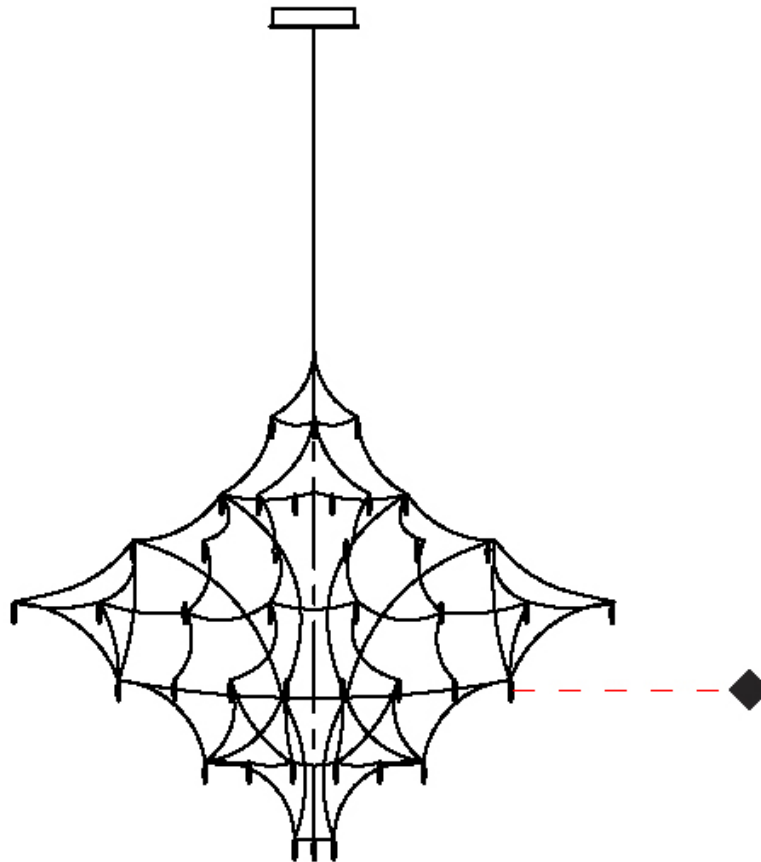

D

PROJECT	_____
TYPE	_____
SPECIFIER	_____
QUANTITY	_____
DATE	_____

MIRA SUSPENSION

D101517-

base number	LED	Color	Finish
	Dimming	Temperature	Options

- To build a product code in our configurator select the specify button on the base model # product page
- To build a manual product code on this datasheet choose from the options listed below in blue font and add the suffix to the base model #

GENERAL

Series: Mira
Brand: Quasar
Division: Design
Mounting Type: Suspension
Mounting Location: Ceiling
Subcategory: Ambient

PHYSICAL

Shape: Abstract
Diameter (mm): 1400
Diameter (in): 55 1/8"
Height (mm): 1400
Height (in): 55 1/8"
Max. Overall Height (mm): 3400
Max. Overall Height (in): 133 7/8"
Light Distribution: Omnidirectional
Weight (kg): 3
Weight (lbs): 13.23
Fixture Finish: NIC / BRA / BBR
Fixture Material: Metal
Cable Details: 2000mm Cable
Upon Request: Custom Sizes

ELECTRICAL

Lamp Type: LED
Input Wattage (W): 55.8
Dimming: Non-Dimming / Phase Dimming (120vac Only)
Driver Included: Yes
Driver Location: Integrated
Driver Type: Constant Voltage - Universal
Driver Class: Class 2
Input Voltage (V): 120 - 277
Output Voltage (V): 12
Upon Request: (Not included - see components) Integral: 0-10Vdc dimming

LED

Number of LEDs: 93
Color Temperature (°K): 2400 / 2800
Max. Delivered Lumen (lm): 2790 (2800K)
CRI: >95 CRI
Lamp Life (hrs): 50000

OPTICAL

RATINGS AND CERTIFICATIONS

Certified By: Certified for North American Standards
IP rating: IP20

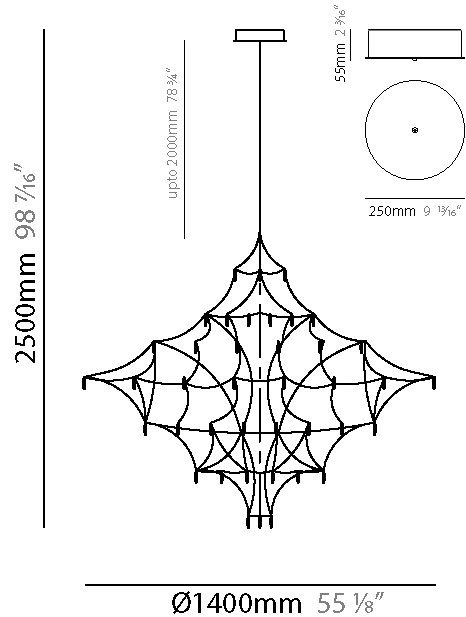

MIRA SUSPENSION

D101517-

PROJECT

TYPE

SPECIFIER

QUANTITY

DATE

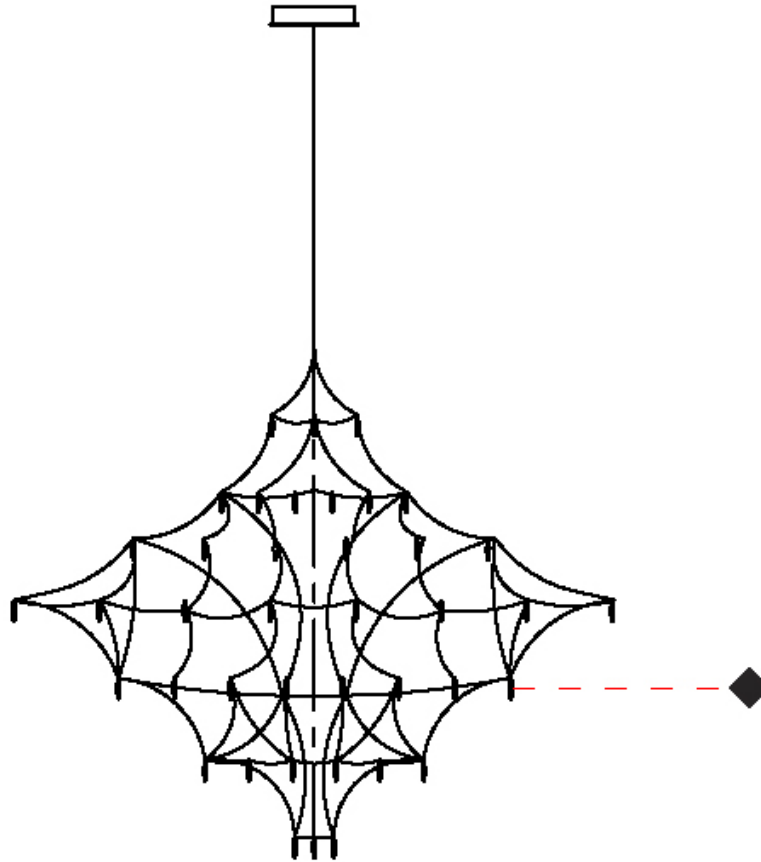

D

MIRA SUSPENSION

D101518-

base number LED Dimming Color Temperature Finish Options

- To build a product code in our configurator select the specify button on the base model # product page
- To build a manual product code on this datasheet choose from the options listed below in blue font and add the suffix to the base model #

GENERAL

Series: Mira
 Brand: Quasar
 Division: Design
 Mounting Type: Suspension
 Mounting Location: Ceiling
 Subcategory: Ambient

PHYSICAL

Shape: Abstract
 Diameter (mm): 1600
 Diameter (in): 63
 Height (mm): 1600
 Height (in): 63
 Max. Overall Height (mm): 3600
 Max. Overall Height (in): 141 3/4
 Light Distribution: Omnidirectional
 Weight (kg): 6
 Weight (lbs): 13.23
 Fixture Finish: [NIC / BRA / BBR](#)
 Fixture Material: Metal
 Cable Details: 2000mm Cable
 Upon Request: Custom Sizes

ELECTRICAL

Lamp Type: LED
 Input Wattage (W): 59.4
 Dimming: [Non-Dimming / Phase Dimming \(120vac Only\)](#)
 Driver Included: Yes
 Driver Location: Integrated
 Driver Type: Constant Voltage - Universal
 Driver Class: Class 2
 Input Voltage (V): 120 - 277
 Output Voltage (V): 12
 Upon Request: (Not included - see components) Integral: 0-10Vdc dimming

LED

Number of LEDs: 99
 Color Temperature (°K): [2400 / 2800](#)
 Max. Delivered Lumen (lm): 2970 (2800K)
 CRI: >97 CRI
 Lamp Life (hrs): 50000

OPTICAL

RATINGS AND CERTIFICATIONS

Certified By: Certified for North American Standards
 IP rating: IP20

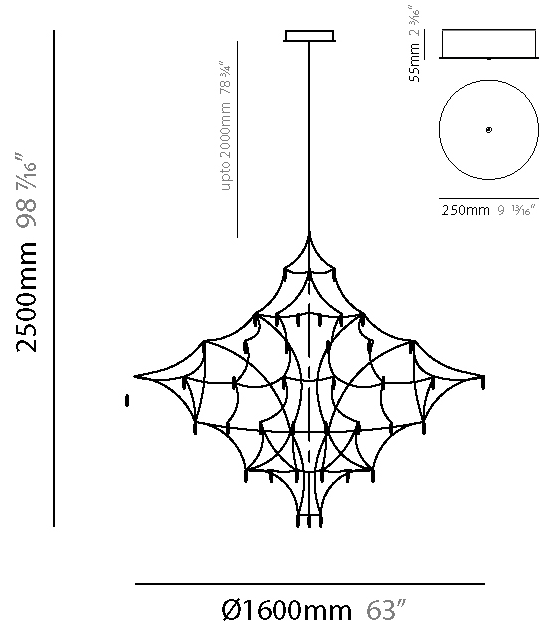

MIRA SUSPENSION

D101518-

PROJECT

TYPE

SPECIFIER

QUANTITY

DATE

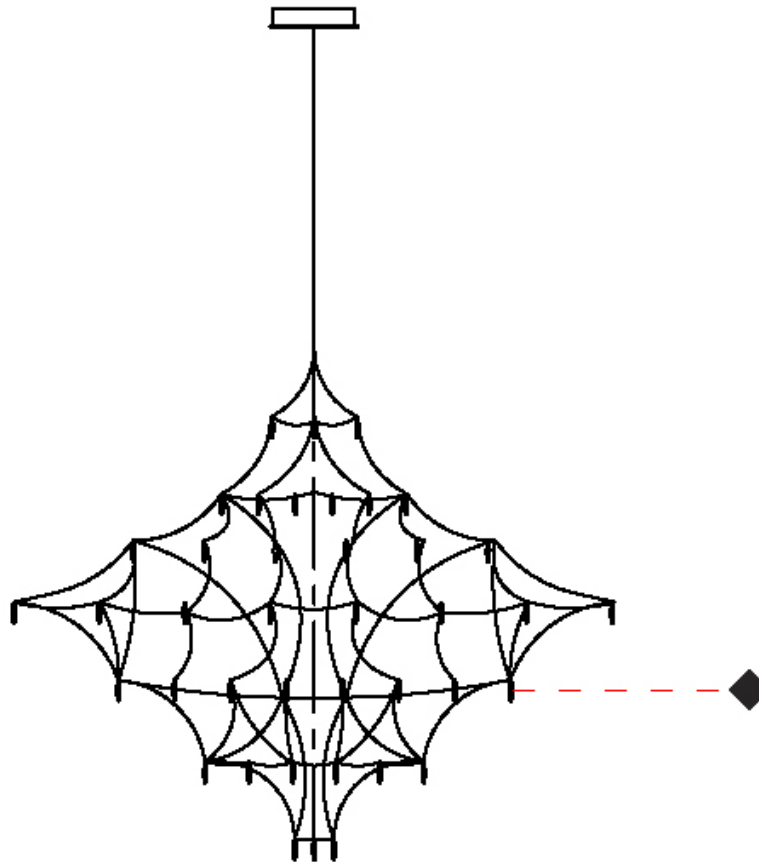

D

PROJECT	_____
TYPE	_____
SPECIFIER	_____
QUANTITY	_____
DATE	_____

MIRA SUSPENSION

D101519-

base number	LED	Color	Finish
	Dimming	Temperature	Options

- To build a product code in our configurator select the specify button on the base model # product page
- To build a manual product code on this datasheet choose from the options listed below in blue font and add the suffix to the base model #

GENERAL

Series: Mira
Brand: Quasar
Division: Design
Mounting Type: Suspension
Mounting Location: Ceiling
Subcategory: Ambient

PHYSICAL

Shape: Abstract
Diameter (mm): 1800
Diameter (in): 70 7/8
Height (mm): 1800
Height (in): 70 7/8
Max. Overall Height (mm): 3800
Max. Overall Height (in): 149 5/8
Light Distribution: Omnidirectional
Weight (kg): 7
Weight (lbs): 15.43
Fixture Finish: NIC / BRA / BBR
Fixture Material: Metal
Cable Details: 2000mm Cable
Upon Request: Custom Sizes

ELECTRICAL

Lamp Type: LED
Input Wattage (W): 66.6
Dimming: Non-Dimming / Phase Dimming (120vac Only)
Driver Included: Yes
Driver Location: Integrated
Driver Type: Constant Voltage - Universal
Driver Class: Class 2
Input Voltage (V): 120 - 277
Output Voltage (V): 12
Upon Request: (Not included - see components) Integral: 0-10Vdc dimming

LED

Number of LEDs: 111
Color Temperature (°K): 2400 / 2800
Max. Delivered Lumen (lm): 3330 (2800K)
CRI: >97 CRI
Lamp Life (hrs): 50000

OPTICAL

RATINGS AND CERTIFICATIONS

Certified By: Certified for North American Standards
IP rating: IP20

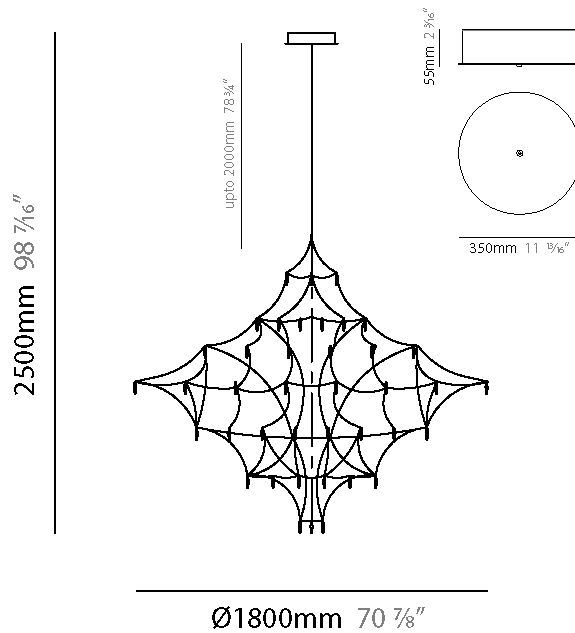

MIRA SUSPENSION

D101519-

PROJECT

TYPE

SPECIFIER

QUANTITY

DATE

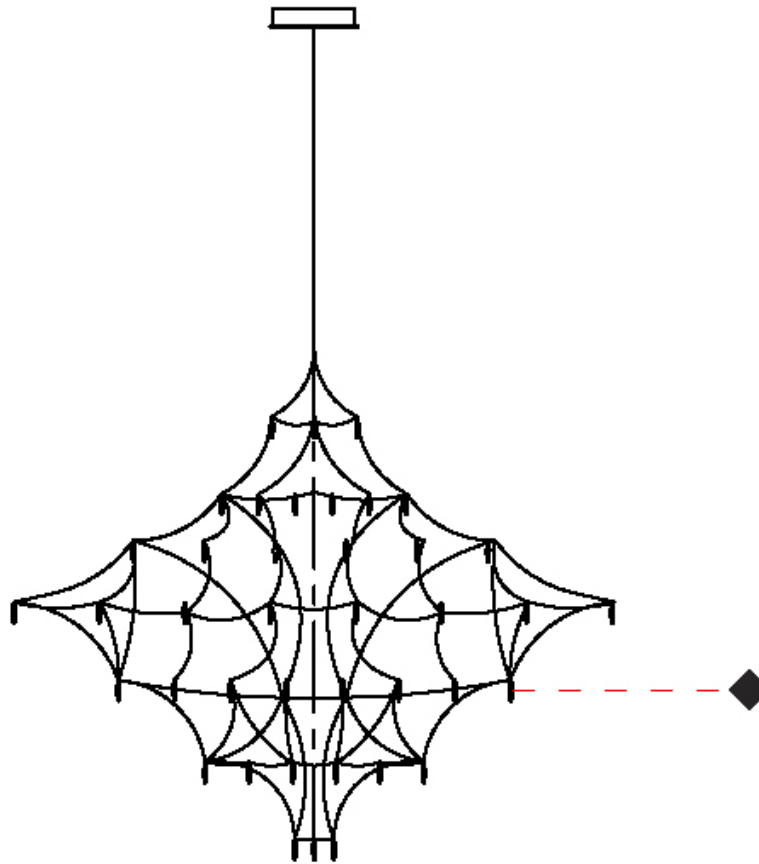

D

PROJECT	_____
TYPE	_____
SPECIFIER	_____
QUANTITY	_____
DATE	_____

MIRA SUSPENSION

D101520-

base number	LED	Color	Finish
	Dimming	Temperature	Options

- To build a product code in our configurator select the specify button on the base model # product page
- To build a manual product code on this datasheet choose from the options listed below in blue font and add the suffix to the base model #

GENERAL

Series: Mira
Brand: Quasar
Division: Design
Mounting Type: Suspension
Mounting Location: Ceiling
Subcategory: Ambient

PHYSICAL

Shape: Abstract
Diameter (mm): 2000
Diameter (in): 78 ¾
Height (mm): 2000
Height (in): 78 ¾
Max. Overall Height (mm): 4000
Max. Overall Height (in): 157 ½
Light Distribution: Omnidirectional
Weight (kg): 10
Fixture Finish: NIC / BRA / BBR
Fixture Material: Metal
Cable Details: 2000mm Cable
Upon Request: Custom Sizes

ELECTRICAL

Lamp Type: LED
Input Wattage (W): 90
Dimming: Non-Dimming / Phase Dimming (120vac Only)
Driver Included: Yes
Driver Location: Integrated
Driver Type: Constant Voltage - Universal
Driver Class: Class 2
Input Voltage (V): 120 - 277
Output Voltage (V): 12
Upon Request: (Not included - see components) Integral: 0-10Vdc dimming

LED

Number of LEDs: 150
Color Temperature (°K): 2400 / 2800
Max. Delivered Lumen (lm): 4500 (2800K)
CRI: >97 CRI
Lamp Life (hrs): 50000

OPTICAL

RATINGS AND CERTIFICATIONS

Certified By: Certified for North American Standards
IP rating: IP20

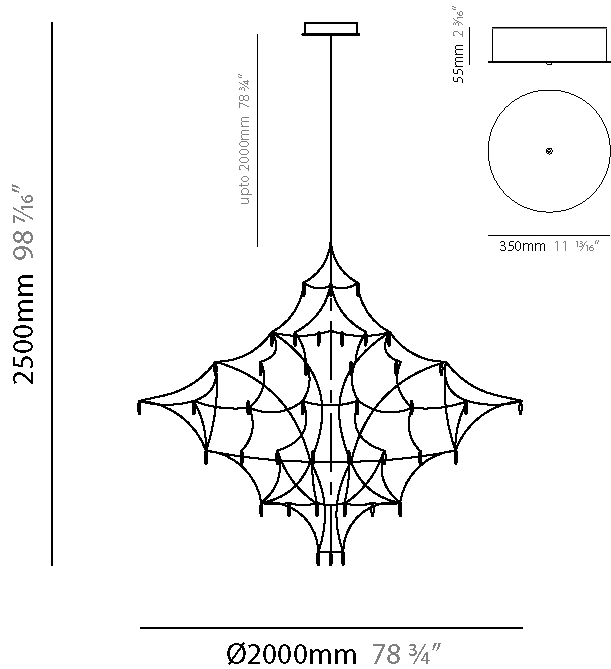

MIRA SUSPENSION

D101520-

PROJECT

TYPE

SPECIFIER

QUANTITY

DATE

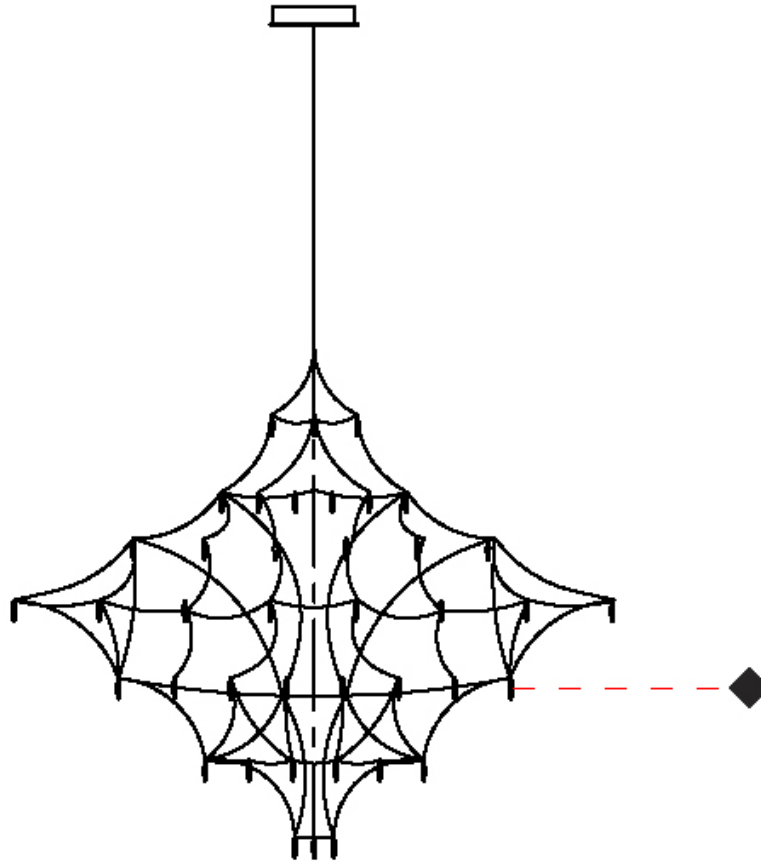

D

PROJECT	_____
TYPE	_____
SPECIFIER	_____
QUANTITY	_____
DATE	_____

MIRA SUSPENSION

D101621-

base number	LED	Color	Finish
	Dimming	Temperature	Options

- To build a product code in our configurator select the specify button on the base model # product page
- To build a manual product code on this datasheet choose from the options listed below in blue font and add the suffix to the base model #

GENERAL

Series: Mira
Brand: Quasar
Division: Design
Mounting Type: Suspension
Mounting Location: Ceiling
Subcategory: Ambient

PHYSICAL

Shape: Abstract
Diameter (mm): 800
Diameter (in): 31 1/2
Height (mm): 800
Height (in): 31 1/2
Max. Overall Height (mm): 2800
Max. Overall Height (in): 110 1/4
Light Distribution: Omnidirectional
Weight (kg): 4
Weight (lbs): 8.82
Fixture Finish: NIC / BRA / BBR
Fixture Material: Metal
Cable Details: 2000mm Cable
Upon Request: Custom Sizes

ELECTRICAL

Lamp Type: LED
Input Wattage (W): 19.8
Dimming: Non-Dimming / Phase Dimming (120vac Only)
Driver Included: Yes
Driver Location: Integrated
Driver Type: Constant Voltage - Universal
Driver Class: Class 2
Input Voltage (V): 120 - 277
Output Voltage (V): 12
Upon Request: Integral: 0-10Vdc dimming

LED

Number of LEDs: 33
Color Temperature (*K): 2400 / 2800
Max. Delivered Lumen (lm): 890 (2800K)
CRI: >97 CRI
Lamp Life (hrs): 50000

OPTICAL

RATINGS AND CERTIFICATIONS

Certified By: Certified for North American Standards
IP rating: IP20

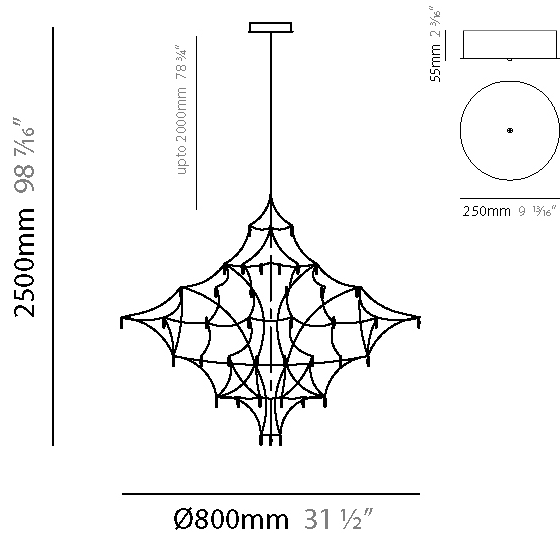

MIRA SUSPENSION

D101621-

PROJECT

TYPE

SPECIFIER

QUANTITY

DATE

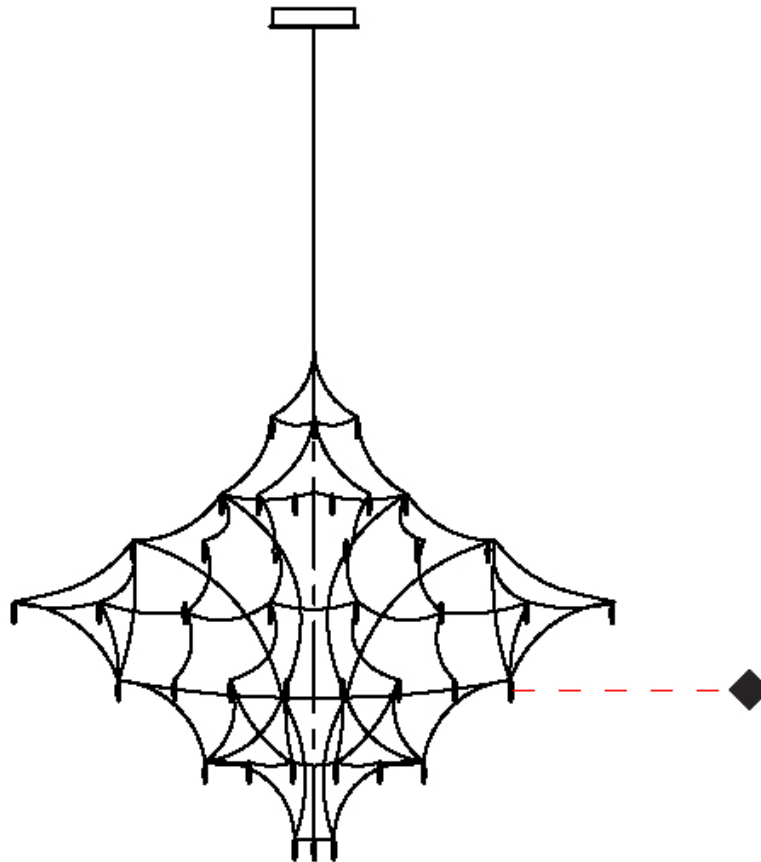

D

PROJECT	
TYPE	
SPECIFIER	
QUANTITY	
DATE	

MIRA SURFACE

D102023-

base number	LED	Color	Finish
	Dimming	Temperature	Options

- To build a product code in our configurator select the specify button on the base model # product page
- To build a manual product code on this datasheet choose from the options listed below in blue font and add the suffix to the base model #

GENERAL

Series: Mira
Brand: Quasar
Division: Design
Mounting Type: Surface
Mounting Location: Ceiling
Subcategory: Ambient

PHYSICAL

Shape: Abstract
Diameter (mm): 800
Diameter (in): 31 1/2
Height (mm): 550
Height (in): 21 5/8
Light Distribution: Omnidirectional
Weight (kg): 4
Weight (lbs): 8.82
Fixture Finish: NIC / BRA / BBR
Fixture Material: Metal
Upon Request: Custom Sizes

ELECTRICAL

Lamp Type: LED
Input Wattage (W): 16.2
Dimming: Non-Dimming / Phase Dimming (120vac Only)
Driver Included: Yes
Driver Location: Integrated
Driver Type: Constant Voltage - Universal
Driver Class: Class 2
Input Voltage (V): 120 - 277
Output Voltage (V): 12

LED

Number of LEDs: 27
Color Temperature (°K): 2400 / 2800
Max. Delivered Lumen (lm): 810 (2800K)
CRI: >97 CRI
Lamp Life (hrs): 50000

OPTICAL

RATINGS AND CERTIFICATIONS

Certified By: Certified for North American Standards
IP rating: IP20

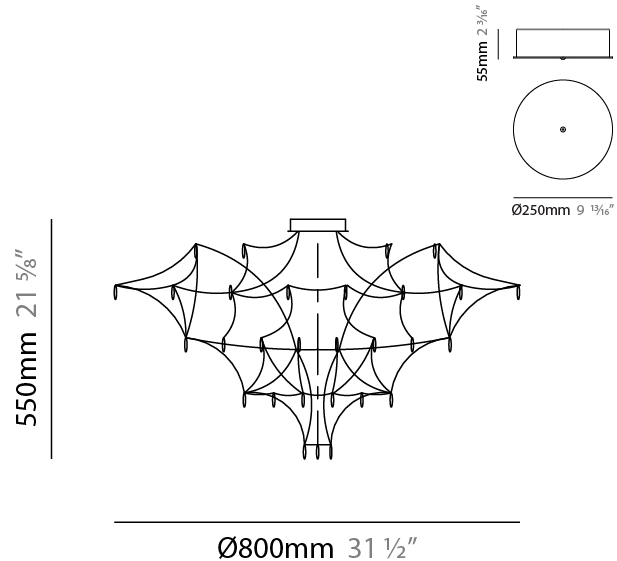

PROJECT	_____
TYPE	_____
SPECIFIER	_____
QUANTITY	_____
DATE	_____

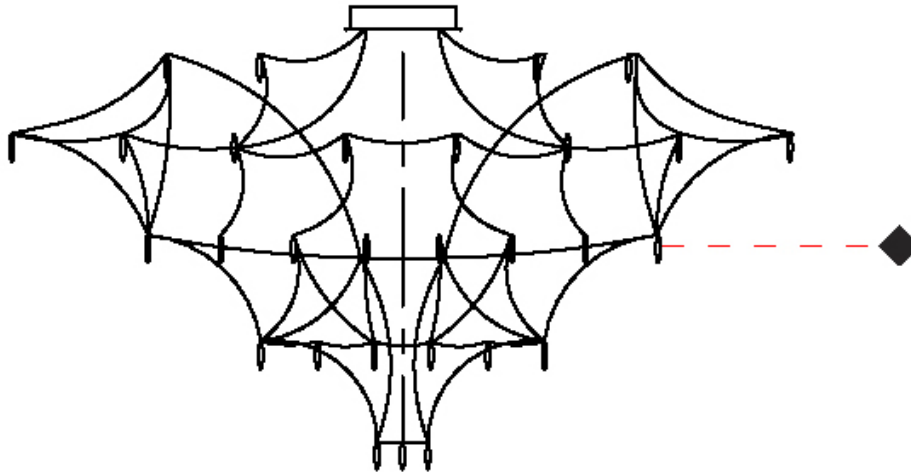

PROJECT	_____
TYPE	_____
SPECIFIER	_____
QUANTITY	_____
DATE	_____

MIRA SURFACE

D102024-

base number	LED	Color	Finish
	Dimming	Temperature	Options

- To build a product code in our configurator select the specify button on the base model # product page
- To build a manual product code on this datasheet choose from the options listed below in blue font and add the suffix to the base model #

GENERAL

Series: Mira
Brand: Quasar
Division: Design
Mounting Type: Surface
Mounting Location: Ceiling
Subcategory: Ambient

PHYSICAL

Shape: Abstract
Diameter (mm): 1000
Diameter (in): 39 3/8
Height (mm): 600
Height (in): 23 5/8
Light Distribution: Omnidirectional
Weight (kg): 3
Weight (lbs): 6.61
Fixture Finish: NIC / BRA / BBR
Fixture Material: Metal
Upon Request: Custom Sizes

ELECTRICAL

Lamp Type: LED
Input Wattage (W): 25.2
Dimming: Non-Dimming / Phase Dimming (120vac Only)
Driver Included: Yes
Driver Location: Integrated
Driver Type: Constant Voltage - Universal
Driver Class: Class 2
Input Voltage (V): 120 - 277
Output Voltage (V): 12
Upon Request: (Not included - see components) Integral: 0-10Vdc dimming

LED

Number of LEDs: 42
Color Temperature (°K): 2400 / 2800
Max. Delivered Lumen (lm): 1260 (2800K)
CRI: >97 CRI
Lamp Life (hrs): 50000

OPTICAL

RATINGS AND CERTIFICATIONS

Certified By: Certified for North American Standards
IP rating: IP20

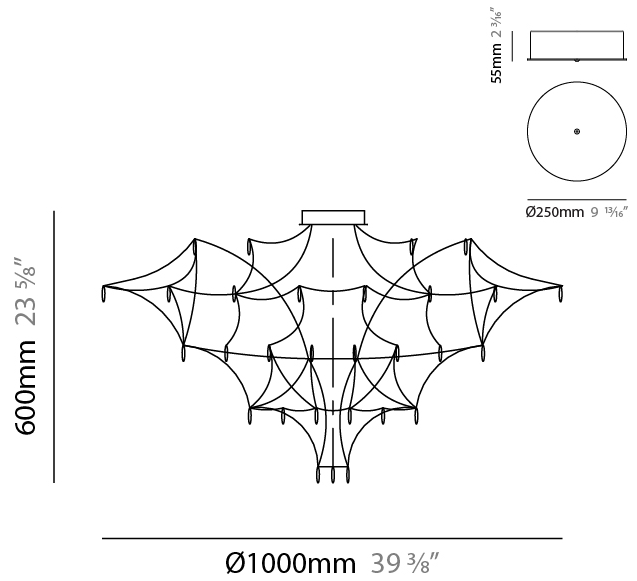

D102024-

PROJECT	_____
TYPE	_____
SPECIFIER	_____
QUANTITY	_____
DATE	_____

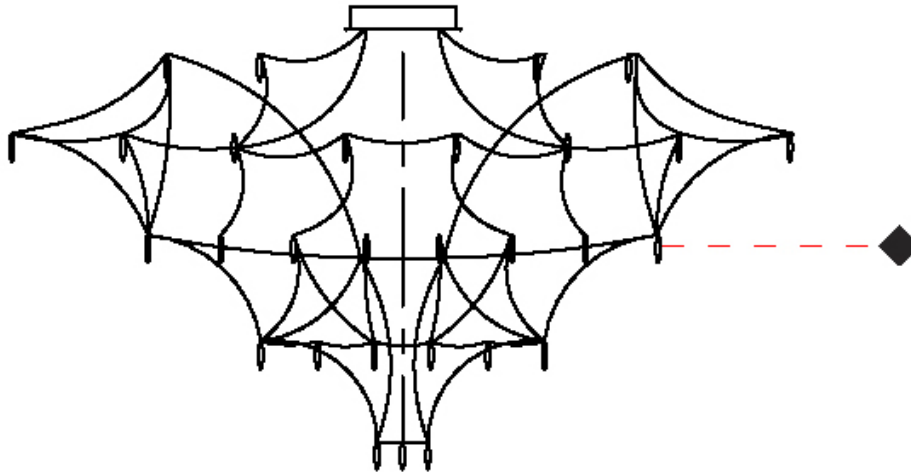

D

MIRA COLOR FINISH CHART

PROJECT _____

TYPE _____

SPECIFIER _____

QUANTITY _____

DATE _____

Fixture Finish

Nickel - NIC



Brass - BRA



Black Brass - BBR

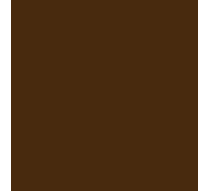

Digital: Not all screens are calibrated the same, and therefore, colors will appear differently between screens.

Physical: When texture is involved, there will be variations in color, character and tone within a product series and between product families.

Brass, nickel and copper are natural minerals and can potentially change color and show marks over time. We cannot guarantee the color appearance as the material transforms.



PROJECT	
TYPE	
SPECIFIER	
QUANTITY	
DATE	

LEGEND

floor-mounted	pivotal	special LED (upon request) RGB, RGBW, tunable, gold+, meat+, art+, fashion+
wall and ceiling: recessed and surface mounted	rotating	warm dim / natural dimming LED
ceiling-mounted and wall-mounted	illuminate tilted	rechargeable battery powered
wall-mounted	color of suspension cable	fixture with natural vivid LED (upon request)
omni-directional light distribution	length of suspension cable	color rendering index
direct light distribution	reflector degree selection	color temperature
direct/indirect light distribution	super spot	lumen (luminous flux)
indirect light distribution	lens	efficacy (lumens per watt)
asymmetric light distribution	lens pack	Unified Glare Rating (UGR) range from 5-40
aura light distribution	shine ring	marine grade (AISI 316 stainless steel)
round wall or ceiling cut-out	integrated shine ring with diffuser	walk on
square wall or ceiling cut-out	free individual colors 01-29	drive on
the supplied jig specifies the cutout dimensions	individual colors: 00 (free of charge), 01-25 (extra charge)	Dark Sky Compliance
minimum distance (meters) lamp - object	luminaire part to be colored (F1)	Americans with Disabilities Act (less than 4" off the wall located between 27"-84" from floor)
recessed depth	luminaire part to be colored (F2)	lamp protected against explosion
ceiling thickness in mm	luminaire part to be colored (F3)	blown glass using traditional methods by master glass blower
ceiling thickness selection	luminaire part to be colored (F4)	acoustic material
dimmable DP (phase), DV (0-10V), DD (dali), DS (step-dim)	luminaire part to be colored (F5)	protection class I, protection insulation
included or excluded LED driver/transformer/control gear	color of 3-circuit adaptor	protection class II, protection insulation
separately switchable	indirect diffuser	ETL Certified to UL and CSA Standards
sensor	direct diffuser	UL Certified to UL and CSA Standards
remote control	ball-proof (upon request)	CSA Certified to UL and CSA Standards
available upon request	accessory	Certified for North American Standards

IP RATING

IP20	protected against ingress of solid bodies greater than 12.5mm (finger)
IP33	protected against ingress of solid bodies greater than 2.5mm protected against sprays of water up to 60 degrees from the vertical (rain)
IP40	protected against ingress of solid bodies greater than 1mm (wire) no protection against the ingress of moisture
IP43	protected against ingress of solid bodies greater than 1mm (wire) protected against sprays of water up to 60 degrees from the vertical (rain)
IP44	protected against ingress of solid bodies greater than 1mm (wire) protected against water splashed from all directions
IP54	protected against limited ingress of dust (wet rooms/covered outdoor areas) protected against water splashed from all directions
IP65	protected against ingress of dust protected against jets of water
IP66	protected against ingress of dust protected against powerful jets of water or heavy seas
IP67	protected against ingress of dust protected against immersion of water between 15cm - 1m for 30 minutes
IP68	protected against ingress of dust protected against immersion of water under pressure for long periods

IK RATING

IK01	protected against 0.14 joules impact (equivalent to 0.25kg mass dropped from 56mm above the surface)
IK02	protected against 0.2 joules impact (equivalent to 0.25kg mass dropped from 80mm above the surface)
IK03	protected against 0.35 joules impact (equivalent to 0.25kg mass dropped from 140mm above the surface)
IK04	protected against 0.5 joules impact (equivalent to 0.25kg mass dropped from 200mm above the surface)
IK05	protected against 0.7 joules impact (equivalent to 0.25kg mass dropped from 280mm above the surface)
IK06	protected against 1 joules impact (equivalent to 0.25kg mass dropped from 400mm above the surface)
IK07	protected against 2 joules impact (equivalent to 0.5kg mass dropped from 400mm above the surface)
IK08	protected against 5 joules impact (equivalent to 1.7kg mass dropped from 300mm above the surface)
IK09	protected against 10 joules impact (equivalent to 5.0kg mass dropped from 200mm above the surface)
IK10	protected against 20 joules impact (equivalent to 5.0kg mass dropped from 400mm above the surface)