

| | |
|-----------|--|
| PROJECT | |
| TYPE | |
| SPECIFIER | |
| QUANTITY | |
| DATE | |

MIRA SUSPENSION

D101515-

| | | | |
|-------------|---------|-------------|---------|
| base number | LED | Color | Finish |
| | Dimming | Temperature | Options |

- To build a product code in our configurator select the specify button on the base model # product page
- To build a manual product code on this datasheet choose from the options listed below in blue font and add the suffix to the base model #

GENERAL

| |
|----------------------------|
| Series: Mira |
| Brand: Quasar |
| Division: Design |
| Mounting Type: Suspension |
| Mounting Location: Ceiling |
| Subcategory: Ambient |

PHYSICAL

| |
|---|
| Shape: Abstract |
| Diameter (mm): 1000 |
| Diameter (in): 39 ³ / ₈ |
| Height (mm): 1000 |
| Height (in): 39 ³ / ₈ |
| Max. Overall Height (mm): 3000 |
| Max. Overall Height (in): 118 ¹ / ₈ |
| Light Distribution: Omnidirectional |
| Weight (kg): 3 |
| Weight (lbs): 6.61 |
| Fixture Finish: NIC / BRA / BBR |
| Fixture Material: Metal |
| Cable Details: 2000mm Cable |
| Upon Request: Custom Sizes |

ELECTRICAL

| |
|---|
| Lamp Type: LED |
| Input Wattage (W): 28.8 |
| Dimming: Non-Dimming / Phase Dimming (120vac Only) |
| Driver Included: Yes |
| Driver Location: Integrated |
| Driver Type: Constant Voltage - Universal |
| Driver Class: Class 2 |
| Input Voltage (V): 120 - 277 |
| Output Voltage (V): 12 |
| Upon Request: (Not included - see components) Integral: 0-10Vdc dimming |

LED

| |
|---|
| Number of LEDs: 48 |
| Color Temperature (°K): 2400 / 2800 |
| Max. Delivered Lumen (lm): 1440 (2800K) |
| CRI: >97 CRI |
| Lamp Life (hrs): 50000 |

OPTICAL

RATINGS AND CERTIFICATIONS

| |
|--|
| Certified By: Certified for North American Standards |
| IP rating: IP20 |



MIRA SUSPENSION

D101515-

PROJECT

TYPE

SPECIFIER

QUANTITY

DATE



D

| | |
|-----------|-------|
| PROJECT | _____ |
| TYPE | _____ |
| SPECIFIER | _____ |
| QUANTITY | _____ |
| DATE | _____ |

MIRA SUSPENSION

D101516-

| | | | |
|-------------|---------|-------------|---------|
| base number | LED | Color | Finish |
| | Dimming | Temperature | Options |

- To build a product code in our configurator select the specify button on the base model # product page
- To build a manual product code on this datasheet choose from the options listed below in blue font and add the suffix to the base model #

GENERAL

| |
|----------------------------|
| Series: Mira |
| Brand: Quasar |
| Division: Design |
| Mounting Type: Suspension |
| Mounting Location: Ceiling |
| Subcategory: Ambient |

PHYSICAL

| |
|---|
| Shape: Abstract |
| Diameter (mm): 1200 |
| Diameter (in): 47 1/4 |
| Height (mm): 1200 |
| Height (in): 47 1/4 |
| Max. Overall Height (mm): 3200 |
| Max. Overall Height (in): 126 |
| Light Distribution: Omnidirectional |
| Weight (kg): 4 |
| Weight (lbs): 8.82 |
| Fixture Finish: NIC / BRA / BBR |
| Fixture Material: Metal |
| Cable Details: 2000mm Cable |
| Upon Request: Custom Sizes |

ELECTRICAL

| |
|---|
| Lamp Type: LED |
| Input Wattage (W): 41.4 |
| Dimming: Non-Dimming / Phase Dimming (120vac Only) |
| Driver Included: Yes |
| Driver Location: Integrated |
| Driver Type: Constant Voltage - Universal |
| Driver Class: Class 2 |
| Input Voltage (V): 120 - 277 |
| Output Voltage (V): 12 |
| Upon Request: (Not included - see components) Integral: 0-10Vdc dimming |

LED

| |
|---|
| Number of LEDs: 69 |
| Color Temperature (°K): 2400 / 2800 |
| Max. Delivered Lumen (lm): 2070 (2800K) |
| CRI: >97 CRI |
| Lamp Life (hrs): 50000 |

OPTICAL

RATINGS AND CERTIFICATIONS

| |
|--|
| Certified By: Certified for North American Standards |
| IP rating: IP20 |



MIRA SUSPENSION

D101516-

PROJECT

TYPE

SPECIFIER

QUANTITY

DATE

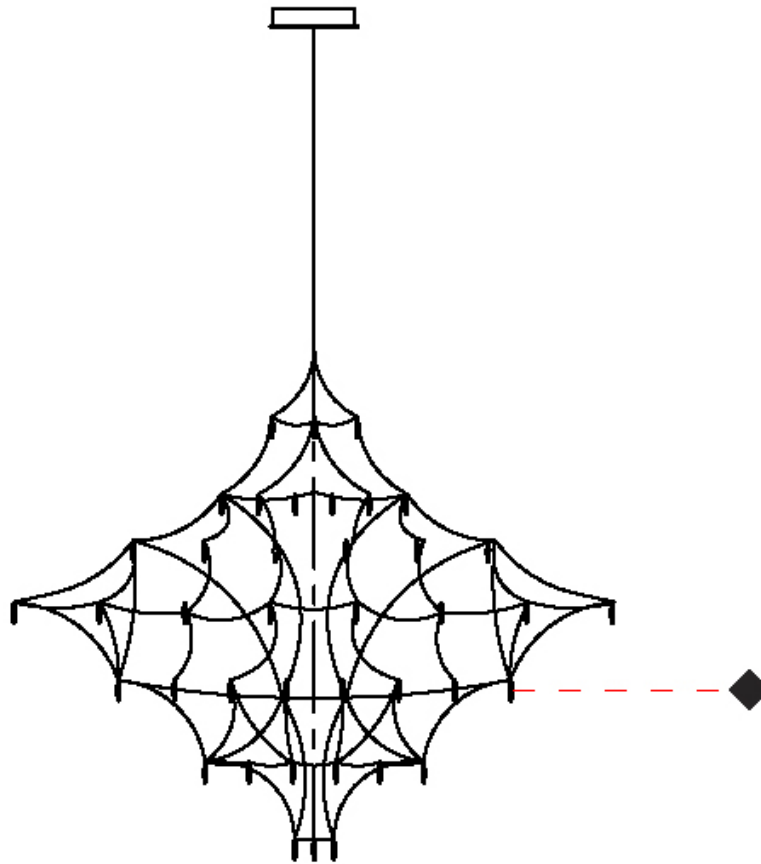

D

MIRA SUSPENSION

D101517-

base number LED Dimming Color Temperature Finish Options

- To build a product code in our configurator select the specify button on the base model # product page
- To build a manual product code on this datasheet choose from the options listed below in blue font and add the suffix to the base model #

GENERAL

Series: Mira
 Brand: Quasar
 Division: Design
 Mounting Type: Suspension
 Mounting Location: Ceiling
 Subcategory: Ambient

PHYSICAL

Shape: Abstract
 Diameter (mm): 1400
 Diameter (in): 55 1/8"
 Height (mm): 1400
 Height (in): 55 1/8"
 Max. Overall Height (mm): 3400
 Max. Overall Height (in): 133 7/8"
 Light Distribution: Omnidirectional
 Weight (kg): 3
 Weight (lbs): 13.23
 Fixture Finish: [NIC / BRA / BBR](#)
 Fixture Material: Metal
 Cable Details: 2000mm Cable
 Upon Request: Custom Sizes

ELECTRICAL

Lamp Type: LED
 Input Wattage (W): 55.8
 Dimming: [Non-Dimming / Phase Dimming \(120vac Only\)](#)
 Driver Included: Yes
 Driver Location: Integrated
 Driver Type: Constant Voltage - Universal
 Driver Class: Class 2
 Input Voltage (V): 120 - 277
 Output Voltage (V): 12
 Upon Request: (Not included - see components) Integral: 0-10Vdc dimming

LED

Number of LEDs: 93
 Color Temperature (°K): [2400 / 2800](#)
 Max. Delivered Lumen (lm): 2790 (2800K)
 CRI: >95 CRI
 Lamp Life (hrs): 50000

OPTICAL

RATINGS AND CERTIFICATIONS

Certified By: Certified for North American Standards
 IP rating: IP20

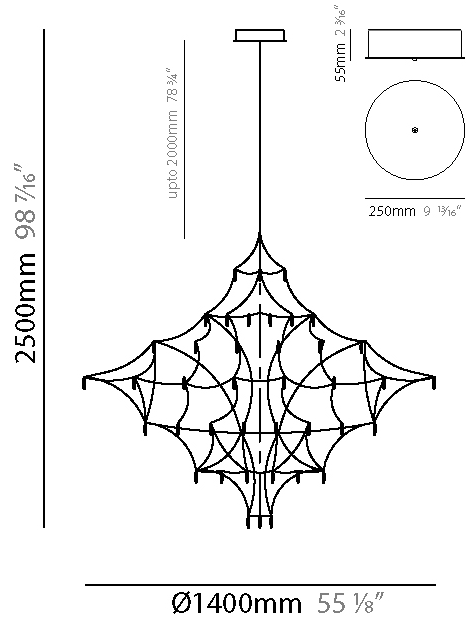

MIRA SUSPENSION

D101517-

PROJECT

TYPE

SPECIFIER

QUANTITY

DATE



D

| | |
|-----------|--|
| PROJECT | |
| TYPE | |
| SPECIFIER | |
| QUANTITY | |
| DATE | |

MIRA SUSPENSION

D101518-

| | | | |
|-------------|-------------|-------------------|----------------|
| base number | LED Dimming | Color Temperature | Finish Options |
|-------------|-------------|-------------------|----------------|

- To build a product code in our configurator select the specify button on the base model # product page
- To build a manual product code on this datasheet choose from the options listed below in blue font and add the suffix to the base model #

GENERAL

| |
|----------------------------|
| Series: Mira |
| Brand: Quasar |
| Division: Design |
| Mounting Type: Suspension |
| Mounting Location: Ceiling |
| Subcategory: Ambient |

PHYSICAL

| |
|---|
| Shape: Abstract |
| Diameter (mm): 1600 |
| Diameter (in): 63 |
| Height (mm): 1600 |
| Height (in): 63 |
| Max. Overall Height (mm): 3600 |
| Max. Overall Height (in): 141 3/4 |
| Light Distribution: Omnidirectional |
| Weight (kg): 6 |
| Weight (lbs): 13.23 |
| Fixture Finish: NIC / BRA / BBR |
| Fixture Material: Metal |
| Cable Details: 2000mm Cable |
| Upon Request: Custom Sizes |

ELECTRICAL

| |
|---|
| Lamp Type: LED |
| Input Wattage (W): 59.4 |
| Dimming: Non-Dimming / Phase Dimming (120vac Only) |
| Driver Included: Yes |
| Driver Location: Integrated |
| Driver Type: Constant Voltage - Universal |
| Driver Class: Class 2 |
| Input Voltage (V): 120 - 277 |
| Output Voltage (V): 12 |
| Upon Request: (Not included - see components) Integral: 0-10Vdc dimming |

LED

| |
|---|
| Number of LEDs: 99 |
| Color Temperature (°K): 2400 / 2800 |
| Max. Delivered Lumen (lm): 2970 (2800K) |
| CRI: >97 CRI |
| Lamp Life (hrs): 50000 |

OPTICAL

RATINGS AND CERTIFICATIONS

| |
|--|
| Certified By: Certified for North American Standards |
| IP rating: IP20 |

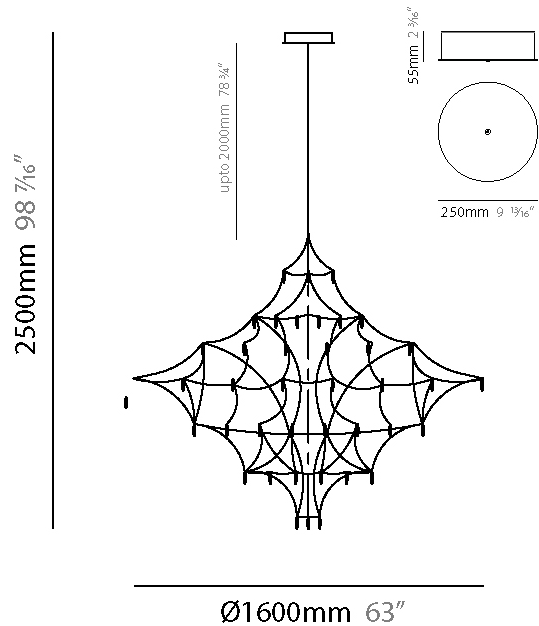

MIRA SUSPENSION

D101518-

PROJECT

TYPE

SPECIFIER

QUANTITY

DATE

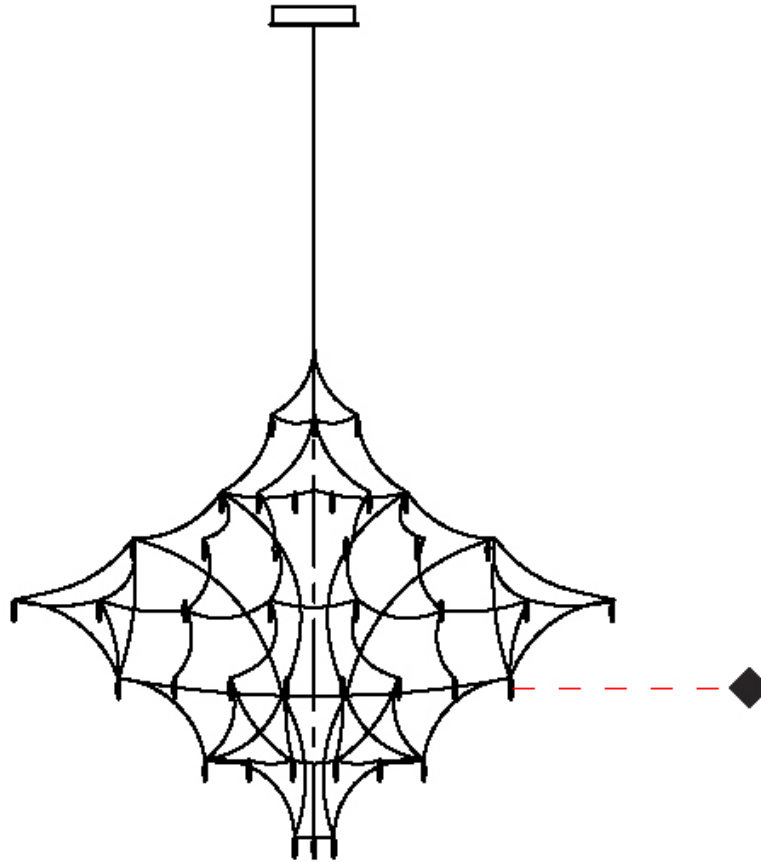

D

| | |
|-----------|-------|
| PROJECT | _____ |
| TYPE | _____ |
| SPECIFIER | _____ |
| QUANTITY | _____ |
| DATE | _____ |

MIRA SUSPENSION

D101519-

| | | | |
|-------------|---------|-------------|---------|
| base number | LED | Color | Finish |
| | Dimming | Temperature | Options |

- To build a product code in our configurator select the specify button on the base model # product page
- To build a manual product code on this datasheet choose from the options listed below in blue font and add the suffix to the base model #

GENERAL

| |
|----------------------------|
| Series: Mira |
| Brand: Quasar |
| Division: Design |
| Mounting Type: Suspension |
| Mounting Location: Ceiling |
| Subcategory: Ambient |

PHYSICAL

| |
|-------------------------------------|
| Shape: Abstract |
| Diameter (mm): 1800 |
| Diameter (in): 70 7/8 |
| Height (mm): 1800 |
| Height (in): 70 7/8 |
| Max. Overall Height (mm): 3800 |
| Max. Overall Height (in): 149 5/8 |
| Light Distribution: Omnidirectional |
| Weight (kg): 7 |
| Weight (lbs): 15.43 |
| Fixture Finish: NIC / BRA / BBR |
| Fixture Material: Metal |
| Cable Details: 2000mm Cable |
| Upon Request: Custom Sizes |

ELECTRICAL

| |
|---|
| Lamp Type: LED |
| Input Wattage (W): 66.6 |
| Dimming: Non-Dimming / Phase Dimming (120vac Only) |
| Driver Included: Yes |
| Driver Location: Integrated |
| Driver Type: Constant Voltage - Universal |
| Driver Class: Class 2 |
| Input Voltage (V): 120 - 277 |
| Output Voltage (V): 12 |
| Upon Request: (Not included - see components) Integral: 0-10Vdc dimming |

LED

| |
|---|
| Number of LEDs: 111 |
| Color Temperature (°K): 2400 / 2800 |
| Max. Delivered Lumen (lm): 3330 (2800K) |
| CRI: >97 CRI |
| Lamp Life (hrs): 50000 |

OPTICAL

RATINGS AND CERTIFICATIONS

| |
|--|
| Certified By: Certified for North American Standards |
| IP rating: IP20 |



MIRA SUSPENSION

D101519-

PROJECT

TYPE

SPECIFIER

QUANTITY

DATE



D

| | |
|-----------|-------|
| PROJECT | _____ |
| TYPE | _____ |
| SPECIFIER | _____ |
| QUANTITY | _____ |
| DATE | _____ |

MIRA SUSPENSION

D101520-

| | | | |
|-------------|---------|-------------|---------|
| base number | LED | Color | Finish |
| | Dimming | Temperature | Options |

- To build a product code in our configurator select the specify button on the base model # product page
- To build a manual product code on this datasheet choose from the options listed below in blue font and add the suffix to the base model #

GENERAL

| |
|----------------------------|
| Series: Mira |
| Brand: Quasar |
| Division: Design |
| Mounting Type: Suspension |
| Mounting Location: Ceiling |
| Subcategory: Ambient |

PHYSICAL

| |
|---|
| Shape: Abstract |
| Diameter (mm): 2000 |
| Diameter (in): 78 ¾ |
| Height (mm): 2000 |
| Height (in): 78 ¾ |
| Max. Overall Height (mm): 4000 |
| Max. Overall Height (in): 157 ½ |
| Light Distribution: Omnidirectional |
| Weight (kg): 10 |
| Fixture Finish: NIC / BRA / BBR |
| Fixture Material: Metal |
| Cable Details: 2000mm Cable |
| Upon Request: Custom Sizes |

ELECTRICAL

| |
|--|
| Lamp Type: LED |
| Input Wattage (W): 90 |
| Dimming: Non-Dimming / Phase Dimming (120vac Only) |
| Driver Included: Yes |
| Driver Location: Integrated |
| Driver Type: Constant Voltage - Universal |
| Driver Class: Class 2 |
| Input Voltage (V): 120 - 277 |
| Output Voltage (V): 12 |
| Upon Request: (Not included - see components) Integral: 0-10Vdc dimming |

LED

| |
|---|
| Number of LEDs: 150 |
| Color Temperature (°K): 2400 / 2800 |
| Max. Delivered Lumen (lm): 4500 (2800K) |
| CRI: >97 CRI |
| Lamp Life (hrs): 50000 |

OPTICAL

RATINGS AND CERTIFICATIONS

| |
|--|
| Certified By: Certified for North American Standards |
| IP rating: IP20 |

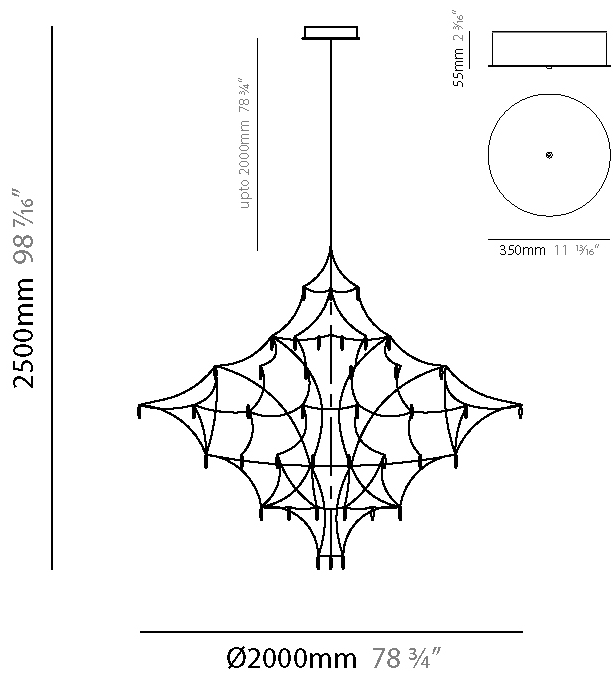

MIRA SUSPENSION

D101520-

PROJECT

TYPE

SPECIFIER

QUANTITY

DATE

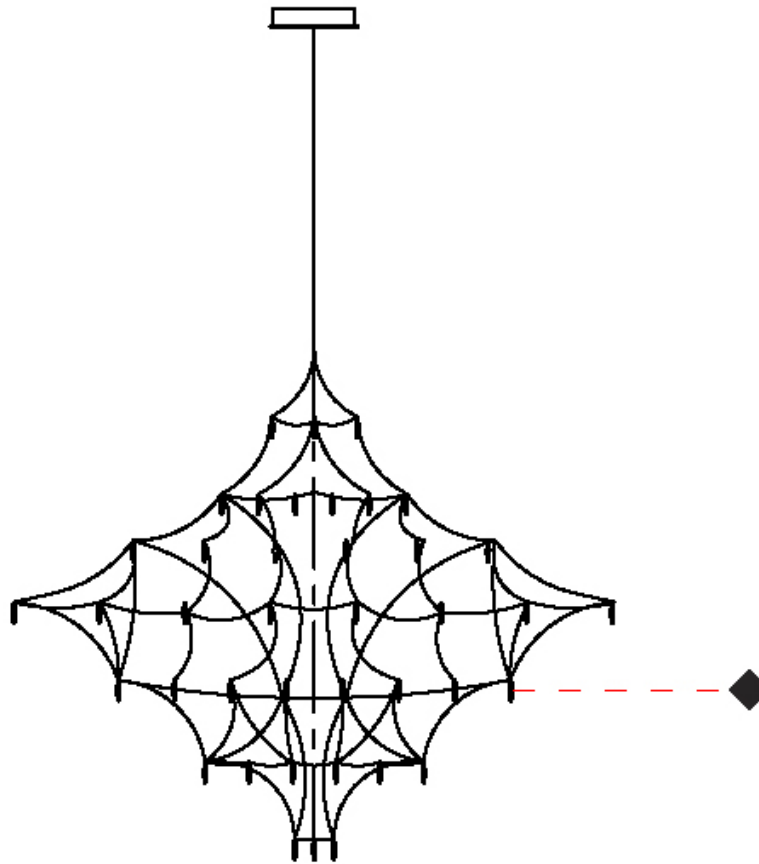

D

| | |
|-----------|--|
| PROJECT | |
| TYPE | |
| SPECIFIER | |
| QUANTITY | |
| DATE | |

MIRA SUSPENSION

D101621-

| | | | |
|-------------|-------------|-------------------|----------------|
| base number | LED Dimming | Color Temperature | Finish Options |
|-------------|-------------|-------------------|----------------|

- To build a product code in our configurator select the specify button on the base model # product page
- To build a manual product code on this datasheet choose from the options listed below in blue font and add the suffix to the base model #

GENERAL

| |
|----------------------------|
| Series: Mira |
| Brand: Quasar |
| Division: Design |
| Mounting Type: Suspension |
| Mounting Location: Ceiling |
| Subcategory: Ambient |

PHYSICAL

| |
|---|
| Shape: Abstract |
| Diameter (mm): 800 |
| Diameter (in): 31 1/2 |
| Height (mm): 800 |
| Height (in): 31 1/2 |
| Max. Overall Height (mm): 2800 |
| Max. Overall Height (in): 110 1/4 |
| Light Distribution: Omnidirectional |
| Weight (kg): 4 |
| Weight (lbs): 8.82 |
| Fixture Finish: NIC / BRA / BBR |
| Fixture Material: Metal |
| Cable Details: 2000mm Cable |
| Upon Request: Custom Sizes |

ELECTRICAL

| |
|--|
| Lamp Type: LED |
| Input Wattage (W): 19.8 |
| Dimming: Non-Dimming / Phase Dimming (120vac Only) |
| Driver Included: Yes |
| Driver Location: Integrated |
| Driver Type: Constant Voltage - Universal |
| Driver Class: Class 2 |
| Input Voltage (V): 120 - 277 |
| Output Voltage (V): 12 |
| Upon Request: Integral: 0-10Vdc dimming |

LED

| |
|---|
| Number of LEDs: 33 |
| Color Temperature (°K): 2400 / 2800 |
| Max. Delivered Lumen (lm): 890 (2800K) |
| CRI: >97 CRI |
| Lamp Life (hrs): 50000 |

OPTICAL

RATINGS AND CERTIFICATIONS

| |
|--|
| Certified By: Certified for North American Standards |
| IP rating: IP20 |



MIRA SUSPENSION

D101621-

PROJECT

TYPE

SPECIFIER

QUANTITY

DATE



D

| | |
|-----------|-------|
| PROJECT | _____ |
| TYPE | _____ |
| SPECIFIER | _____ |
| QUANTITY | _____ |
| DATE | _____ |

MIRA SURFACE

D102023-

| | | | |
|-------------|---------|-------------|---------|
| base number | LED | Color | Finish |
| | Dimming | Temperature | Options |

- To build a product code in our configurator select the specify button on the base model # product page
- To build a manual product code on this datasheet choose from the options listed below in blue font and add the suffix to the base model #

GENERAL

| |
|----------------------------|
| Series: Mira |
| Brand: Quasar |
| Division: Design |
| Mounting Type: Surface |
| Mounting Location: Ceiling |
| Subcategory: Ambient |

PHYSICAL

| |
|---|
| Shape: Abstract |
| Diameter (mm): 800 |
| Diameter (in): 31 1/2 |
| Height (mm): 550 |
| Height (in): 21 5/8 |
| Light Distribution: Omnidirectional |
| Weight (kg): 4 |
| Weight (lbs): 8.82 |
| Fixture Finish: NIC / BRA / BBR |
| Fixture Material: Metal |
| Upon Request: Custom Sizes |

ELECTRICAL

| |
|--|
| Lamp Type: LED |
| Input Wattage (W): 16.2 |
| Dimming: Non-Dimming / Phase Dimming (120vac Only) |
| Driver Included: Yes |
| Driver Location: Integrated |
| Driver Type: Constant Voltage - Universal |
| Driver Class: Class 2 |
| Input Voltage (V): 120 - 277 |
| Output Voltage (V): 12 |

LED

| |
|---|
| Number of LEDs: 27 |
| Color Temperature (°K): 2400 / 2800 |
| Max. Delivered Lumen (lm): 810 (2800K) |
| CRI: >97 CRI |
| Lamp Life (hrs): 50000 |

OPTICAL

RATINGS AND CERTIFICATIONS

| |
|--|
| Certified By: Certified for North American Standards |
| IP rating: IP20 |

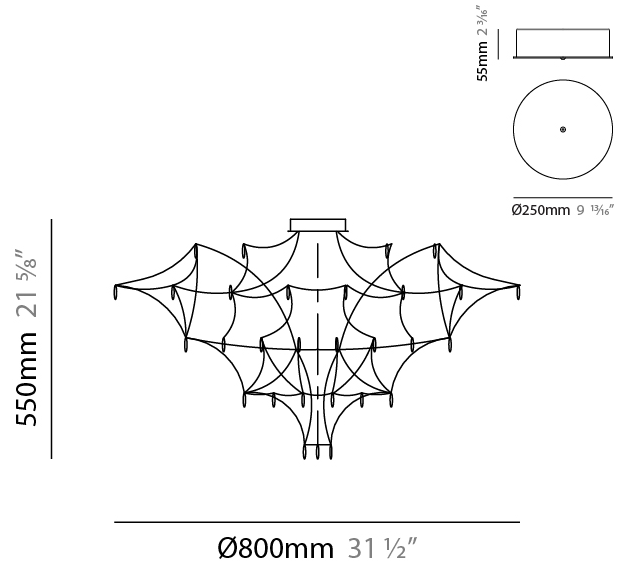

| | |
|-----------|-------|
| PROJECT | _____ |
| TYPE | _____ |
| SPECIFIER | _____ |
| QUANTITY | _____ |
| DATE | _____ |

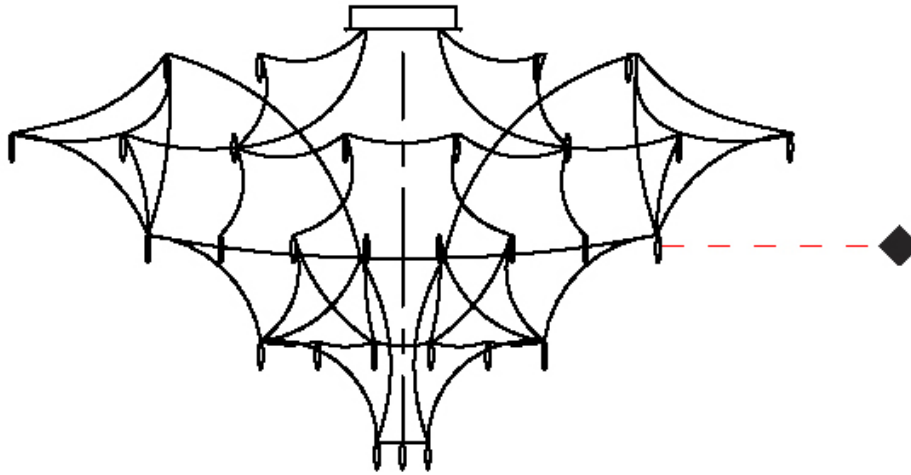

| | |
|-----------|-------|
| PROJECT | _____ |
| TYPE | _____ |
| SPECIFIER | _____ |
| QUANTITY | _____ |
| DATE | _____ |

MIRA SURFACE

D102024-

| | | | |
|-------------|---------|-------------|---------|
| base number | LED | Color | Finish |
| | Dimming | Temperature | Options |

- To build a product code in our configurator select the specify button on the base model # product page
- To build a manual product code on this datasheet choose from the options listed below in blue font and add the suffix to the base model #

GENERAL

| |
|----------------------------|
| Series: Mira |
| Brand: Quasar |
| Division: Design |
| Mounting Type: Surface |
| Mounting Location: Ceiling |
| Subcategory: Ambient |

PHYSICAL

| |
|---|
| Shape: Abstract |
| Diameter (mm): 1000 |
| Diameter (in): 39 3/8 |
| Height (mm): 600 |
| Height (in): 23 5/8 |
| Light Distribution: Omnidirectional |
| Weight (kg): 3 |
| Weight (lbs): 6.61 |
| Fixture Finish: NIC / BRA / BBR |
| Fixture Material: Metal |
| Upon Request: Custom Sizes |

ELECTRICAL

| |
|--|
| Lamp Type: LED |
| Input Wattage (W): 25.2 |
| Dimming: Non-Dimming / Phase Dimming (120vac Only) |
| Driver Included: Yes |
| Driver Location: Integrated |
| Driver Type: Constant Voltage - Universal |
| Driver Class: Class 2 |
| Input Voltage (V): 120 - 277 |
| Output Voltage (V): 12 |
| Upon Request: (Not included - see components) Integral: 0-10Vdc dimming |

LED

| |
|---|
| Number of LEDs: 42 |
| Color Temperature (°K): 2400 / 2800 |
| Max. Delivered Lumen (lm): 1260 (2800K) |
| CRI: >97 CRI |
| Lamp Life (hrs): 50000 |

OPTICAL

RATINGS AND CERTIFICATIONS

| |
|--|
| Certified By: Certified for North American Standards |
| IP rating: IP20 |



D102024-

| | |
|-----------|-------|
| PROJECT | _____ |
| TYPE | _____ |
| SPECIFIER | _____ |
| QUANTITY | _____ |
| DATE | _____ |

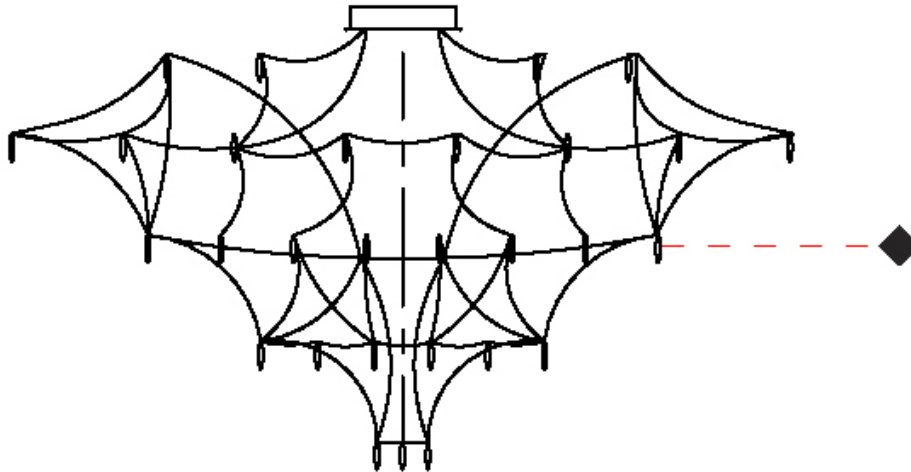

D

MIRA COLOR FINISH CHART

PROJECT _____

TYPE _____

SPECIFIER _____

QUANTITY _____

DATE _____

Fixture Finish

Nickel - NIC



Brass - BRA



Black Brass - BBR



Digital: Not all screens are calibrated the same, and therefore, colors will appear differently between screens.

Physical: When texture is involved, there will be variations in color, character and tone within a product series and between product families.

Brass, nickel and copper are natural minerals and can potentially change color and show marks over time. We cannot guarantee the color appearance as the material transforms.



| | |
|-----------|--|
| PROJECT | |
| TYPE | |
| SPECIFIER | |
| QUANTITY | |
| DATE | |

LEGEND

| | | |
|---|--|--|
| floor-mounted | pivotal | special LED (upon request) RGB, RGBW, tunable, gold+, meat+, art+, fashion+ |
| wall and ceiling: recessed and surface mounted | rotating | warm dim / natural dimming LED |
| ceiling-mounted and wall-mounted | illuminate tilted | rechargeable battery powered |
| wall-mounted | color of suspension cable | fixture with natural vivid LED (upon request) |
| omni-directional light distribution | length of suspension cable | color rendering index |
| direct light distribution | reflector degree selection | color temperature |
| direct/indirect light distribution | super spot | lumen (luminous flux) |
| indirect light distribution | lens | efficacy (lumens per watt) |
| asymmetric light distribution | lens pack | Unified Glare Rating (UGR) range from 5-40 |
| aura light distribution | shine ring | marine grade (AISI 316 stainless steel) |
| round wall or ceiling cut-out | integrated shine ring with diffuser | walk on |
| square wall or ceiling cut-out | free individual colors 01-29 | drive on |
| the supplied jig specifies the cutout dimensions | individual colors: 00 (free of charge), 01-25 (extra charge) | Dark Sky Compliance |
| minimum distance (meters) lamp - object | luminaire part to be colored (F1) | Americans with Disabilities Act (less than 4" off the wall located between 27"-84" from floor) |
| recessed depth | luminaire part to be colored (F2) | lamp protected against explosion |
| ceiling thickness in mm | luminaire part to be colored (F3) | blown glass using traditional methods by master glass blower |
| ceiling thickness selection | luminaire part to be colored (F4) | acoustic material |
| dimmable DP (phase), DV (0-10V), DD (dali), DS (step-dim) | luminaire part to be colored (F5) | protection class I, protection insulation |
| included or excluded LED driver/transformer/control gear | color of 3-circuit adaptor | protection class II, protection insulation |
| separately switchable | indirect diffuser | ETL Certified to UL and CSA Standards |
| sensor | direct diffuser | UL Certified to UL and CSA Standards |
| remote control | ball-proof (upon request) | CSA Certified to UL and CSA Standards |
| available upon request | accessory | Certified for North American Standards |

IP RATING

| | |
|------|--|
| IP20 | protected against ingress of solid bodies greater than 12.5mm (finger) |
| IP33 | protected against ingress of solid bodies greater than 2.5mm protected against sprays of water up to 60 degrees from the vertical (rain) |
| IP40 | protected against ingress of solid bodies greater than 1mm (wire) no protection against the ingress of moisture |
| IP43 | protected against ingress of solid bodies greater than 1mm (wire) protected against sprays of water up to 60 degrees from the vertical (rain) |
| IP44 | protected against ingress of solid bodies greater than 1mm (wire) protected against water splashed from all directions |
| IP54 | protected against limited ingress of dust (wet rooms/covered outdoor areas) protected against water splashed from all directions |
| IP65 | protected against ingress of dust protected against jets of water |
| IP66 | protected against ingress of dust protected against powerful jets of water or heavy seas |
| IP67 | protected against ingress of dust protected against immersion of water between 15cm - 1m for 30 minutes |
| IP68 | protected against ingress of dust protected against immersion of water under pressure for long periods |

IK RATING

| | |
|------|---|
| IK01 | protected against 0.14 joules impact (equivalent to 0.25kg mass dropped from 56mm above the surface) |
| IK02 | protected against 0.2 joules impact (equivalent to 0.25kg mass dropped from 80mm above the surface) |
| IK03 | protected against 0.35 joules impact (equivalent to 0.25kg mass dropped from 140mm above the surface) |
| IK04 | protected against 0.5 joules impact (equivalent to 0.25kg mass dropped from 200mm above the surface) |
| IK05 | protected against 0.7 joules impact (equivalent to 0.25kg mass dropped from 280mm above the surface) |
| IK06 | protected against 1 joules impact (equivalent to 0.25kg mass dropped from 400mm above the surface) |
| IK07 | protected against 2 joules impact (equivalent to 0.5kg mass dropped from 400mm above the surface) |
| IK08 | protected against 5 joules impact (equivalent to 1.7kg mass dropped from 300mm above the surface) |
| IK09 | protected against 10 joules impact (equivalent to 5.0kg mass dropped from 200mm above the surface) |
| IK10 | protected against 20 joules impact (equivalent to 5.0kg mass dropped from 400mm above the surface) |