

OLODUM ROUND RECESSED

E10I0019-

base number _____ Color _____
 Temperature _____

- To build a product code in our configurator select the specify button on the base model # product page
- To build a manual product code on this datasheet choose from the options listed below in blue font and add the suffix to the base model #

GENERAL

Series: Olodum
 Subseries: Olodum Round
 Brand: Side
 Division: Exterior
 Mounting Type: Recessed
 Mounting Location: In-Ground
 Subcategory: Uplight

PHYSICAL

Shape: Round
 Diameter (mm): 76
 Diameter (in): 3
 Height (mm): 62
 Height (in): 2 7/16
 Light Distribution: Uplight
 Weight (kg): 0.3
 Weight (lbs): 0.66
 Diffuser: Clear tempered glass
 Gasket: Silicon rubber
 Fixture Finish: SSS
 Fixture Material: Stainless Steel

ELECTRICAL

Lamp Type: LED (Zhaga Standard)
 Total Output Wattage (W): 3.5
 Dimming: Non-Dimming / Phase Dimming (120Vac only) / 0-10V Dimming
 Driver Included: No
 Driver Location: Remote
 Driver Type: Constant Current - 120 / 277Vac
 Driver Class: Class 2
 Input Voltage (V): 120 - 277
 Constant Current (MA): 350
 Upon Request: Dimming requires 2 fixture minimum

LED

Color Temperature (°K): 3000 / 4000
 Max. Delivered Lumen (lm): 285 / 300
 CRI: >80 CRI
 Lamp Life (hrs): 50000

OPTICAL

Reflector: Polycarbonate Metallized Reflector
 Optic: 45

RATINGS AND CERTIFICATIONS

Certified By: Certified for North American Standards
 IP rating: IP67
 IK Rating: IK07



0.30 kg / 0.66 lbs



OLODUM ROUND RECESSED

E10I0019-

PROJECT _____

TYPE _____

SPECIFIER _____

QUANTITY _____

DATE _____

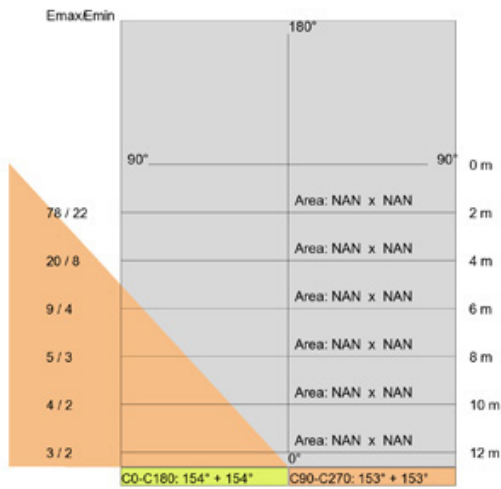

E

OLODUM RECESSED

E10I0047- _____ - _____

base number Color BA Options
 Temperature

- To build a product code in our configurator select the specify button on the base model # product page
- To build a manual product code on this datasheet choose from the options listed below in blue font and add the suffix to the base model #

GENERAL

Series: Olodum
 Brand: Side
 Division: Exterior
 Mounting Type: Recessed
 Mounting Location: In-Ground
 Subcategory: Drive Over

PHYSICAL

Shape: Round
 Diameter (mm): 220
 Diameter (in): 8 ¹¹/₁₆
 Height (mm): 242
 Height (in): 9 ¹/₂
 Light Distribution: Adjustable / Direct
 Weight (kg): 3.8
 Weight (lbs): 8.38
 Diffuser: Clear tempered glass
 Fixture Finish: SSS
 Fixture Material: Aluminum Die Cast

ELECTRICAL

Lamp Type: LED (Zhaga Standard)
 Input Wattage (W): 20
 Total Output Wattage (W): 17
 Dimming: Non-Dimming / Phase Dimming (120vac Only)
 Driver Included: Yes
 Driver Location: Integrated
 Driver Type: Constant Current - Universal
 Driver Class: Class 2
 Input Voltage (V): 120 - 277
 Constant Current (mA): 500
 Upon Request: (Not included - see components [IP65 or higher enclosure to be supplied by others]) Remote: 0-10Vdc dimming / (Included) Integral: Phase dimming @120Vac only / 277Vac

LED

Color Temperature (°K): 3000 / 4000
 Max. Delivered Lumen (lm): 2434.9 / 2607.5
 Nominal Lumen (lm): 2750 / 2945
 CRI: >80 CRI
 Lamp Life (hrs): 50000

OPTICAL

Reflector: Metallised polycarbonate reflector - Pivoting 350° and adjustable +/- 15° reflector
 Optic: 15 / 45 / 65 / ASY

RATINGS AND CERTIFICATIONS

Certified By: Certified for North American Standards
 IP rating: IP67
 IK Rating: IK10



3.80 kg / 8.38 lbs



PROJECT	
TYPE	
SPECIFIER	
QUANTITY	
DATE	

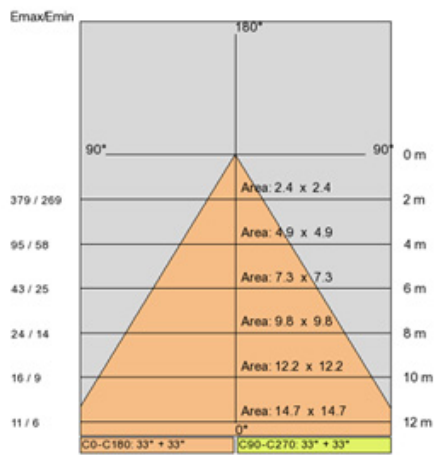

OLODUM RECESSED

E10I0059- _____ - _____

base number Color BA Options
 Temperature

- To build a product code in our configurator select the specify button on the base model # product page
- To build a manual product code on this datasheet choose from the options listed below in blue font and add the suffix to the base model #

GENERAL

Series: Olodum
 Brand: Side
 Division: Exterior
 Mounting Type: Recessed
 Mounting Location: In-Ground
 Subcategory: Uplight

PHYSICAL

Shape: Round
 Diameter (mm): 220
 Diameter (in): 8 11/16
 Height (mm): 242
 Height (in): 9 1/2
 Light Distribution: Adjustable / Direct
 Weight (kg): 3.8
 Weight (lbs): 8.38
 Diffuser: Clear tempered glass
 Gasket: Silicon rubber
 Fixture Finish: SSS
 Fixture Material: Aluminum Die Cast

ELECTRICAL

Lamp Type: LED (Zhaga Standard)
 Input Wattage (W): 20
 Total Output Wattage (W): 17
 Dimming: Tri-Mode (Non-Dimming and Phase Dimming (120Vac only) and 0-10V Dimming)
 Driver Included: Yes
 Driver Location: Integrated
 Driver Type: Constant Current - Universal
 Driver Class: Class 2
 Input Voltage (V): 120 - 277
 Constant Current (MA): 500
 Upon Request: (Not included - see components [IP65 or higher enclosure to be supplied by others]) Remote: 0-10Vdc dimming / (Included) Integral: Phase dimming @120Vac only / 277Vac

LED

Color Temperature (°K): 3000 / 4000
 Max. Delivered Lumen (lm): 2434.9 / 2607.5
 Nominal Lumen (lm): 2750 / 2945
 CRI: >80 CRI
 Lamp Life (hrs): 50000

OPTICAL

Reflector: Polycarbonate metallized reflector
 Optic: 15 / 45 / 65 / ASY

RATINGS AND CERTIFICATIONS

Certified By: Certified for North American Standards
 IP rating: IP67
 IK Rating: IK10

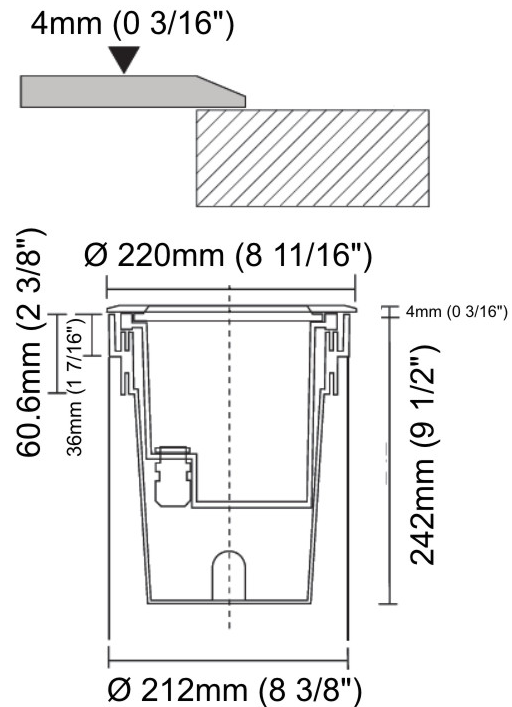

3.80 kg / 8.38 lbs



PROJECT	
TYPE	
SPECIFIER	
QUANTITY	
DATE	

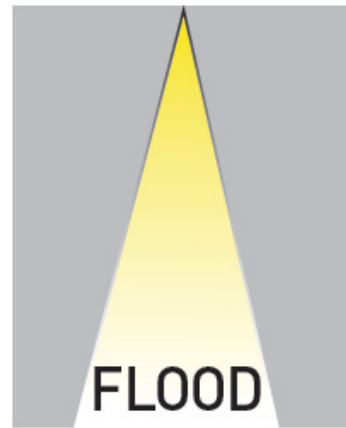

OLODUM ROUND RECESSED

E10I0071- -

base number Color BA Options
 Temperature

- To build a product code in our configurator select the specify button on the base model # product page
- To build a manual product code on this datasheet choose from the options listed below in blue font and add the suffix to the base model #

GENERAL

Series: Olodum
 Subseries: Olodum Round
 Brand: Side
 Division: Exterior
 Mounting Type: Recessed
 Mounting Location: In-Ground
 Subcategory: Uplight

PHYSICAL

Shape: Round
 Diameter (mm): 130
 Diameter (in): 5 1/8
 Height (mm): 146
 Height (in): 5 3/4
 Light Distribution: Adjustable / Direct
 Weight (kg): 1.9
 Weight (lbs): 4.19
 Diffuser: Clear tempered glass
 Gasket: Silicon rubber
 Fixture Finish: SSS
 Fixture Material: Aluminum Die Cast

ELECTRICAL

Lamp Type: LED (Zhaga Standard)
 Input Wattage (W): 6.8
 Total Output Wattage (W): 5.8
 Dimming: 0-10V Dimming / Phase Dimming (120Vac Only)
 Driver Included: No
 Driver Location: Remote
 Driver Type: Constant Current - Universal
 Input Voltage (V): 120 - 277
 Constant Current (MA): 203
 Upon Request: (Not included - see components [IP65 or higher enclosure to be supplied by others]) 0-10Vdc dimming / Phase dimming @120Vac only / 277Vac

LED

Color Temperature (°K): 3000 / 4000
 Max. Delivered Lumen (lm): 814.5 / 868.8
 Nominal Lumen (lm): 1050 / 1120
 CRI: >80 CRI
 Lamp Life (hrs): 50000

OPTICAL

Reflector: Metallized polycarbonate
 Optic: 15 / 30 / 45
 Adjustability: Rotational 350°; Tilt ±15°

RATINGS AND CERTIFICATIONS

Certified By: Certified for North American Standards
 IP rating: IP67
 IK Rating: IK10

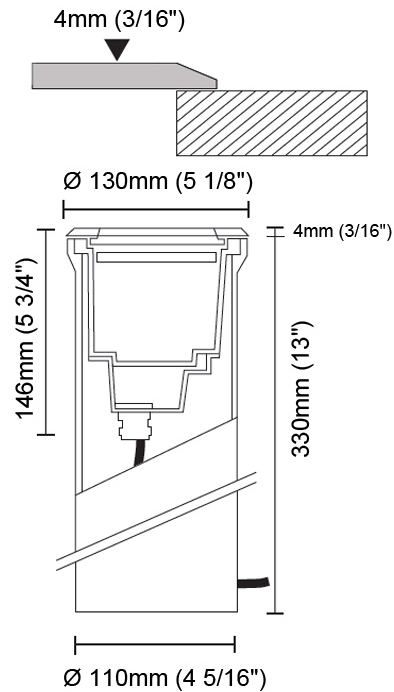

1.9kg / 4.19lbs



OLODUM ROUND RECESSED

E10I0071-

PROJECT	
TYPE	
SPECIFIER	
QUANTITY	
DATE	

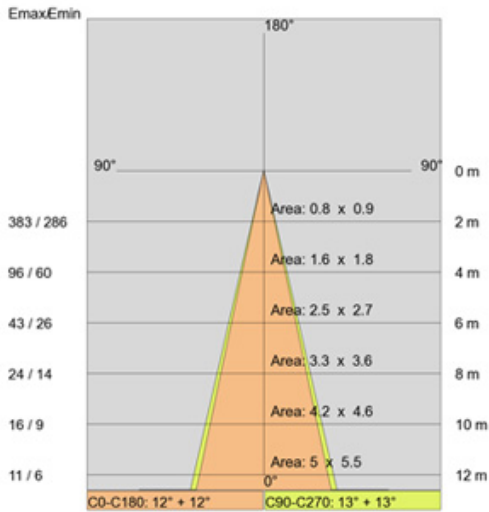
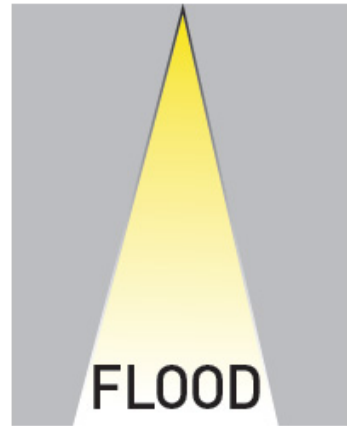
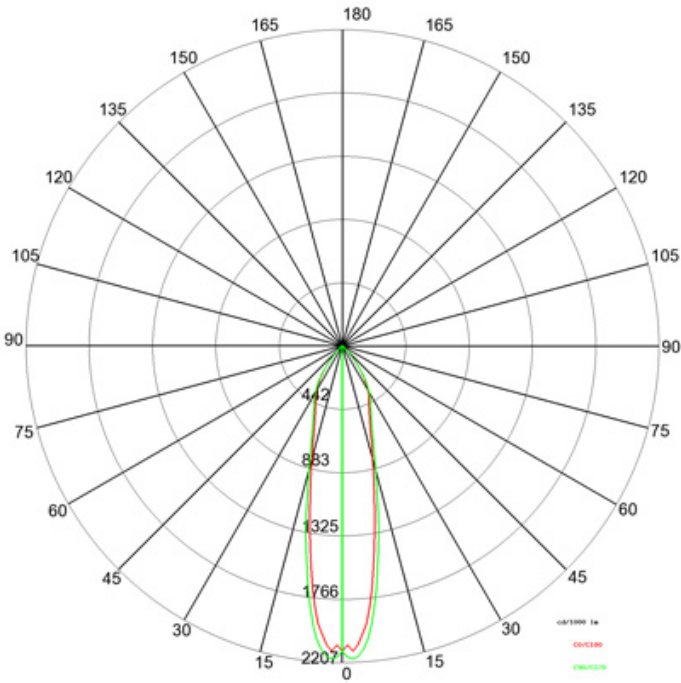

E

PROJECT
TYPE
SPECIFIER
QUANTITY
DATE

OLODUM ROUND RECESSED

E10I0093-

base number Color
Temperature

- To build a product code in our configurator select the specify button on the base model # product page
- To build a manual product code on this datasheet choose from the options listed below in blue font and add the suffix to the base model #

GENERAL

Series: Olodum
 Subseries: Olodum Round
 Brand: Side
 Division: Exterior
 Mounting Type: Recessed
 Mounting Location: In-Ground
 Subcategory: Walk Over

PHYSICAL

Shape: Round
 Diameter (mm): 65
 Diameter (in): 2 9/16
 Height (mm): 62
 Height (in): 2 7/16
 Light Distribution: Uplight
 Weight (kg): 0.3
 Weight (lbs): 0.66
 Load Resistance (kg): 500
 Load Resistance (lbs): 1102
 Diffuser: Clear tempered glass
 Gasket: Silicon rubber
 Fixture Finish: SSS
 Fixture Material: Stainless Steel

ELECTRICAL

Lamp Type: LED (Zhaga Standard)
 Input Wattage (W): 3.5
 Total Output Wattage (W): 3
 Driver Included: No
 Input Voltage (V): 120
 Constant Current (MA): 350

LED

Number of LEDs: 1
 Color Temperature (°K): 3000 / 4000
 Max. Delivered Lumen (lm): 285 / 300
 CRI: >80 CRI

OPTICAL

Reflector: Polycarbonate metallized reflector
 Optic: 45

RATINGS AND CERTIFICATIONS

Certified By: Certified for North American Standards
 IP rating: IP67
 IK Rating: IK07

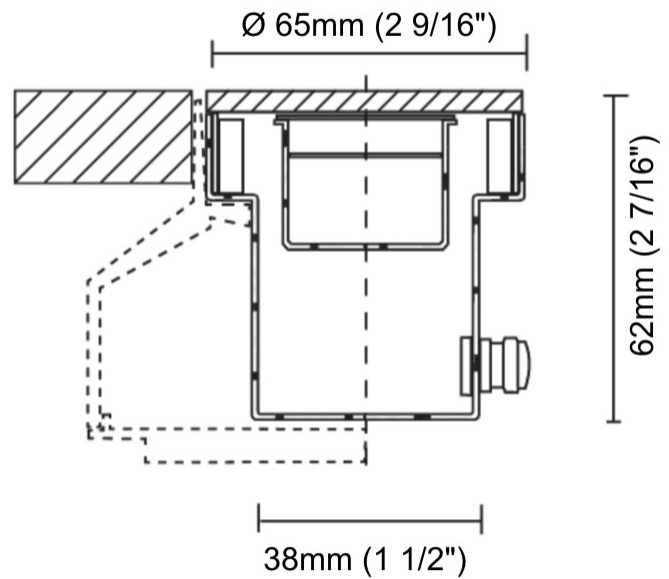

△ 0.3kg / 0.66lbs



OLODUM ROUND RECESSED

E10I0093-

PROJECT	
TYPE	
SPECIFIER	
QUANTITY	
DATE	

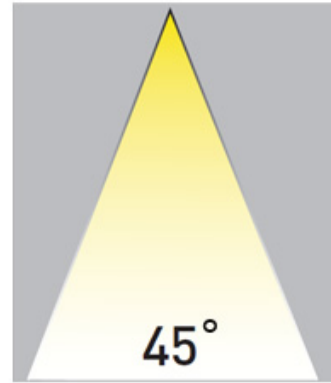
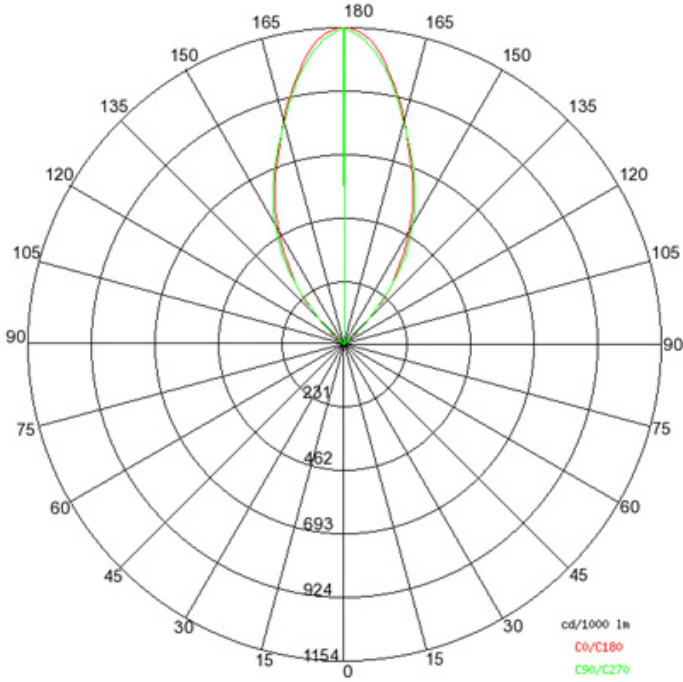

Emax/Emin	180°	
	90°	0 m
	90°	2 m
78 / 22	Area: NAN x NAN	4 m
20 / 8	Area: NAN x NAN	6 m
9 / 4	Area: NAN x NAN	8 m
5 / 3	Area: NAN x NAN	10 m
4 / 2	Area: NAN x NAN	12 m
3 / 2	Area: NAN x NAN	
	0°	
	C0-C180: 154° + 154°	
	C90-C270: 153° + 153°	



PROJECT	_____
TYPE	_____
SPECIFIER	_____
QUANTITY	_____
DATE	_____

OLODUM ROUND RECESSED

E10Q0034-

base number _____ Color _____
 Temperature _____

- To build a product code in our configurator select the specify button on the base model # product page
- To build a manual product code on this datasheet choose from the options listed below in blue font and add the suffix to the base model #

GENERAL

Series: Olodum
 Subseries: Olodum Round
 Brand: Side
 Division: Exterior
 Mounting Type: Recessed
 Mounting Location: Ceiling
 Subcategory: Downlight

PHYSICAL

Shape: Round
 Diameter (mm): 76
 Diameter (in): 3
 Height (mm): 58
 Height (in): 2 5/16
 Min. Recessing Depth (mm): 63
 Min. Recessing Depth (in): 2 1/2
 Light Distribution: Direct
 Weight (kg): 0.4
 Weight (lbs): 0.88
 Diffuser: Clear tempered glass
 Gasket: Silicon rubber
 Fixture Finish: SSS
 Fixture Material: Stainless Steel

ELECTRICAL

Lamp Type: LED (Zhaga Standard)
 Input Wattage (W): 4.4
 Total Output Wattage (W): 3.1
 Dimming: Non-Dimming / Phase Dimming (120Vac only) / 0-10V Dimming
 Driver Included: No
 Driver Location: Remote
 Driver Type: Constant Current - 120 / 277Vac
 Driver Class: Class 2
 Input Voltage (V): 120 - 277
 Constant Current (MA): 350

LED

Color Temperature (°K): 3000 / 4000
 Max. Delivered Lumen (lm): 285 / 300
 Nominal Lumen (lm): 350 / 380
 CRI: >80 CRI
 Lamp Life (hrs): 50000

OPTICAL

Optic°: 45

RATINGS AND CERTIFICATIONS

Certified By: Certified for North American Standards
 IP rating: IP67
 IK Rating: IK07



0.40 kg / 0.88 lbs

61mm (2 3/8")

Recessed Thickness: 10 / 12.5 / 15 / 25 / 30 mm
 (3/8" / 1/2" / 9/16" / 1" / 1 3/16")



OLODUM ROUND RECESSED

E10Q0034-

PROJECT	
TYPE	
SPECIFIER	
QUANTITY	
DATE	

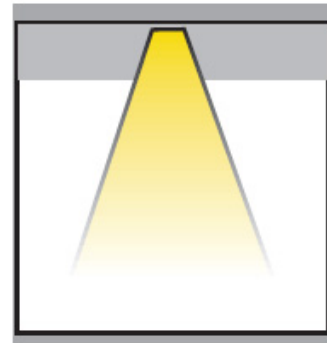

Emax/Emin	Beam Spread	Area	Height
	180°	Area: NAN x NAN	0 m
	90°	Area: NAN x NAN	2 m
		Area: NAN x NAN	4 m
		Area: NAN x NAN	6 m
		Area: NAN x NAN	8 m
		Area: NAN x NAN	10 m
		Area: NAN x NAN	12 m
	0°		
	C0-C180: 154° + 154°		
	C90-C270: 153° + 153°		

Additional data from the diagram:

- 78 / 22
- 20 / 8
- 9 / 4
- 5 / 3
- 4 / 2
- 3 / 2

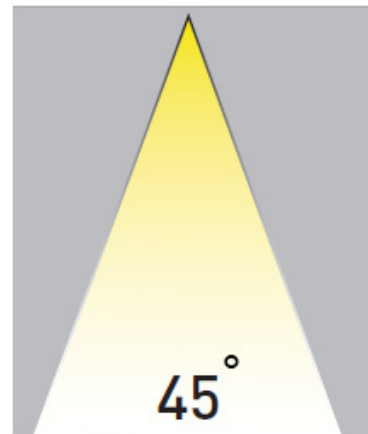

PROJECT	
TYPE	
SPECIFIER	
QUANTITY	
DATE	

OLODUM RECESSED

E10Q0040- -

base number Color BA Options
 Temperature

- To build a product code in our configurator select the specify button on the base model # product page
- To build a manual product code on this datasheet choose from the options listed below in blue font and add the suffix to the base model #

GENERAL

Series: Olodum
 Brand: Side
 Division: Exterior
 Mounting Type: Recessed
 Mounting Location: Ceiling
 Subcategory: Downlight

PHYSICAL

Shape: Round
 Diameter (mm): 220
 Diameter (in): 8 11/16
 Height (mm): 215
 Height (in): 8 7/16
 Light Distribution: Adjustable / Direct
 Weight (kg): 3.6
 Weight (lbs): 7.94
 Diffuser: Clear tempered glass
 Fixture Finish: SSS
 Fixture Material: Aluminum Die Cast

ELECTRICAL

Lamp Type: LED (Zhaga Standard)
 Input Wattage (W): 20
 Total Output Wattage (W): 17
 Dimming: Tri-Mode (Non-Dimming and Phase Dimming (120Vac only) and 0-10V Dimming)
 Driver Included: Yes
 Driver Location: Integrated
 Driver Type: Constant Current - Universal
 Driver Class: Class 2
 Input Voltage (V): 120 - 277
 Constant Current (MA): 500
 Upon Request: (Not included - see components [IP65 or higher enclosure to be supplied by others]) 0-10Vdc dimming / (Included) Integral: Phase dimming @120Vac only / 277Vac

LED

Color Temperature (°K): 3000 / 4000
 Max. Delivered Lumen (lm): 2434.9 / 2607.5
 Nominal Lumen (lm): 2750 / 2945
 CRI: >80 CRI
 Lamp Life (hrs): 50000

OPTICAL

Reflector: Polycarbonate metallized reflector
 Optic: 15 / 45 / 65 / ASY

RATINGS AND CERTIFICATIONS

Certified By: Certified for North American Standards
 IP rating: IP67
 IK Rating: IK10

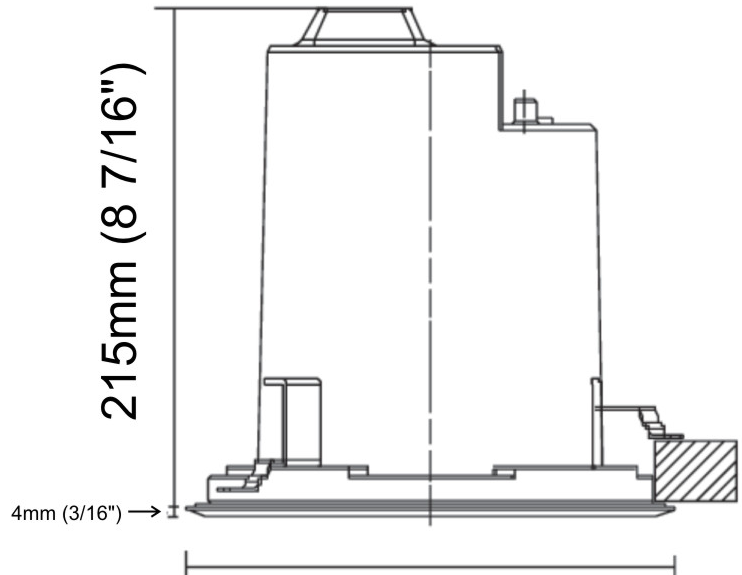

220mm (8 11/16")

Recessed Thickness 10 / 12.5 / 15 / 25 / 30 mm
 (3/8" / 1/2" / 9/16" / 1" / 1 3/16")



201mm (7 15/16")
 3.6kg / 7.93lbs

PROJECT	
TYPE	
SPECIFIER	
QUANTITY	
DATE	

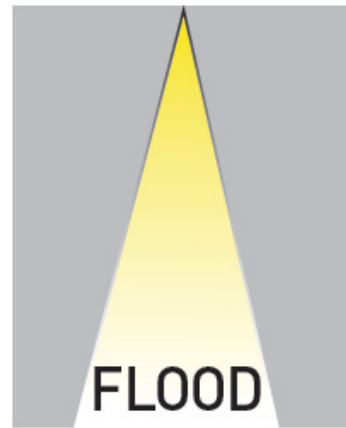

PROJECT	
TYPE	
SPECIFIER	
QUANTITY	
DATE	

OLODUM RECESSED

E10Q0046- -

base number Color BA Options
 Temperature

- To build a product code in our configurator select the specify button on the base model # product page
- To build a manual product code on this datasheet choose from the options listed below in blue font and add the suffix to the base model #

GENERAL

Series: Olodum
 Brand: Side
 Division: Exterior
 Mounting Type: Recessed
 Mounting Location: Ceiling
 Subcategory: Downlight

PHYSICAL

Shape: Round
 Diameter (mm): 220
 Diameter (in): 8 11/16
 Height (mm): 215
 Height (in): 8 7/16
 Light Distribution: Adjustable / Direct
 Weight (kg): 3.6
 Weight (lbs): 7.94
 Diffuser: Clear tempered glass
 Fixture Finish: SSS
 Fixture Material: Aluminum Die Cast

ELECTRICAL

Lamp Type: LED (Zhaga Standard)
 Input Wattage (W): 20
 Total Output Wattage (W): 17
 Dimming: Tri-Mode (Non-Dimming and Phase Dimming (120Vac only) and 0-10V Dimming)
 Driver Included: Yes
 Driver Location: Integrated
 Driver Type: Constant Current - Universal
 Driver Class: Class 2
 Input Voltage (V): 120 - 277
 Constant Current (MA): 500
 Upon Request: (Not included - see components [IP65 or higher enclosure to be supplied by others]) 0-10Vdc dimming / (Included) Integral: Phase dimming @120Vac only / 277Vac

LED

Color Temperature (°K): 3000 / 4000
 Max. Delivered Lumen (lm): 2434.9 / 2587.5
 Nominal Lumen (lm): 2750 / 2945
 CRI: >80 CRI
 Lamp Life (hrs): 50000

OPTICAL

Reflector: Polycarbonate metallized reflector
 Beam Angle: Spot - 15° / Flood - 45° / Wide Flood - 65° / Asymmetric

RATINGS AND CERTIFICATIONS

Certified By: Certified for North American Standards
 IP rating: IP67
 IK Rating: IK10

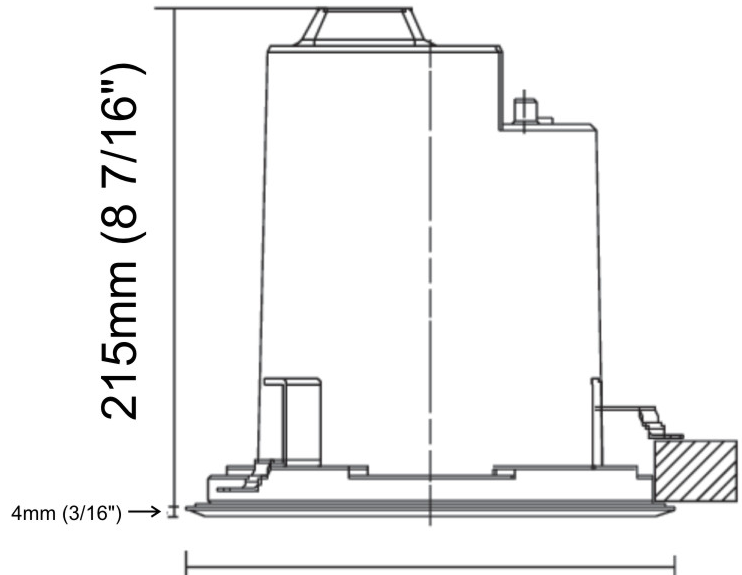

220mm (8 11/16")

Recessed Thickness 10 / 12.5 / 15 / 25 / 30 mm
 (3/8" / 1/2" / 9/16" / 1" / 1 3/16")



201mm (7 15/16")
 3.6kg / 7.93lbs

PROJECT	
TYPE	
SPECIFIER	
QUANTITY	
DATE	

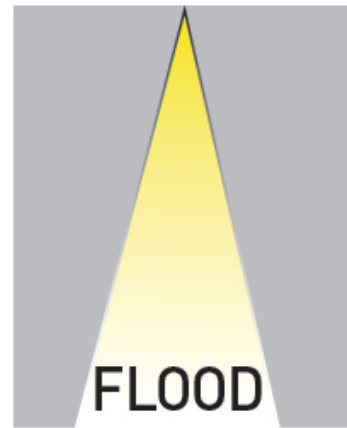

PROJECT	_____
TYPE	_____
SPECIFIER	_____
QUANTITY	_____
DATE	_____

OLODUM ROUND RECESSED

E10Q0052- _____ - _____

base number Color BA Options
 Temperature

- To build a product code in our configurator select the specify button on the base model # product page
- To build a manual product code on this datasheet choose from the options listed below in blue font and add the suffix to the base model #

GENERAL

Series: Olodum
 Subseries: Olodum Round
 Brand: Side
 Division: Exterior
 Mounting Type: Recessed
 Mounting Location: Ceiling
 Subcategory: Downlight

PHYSICAL

Shape: Round
 Diameter (mm): 130
 Diameter (in): 5 1/8
 Height (mm): 132
 Height (in): 5 3/16
 Light Distribution: Downlight
 Weight (kg): 1.450
 Weight (lbs): 3.2
 Diffuser: Clear tempered glass
 Gasket: Silicon rubber
 Fixture Finish: SSS
 Fixture Material: Aluminum Die Cast

ELECTRICAL

Lamp Type: LED (Zhaga Standard)
 Input Wattage (W): 6.8
 Total Output Wattage (W): 5.8
 Dimming: 0-10V Dimming / Phase Dimming (120Vac Only)
 Driver Included: No
 Driver Location: Remote
 Driver Type: Constant Current - Universal
 Driver Class: Class 2
 Input Voltage (V): 120 - 277
 Constant Current (MA): 203
 Upon Request: (Not included - see components [IP65 or higher enclosure to be supplied by others]) 0-10Vdc dimming / Phase dimming @120Vac only / 277Vac

LED

Color Temperature (°K): 3000 / 4000
 Max. Delivered Lumen (lm): 814.5 / 868.5
 CRI: >80 CRI
 Lamp Life (hrs): 50000

OPTICAL

Reflector: Polycarbonate metallized reflector
 Optic: 15 / 30 / 45

RATINGS AND CERTIFICATIONS

Certified By: Certified for North American Standards
 IP rating: IP67
 IK Rating: IK10



1.45kg / 3.2lbs

Recessed Thickness 10 / 12.5 / 15 mm (3/8" / 1/2" / 9/16")

127mm (5")



OLODUM ROUND RECESSED

E10Q0052-

PROJECT	
TYPE	
SPECIFIER	
QUANTITY	
DATE	



E

OLODUM RECESSED

E10Q0058- -

base number Color Lens
 Temperature Options

PROJECT
TYPE
SPECIFIER
QUANTITY
DATE

- To build a product code in our configurator select the specify button on the base model # product page
- To build a manual product code on this datasheet choose from the options listed below in blue font and add the suffix to the base model #

GENERAL

Series: Olodum
 Brand: Side
 Division: Exterior
 Mounting Type: Recessed
 Mounting Location: Ceiling

PHYSICAL

Shape: Round
 Diameter (mm): 180
 Diameter (in): 7 1/16
 Height (mm): 250
 Height (in): 9 13/16
 Light Distribution: Direct
 Weight (kg): 3.4
 Weight (lbs): 7.5
 Diffuser: Clear Tempered Glass
 Fixture Finish: SSS
 Fixture Material: Aluminum Die Cast

ELECTRICAL

Lamp Type: LED (Zhaga Standard)
 Input Wattage (W): 9.1

LED

Number of LEDs: 1
 Color Temperature (°K): 3000 / 4000
 Max. Delivered Lumen (lm): 1157 / 1239
 Nominal Lumen (lm): 1410 / 1510
 CRI: >90 CRI

OPTICAL

Reflector: Polycarbonate metallized reflector
 Optic: 15° / 30° / 45°

RATINGS AND CERTIFICATIONS

Certified By: CSA Certified to UL and CSA Standards
 IP rating: IP67
 IK Rating: IK10

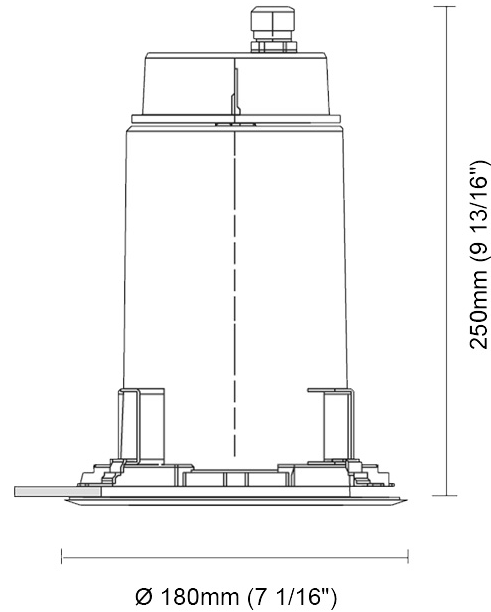

 3.4kg / 7.49lbs
 180mm (7 1/16")
 10 / 12.5 / 15 mm (3/8" / 1/2" / 9/16")



PROJECT
TYPE
SPECIFIER
QUANTITY
DATE

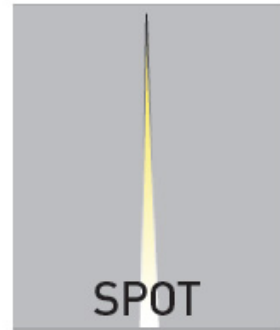
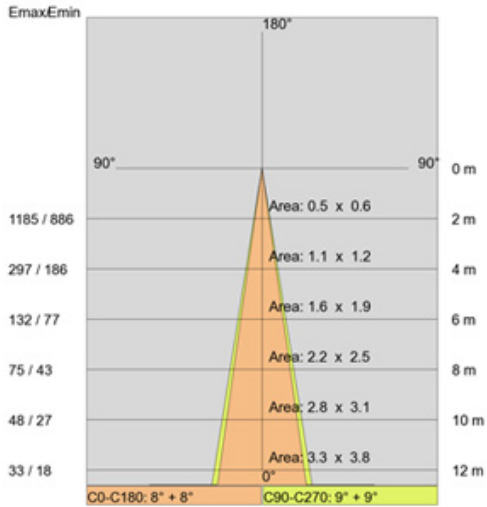
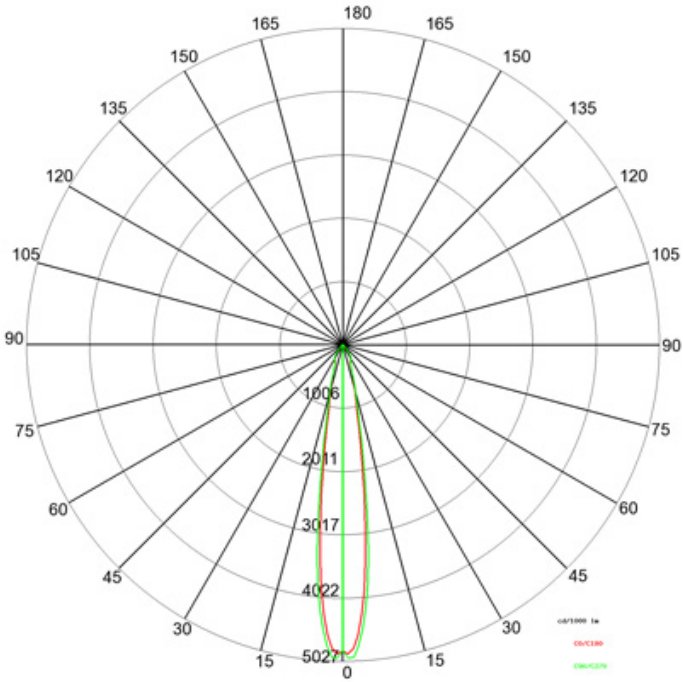

PROJECT

TYPE

SPECIFIER

QUANTITY

DATE

Fixture Finish

Satined Stainless Steel - SSS



Digital: Not all screens are calibrated the same, and therefore, colors will appear differently between screens.

Physical: When texture is involved, there will be variations in color, character and tone within a product series and between product families.



PROJECT	
TYPE	
SPECIFIER	
QUANTITY	
DATE	

LEGEND

floor-mounted	pivotal	special LED (upon request) RGB, RGBW, tunable, gold+, meat+, art+, fashion+
wall and ceiling: recessed and surface mounted	rotating	warm dim / natural dimming LED
ceiling-mounted and wall-mounted	illuminate tilted	rechargeable battery powered
wall-mounted	color of suspension cable	fixture with natural vivid LED (upon request)
omni-directional light distribution	length of suspension cable	color rendering index
direct light distribution	reflector degree selection	color temperature
direct/indirect light distribution	super spot	lumen (luminous flux)
indirect light distribution	lens	efficacy (lumens per watt)
asymmetric light distribution	lens pack	Unified Glare Rating (UGR) range from 5-40
aura light distribution	shine ring	marine grade (AISI 316 stainless steel)
round wall or ceiling cut-out	integrated shine ring with diffuser	walk on
square wall or ceiling cut-out	free individual colors 01-29	drive on
the supplied jig specifies the cutout dimensions	individual colors: 00 (free of charge), 01-25 (extra charge)	Dark Sky Compliance
minimum distance (meters) lamp - object	luminaire part to be colored (F1)	Americans with Disabilities Act (less than 4" off the wall located between 27"-84" from floor)
recessed depth	luminaire part to be colored (F2)	lamp protected against explosion
ceiling thickness in mm	luminaire part to be colored (F3)	blown glass using traditional methods by master glass blower
ceiling thickness selection	luminaire part to be colored (F4)	acoustic material
dimmable DP (phase), DV (0-10V), DD (dali), DS (step-dim)	luminaire part to be colored (F5)	protection class I, protection insulation
included or excluded LED driver/transformer/control gear	color of 3-circuit adaptor	protection class II, protection insulation
separately switchable	indirect diffuser	ETL Certified to UL and CSA Standards
sensor	direct diffuser	UL Certified to UL and CSA Standards
remote control	ball-proof (upon request)	CSA Certified to UL and CSA Standards
available upon request	accessory	Certified for North American Standards

IP RATING

IP20	protected against ingress of solid bodies greater than 12.5mm (finger)
IP33	protected against ingress of solid bodies greater than 2.5mm protected against sprays of water up to 60 degrees from the vertical (rain)
IP40	protected against ingress of solid bodies greater than 1mm (wire) no protection against the ingress of moisture
IP43	protected against ingress of solid bodies greater than 1mm (wire) protected against sprays of water up to 60 degrees from the vertical (rain)
IP44	protected against ingress of solid bodies greater than 1mm (wire) protected against water splashed from all directions
IP54	protected against limited ingress of dust (wet rooms/covered outdoor areas) protected against water splashed from all directions
IP65	protected against ingress of dust protected against jets of water
IP66	protected against ingress of dust protected against powerful jets of water or heavy seas
IP67	protected against ingress of dust protected against immersion of water between 15cm - 1m for 30 minutes
IP68	protected against ingress of dust protected against immersion of water under pressure for long periods

IK RATING

IK01	protected against 0.14 joules impact (equivalent to 0.25kg mass dropped from 56mm above the surface)
IK02	protected against 0.2 joules impact (equivalent to 0.25kg mass dropped from 80mm above the surface)
IK03	protected against 0.35 joules impact (equivalent to 0.25kg mass dropped from 140mm above the surface)
IK04	protected against 0.5 joules impact (equivalent to 0.25kg mass dropped from 200mm above the surface)
IK05	protected against 0.7 joules impact (equivalent to 0.25kg mass dropped from 280mm above the surface)
IK06	protected against 1 joules impact (equivalent to 0.25kg mass dropped from 400mm above the surface)
IK07	protected against 2 joules impact (equivalent to 0.5kg mass dropped from 400mm above the surface)
IK08	protected against 5 joules impact (equivalent to 1.7kg mass dropped from 300mm above the surface)
IK09	protected against 10 joules impact (equivalent to 5.0kg mass dropped from 200mm above the surface)
IK10	protected against 20 joules impact (equivalent to 5.0kg mass dropped from 400mm above the surface)