

OLODUM ROUND RECESSED

E10I0019-

base number _____ Color _____
 Temperature _____

- To build a product code in our configurator select the specify button on the base model # product page
- To build a manual product code on this datasheet choose from the options listed below in blue font and add the suffix to the base model #

GENERAL

Series: Olodum
 Subseries: Olodum Round
 Brand: Side
 Division: Exterior
 Mounting Type: Recessed
 Mounting Location: In-Ground
 Subcategory: Uplight

PHYSICAL

Shape: Round
 Diameter (mm): 76
 Diameter (in): 3
 Height (mm): 62
 Height (in): 2 7/16
 Light Distribution: Uplight
 Weight (kg): 0.3
 Weight (lbs): 0.66
 Diffuser: Clear tempered glass
 Gasket: Silicon rubber
 Fixture Finish: SSS
 Fixture Material: Stainless Steel

ELECTRICAL

Lamp Type: LED (Zhaga Standard)
 Total Output Wattage (W): 3.5
 Dimming: Non-Dimming / Phase Dimming (120Vac only) / 0-10V Dimming
 Driver Included: No
 Driver Location: Remote
 Driver Type: Constant Current - 120 / 277Vac
 Driver Class: Class 2
 Input Voltage (V): 120 - 277
 Constant Current (MA): 350
 Upon Request: Dimming requires 2 fixture minimum

LED

Color Temperature (°K): 3000 / 4000
 Max. Delivered Lumen (lm): 285 / 300
 CRI: >80 CRI
 Lamp Life (hrs): 50000

OPTICAL

Reflector: Polycarbonate Metallized Reflector
 Optic: 45

RATINGS AND CERTIFICATIONS

Certified By: Certified for North American Standards
 IP rating: IP67
 IK Rating: IK07



 0.30 kg / 0.66 lbs



OLODUM ROUND RECESSED

E10I0019-

PROJECT _____
 TYPE _____
 SPECIFIER _____
 QUANTITY _____
 DATE _____



Emax/Emin	180°	
	90°	0 m
		2 m
78 / 22		4 m
20 / 8		6 m
9 / 4		8 m
5 / 3		10 m
4 / 2		12 m
3 / 2	0°	
CO-C180: 154° + 154°		C90-C270: 153° + 153°

E

PROJECT	
TYPE	
SPECIFIER	
QUANTITY	
DATE	

OLODUM ROUND RECESSED

E10I0093-

base number Color
Temperature

- To build a product code in our configurator select the specify button on the base model # product page
- To build a manual product code on this datasheet choose from the options listed below in blue font and add the suffix to the base model #

GENERAL

Series: Olodum
 Subseries: Olodum Round
 Brand: Side
 Division: Exterior
 Mounting Type: Recessed
 Mounting Location: In-Ground
 Subcategory: Walk Over

PHYSICAL

Shape: Round
 Diameter (mm): 65
 Diameter (in): 2 9/16
 Height (mm): 62
 Height (in): 2 7/16
 Light Distribution: Uplight
 Weight (kg): 0.3
 Weight (lbs): 0.66
 Load Resistance (kg): 500
 Load Resistance (lbs): 1102
 Diffuser: Clear tempered glass
 Gasket: Silicon rubber
 Fixture Finish: SSS
 Fixture Material: Stainless Steel

ELECTRICAL

Lamp Type: LED (Zhaga Standard)
 Input Wattage (W): 3.5
 Total Output Wattage (W): 3
 Driver Included: No
 Input Voltage (V): 120
 Constant Current (MA): 350

LED

Number of LEDs: 1
 Color Temperature (°K): 3000 / 4000
 Max. Delivered Lumen (lm): 285 / 300
 CRI: >80 CRI

OPTICAL

Reflector: Polycarbonate metallized reflector
 Optic: 45

RATINGS AND CERTIFICATIONS

Certified By: Certified for North American Standards
 IP rating: IP67
 IK Rating: IK07



△ 0.3kg / 0.66lbs



OLODUM ROUND RECESSED

E10I0093-

PROJECT	
TYPE	
SPECIFIER	
QUANTITY	
DATE	



Emax/Emin	180°	
	90°	90° 0 m
78 / 22	Area: NAN x NAN	2 m
20 / 8	Area: NAN x NAN	4 m
9 / 4	Area: NAN x NAN	6 m
5 / 3	Area: NAN x NAN	8 m
4 / 2	Area: NAN x NAN	10 m
3 / 2	Area: NAN x NAN	12 m
	0°	
	C0-C180: 154° + 154°	C90-C270: 153° + 153°



OLODUM SQUARE RECESSED

E10I0094-

base number _____ Color _____
 Temperature _____

- To build a product code in our configurator select the specify button on the base model # product page
- To build a manual product code on this datasheet choose from the options listed below in blue font and add the suffix to the base model #

GENERAL

Series: Olodum
 Subseries: Olodum Square
 Brand: Side
 Division: Exterior
 Mounting Type: Recessed
 Mounting Location: In-Ground
 Subcategory: Walk Over

PHYSICAL

Shape: Square
 Width (mm): 76
 Width (in): 3
 Height (mm): 62
 Height (in): 2 7/16
 Light Distribution: Uplight
 Weight (kg): 0.3
 Weight (lbs): 0.66
 Load Resistance (kg): 500
 Load Resistance (lbs): 1102
 Diffuser: Clear tempered glass
 Gasket: Silicon rubber
 Fixture Finish: SSS
 Fixture Material: Stainless Steel

ELECTRICAL

Lamp Type: LED (Zhaga Standard)
 Input Wattage (W): 3.5
 Total Output Wattage (W): 3.5
 Driver Included: No
 Input Voltage (V): 120
 Constant Current (MA): 350

LED

Number of LEDs: 1
 Color Temperature (°K): 3000 / 4000
 Max. Delivered Lumen (lm): 285 / 300
 CRI: >80 CRI

OPTICAL

Reflector: Polycarbonate metallized reflector
 Optic: 45

RATINGS AND CERTIFICATIONS

Certified By: Certified for North American Standards
 IP rating: IP67
 IK Rating: IK07



4mm (3/16")

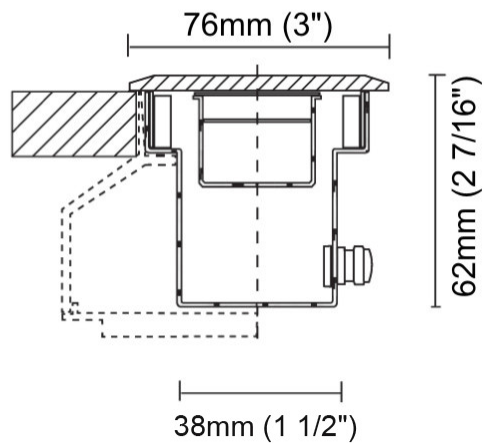
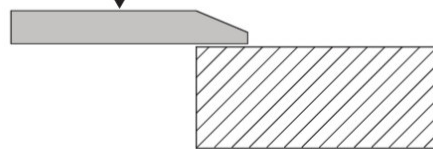

0.30 kg / 0.66 lbs



PROJECT

TYPE

SPECIFIER

QUANTITY

DATE

Fixture Finish

Satined Stainless Steel - SSS



Digital: Not all screens are calibrated the same, and therefore, colors will appear differently between screens.











Physical: When texture is involved, there will be variations in color, character and tone within a product series and between product families.













LEGEND

	floor-mounted		pivotal		special LED (upon request) RGB, RGBW, tunable, gold+, meat+, art+, fashion+
	wall and ceiling: recessed and surface mounted		rotating		warm dim / natural dimming LED
	ceiling-mounted and wall-mounted		illuminate tilted		rechargeable battery powered
	wall-mounted		color of suspension cable		fixture with natural vivid LED (upon request)
	omni-directional light distribution		length of suspension cable		color rendering index
	direct light distribution		reflector degree selection		color temperature
	direct/indirect light distribution		super spot		lumen (luminous flux)
	indirect light distribution		lens		efficacy (lumens per watt)
	asymmetric light distribution		lens pack		Unified Glare Rating (UGR) range from 5-40
	aura light distribution		shine ring		marine grade (AISI 316 stainless steel)
	round wall or ceiling cut-out		integrated shine ring with diffuser		walk on
	square wall or ceiling cut-out		free individual colors 01-29		drive on
	the supplied jig specifies the cutout dimensions		individual colors: 00 (free of charge), 01-25 (extra charge)		Dark Sky Compliance
	minimum distance (meters) lamp - object		luminaire part to be colored (F1)		Americans with Disabilities Act (less than 4" off the wall located between 27"-84" from floor)
	recessed depth		luminaire part to be colored (F2)		lamp protected against explosion
	ceiling thickness in mm		luminaire part to be colored (F3)		blown glass using traditional methods by master glass blower
	ceiling thickness selection		luminaire part to be colored (F4)		acoustic material
	dimmable DP (phase), DV (0-10V), DD (dali), DS (step-dim)		luminaire part to be colored (F5)		protection class I, protection insulation
	included or excluded LED driver/transformer/control gear		color of 3-circuit adaptor		protection class II, protection insulation
	separately switchable		indirect diffuser		ETL Certified to UL and CSA Standards
	sensor		direct diffuser		UL Certified to UL and CSA Standards
	remote control		ball-proof (upon request)		CSA Certified to UL and CSA Standards
	available upon request		accessory		Certified for North American Standards

IP RATING

	protected against ingress of solid bodies greater than 12.5mm (finger)
	protected against ingress of solid bodies greater than 2.5mm protected against sprays of water up to 60 degrees from the vertical (rain)
	protected against ingress of solid bodies greater than 1mm (wire) no protection against the ingress of moisture
	protected against ingress of solid bodies greater than 1mm (wire) protected against sprays of water up to 60 degrees from the vertical (rain)
	protected against ingress of solid bodies greater than 1mm (wire) protected against water splashed from all directions
	protected against limited ingress of dust (wet rooms/covered outdoor areas) protected against water splashed from all directions
	protected against ingress of dust protected against jets of water
	protected against ingress of dust protected against powerful jets of water or heavy seas
	protected against ingress of dust protected against immersion of water between 15cm - 1m for 30 minutes
	protected against ingress of dust protected against immersion of water under pressure for long periods

IK RATING

	protected against 0.14 joules impact (equivalent to 0.25kg mass dropped from 56mm above the surface)
	protected against 0.2 joules impact (equivalent to 0.25kg mass dropped from 80mm above the surface)
	protected against 0.35 joules impact (equivalent to 0.25kg mass dropped from 140mm above the surface)
	protected against 0.5 joules impact (equivalent to 0.25kg mass dropped from 200mm above the surface)
	protected against 0.7 joules impact (equivalent to 0.25kg mass dropped from 280mm above the surface)
	protected against 1 joules impact (equivalent to 0.25kg mass dropped from 400mm above the surface)
	protected against 2 joules impact (equivalent to 0.5kg mass dropped from 400mm above the surface)
	protected against 5 joules impact (equivalent to 1.7kg mass dropped from 300mm above the surface)
	protected against 10 joules impact (equivalent to 5.0kg mass dropped from 200mm above the surface)
	protected against 20 joules impact (equivalent to 5.0kg mass dropped from 400mm above the surface)