

## OLODUM ROUND RECESSED

### E10I0019-

base number \_\_\_\_\_ Color \_\_\_\_\_  
 Temperature \_\_\_\_\_

- To build a product code in our configurator select the specify button on the base model # product page
- To build a manual product code on this datasheet choose from the options listed below in blue font and add the suffix to the base model #

#### GENERAL

Series: Olodum  
 Subseries: Olodum Round  
 Brand: Side  
 Division: Exterior  
 Mounting Type: Recessed  
 Mounting Location: In-Ground  
 Subcategory: Uplight

#### PHYSICAL

Shape: Round  
 Diameter (mm): 76  
 Diameter (in): 3  
 Height (mm): 62  
 Height (in): 2 7/16  
 Light Distribution: Uplight  
 Weight (kg): 0.3  
 Weight (lbs): 0.66  
 Diffuser: Clear tempered glass  
 Gasket: Silicon rubber  
 Fixture Finish: SSS  
 Fixture Material: Stainless Steel

#### ELECTRICAL

Lamp Type: LED (Zhaga Standard)  
 Total Output Wattage (W): 3.5  
 Dimming: Non-Dimming / Phase Dimming (120Vac only) / 0-10V Dimming  
 Driver Included: No  
 Driver Location: Remote  
 Driver Type: Constant Current - 120 / 277Vac  
 Driver Class: Class 2  
 Input Voltage (V): 120 - 277  
 Constant Current (MA): 350  
 Upon Request: Dimming requires 2 fixture minimum

#### LED

Color Temperature (°K): 3000 / 4000  
 Max. Delivered Lumen (lm): 285 / 300  
 CRI: >80 CRI  
 Lamp Life (hrs): 50000

#### OPTICAL

Reflector: Polycarbonate Metallized Reflector  
 Optic: 45

#### RATINGS AND CERTIFICATIONS

Certified By: Certified for North American Standards  
 IP rating: IP67  
 IK Rating: IK07



0.30 kg / 0.66 lbs



## OLODUM ROUND RECESSED

E10I0019-

PROJECT \_\_\_\_\_  
 TYPE \_\_\_\_\_  
 SPECIFIER \_\_\_\_\_  
 QUANTITY \_\_\_\_\_  
 DATE \_\_\_\_\_

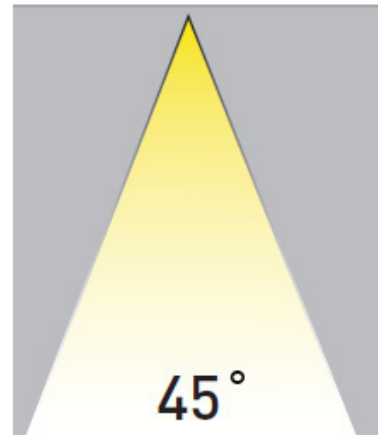
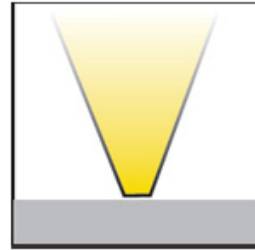
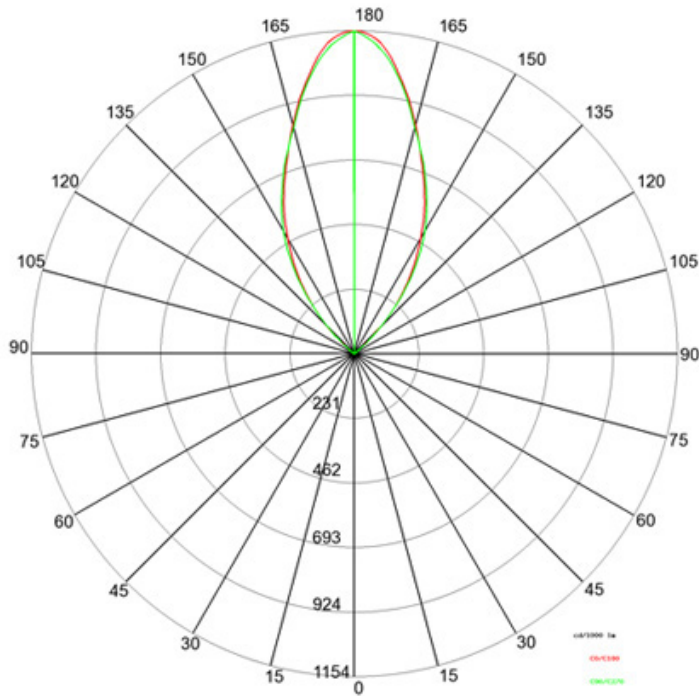

Emax/Emin	180°	
	90°	0 m
		2 m
		4 m
		6 m
		8 m
		10 m
		12 m
	0°	
78 / 22		Area: NAN x NAN
20 / 8		Area: NAN x NAN
9 / 4		Area: NAN x NAN
5 / 3		Area: NAN x NAN
4 / 2		Area: NAN x NAN
3 / 2		Area: NAN x NAN
	00-C180: 154° + 154°	C90-C270: 153° + 153°

E

PROJECT	
TYPE	
SPECIFIER	
QUANTITY	
DATE	

## OLODUM ROUND RECESSED

### E10I0093-

base number Color  
Temperature

- To build a product code in our configurator select the specify button on the base model # product page
- To build a manual product code on this datasheet choose from the options listed below in blue font and add the suffix to the base model #

#### GENERAL

Series: Olodum  
 Subseries: Olodum Round  
 Brand: Side  
 Division: Exterior  
 Mounting Type: Recessed  
 Mounting Location: In-Ground  
 Subcategory: Walk Over

#### PHYSICAL

Shape: Round  
 Diameter (mm): 65  
 Diameter (in): 2 9/16  
 Height (mm): 62  
 Height (in): 2 7/16  
 Light Distribution: Uplight  
 Weight (kg): 0.3  
 Weight (lbs): 0.66  
 Load Resistance (kg): 500  
 Load Resistance (lbs): 1102  
 Diffuser: Clear tempered glass  
 Gasket: Silicon rubber  
 Fixture Finish: SSS  
 Fixture Material: Stainless Steel

#### ELECTRICAL

Lamp Type: LED (Zhaga Standard)  
 Input Wattage (W): 3.5  
 Total Output Wattage (W): 3  
 Driver Included: No  
 Input Voltage (V): 120  
 Constant Current (MA): 350

#### LED

Number of LEDs: 1  
 Color Temperature (°K): 3000 / 4000  
 Max. Delivered Lumen (lm): 285 / 300  
 CRI: >80 CRI

#### OPTICAL

Reflector: Polycarbonate metallized reflector  
 Optic: 45

#### RATINGS AND CERTIFICATIONS

Certified By: Certified for North American Standards  
 IP rating: IP67  
 IK Rating: IK07

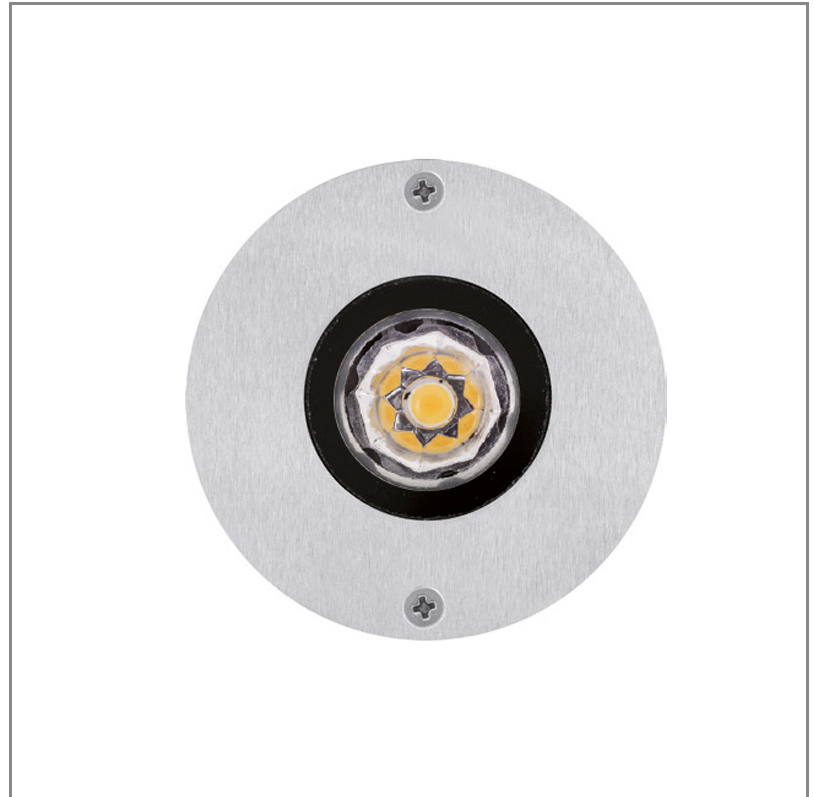

0.3kg / 0.66lbs



## OLODUM ROUND RECESSED

E10I0093-

PROJECT	
TYPE	
SPECIFIER	
QUANTITY	
DATE	

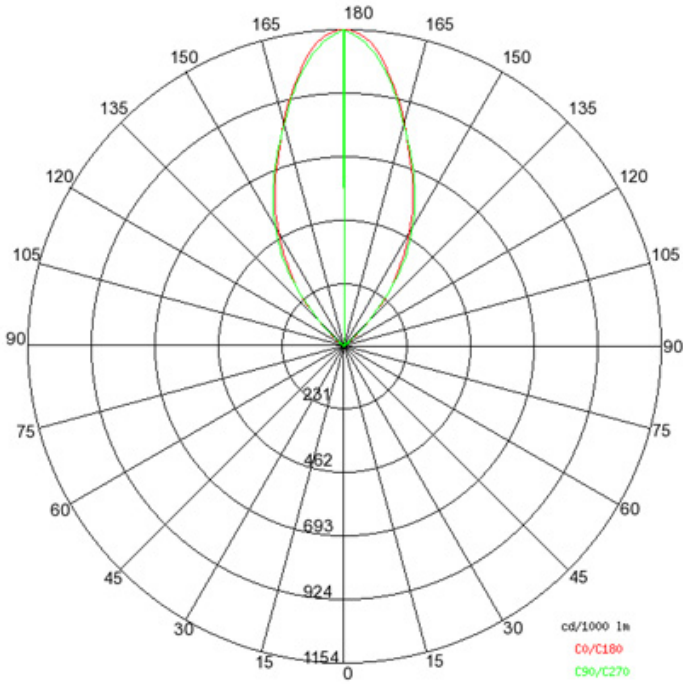

Emax/Emin	180°	
	90°	90° 0 m
78 / 22		Area: NAN x NAN 2 m
20 / 8		Area: NAN x NAN 4 m
9 / 4		Area: NAN x NAN 6 m
5 / 3		Area: NAN x NAN 8 m
4 / 2		Area: NAN x NAN 10 m
3 / 2		Area: NAN x NAN 12 m
	0°	
	C0-C180: 154° + 154°	C90-C270: 153° + 153°



## OLODUM SQUARE RECESSED

### E10I0094-

base number \_\_\_\_\_ Color \_\_\_\_\_  
 Temperature \_\_\_\_\_

- To build a product code in our configurator select the specify button on the base model # product page
- To build a manual product code on this datasheet choose from the options listed below in blue font and add the suffix to the base model #

#### GENERAL

Series: Olodum  
 Subseries: Olodum Square  
 Brand: Side  
 Division: Exterior  
 Mounting Type: Recessed  
 Mounting Location: In-Ground  
 Subcategory: Walk Over

#### PHYSICAL

Shape: Square  
 Width (mm): 76  
 Width (in): 3  
 Height (mm): 62  
 Height (in): 2 <sup>7</sup>/<sub>16</sub>  
 Light Distribution: Uplight  
 Weight (kg): 0.3  
 Weight (lbs): 0.66  
 Load Resistance (kg): 500  
 Load Resistance (lbs): 1102  
 Diffuser: Clear tempered glass  
 Gasket: Silicon rubber  
 Fixture Finish: SSS  
 Fixture Material: Stainless Steel

#### ELECTRICAL

Lamp Type: LED (Zhaga Standard)  
 Input Wattage (W): 3.5  
 Total Output Wattage (W): 3.5  
 Driver Included: No  
 Input Voltage (V): 120  
 Constant Current (MA): 350

#### LED

Number of LEDs: 1  
 Color Temperature (°K): 3000 / 4000  
 Max. Delivered Lumen (lm): 285 / 300  
 CRI: >80 CRI

#### OPTICAL

Reflector°: Polycarbonate metallized reflector  
 Optic°: 45

#### RATINGS AND CERTIFICATIONS

Certified By: Certified for North American Standards  
 IP rating: IP67  
 IK Rating: IK07



4mm (3/16")

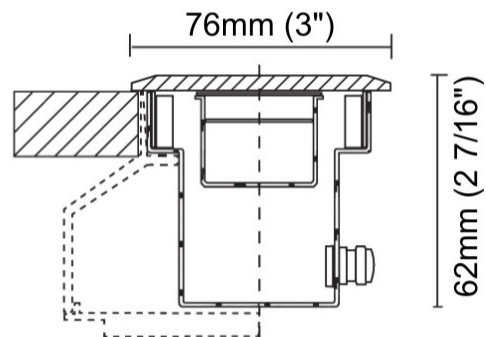
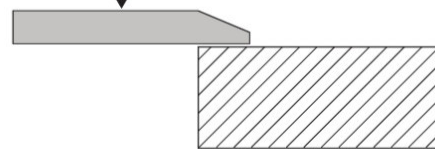

38mm (1 1/2")

0.30 kg / 0.66 lbs



## OLODUM SQUARE RECESSED

E10I0094-

PROJECT \_\_\_\_\_  
 TYPE \_\_\_\_\_  
 SPECIFIER \_\_\_\_\_  
 QUANTITY \_\_\_\_\_  
 DATE \_\_\_\_\_

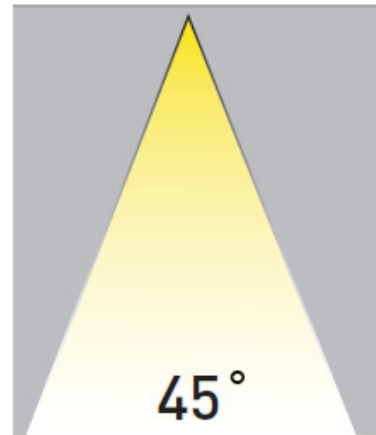
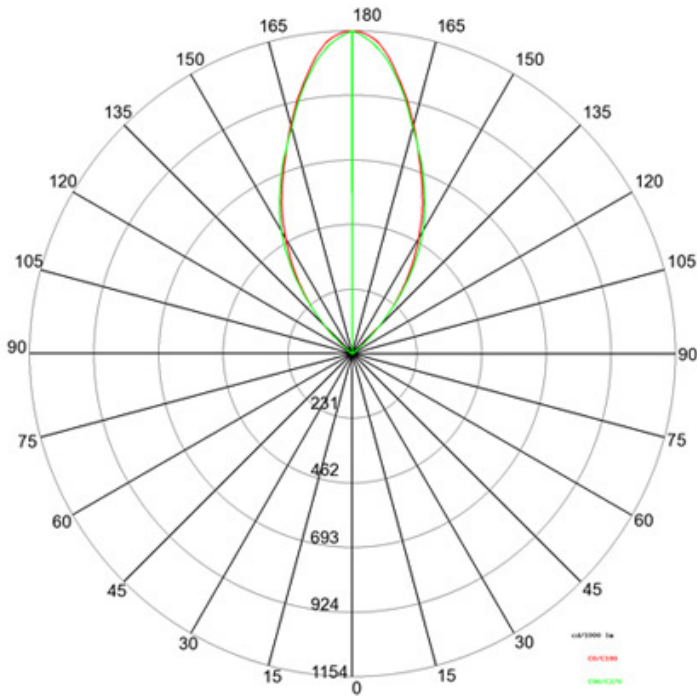

Emax/Emin	180°	
	90°	0 m
		2 m
		4 m
		6 m
		8 m
		10 m
		12 m
	0°	
78 / 22		Area: NAN x NAN
20 / 8		Area: NAN x NAN
9 / 4		Area: NAN x NAN
5 / 3		Area: NAN x NAN
4 / 2		Area: NAN x NAN
3 / 2		Area: NAN x NAN
	CO-C180: 154° + 154°	C90-C270: 153° + 153°

E

PROJECT

TYPE

SPECIFIER

QUANTITY

DATE

#### Fixture Finish

Satined Stainless Steel - SSS



**Digital:** Not all screens are calibrated the same, and therefore, colors will appear differently between screens.

**Physical:** When texture is involved, there will be variations in color, character and tone within a product series and between product families.



PROJECT	
TYPE	
SPECIFIER	
QUANTITY	
DATE	

### LEGEND

floor-mounted	pivotable	special LED (upon request) RGB, RGBW, tunable, gold+, meat+, art+, fashion+
wall and ceiling: recessed and surface mounted	rotating	warm dim / natural dimming LED
ceiling-mounted and wall-mounted	illuminate tilted	rechargeable battery powered
wall-mounted	color of suspension cable	fixture with natural vivid LED (upon request)
omni-directional light distribution	length of suspension cable	color rendering index
direct light distribution	reflector degree selection	color temperature
direct/indirect light distribution	super spot	lumen (luminous flux)
indirect light distribution	lens	efficacy (lumens per watt)
asymmetric light distribution	lens pack	Unified Glare Rating (UGR) range from 5-40
aura light distribution	shine ring	marine grade (AISI 316 stainless steel)
round wall or ceiling cut-out	integrated shine ring with diffuser	walk on
square wall or ceiling cut-out	free individual colors 01-29	drive on
the supplied jig specifies the cutout dimensions	individual colors: 00 (free of charge), 01-25 (extra charge)	Dark Sky Compliance
minimum distance (meters) lamp - object	luminaire part to be colored (F1)	Americans with Disabilities Act (less than 4" off the wall located between 27"-84" from floor)
recessed depth	luminaire part to be colored (F2)	lamp protected against explosion
ceiling thickness in mm	luminaire part to be colored (F3)	blown glass using traditional methods by master glass blower
ceiling thickness selection	luminaire part to be colored (F4)	acoustic material
dimmable DP (phase), DV (0-10V), DD (dali), DS (step-dim)	luminaire part to be colored (F5)	protection class I, protection insulation
included or excluded LED driver/transformer/control gear	color of 3-circuit adaptor	protection class II, protection insulation
separately switchable	indirect diffuser	ETL Certified to UL and CSA Standards
sensor	direct diffuser	UL Certified to UL and CSA Standards
remote control	ball-proof (upon request)	CSA Certified to UL and CSA Standards
available upon request	accessory	Certified for North American Standards

### IP RATING

IP20	protected against ingress of solid bodies greater than 12.5mm (finger)
IP33	protected against ingress of solid bodies greater than 2.5mm protected against sprays of water up to 60 degrees from the vertical (rain)
IP40	protected against ingress of solid bodies greater than 1mm (wire) no protection against the ingress of moisture
IP43	protected against ingress of solid bodies greater than 1mm (wire) protected against sprays of water up to 60 degrees from the vertical (rain)
IP44	protected against ingress of solid bodies greater than 1mm (wire) protected against water splashed from all directions
IP54	protected against limited ingress of dust (wet rooms/covered outdoor areas) protected against water splashed from all directions
IP65	protected against ingress of dust protected against jets of water
IP66	protected against ingress of dust protected against powerful jets of water or heavy seas
IP67	protected against ingress of dust protected against immersion of water between 15cm - 1m for 30 minutes
IP68	protected against ingress of dust protected against immersion of water under pressure for long periods

### IK RATING

IK01	protected against 0.14 joules impact (equivalent to 0.25kg mass dropped from 56mm above the surface)
IK02	protected against 0.2 joules impact (equivalent to 0.25kg mass dropped from 80mm above the surface)
IK03	protected against 0.35 joules impact (equivalent to 0.25kg mass dropped from 140mm above the surface)
IK04	protected against 0.5 joules impact (equivalent to 0.25kg mass dropped from 200mm above the surface)
IK05	protected against 0.7 joules impact (equivalent to 0.25kg mass dropped from 280mm above the surface)
IK06	protected against 1 joules impact (equivalent to 0.25kg mass dropped from 400mm above the surface)
IK07	protected against 2 joules impact (equivalent to 0.5kg mass dropped from 400mm above the surface)
IK08	protected against 5 joules impact (equivalent to 1.7kg mass dropped from 300mm above the surface)
IK09	protected against 10 joules impact (equivalent to 5.0kg mass dropped from 200mm above the surface)
IK10	protected against 20 joules impact (equivalent to 5.0kg mass dropped from 400mm above the surface)