

OLODUM ROUND RECESSED

E10I0019-

base number _____ Color _____
 Temperature _____

- To build a product code in our configurator select the specify button on the base model # product page
- To build a manual product code on this datasheet choose from the options listed below in blue font and add the suffix to the base model #

GENERAL

Series: Olodum
 Subseries: Olodum Round
 Brand: Side
 Division: Exterior
 Mounting Type: Recessed
 Mounting Location: In-Ground
 Subcategory: Uplight

PHYSICAL

Shape: Round
 Diameter (mm): 76
 Diameter (in): 3
 Height (mm): 62
 Height (in): 2 7/16
 Light Distribution: Uplight
 Weight (kg): 0.3
 Weight (lbs): 0.66
 Diffuser: Clear tempered glass
 Gasket: Silicon rubber
 Fixture Finish: SSS
 Fixture Material: Stainless Steel

ELECTRICAL

Lamp Type: LED (Zhaga Standard)
 Total Output Wattage (W): 3.5
 Dimming: Non-Dimming / Phase Dimming (120Vac only) / 0-10V Dimming
 Driver Included: No
 Driver Location: Remote
 Driver Type: Constant Current - 120 / 277Vac
 Driver Class: Class 2
 Input Voltage (V): 120 - 277
 Constant Current (MA): 350
 Upon Request: Dimming requires 2 fixture minimum

LED

Color Temperature (°K): 3000 / 4000
 Max. Delivered Lumen (lm): 285 / 300
 CRI: >80 CRI
 Lamp Life (hrs): 50000

OPTICAL

Reflector: Polycarbonate Metallized Reflector
 Optic: 45

RATINGS AND CERTIFICATIONS

Certified By: Certified for North American Standards
 IP rating: IP67
 IK Rating: IK07



 0.30 kg / 0.66 lbs



OLODUM ROUND RECESSED

E10I0019-

PROJECT	
TYPE	
SPECIFIER	
QUANTITY	
DATE	

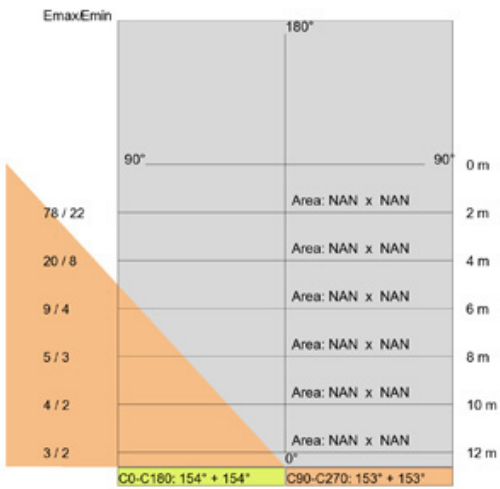
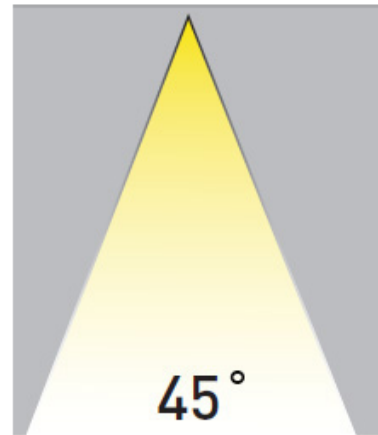
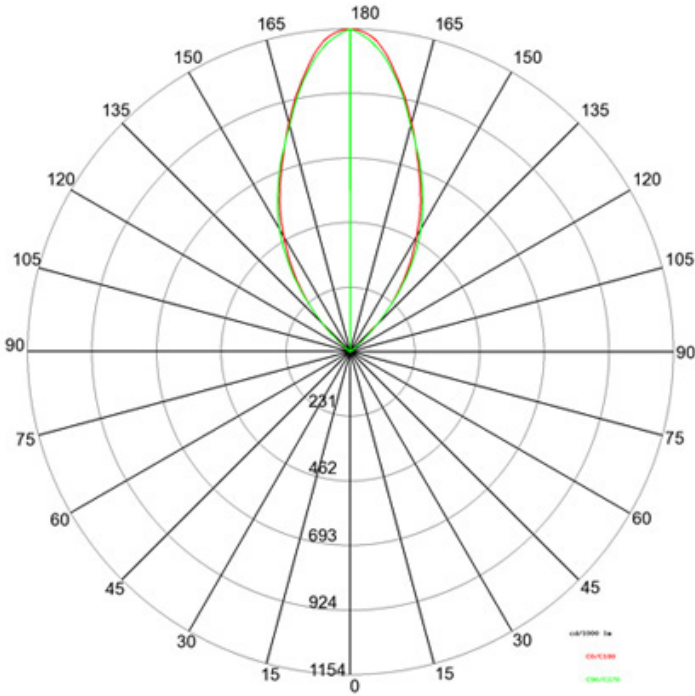

E

OLODUM RECESSED

E10I0047- -

base number Color BA Options
 Temperature

- To build a product code in our configurator select the specify button on the base model # product page
- To build a manual product code on this datasheet choose from the options listed below in blue font and add the suffix to the base model #

GENERAL

Series: Olodum
 Brand: Side
 Division: Exterior
 Mounting Type: Recessed
 Mounting Location: In-Ground
 Subcategory: Drive Over

PHYSICAL

Shape: Round
 Diameter (mm): 220
 Diameter (in): 8 ¹¹/₁₆
 Height (mm): 242
 Height (in): 9 ¹/₂
 Light Distribution: Adjustable / Direct
 Weight (kg): 3.8
 Weight (lbs): 8.38
 Diffuser: Clear tempered glass
 Fixture Finish: SSS
 Fixture Material: Aluminum Die Cast

ELECTRICAL

Lamp Type: LED (Zhaga Standard)
 Input Wattage (W): 20
 Total Output Wattage (W): 17
 Dimming: Non-Dimming / Phase Dimming (120vac Only)
 Driver Included: Yes
 Driver Location: Integrated
 Driver Type: Constant Current - Universal
 Driver Class: Class 2
 Input Voltage (V): 120 - 277
 Constant Current (mA): 500
 Upon Request: (Not included - see components [IP65 or higher enclosure to be supplied by others]) Remote: 0-10Vdc dimming / (Included) Integral: Phase dimming @120Vac only / 277Vac

LED

Color Temperature (°K): 3000 / 4000
 Max. Delivered Lumen (lm): 2434.9 / 2607.5
 Nominal Lumen (lm): 2750 / 2945
 CRI: >80 CRI
 Lamp Life (hrs): 50000

OPTICAL

Reflector: Metallised polycarbonate reflector - Pivoting 350° and adjustable +/- 15° reflector
 Optic: 15 / 45 / 65 / ASY

RATINGS AND CERTIFICATIONS

Certified By: Certified for North American Standards
 IP rating: IP67
 IK Rating: IK10



 3.80 kg / 8.38 lbs



PROJECT	
TYPE	
SPECIFIER	
QUANTITY	
DATE	

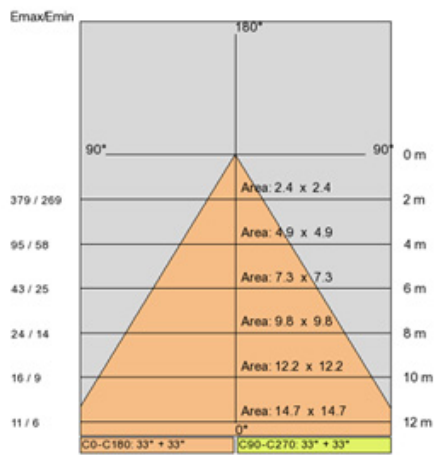

OLODUM RECESSED

E10I0059- _____ - _____

base number Color BA Options
 Temperature

- To build a product code in our configurator select the specify button on the base model # product page
- To build a manual product code on this datasheet choose from the options listed below in blue font and add the suffix to the base model #

GENERAL

Series: Olodum
 Brand: Side
 Division: Exterior
 Mounting Type: Recessed
 Mounting Location: In-Ground
 Subcategory: Uplight

PHYSICAL

Shape: Round
 Diameter (mm): 220
 Diameter (in): 8 11/16
 Height (mm): 242
 Height (in): 9 1/2
 Light Distribution: Adjustable / Direct
 Weight (kg): 3.8
 Weight (lbs): 8.38
 Diffuser: Clear tempered glass
 Gasket: Silicon rubber
 Fixture Finish: SSS
 Fixture Material: Aluminum Die Cast

ELECTRICAL

Lamp Type: LED (Zhaga Standard)
 Input Wattage (W): 20
 Total Output Wattage (W): 17
 Dimming: Tri-Mode (Non-Dimming and Phase Dimming (120Vac only) and 0-10V Dimming)
 Driver Included: Yes
 Driver Location: Integrated
 Driver Type: Constant Current - Universal
 Driver Class: Class 2
 Input Voltage (V): 120 - 277
 Constant Current (MA): 500
 Upon Request: (Not included - see components [IP65 or higher enclosure to be supplied by others]) Remote: 0-10Vdc dimming / (Included) Integral: Phase dimming @120Vac only / 277Vac

LED

Color Temperature (°K): 3000 / 4000
 Max. Delivered Lumen (lm): 2434.9 / 2607.5
 Nominal Lumen (lm): 2750 / 2945
 CRI: >80 CRI
 Lamp Life (hrs): 50000

OPTICAL

Reflector: Polycarbonate metallized reflector
 Optic: 15 / 45 / 65 / ASY

RATINGS AND CERTIFICATIONS

Certified By: Certified for North American Standards
 IP rating: IP67
 IK Rating: IK10

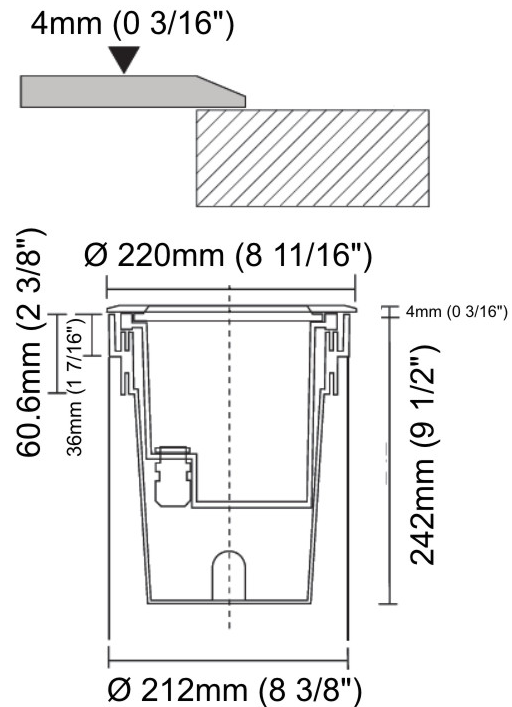

3.80 kg / 8.38 lbs



PROJECT	
TYPE	
SPECIFIER	
QUANTITY	
DATE	

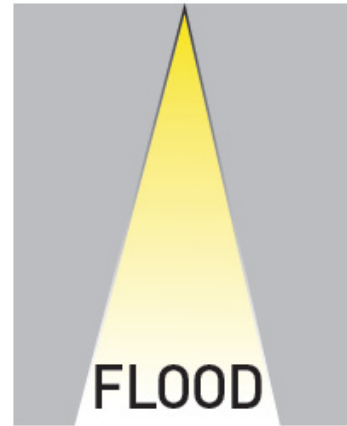
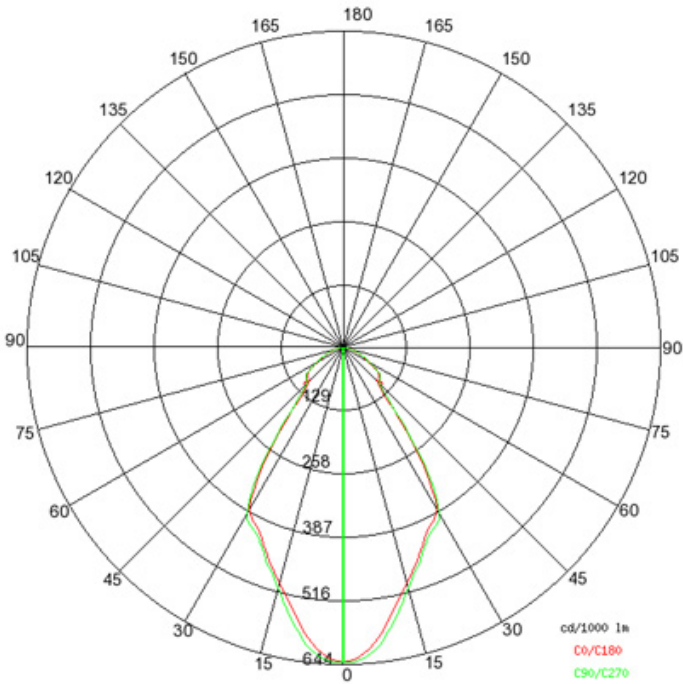

PROJECT	_____
TYPE	_____
SPECIFIER	_____
QUANTITY	_____
DATE	_____

OLODUM ROUND RECESSED

E10I0071- _____ - _____

base number Color BA Options
Temperature

- To build a product code in our configurator select the specify button on the base model # product page
- To build a manual product code on this datasheet choose from the options listed below in blue font and add the suffix to the base model #

GENERAL

Series: Olodum
Subseries: Olodum Round
Brand: Side
Division: Exterior
Mounting Type: Recessed
Mounting Location: In-Ground
Subcategory: Uplight

PHYSICAL

Shape: Round
Diameter (mm): 130
Diameter (in): 5 1/8
Height (mm): 146
Height (in): 5 3/4
Light Distribution: Adjustable / Direct
Weight (kg): 1.9
Weight (lbs): 4.19
Diffuser: Clear tempered glass
Gasket: Silicon rubber
Fixture Finish: SSS
Fixture Material: Aluminum Die Cast

ELECTRICAL

Lamp Type: LED (Zhaga Standard)
Input Wattage (W): 6.8
Total Output Wattage (W): 5.8
Dimming: 0-10V Dimming / Phase Dimming (120Vac Only)
Driver Included: No
Driver Location: Remote
Driver Type: Constant Current - Universal
Input Voltage (V): 120 - 277
Constant Current (MA): 203
Upon Request: (Not included - see components [IP65 or higher enclosure to be supplied by others]) 0-10Vdc dimming / Phase dimming @120Vac only / 277Vac

LED

Color Temperature (°K): 3000 / 4000
Max. Delivered Lumen (lm): 814.5 / 868.8
Nominal Lumen (lm): 1050 / 1120
CRI: >80 CRI
Lamp Life (hrs): 50000

OPTICAL

Reflector: Metallized polycarbonate
Optic: 15 / 30 / 45
Adjustability: Rotational 350°; Tilt ±15°

RATINGS AND CERTIFICATIONS

Certified By: Certified for North American Standards
IP rating: IP67
IK Rating: IK10

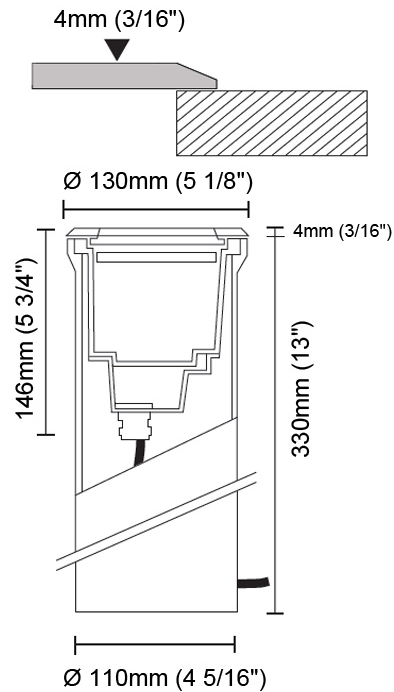

 1.9kg / 4.19lbs



OLODUM ROUND RECESSED

E10I0071-

PROJECT	
TYPE	
SPECIFIER	
QUANTITY	
DATE	

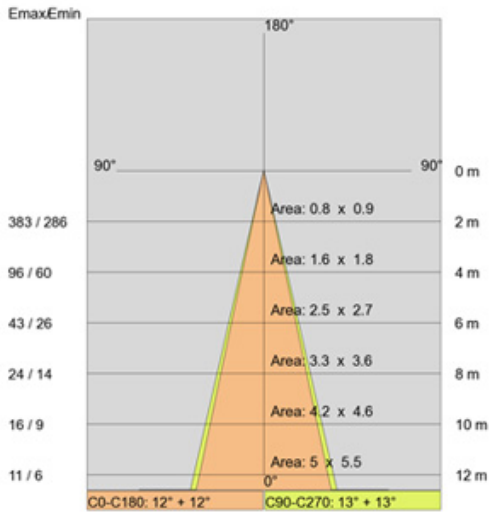
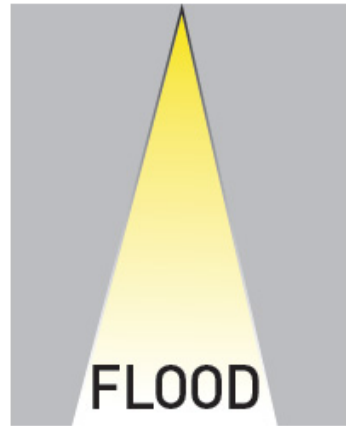
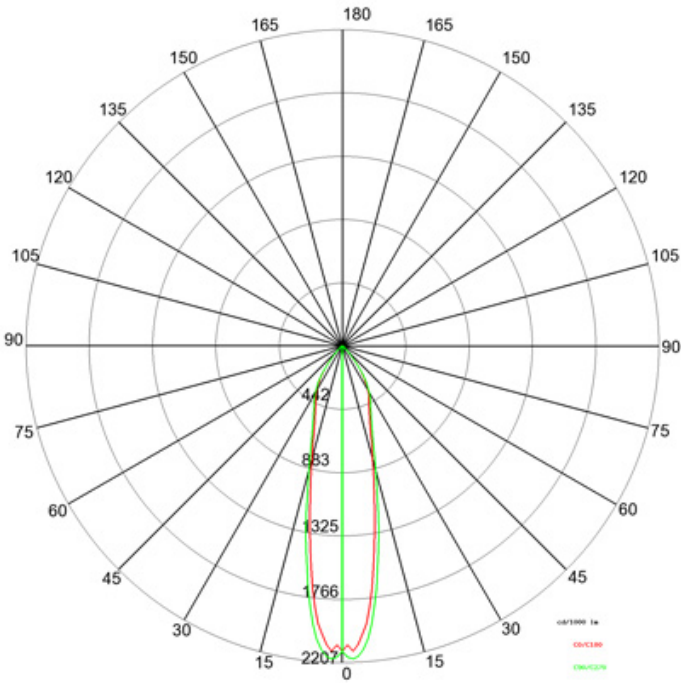

E

PROJECT	
TYPE	
SPECIFIER	
QUANTITY	
DATE	

OLODUM ROUND RECESSED

E10I0093-

base number Color
Temperature

- To build a product code in our configurator select the specify button on the base model # product page
- To build a manual product code on this datasheet choose from the options listed below in blue font and add the suffix to the base model #

GENERAL

Series: Olodum
 Subseries: Olodum Round
 Brand: Side
 Division: Exterior
 Mounting Type: Recessed
 Mounting Location: In-Ground
 Subcategory: Walk Over

PHYSICAL

Shape: Round
 Diameter (mm): 65
 Diameter (in): 2 9/16
 Height (mm): 62
 Height (in): 2 7/16
 Light Distribution: Uplight
 Weight (kg): 0.3
 Weight (lbs): 0.66
 Load Resistance (kg): 500
 Load Resistance (lbs): 1102
 Diffuser: Clear tempered glass
 Gasket: Silicon rubber
 Fixture Finish: SSS
 Fixture Material: Stainless Steel

ELECTRICAL

Lamp Type: LED (Zhaga Standard)
 Input Wattage (W): 3.5
 Total Output Wattage (W): 3
 Driver Included: No
 Input Voltage (V): 120
 Constant Current (MA): 350

LED

Number of LEDs: 1
 Color Temperature (°K): 3000 / 4000
 Max. Delivered Lumen (lm): 285 / 300
 CRI: >80 CRI

OPTICAL

Reflector: Polycarbonate metallized reflector
 Optic: 45

RATINGS AND CERTIFICATIONS

Certified By: Certified for North American Standards
 IP rating: IP67
 IK Rating: IK07

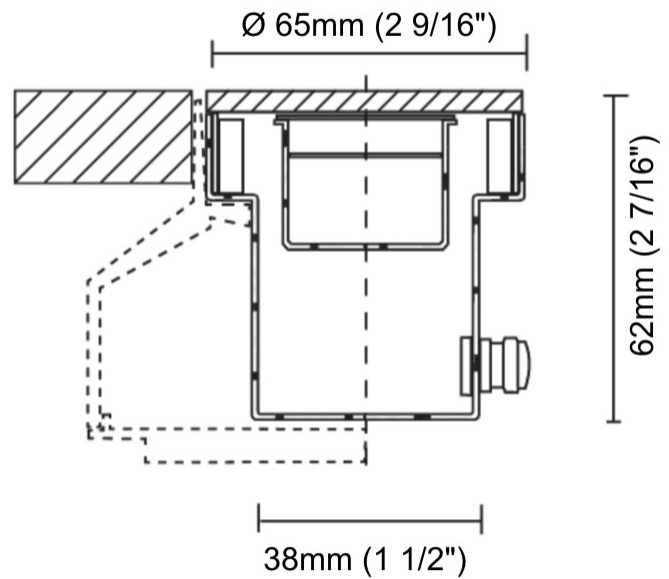
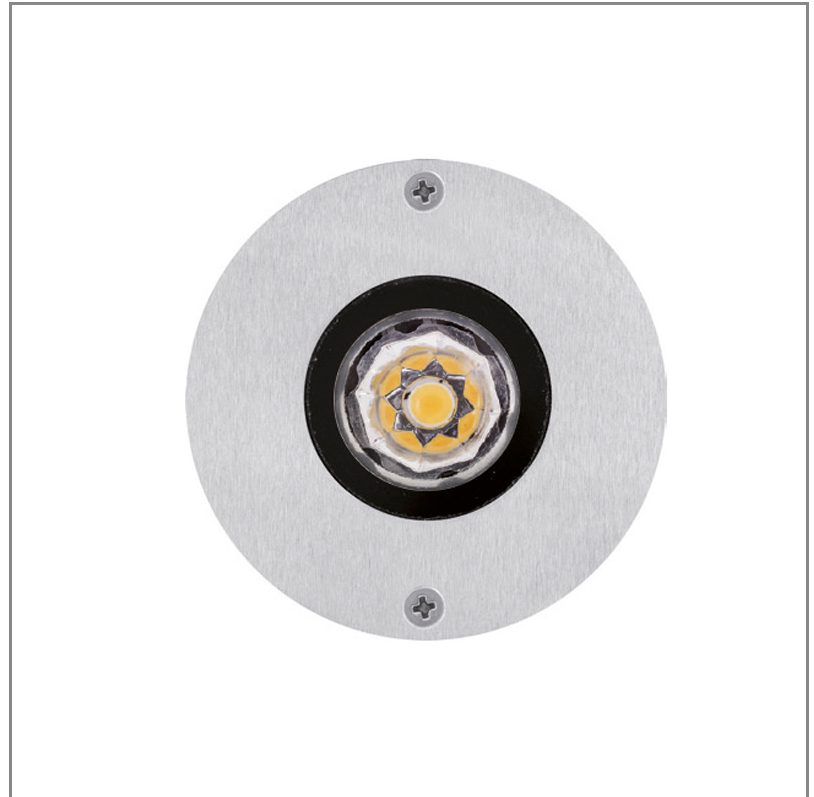

△ 0.3kg / 0.66lbs



OLODUM ROUND RECESSED

E10I0093-

PROJECT	
TYPE	
SPECIFIER	
QUANTITY	
DATE	

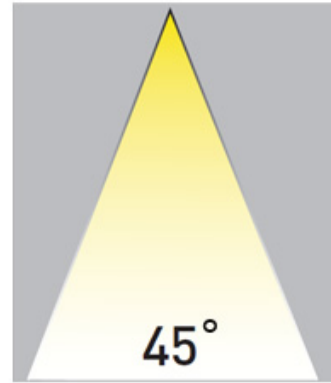
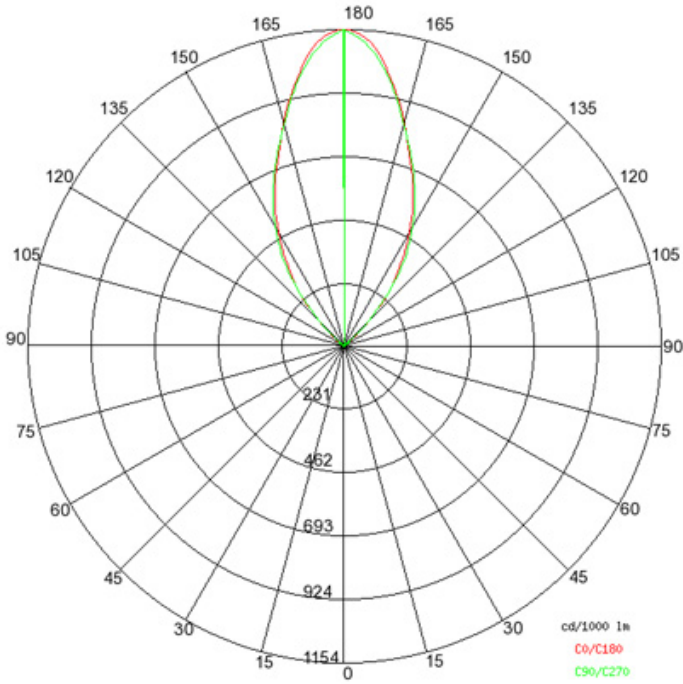

Emax/Emin	180°	
	90°	0 m
	90°	2 m
78 / 22	Area: NAN x NAN	4 m
20 / 8	Area: NAN x NAN	6 m
9 / 4	Area: NAN x NAN	8 m
5 / 3	Area: NAN x NAN	10 m
4 / 2	Area: NAN x NAN	12 m
3 / 2	Area: NAN x NAN	
	0°	
	C0-C180: 154° + 154°	
	C90-C270: 153° + 153°	



PROJECT	_____
TYPE	_____
SPECIFIER	_____
QUANTITY	_____
DATE	_____

OLODUM ROUND RECESSED

E10Q0034-

base number _____ Color _____
 _____ Temperature _____

- To build a product code in our configurator select the specify button on the base model # product page
- To build a manual product code on this datasheet choose from the options listed below in blue font and add the suffix to the base model #

GENERAL

Series: Olodum
 Subseries: Olodum Round
 Brand: Side
 Division: Exterior
 Mounting Type: Recessed
 Mounting Location: Ceiling
 Subcategory: Downlight

PHYSICAL

Shape: Round
 Diameter (mm): 76
 Diameter (in): 3
 Height (mm): 58
 Height (in): 2 5/16
 Min. Recessing Depth (mm): 63
 Min. Recessing Depth (in): 2 1/2
 Light Distribution: Direct
 Weight (kg): 0.4
 Weight (lbs): 0.88
 Diffuser: Clear tempered glass
 Gasket: Silicon rubber
 Fixture Finish: SSS
 Fixture Material: Stainless Steel

ELECTRICAL

Lamp Type: LED (Zhaga Standard)
 Input Wattage (W): 4.4
 Total Output Wattage (W): 3.1
 Dimming: Non-Dimming / Phase Dimming (120Vac only) / 0-10V Dimming
 Driver Included: No
 Driver Location: Remote
 Driver Type: Constant Current - 120 / 277Vac
 Driver Class: Class 2
 Input Voltage (V): 120 - 277
 Constant Current (MA): 350

LED

Color Temperature (°K): 3000 / 4000
 Max. Delivered Lumen (lm): 285 / 300
 Nominal Lumen (lm): 350 / 380
 CRI: >80 CRI
 Lamp Life (hrs): 50000

OPTICAL

Optic°: 45

RATINGS AND CERTIFICATIONS

Certified By: Certified for North American Standards
 IP rating: IP67
 IK Rating: IK07



0.40 kg / 0.88 lbs

61mm (2 3/8")

Recessed Thickness 10 / 12.5 / 15 / 25 / 30 mm
 (3/8" / 1/2" / 9/16" / 1" / 1 3/16")



OLODUM ROUND RECESSED

E10Q0034-

PROJECT	
TYPE	
SPECIFIER	
QUANTITY	
DATE	

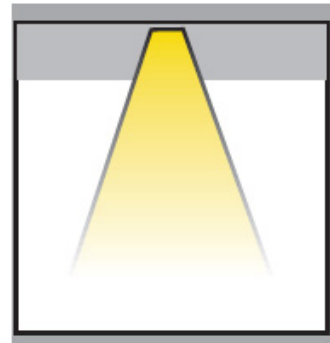

Emax/Emin		180°	
	90°	90°	0 m
		Area: NAN x NAN	2 m
		Area: NAN x NAN	4 m
		Area: NAN x NAN	6 m
		Area: NAN x NAN	8 m
		Area: NAN x NAN	10 m
		Area: NAN x NAN	12 m
	0°		
		C0-C180: 154° + 154°	C90-C270: 153° + 153°

On the left side of the table, an orange triangle is shown with horizontal lines corresponding to the height markers. The triangle's width at each height is labeled as follows: 78 / 22 at 0m, 20 / 8 at 2m, 9 / 4 at 4m, 5 / 3 at 6m, 4 / 2 at 8m, and 3 / 2 at 10m.

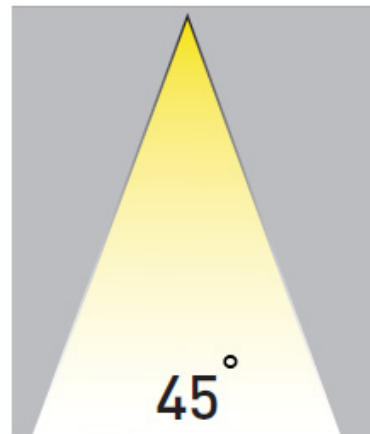

OLODUM RECESSED

E10Q0040- _____ - _____

base number _____ Color _____ BA Options _____
 Temperature _____

- To build a product code in our configurator select the specify button on the base model # product page
- To build a manual product code on this datasheet choose from the options listed below in blue font and add the suffix to the base model #

GENERAL

Series: Olodum _____
 Brand: Side _____
 Division: Exterior _____
 Mounting Type: Recessed _____
 Mounting Location: Ceiling _____
 Subcategory: Downlight _____

PHYSICAL

Shape: Round _____
 Diameter (mm): 220 _____
 Diameter (in): 8 ¹¹/₁₆ _____
 Height (mm): 215 _____
 Height (in): 8 ⁷/₁₆ _____
 Light Distribution: Adjustable / Direct _____
 Weight (kg): 3.6 _____
 Weight (lbs): 7.94 _____
 Diffuser: Clear tempered glass _____
 Fixture Finish: SSS _____
 Fixture Material: Aluminum Die Cast _____

ELECTRICAL

Lamp Type: LED (Zhaga Standard) _____
 Input Wattage (W): 20 _____
 Total Output Wattage (W): 17 _____
 Dimming: Tri-Mode (Non-Dimming and Phase Dimming (120Vac only) and 0-10V Dimming) _____
 Driver Included: Yes _____
 Driver Location: Integrated _____
 Driver Type: Constant Current - Universal _____
 Driver Class: Class 2 _____
 Input Voltage (V): 120 - 277 _____
 Constant Current (MA): 500 _____
 Upon Request: (Not included - see components [IP65 or higher enclosure to be supplied by others]) 0-10Vdc dimming / (Included) Integral: Phase dimming @120Vac only / 277Vac _____

LED

Color Temperature (°K): 3000 / 4000 _____
 Max. Delivered Lumen (lm): 2434.9 / 2607.5 _____
 Nominal Lumen (lm): 2750 / 2945 _____
 CRI: >80 CRI _____
 Lamp Life (hrs): 50000 _____

OPTICAL

Reflector: Polycarbonate metallized reflector _____
 Optic: 15 / 45 / 65 / ASY _____

RATINGS AND CERTIFICATIONS

Certified By: Certified for North American Standards _____
 IP rating: IP67 _____
 IK Rating: IK10 _____

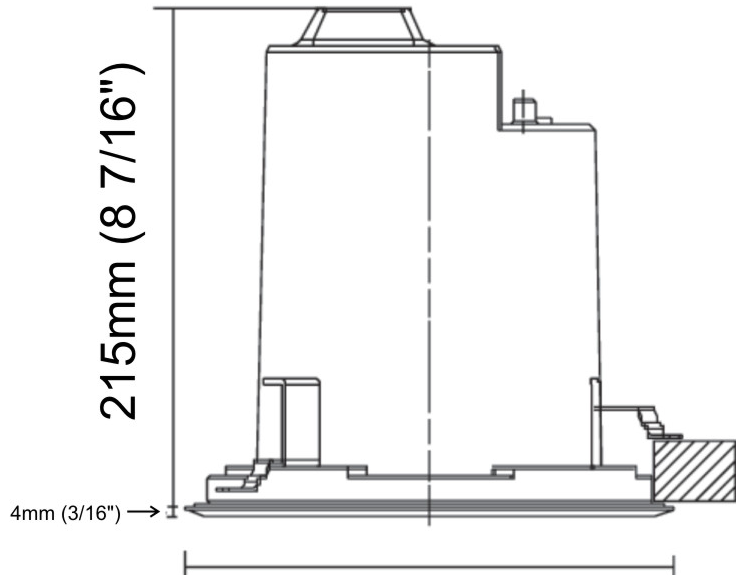

220mm (8 11/16")

Recessed Thickness 10 / 12.5 / 15 / 25 / 30 mm
 (3/8" / 1/2" / 9/16" / 1" / 1 3/16")

201mm (7 15/16")
 3.6kg / 7.93lbs



PROJECT	
TYPE	
SPECIFIER	
QUANTITY	
DATE	

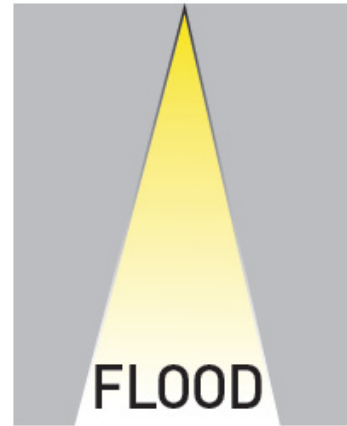
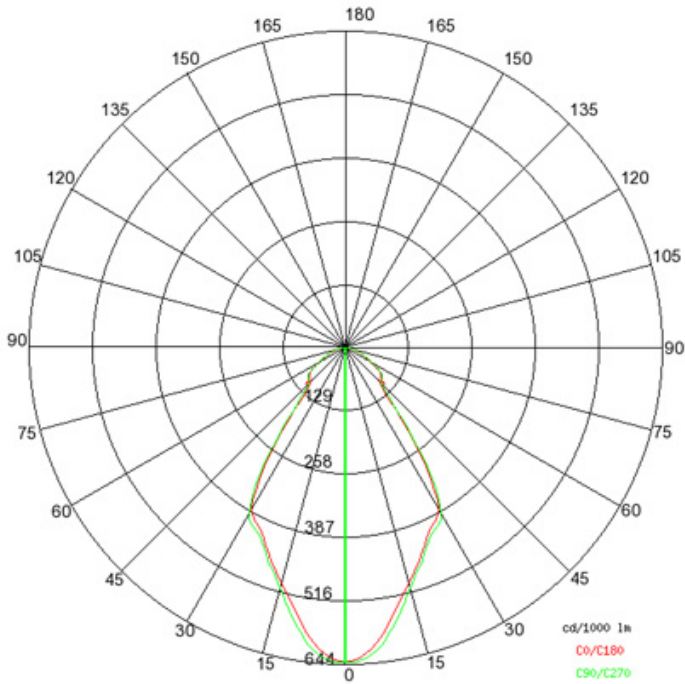

PROJECT	_____
TYPE	_____
SPECIFIER	_____
QUANTITY	_____
DATE	_____

OLODUM RECESSED

E10Q0046- _____ - _____

base number Color BA Options
 _____ Temperature _____

- To build a product code in our configurator select the specify button on the base model # product page
- To build a manual product code on this datasheet choose from the options listed below in blue font and add the suffix to the base model #

GENERAL

Series: Olodum
 Brand: Side
 Division: Exterior
 Mounting Type: Recessed
 Mounting Location: Ceiling
 Subcategory: Downlight

PHYSICAL

Shape: Round
 Diameter (mm): 220
 Diameter (in): 8 11/16
 Height (mm): 215
 Height (in): 8 7/16
 Light Distribution: Adjustable / Direct
 Weight (kg): 3.6
 Weight (lbs): 7.94
 Diffuser: Clear tempered glass
 Fixture Finish: SSS
 Fixture Material: Aluminum Die Cast

ELECTRICAL

Lamp Type: LED (Zhaga Standard)
 Input Wattage (W): 20
 Total Output Wattage (W): 17
 Dimming: Tri-Mode (Non-Dimming and Phase Dimming (120Vac only) and 0-10V Dimming)
 Driver Included: Yes
 Driver Location: Integrated
 Driver Type: Constant Current - Universal
 Driver Class: Class 2
 Input Voltage (V): 120 - 277
 Constant Current (MA): 500
 Upon Request: (Not included - see components [IP65 or higher enclosure to be supplied by others]) 0-10Vdc dimming / (Included) Integral: Phase dimming @120Vac only / 277Vac

LED

Color Temperature (°K): 3000 / 4000
 Max. Delivered Lumen (lm): 2434.9 / 2587.5
 Nominal Lumen (lm): 2750 / 2945
 CRI: >80 CRI
 Lamp Life (hrs): 50000

OPTICAL

Reflector: Polycarbonate metallized reflector
 Beam Angle: Spot - 15° / Flood - 45° / Wide Flood - 65° / Asymmetric

RATINGS AND CERTIFICATIONS

Certified By: Certified for North American Standards
 IP rating: IP67
 IK Rating: IK10

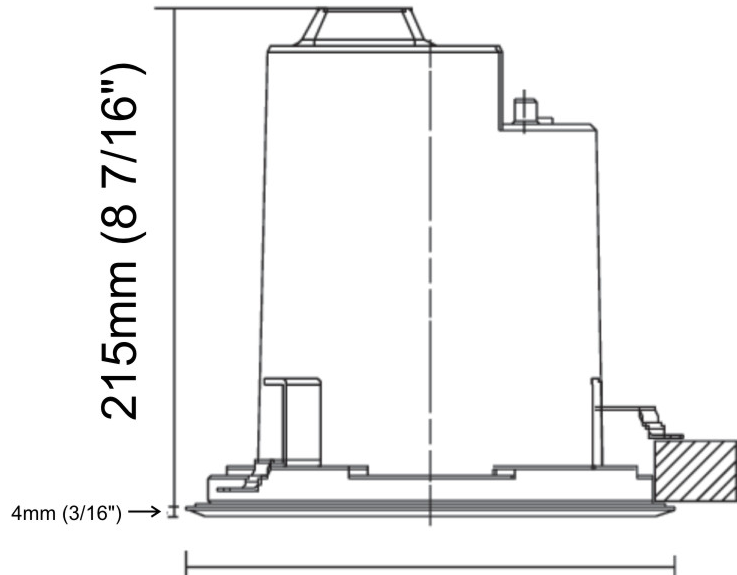

220mm (8 11/16")

Recessed Thickness 10 / 12.5 / 15 / 25 / 30 mm
 (3/8" / 1/2" / 9/16" / 1" / 1 3/16")



201mm (7 15/16")
 3.6kg / 7.93lbs

PROJECT	
TYPE	
SPECIFIER	
QUANTITY	
DATE	

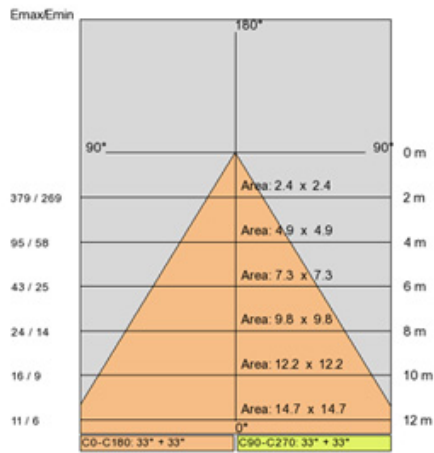
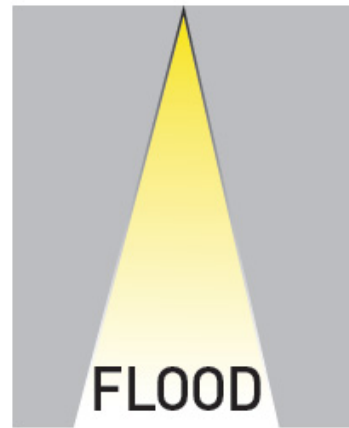
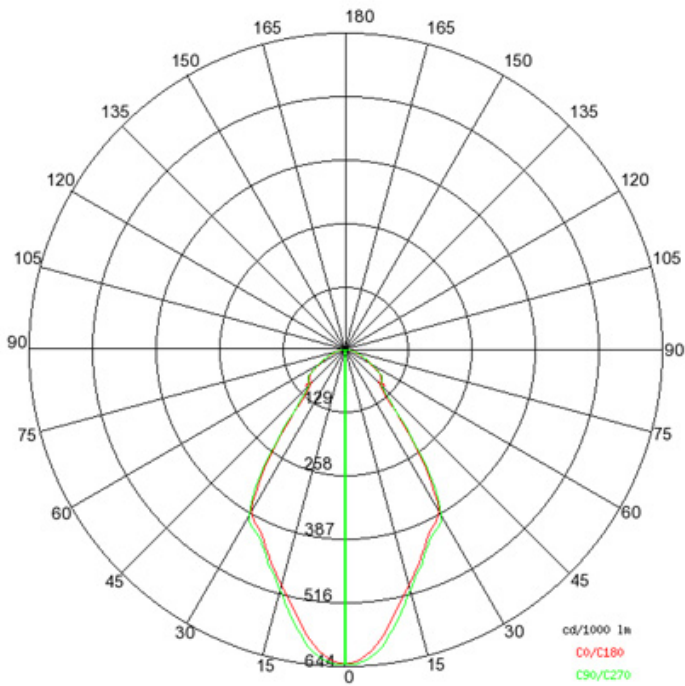

OLODUM ROUND RECESSED

E10Q0052- -

base number Color BA Options
 Temperature

- To build a product code in our configurator select the specify button on the base model # product page
- To build a manual product code on this datasheet choose from the options listed below in blue font and add the suffix to the base model #

GENERAL

Series: Olodum
 Subseries: Olodum Round
 Brand: Side
 Division: Exterior
 Mounting Type: Recessed
 Mounting Location: Ceiling
 Subcategory: Downlight

PHYSICAL

Shape: Round
 Diameter (mm): 130
 Diameter (in): 5 1/8
 Height (mm): 132
 Height (in): 5 3/16
 Light Distribution: Downlight
 Weight (kg): 1.450
 Weight (lbs): 3.2
 Diffuser: Clear tempered glass
 Gasket: Silicon rubber
 Fixture Finish: SSS
 Fixture Material: Aluminum Die Cast

ELECTRICAL

Lamp Type: LED (Zhaga Standard)
 Input Wattage (W): 6.8
 Total Output Wattage (W): 5.8
 Dimming: 0-10V Dimming / Phase Dimming (120Vac Only)
 Driver Included: No
 Driver Location: Remote
 Driver Type: Constant Current - Universal
 Driver Class: Class 2
 Input Voltage (V): 120 - 277
 Constant Current (MA): 203
 Upon Request: (Not included - see components [IP65 or higher enclosure to be supplied by others]) 0-10Vdc dimming / Phase dimming @120Vac only / 277Vac

LED

Color Temperature (°K): 3000 / 4000
 Max. Delivered Lumen (lm): 814.5 / 868.5
 CRI: >80 CRI
 Lamp Life (hrs): 50000

OPTICAL

Reflector: Polycarbonate metallized reflector
 Optic: 15 / 30 / 45

RATINGS AND CERTIFICATIONS

Certified By: Certified for North American Standards
 IP rating: IP67
 IK Rating: IK10

PROJECT
TYPE
SPECIFIER
QUANTITY
DATE

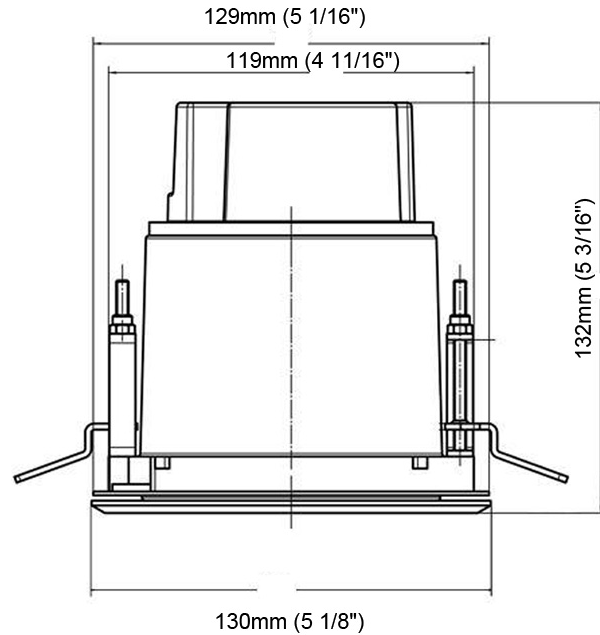

1.45kg / 3.2lbs

Recessed Thickness 10 / 12.5 / 15 mm (3/8" / 1/2" / 9/16")

127mm (5")



OLODUM ROUND RECESSED

E10Q0052-

PROJECT	
TYPE	
SPECIFIER	
QUANTITY	
DATE	

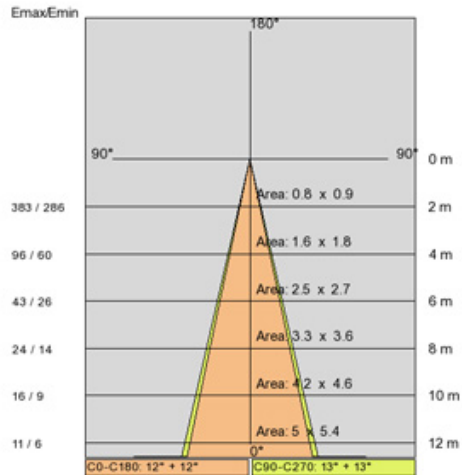
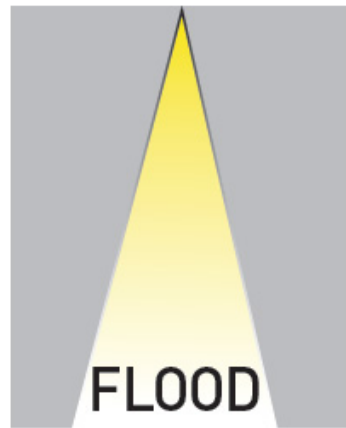
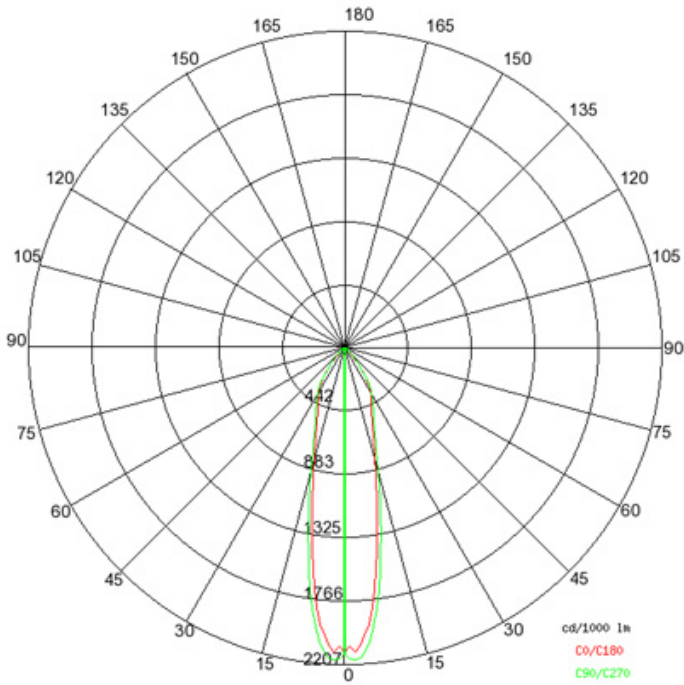

E

PROJECT	
TYPE	
SPECIFIER	
QUANTITY	
DATE	

OLODUM RECESSED

E10Q0058- -

base number Color Lens
 Temperature Options

- To build a product code in our configurator select the specify button on the base model # product page
- To build a manual product code on this datasheet choose from the options listed below in blue font and add the suffix to the base model #

GENERAL

Series: Olodum
 Brand: Side
 Division: Exterior
 Mounting Type: Recessed
 Mounting Location: Ceiling

PHYSICAL

Shape: Round
 Diameter (mm): 180
 Diameter (in): 7 1/16
 Height (mm): 250
 Height (in): 9 13/16
 Light Distribution: Direct
 Weight (kg): 3.4
 Weight (lbs): 7.5
 Diffuser: Clear Tempered Glass
 Fixture Finish: SSS
 Fixture Material: Aluminum Die Cast

ELECTRICAL

Lamp Type: LED (Zhaga Standard)
 Input Wattage (W): 9.1

LED

Number of LEDs: 1
 Color Temperature (°K): 3000 / 4000
 Max. Delivered Lumen (lm): 1157 / 1239
 Nominal Lumen (lm): 1410 / 1510
 CRI: >90 CRI

OPTICAL

Reflector: Polycarbonate metallized reflector
 Optic: 15° / 30° / 45°

RATINGS AND CERTIFICATIONS

Certified By: CSA Certified to UL and CSA Standards
 IP rating: IP67
 IK Rating: IK10

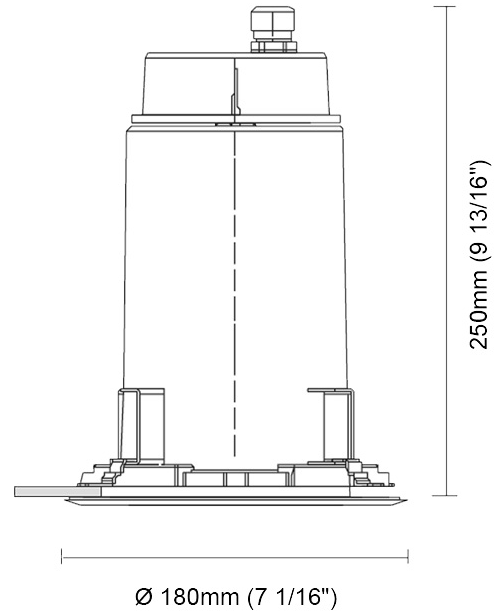

180mm (7 1/16")
 3.4kg / 7.49lbs
 Recessed Thickness: 10 / 12.5 / 15 mm (3/8" / 1/2" / 9/16")



PROJECT
TYPE
SPECIFIER
QUANTITY
DATE

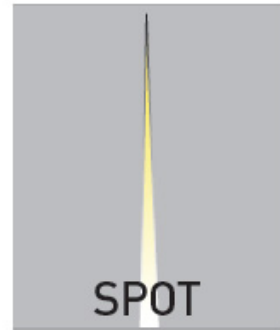
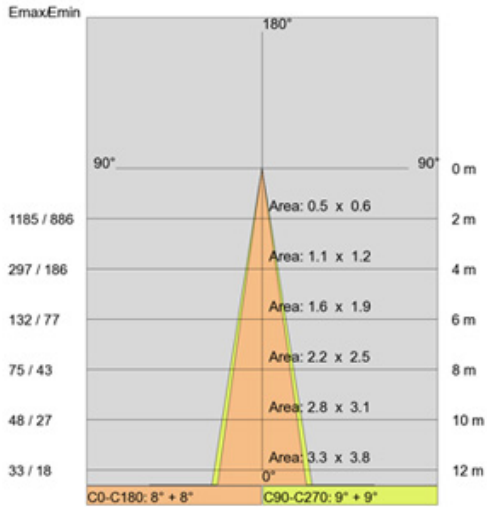
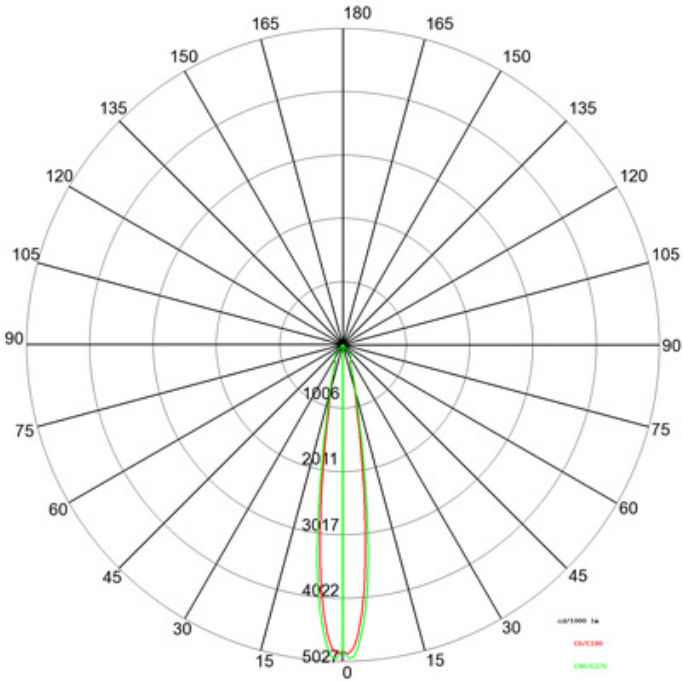

PROJECT

TYPE

SPECIFIER

QUANTITY

DATE

Fixture Finish

Satined Stainless Steel - SSS



Digital: Not all screens are calibrated the same, and therefore, colors will appear differently between screens.

Physical: When texture is involved, there will be variations in color, character and tone within a product series and between product families.



LEGEND

	floor-mounted		pivotable		special LED (upon request) RGB, RGBW, tunable, gold+, meat+, art+, fashion+
	wall and ceiling: recessed and surface mounted		rotating		warm dim / natural dimming LED
	ceiling-mounted and wall-mounted		illuminate tilted		rechargeable battery powered
	wall-mounted		color of suspension cable		fixture with natural vivid LED (upon request)
	omni-directional light distribution		length of suspension cable		color rendering index
	direct light distribution		reflector degree selection		color temperature
	direct/indirect light distribution		super spot		lumen (luminous flux)
	indirect light distribution		lens		efficacy (lumens per watt)
	asymmetric light distribution		lens pack		Unified Glare Rating (UGR) range from 5-40
	aura light distribution		shine ring		marine grade (AISI 316 stainless steel)
	round wall or ceiling cut-out		integrated shine ring with diffuser		walk on
	square wall or ceiling cut-out		free individual colors 01-29		drive on
	the supplied jig specifies the cutout dimensions		individual colors: 00 (free of charge), 01-25 (extra charge)		Dark Sky Compliance
	minimum distance (meters) lamp - object		luminaire part to be colored (F1)		Americans with Disabilities Act (less than 4" off the wall located between 27"-84" from floor)
	recessed depth		luminaire part to be colored (F2)		lamp protected against explosion
	ceiling thickness in mm		luminaire part to be colored (F3)		blown glass using traditional methods by master glass blower
	ceiling thickness selection		luminaire part to be colored (F4)		acoustic material
	dimmable DP (phase), DV (0-10V), DD (dali), DS (step-dim)		luminaire part to be colored (F5)		protection class I, protection insulation
	included or excluded LED driver/transformer/control gear		color of 3-circuit adaptor		protection class II, protection insulation
	separately switchable		indirect diffuser		ETL Certified to UL and CSA Standards
	sensor		direct diffuser		UL Certified to UL and CSA Standards
	remote control		ball-proof (upon request)		CSA Certified to UL and CSA Standards
	available upon request		accessory		Certified for North American Standards

IP RATING

	protected against ingress of solid bodies greater than 12.5mm (finger)
	protected against ingress of solid bodies greater than 2.5mm protected against sprays of water up to 60 degrees from the vertical (rain)
	protected against ingress of solid bodies greater than 1mm (wire) no protection against the ingress of moisture
	protected against ingress of solid bodies greater than 1mm (wire) protected against sprays of water up to 60 degrees from the vertical (rain)
	protected against ingress of solid bodies greater than 1mm (wire) protected against water splashed from all directions
	protected against limited ingress of dust (wet rooms/covered outdoor areas) protected against water splashed from all directions
	protected against ingress of dust protected against jets of water
	protected against ingress of dust protected against powerful jets of water or heavy seas
	protected against ingress of dust protected against immersion of water between 15cm - 1m for 30 minutes
	protected against ingress of dust protected against immersion of water under pressure for long periods

IK RATING

	protected against 0.14 joules impact (equivalent to 0.25kg mass dropped from 56mm above the surface)
	protected against 0.2 joules impact (equivalent to 0.25kg mass dropped from 80mm above the surface)
	protected against 0.35 joules impact (equivalent to 0.25kg mass dropped from 140mm above the surface)
	protected against 0.5 joules impact (equivalent to 0.25kg mass dropped from 200mm above the surface)
	protected against 0.7 joules impact (equivalent to 0.25kg mass dropped from 280mm above the surface)
	protected against 1 joules impact (equivalent to 0.25kg mass dropped from 400mm above the surface)
	protected against 2 joules impact (equivalent to 0.5kg mass dropped from 400mm above the surface)
	protected against 5 joules impact (equivalent to 1.7kg mass dropped from 300mm above the surface)
	protected against 10 joules impact (equivalent to 5.0kg mass dropped from 200mm above the surface)
	protected against 20 joules impact (equivalent to 5.0kg mass dropped from 400mm above the surface)