

PROJECT	
TYPE	
SPECIFIER	
QUANTITY	
DATE	

ONNA SUSPENSION

D111183-

base number	Finish Options	Finish Options	Finish Options
-------------	----------------	----------------	----------------

- To build a product code in our configurator select the specify button on the base model # product page
- To build a manual product code on this datasheet choose from the options listed below in blue font and add the suffix to the base model #

GENERAL

Series: Onna
Brand: Ole
Division: Design
Mounting Type: Suspension
Mounting Location: Ceiling
Subcategory: Pendant

PHYSICAL

Shape: Abstract
Diameter (mm): 420
Diameter (in): 16 ⁹ / ₁₆
Height (mm): 360
Height (in): 14 ³ / ₁₆
Max. Overall Height (mm): 2360
Max. Overall Height (in): 95 ¹⁵ / ₁₆
Light Distribution: Omnidirectional
Fixture Finish: BEI / BLK / BLU / COG / DGN / GRY / MRN / MOC / MUS / OLV / SIL / STN / TER / WHI
Holder Finish: MWH/MBK/CHR/SNI
Accent Finish: MWH / MBK
Fixture Material: Fabric Cord / Metal
Cable Details: 2000mm/78 3/4" Transparent Cable

ELECTRICAL

Number of Lamps: 1
Lamp Type: LED Retrofit
Lamp Shape: A19
Bulb Included: Bulb Not Included
Max. Wattage Per Lamp (W): 20
Lamp Base: E26
Input Voltage (V): 120
Upon Request: 277Vac / GU24

LED

OPTICAL

RATINGS AND CERTIFICATIONS

Certified By: Certified for North American Standards
IP rating: IP20

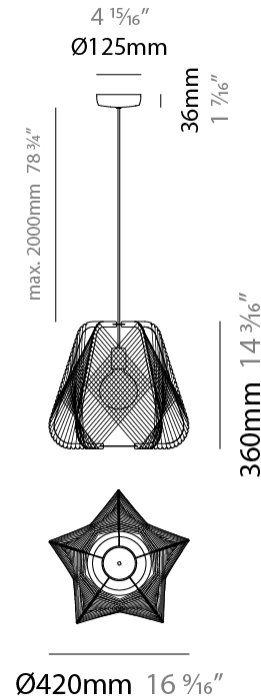

ONNA SUSPENSION

D111183-

PROJECT

TYPE

SPECIFIER

QUANTITY

DATE

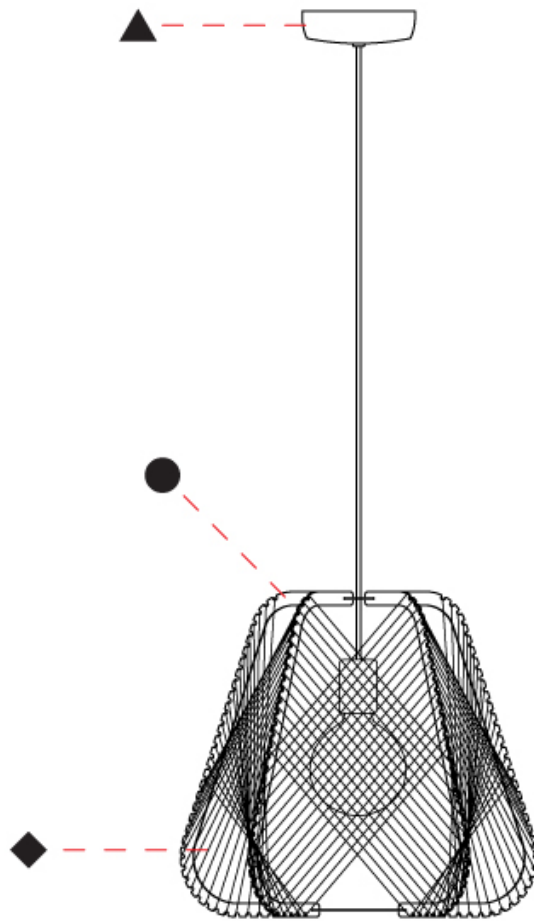

D

ONNA SUSPENSION

D111184-

base number Finish Options Finish Options Finish Options

- To build a product code in our configurator select the specify button on the base model # product page
- To build a manual product code on this datasheet choose from the options listed below in blue font and add the suffix to the base model #

GENERAL

Series: Onna
 Brand: Ole
 Division: Design
 Mounting Type: Suspension
 Mounting Location: Ceiling
 Subcategory: Pendant

PHYSICAL

Shape: Abstract
 Diameter (mm): 520
 Diameter (in): 20 1/2
 Height (mm): 360
 Height (in): 14 3/16
 Max. Overall Height (mm): 2360
 Max. Overall Height (in): 95 15/16
 Light Distribution: Omnidirectional
 Fixture Finish: BEI / BLK / BLU / COG / DGN / GRY / MRN / MOC / MUS / OLV / SIL / STN / TER / WHI
 Holder Finish: MWH/MBK/CHR/SNI
 Accent Finish: MWH / MBK
 Fixture Material: Fabric Cord / Metal
 Cable Details: 2000mm/78 3/4" Transparent Cable

ELECTRICAL

Number of Lamps: 1
 Lamp Type: LED Retrofit
 Bulb Included: Bulb Not Included
 Max. Wattage Per Lamp (W): 20
 Lamp Base: E26
 Input Voltage (V): 120
 Upon Request: 277Vac / GU24

LED

OPTICAL

RATINGS AND CERTIFICATIONS

Certified By: Certified for North American Standards
 IP rating: IP20

PROJECT
TYPE
SPECIFIER
QUANTITY
DATE

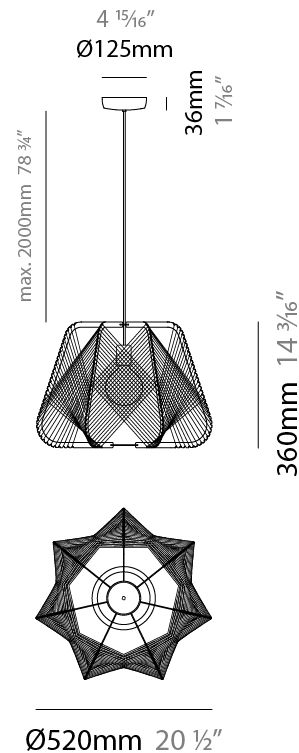

ONNA SUSPENSION

D111184-

PROJECT

TYPE

SPECIFIER

QUANTITY

DATE

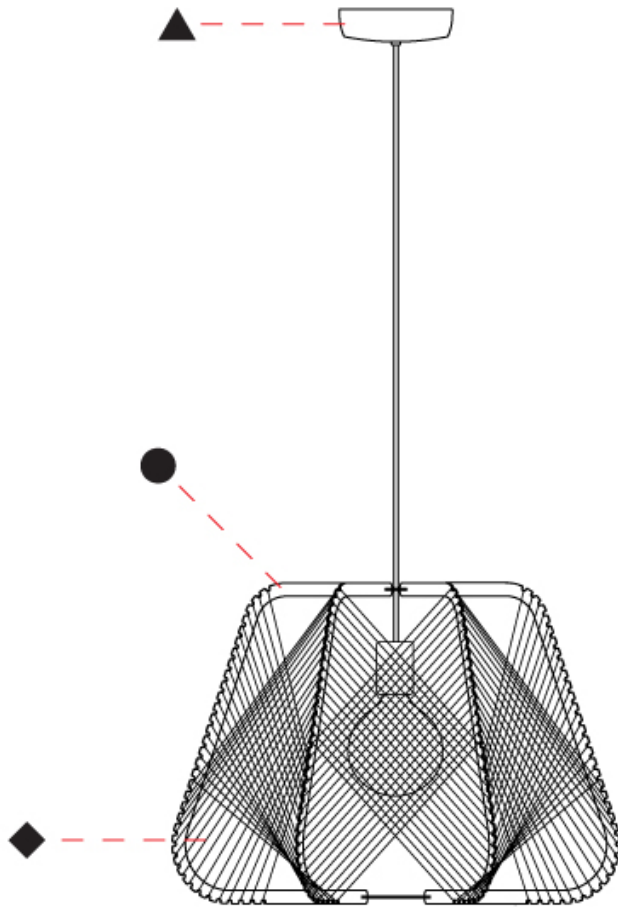

D

ONNA PORTABLE

D114024-

base number Finish Options Finish Options

- To build a product code in our configurator select the specify button on the base model # product page
- To build a manual product code on this datasheet choose from the options listed below in blue font and add the suffix to the base model #

GENERAL

Series: Onna
 Brand: Ole
 Division: Design
 Mounting Type: Portable
 Mounting Location: Table
 Subcategory: Ambient

PHYSICAL

Shape: Abstract
 Diameter (mm): 300
 Diameter (in): 11 ¹³/₁₆
 Height (mm): 280
 Height (in): 11
 Light Distribution: Omnidirectional
 Fixture Finish: BEI / BLK / BLU / COG / DGN / GRY / MRN / MOC / MUS / OLV / SIL / STN / TER / WHI
 Holder Finish: MWH / MBK
 Fixture Material: Fabric Cord / Metal
 Cable Details: 20/120 Cord

ELECTRICAL

Number of Lamps: 1
 Lamp Type: LED Retrofit
 Lamp Shape: A19
 Bulb Included: Bulb Not Included
 Max. Wattage Per Lamp (W): 15
 Lamp Base: E26
 Input Voltage (V): 120
 Upon Request: 277Vac / GU24

LED

OPTICAL

RATINGS AND CERTIFICATIONS

Certified By: Certified for North American Standards
 IP rating: IP20

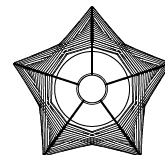
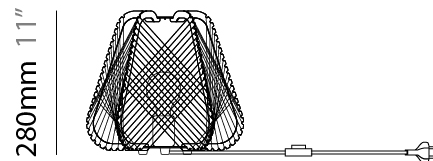

Ø300mm 11 ¹³/₁₆"



ONNA PORTABLE

D114024-

PROJECT

TYPE

SPECIFIER

QUANTITY

DATE

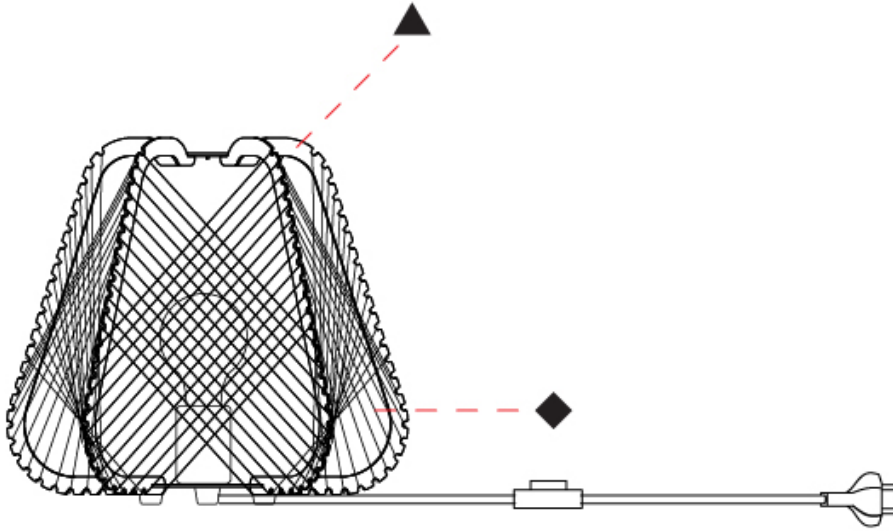

D

PROJECT	
TYPE	
SPECIFIER	
QUANTITY	
DATE	

ONNA PORTABLE

D114025-

base number	Finish Options	Finish Options
-------------	----------------	----------------

- To build a product code in our configurator select the specify button on the base model # product page
- To build a manual product code on this datasheet choose from the options listed below in blue font and add the suffix to the base model #

GENERAL

Series: Onna
Brand: Ole
Division: Design
Mounting Type: Portable
Mounting Location: Floor
Subcategory: Ambient

PHYSICAL

Shape: Abstract
Diameter (mm): 520
Diameter (in): 20 1/2
Height (mm): 1660
Height (in): 65 3/8
Light Distribution: Omnidirectional
Fixture Finish: BEI / BLK / BLU / COG / DGN / GRY / MRN / MOC / MUS / OLV / SIL / STN / TER / WHI
Holder Finish: MWH / MBK
Accent Finish: MWH / MBK
Fixture Material: Fabric Cord / Metal
Cable Details: 100/100 Cord

ELECTRICAL

Number of Lamps: 1
Lamp Type: LED Retrofit
Lamp Shape: A19
Bulb Included: Bulb Not Included
Max. Wattage Per Lamp (W): 15
Lamp Base: E26
Input Voltage (V): 120
Upon Request: 277Vac / GU24

LED

OPTICAL

RATINGS AND CERTIFICATIONS

Certified By: Certified for North American Standards
IP rating: IP20

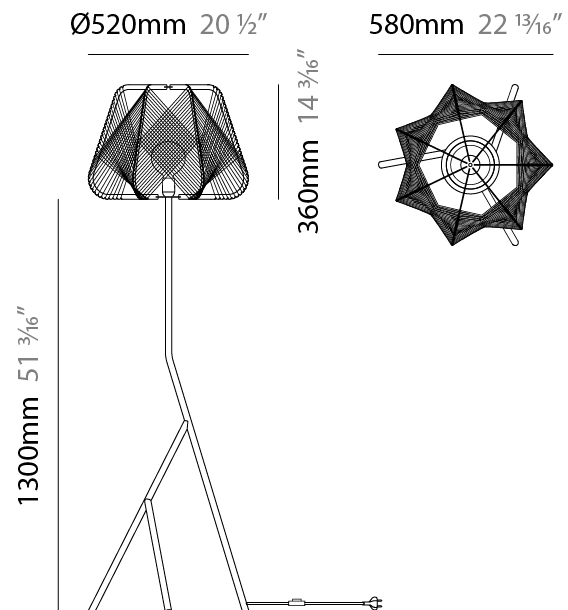

ONNA PORTABLE

D114025-

PROJECT	_____
TYPE	_____
SPECIFIER	_____
QUANTITY	_____
DATE	_____

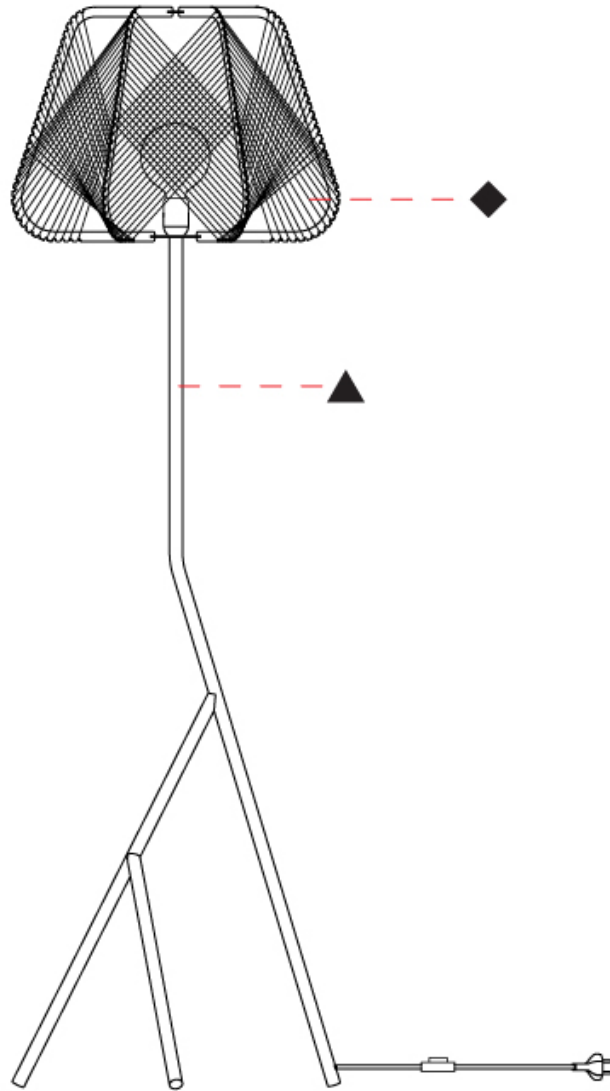

D

PROJECT _____
TYPE _____
SPECIFIER _____
QUANTITY _____
DATE _____

Fixture Finish

Beige - BEI



Black - BLK



Blue - BLU



Cognac - COG



Dark Green - DGN



Gray - GRY



Maroon - MRN



Mocha - MOC



Mustard - MUS



Olive - OLV



Silver - SIL



Stone - STN



Terracotta - TER



White - WHI



Holder Finish

Matte White - MWH

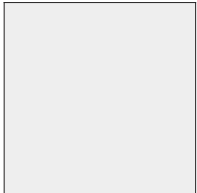

Matte Black - MBK



Chrome - CHR

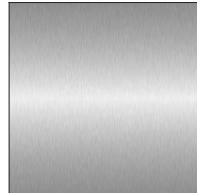

Satin Nickel - SNI

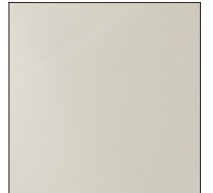

ONNA SUSPENSION, PORTABLE COLOR FINISH CHART

PROJECT

TYPE

SPECIFIER

QUANTITY

DATE

Accent Finish

Matte White - MWH

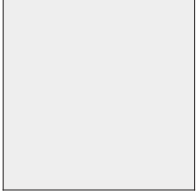

Matte Black - MBK



Digital: Not all screens are calibrated the same, and therefore, colors will appear differently between screens.

Physical: When texture is involved, there will be variations in color, character and tone within a product series and between product families.



COLOR FINISH CHART

BEIGE - BEI
 Pant. 727C 196



BLACK - BLK
 Pant. BLACK C 211



BLUE - BLU
 Pant. 653C 61



COGNAC - COG
 Pant. BLACK C 255



DARK GREEN - DGN
 Pant. 5616C 301



GRAY - GRY
 Pant. 10C 120



MAROON - MRN
 Pant. 1955C 224



MOCHA - MOC
 Pant. 7504C 175



MUSTARD - MUS
 Pant. 1245C 168



OLIVE - OLV
 Pant. 5625C 323



SILVER - SIL
 Pant. 7C 129



STONE - STN
 Pant. 7528C 1196



TERRACOTTA - TER
 Pant. 153C 205



WHITE - WHI
 Pant. WHITE 71



Digital: Not all screens are calibrated the same, and therefore, colors will appear differently between screens.

Physical: When texture is involved, there will be variations in color, character and tone within a product series and between product families.

COMPLETE COLOR FINISH CHART

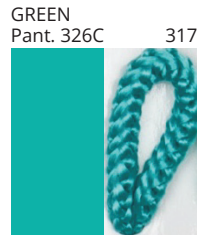
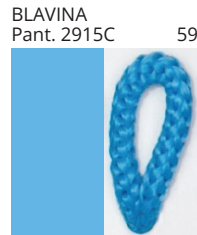
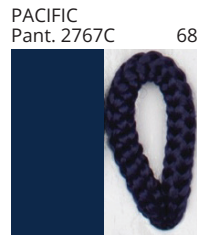
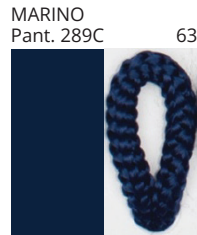
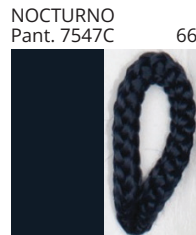
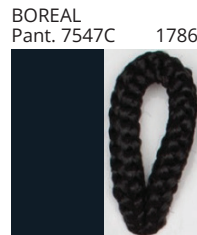
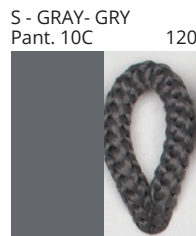
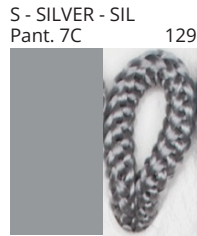
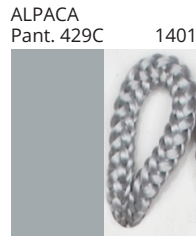

Standard Colors with [S-]

Other fabric cord colors available upon request. Price increase and minimum quantities may apply

Digital: Not all screens are calibrated the same, and therefore, colors will appear differently between screens.

Physical: When texture is involved, there will be variations in color, character and tone within a product series and between product families.

Zaneen Group Inc. © 2024, T 1800-388-3382, F 416-247-9319, www.zaneen.com

Available for International specifications by adding 'INT' at the end of the existing Model #. For assistance on 'custom' specifications, contact zteam@zaneen.com.

In a constant effort to supply the best product, we reserve the right to change specifications or materials without notice. The most recent specification sheets are found at zaneen.com

COMPLETE COLOR FINISH CHART

JADE
 Pant. 3268C 311



VERDE BILLAR
 Pant. 340C 353



JUNGLA
 Pant. 356C 310



VERDE OSC.
 Pant. 3298C 358



MUSGO
 Pant. 5535C 320



S - DARK GREEN
 Pant. 5616C 301



S - OLIVE
 Pant. 5625C 323



CIRUELA
 Pant. 368C 104



LAVANDA
 Pant. 374C 2214



CRUDO
 Pant. 7401C 170



OPALE
 Pant. 402 1442



S - STONE - STN
 Pant. 7528C 1196



ASTRACAN
 Pant. 7529C 101



CAMELLO
 Pant. 731C 161



CASTANO
 Pant. 4625C 1674



TABACO
 Pant. 1545C 203



MARRON
 Pant. 476C 187



MARRON SUPER
 Pant. BLACK 4C 189



MADERA
 Pant. 7519C 2183



S - MOCHA
 Pant. 7504C 175



AVELLANA
 Pant. 729C 152



S - BEIGE - BEI
 Pant. 727C 196



ARENA
 Pant. 465C 151



BEIGE / CAMEL
 Pant. 1265C 154



Standard Colors with [S-]

Other fabric cord colors available upon request. Price increase and minimum quantities may apply

Digital: Not all screens are calibrated the same, and therefore, colors will appear differently between screens.

Physical: When texture is involved, there will be variations in color, character and tone within a product series and between product families.

Zaneen Group Inc. © 2024, T 1800-388-3382, F 416-247-9319, www.zaneen.com

Available for International specifications by adding 'INT' at the end of the existing Model #. For assistance on 'custom' specifications, contact zteam@zaneen.com.

In a constant effort to supply the best product, we reserve the right to change specifications or materials without notice. The most recent specification sheets are found at zaneen.com

COMPLETE COLOR FINISH CHART

ORO
Pant. 872C 16



GOLDEN
Pant. 7403C 7



S - MUSTARD
Pant. 1245C 168



CANARIO
Pant. 106C 9



MIMOSA
Pant. 108C 15



AMARILLO
Pant. 109U 1



NECTAR
Pant. 137C 1871



LAVA
Pant. 151C 1334



NARANJA
Pant. 164C 87



S - TERRACOTTA
Pant. 153C 205



CALABAZA
Pant. 158C 84



ARCILLA
Pant. 1675C 150



ROJO
Pant. 186C 241



FUEGO
Pant. 185C 245



SATAN
Pant. 207C 19



S - MAROON
Pant. 1955C 224



CLARETE
Pant. 209C 240



BURDEOS
Pant. 188C 163



RUBINA
Pant. 229C 285



FRESILLA
Pant. 695C 273



PURPURA
Pant. 215C 276



CICLAMOR
Pant. 205C 264



FUCSIA
Pant. 212C 267



PESCA
Pant. 218C 275



Standard Colors with [S-]

Other fabric cord colors available upon request. Price increase and minimum quantities may apply

Digital: Not all screens are calibrated the same, and therefore, colors will appear differently between screens.

Physical: When texture is involved, there will be variations in color, character and tone within a product series and between product families.

Zaneen Group Inc. © 2024, T 1800-388-3382, F 416-247-9319, www.zaneen.com

Available for International specifications by adding 'INT' at the end of the existing Model #. For assistance on 'custom' specifications, contact zteam@zaneen.com.

In a constant effort to supply the best product, we reserve the right to change specifications or materials without notice. The most recent specification sheets are found at zaneen.com

PROJECT _____
TYPE _____
NOTES _____
QUANTITY _____
DATE _____

COMPLETE COLOR FINISH CHART

ROSA PASTEL
Pant. 1905C 281



ALEJANDRIA
Pant. 196C 261



CANET
Pant. 2717C 43



MALVA
Pant. 2567C 141



AMORATADO
Pant. 265C 135



LAPIZLAZULI
Pant. 2745C 62



VIOLETA
Pant. 7676C 147



Standard Colors with [S-]

Other fabric cord colors available upon request. Price increase and minimum quantities may apply

Digital: Not all screens are calibrated the same, and therefore, colors will appear differently between screens.

Physical: When texture is involved, there will be variations in color, character and tone within a product series and between product families.

Zaneen Group Inc. © 2024, T 1800-388-3382, F 416-247-9319, www.zaneen.com

Available for International specifications by adding 'INT' at the end of the existing Model #. For assistance on 'custom' specifications, contact zteam@zaneen.com.

In a constant effort to supply the best product, we reserve the right to change specifications or materials without notice. The most recent specification sheets are found at zaneen.com

PROJECT	
TYPE	
SPECIFIER	
QUANTITY	
DATE	

LEGEND

	floor-mounted		pivotal		special LED (upon request) RGB, RGBW, tunable, gold+, meat+, art+, fashion+
	wall and ceiling: recessed and surface mounted		rotating		warm dim / natural dimming LED
	ceiling-mounted and wall-mounted		illuminate tilted		rechargeable battery powered
	wall-mounted		color of suspension cable		fixture with natural vivid LED (upon request)
	omni-directional light distribution		length of suspension cable		color rendering index
	direct light distribution		reflector degree selection		color temperature
	direct/indirect light distribution		super spot		lumen (luminous flux)
	indirect light distribution		lens		efficacy (lumens per watt)
	asymmetric light distribution		lens pack		Unified Glare Rating (UGR) range from 5-40
	aura light distribution		shine ring		marine grade (AISI 316 stainless steel)
	round wall or ceiling cut-out		integrated shine ring with diffuser		walk on
	square wall or ceiling cut-out		free individual colors 01-29		drive on
	the supplied jig specifies the cutout dimensions		individual colors: 00 (free of charge), 01-25 (extra charge)		Dark Sky Compliance
	minimum distance (meters) lamp - object		luminaire part to be colored (F1)		Americans with Disabilities Act (less than 4" off the wall located between 27"-84" from floor)
	recessed depth		luminaire part to be colored (F2)		lamp protected against explosion
	ceiling thickness in mm		luminaire part to be colored (F3)		blown glass using traditional methods by master glass blower
	ceiling thickness selection		luminaire part to be colored (F4)		acoustic material
	dimmable DP (phase), DV (0-10V), DD (dali), DS (step-dim)		luminaire part to be colored (F5)		protection class I, protection insulation
	included or excluded LED driver/transformer/control gear		color of 3-circuit adaptor		protection class II, protection insulation
	separately switchable		indirect diffuser		ETL Certified to UL and CSA Standards
	sensor		direct diffuser		UL Certified to UL and CSA Standards
	remote control		ball-proof (upon request)		CSA Certified to UL and CSA Standards
	available upon request		accessory		Certified for North American Standards

IP RATING

	protected against ingress of solid bodies greater than 12.5mm (finger)
	protected against ingress of solid bodies greater than 2.5mm protected against sprays of water up to 60 degrees from the vertical (rain)
	protected against ingress of solid bodies greater than 1mm (wire) no protection against the ingress of moisture
	protected against ingress of solid bodies greater than 1mm (wire) protected against sprays of water up to 60 degrees from the vertical (rain)
	protected against ingress of solid bodies greater than 1mm (wire) protected against water splashed from all directions
	protected against limited ingress of dust (wet rooms/covered outdoor areas) protected against water splashed from all directions
	protected against ingress of dust protected against jets of water
	protected against ingress of dust protected against powerful jets of water or heavy seas
	protected against ingress of dust protected against immersion of water between 15cm - 1m for 30 minutes
	protected against ingress of dust protected against immersion of water under pressure for long periods

IK RATING

	protected against 0.14 joules impact (equivalent to 0.25kg mass dropped from 56mm above the surface)
	protected against 0.2 joules impact (equivalent to 0.25kg mass dropped from 80mm above the surface)
	protected against 0.35 joules impact (equivalent to 0.25kg mass dropped from 140mm above the surface)
	protected against 0.5 joules impact (equivalent to 0.25kg mass dropped from 200mm above the surface)
	protected against 0.7 joules impact (equivalent to 0.25kg mass dropped from 280mm above the surface)
	protected against 1 joules impact (equivalent to 0.25kg mass dropped from 400mm above the surface)
	protected against 2 joules impact (equivalent to 0.5kg mass dropped from 400mm above the surface)
	protected against 5 joules impact (equivalent to 1.7kg mass dropped from 300mm above the surface)
	protected against 10 joules impact (equivalent to 5.0kg mass dropped from 200mm above the surface)
	protected against 20 joules impact (equivalent to 5.0kg mass dropped from 400mm above the surface)