

PAGODA SUSPENSION

D111228-

base number Finish
Options

PROJECT
TYPE
SPECIFIER
QUANTITY
DATE

- To build a product code in our configurator select the specify button on the base model # product page
- To build a manual product code on this datasheet choose from the options listed below in blue font and add the suffix to the base model #

GENERAL

Series: Pagoda
 Partner: Ole
 Division: Design
 Installation: Suspension
 Product Type: Pendant
 Mounting Location: Ceiling

PHYSICAL

Shape: Hexagon
 Length (mm): 600
 Length (in): 23 5/8
 Width (mm): 520
 Width (in): 20 1/2
 Height (mm): 410
 Height (in): 16 1/8
 Max. Overall Height (mm): 2410
 Max. Overall Height (in): 94 7/8
 Weight (kg): 5.48
 Diffuser: PMMA - Opal
 Fixture Finish: BEI / BLK / BLU / COG / DGN / GRY / MRN / MOC / MUS / OLV / SIL / STN / TER / WHI
 Holder Finish: BLK
 Fixture Material: Metal / PMMA / Recycled Cord
 Primary Material: Fabric - Recycled
 Cable Details: 2000mm / 78 3/4" Transparent Cable

ELECTRICAL

Number of Lamps: 1
 Lamp Type: LED Retrofit
 Max. Wattage Per Lamp (W): 15
 Lamp Base: E27
 Dimming: Non-Dimmable
 Driver Included: No
 Input Voltage (V): 120
 Upon Request: Casambi

LED

OPTICAL

RATINGS AND CERTIFICATIONS

Certified By: Certified for North American Standards
 IP rating: IP20

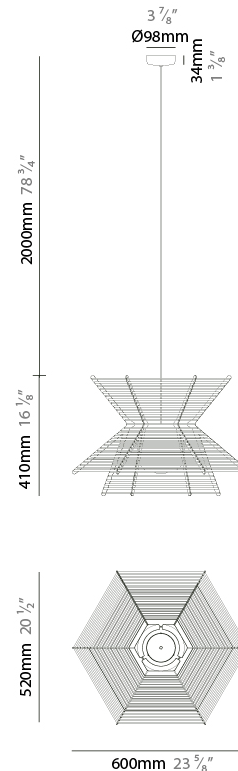

D111228-

PROJECT

TYPE

SPECIFIER

QUANTITY

DATE

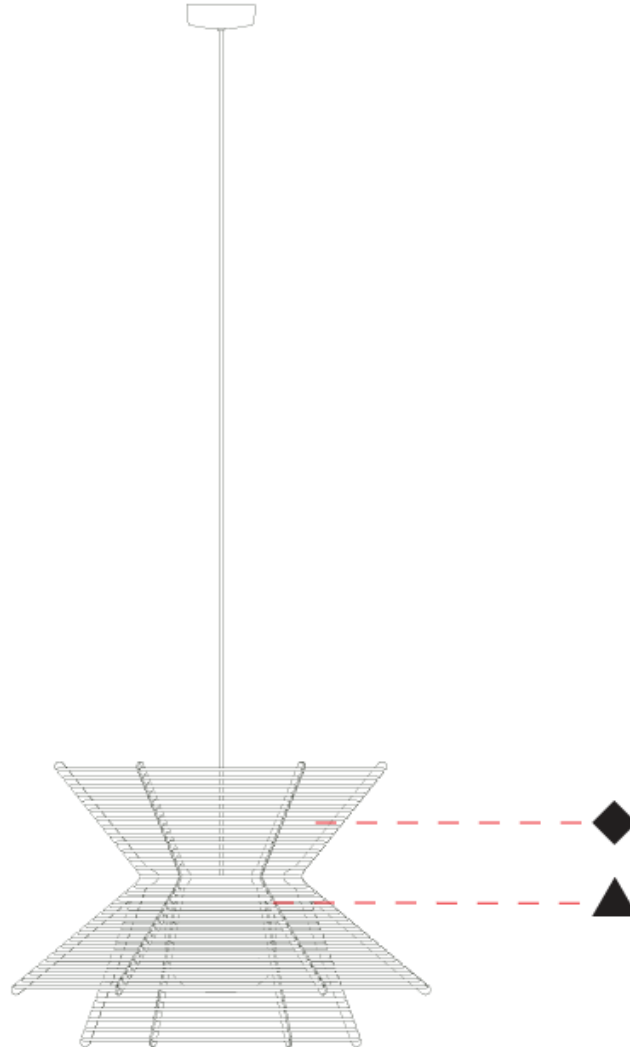

D

PAGODA SURFACE

D113077-

base number Finish
Options

PROJECT
TYPE
SPECIFIER
QUANTITY
DATE

- To build a product code in our configurator select the specify button on the base model # product page
- To build a manual product code on this datasheet choose from the options listed below in blue font and add the suffix to the base model #

GENERAL

Series: Pagoda
 Partner: Ole
 Division: Design
 Installation: Surface
 Product Type: Wall Surface
 Mounting Location: Wall
 Light Distribution: Direct / Indirect

PHYSICAL

Shape: Abstract
 Width (mm): 310
 Width (in): 12 ³/₁₆
 Height (mm): 240
 Depth (mm): 150
 Height (in): 9 ⁷/₁₆
 Depth (in): 5 ⁷/₈
 Weight (kg): 1.62
 Diffuser: PMMA - Opal
 Fixture Finish: BEI / BLK / BLU / COG / DGN / GRY / MRN / MOC / MUS / OLV / SIL / STN / TER / WHI
 Holder Finish: BLK
 Fixture Material: Metal / PMMA / Recycled Cord

ELECTRICAL

Number of Lamps: 1
 Lamp Type: LED Retrofit
 Max. Wattage Per Lamp (W): 7
 Lamp Base: G9
 Dimming: Non-Dimmable
 Driver Included: No
 Input Voltage (V): 120
 Upon Request: Casambi

LED

OPTICAL

RATINGS AND CERTIFICATIONS

Certified By: Certified for North American Standards
 IP rating: IP20

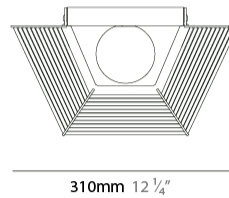
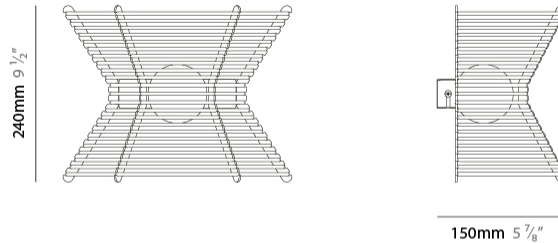
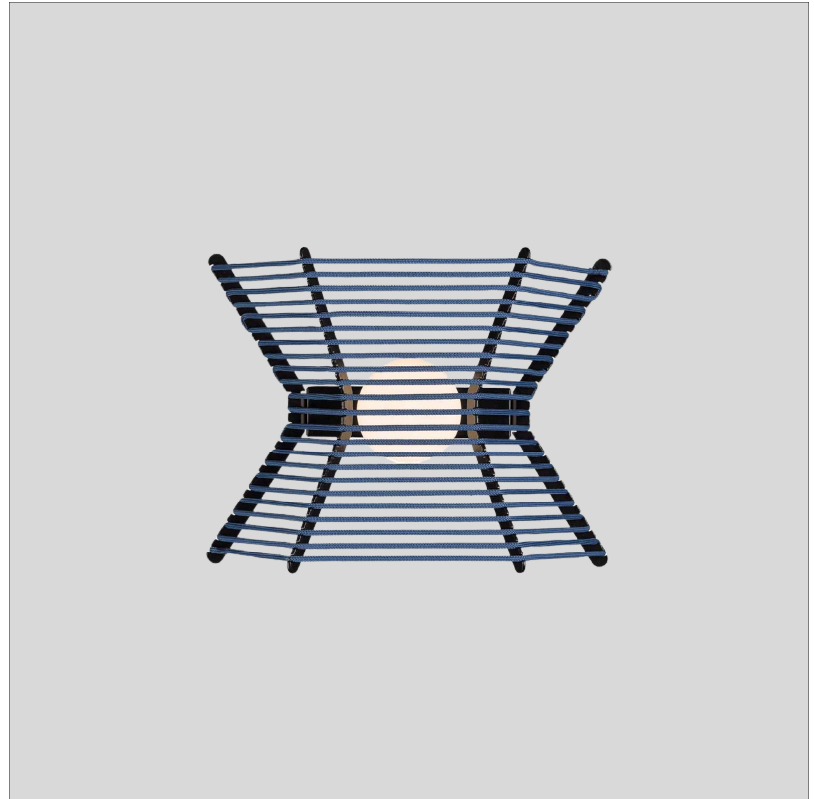

PAGODA SURFACE

D113077-

PROJECT

TYPE

SPECIFIER

QUANTITY

DATE

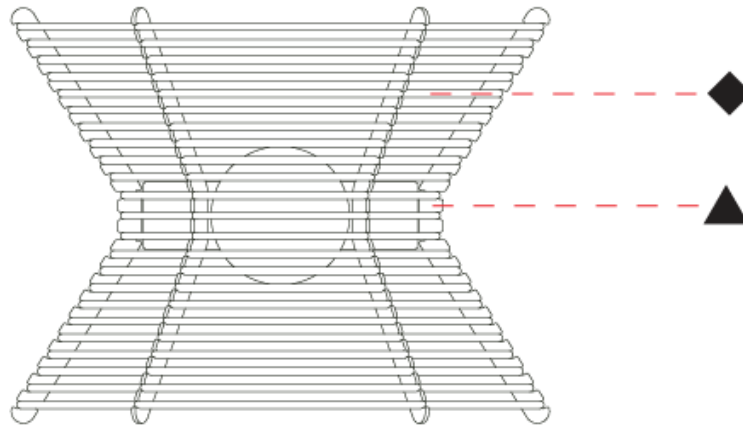

D

PAGODA PORTABLE

D114045-

base number Finish
Options

PROJECT
TYPE
SPECIFIER
QUANTITY
DATE

- To build a product code in our configurator select the specify button on the base model # product page
- To build a manual product code on this datasheet choose from the options listed below in blue font and add the suffix to the base model #

GENERAL

Series: Pagoda
 Partner: Ole
 Division: Design
 Installation: Portable
 Product Type: Floor
 Mounting Location: Floor

PHYSICAL

Shape: Hexagon
 Length (mm): 600
 Length (in): 23 5/8
 Width (mm): 520
 Width (in): 20 1/2
 Height (mm): 1600
 Height (in): 63
 Weight (kg): 8.74
 Diffuser: PMMA - Opal
 Fixture Finish: BEI / BLK / BLU / COG / DGN / GRY / MRN / MOC / MUS / OLV / SIL / STN / TER / WHI
 Holder Finish: BLK
 Fixture Material: Metal / PMMA / Recycled Cord

ELECTRICAL

Number of Lamps: 1
 Lamp Type: LED Retrofit
 Max. Wattage Per Lamp (W): 15
 Lamp Base: E27
 Dimming: Non-Dimmable
 Driver Included: No
 Input Voltage (V): 120

LED

OPTICAL

RATINGS AND CERTIFICATIONS

Certified By: Certified for North American Standards
 IP rating: IP20

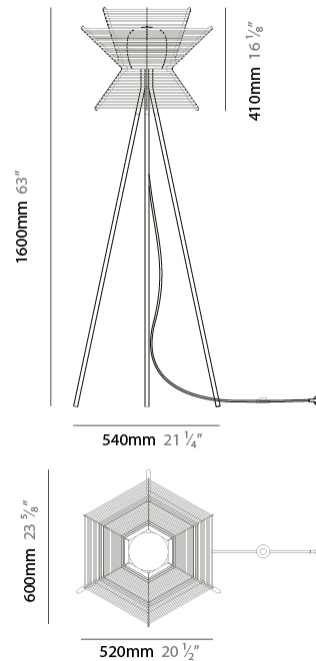

PAGODA PORTABLE

D114045-

PROJECT
TYPE
SPECIFIER
QUANTITY
DATE

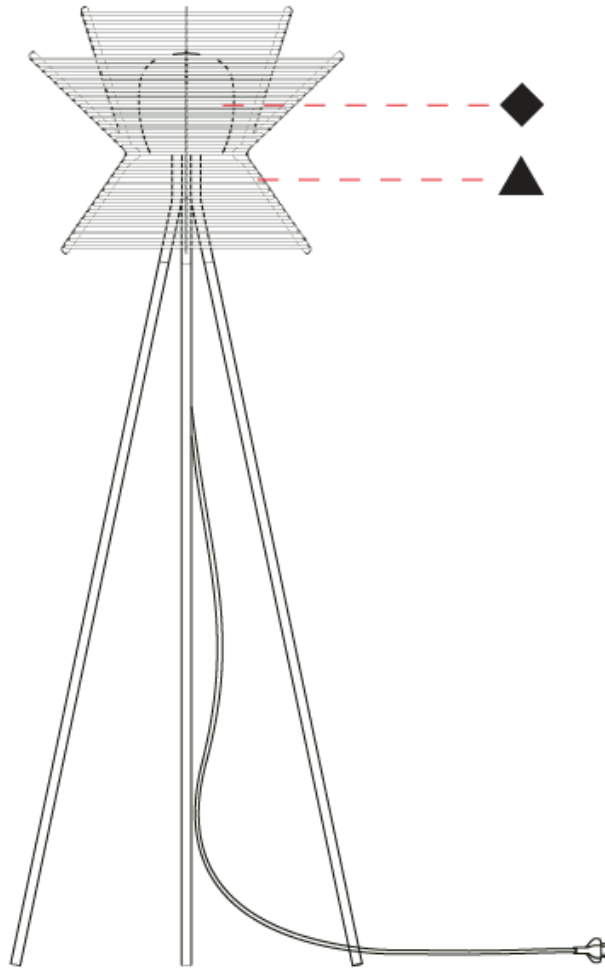

D

PAGODA

COLOR FINISH CHART

PROJECT _____

TYPE _____

SPECIFIER _____

QUANTITY _____

DATE _____

Fixture Finish

Beige - BEI



Black - BLK



Blue - BLU



Cognac - COG



Dark Green - DGN



Gray - GRY



Maroon - MRN



Mocha - MOC



Mustard - MUS



Olive - OLV



Silver - SIL



Stone - STN



Terracotta - TER



White - WHI

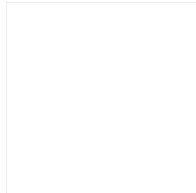

Holder Finish

Black - BLK



Digital: Not all screens are calibrated the same, and therefore, colors will appear differently between screens.

Physical: When texture is involved, there will be variations in color, character and tone within a product series and between product families.



COMPLETE COLOR FINISH CHART

Standard Colors of Recycles Cords

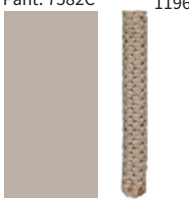
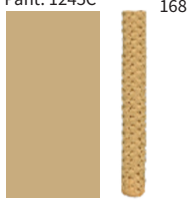
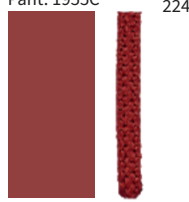
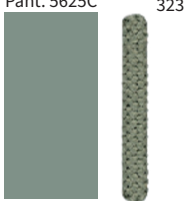
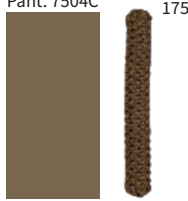
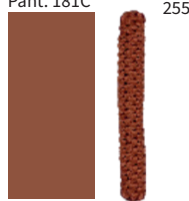
<p>STONE Pant. 7582C</p>  <p>1196</p>	<p>BEIGE Pant. 727C</p>  <p>196</p>	<p>MUSTARD Pant. 1245C</p>  <p>168</p>	<p>TERRACOTTA Pant. 153C</p>  <p>205</p>	<p>MAROON Pant. 1955C</p>  <p>224</p>
<p>WHITE Pant. White</p>  <p>71</p>	<p>OLIVE Pant. 5625C</p>  <p>323</p>	<p>DARK GREEN Pant. 5615C</p>  <p>301</p>	<p>MOCHA Pant. 7504C</p>  <p>175</p>	<p>COGNAC Pant. 181C</p>  <p>255</p>
<p>BLUE Pant. 663C</p>  <p>61</p>	<p>SILVER Pant. Cool Gray 7C</p>  <p>129</p>	<p>GREY Pant. Cool Gray 10C</p>  <p>120</p>	<p>BLACK Pant. Black C</p>  <p>211</p>	

Sustainable Thin Cord



Standard Colors with [S-]

Other fabric cord colors available upon request. Price increase and minimum quantities may apply

Digital: Not all screens are calibrated the same, and therefore, colors will appear differently between screens.

Physical: When texture is involved, there will be variations in color, character and tone within a product series and between product families.

Zaneen Group Inc. © 2024, T 1800-388-3382, F 416-247-9319, www.zaneen.com

Available for International specifications by adding 'INT' at the end of the existing Model #. For assistance on 'custom' specifications, contact zteam@zaneen.com.

In a constant effort to supply the best product, we reserve the right to change specifications or materials without notice. The most recent specification sheets are found at zaneen.com

COMPLETE COLOR FINISH CHART

Special Colors (for indoor use only)

<p>CRISTAL Pant. Glass 75</p> 	<p>Crudo Pant. 7401C 170</p> 	<p>ORO Pant. 872C 16</p> 	<p>GOLDEN Pant. 7403C 7</p> 	<p>AVELLANA Pant. 1955C 152</p> 
<p>ALPACA Pant. 429C 1401</p> 	<p>ARENA Pant. 465C 151</p> 	<p>CASTOR Pant. P7530C 167</p> 	<p>TABACO Pant. 1545C 203</p> 	<p>MARRON Pant. 476C 187</p> 
<p>TUNEL Pant. Black 7C 169</p> 	<p>BURDEOS Pant. 188C 163</p> 	<p>FRESILLA Pant. 695C 273</p> 	<p>ARCILLA Pant. 1675C 205</p> 	<p>SATAN Pant. 207C 19</p> 
<p>MUSGO Pant. 5535C 320</p> 	<p>NOCTURNO Pant. 7547 66</p> 	<p>MEDAS Pant. 295C 168</p> 	<p>LAVA Pant. 151C 1334</p> 	<p>FUEGO Pant. 185C 245</p> 
<p>VERDE OSCURO Pant. 3298C 358</p> 	<p>MARINO Pant. 289C 63</p> 	<p>AZUL ELECTRICO Pant. 2945C 168</p> 	<p>CALABAZA Pant. 158C 84</p> 	<p>ROJO Pant. 186C 241</p> 
<p>JUNGLA Pant. 356C 310</p> 	<p>AZUL ROYAL Pant. 288C 1075</p> 	<p>VIOLETA Pant. 7676U 147</p> 	<p>AMARILLO Pant. 109U 1</p> 	<p>CICLAMOR Pant. 205C 264</p> 

Standard Colors with [S-]

Other fabric cord colors available upon request. Price increase and minimum quantities may apply

Digital: Not all screens are calibrated the same, and therefore, colors will appear differently between screens.

Physical: When texture is involved, there will be variations in color, character and tone within a product series and between product families.

Zaneen Group Inc. © 2024, T 1800-388-3382, F 416-247-9319, www.zaneen.com

Available for International specifications by adding 'INT' at the end of the existing Model #. For assistance on 'custom' specifications, contact zteam@zaneen.com.

In a constant effort to supply the best product, we reserve the right to change specifications or materials without notice. The most recent specification sheets are found at zaneen.com

LEGEND

	floor-mounted		pivotal		special LED (upon request) RGB, RGBW, tunable, gold+, meat+, art+, fashion+
	wall and ceiling: recessed and surface mounted		rotating		warm dim / natural dimming LED
	ceiling-mounted and wall-mounted		illuminate tilted		rechargeable battery powered
	wall-mounted		color of suspension cable		fixture with natural vivid LED (upon request)
	omni-directional light distribution		length of suspension cable		color rendering index
	direct light distribution		reflector degree selection		color temperature
	direct/indirect light distribution		super spot		lumen (luminous flux)
	indirect light distribution		lens		efficacy (lumens per watt)
	asymmetric light distribution		lens pack		Unified Glare Rating (UGR) range from 5-40
	aura light distribution		shine ring		marine grade (AISI 316 stainless steel)
	round wall or ceiling cut-out		integrated shine ring with diffuser		walk on
	square wall or ceiling cut-out		free individual colors 01-29		drive on
	the supplied jig specifies the cutout dimensions		individual colors: 00 (free of charge), 01-25 (extra charge)		Dark Sky Compliance
	minimum distance (meters) lamp - object		luminaire part to be colored (F1)		Americans with Disabilities Act (less than 4" off the wall located between 27"-84" from floor)
	recessed depth		luminaire part to be colored (F2)		lamp protected against explosion
	ceiling thickness in mm		luminaire part to be colored (F3)		blown glass using traditional methods by master glass blower
	ceiling thickness selection		luminaire part to be colored (F4)		acoustic material
	dimnable DP (phase), DV (0-10V), DD (dali), DS (step-dim)		luminaire part to be colored (F5)		protection class I, protection insulation
	included or excluded LED driver/transformer/control gear		color of 3-circuit adaptor		protection class II, protection insulation
	separately switchable		indirect diffuser		ETL Certified to UL and CSA Standards
	sensor		direct diffuser		UL Certified to UL and CSA Standards
	remote control		ball-proof (upon request)		CSA Certified to UL and CSA Standards
	available upon request		accessory		Certified for North American Standards

IP RATING

	protected against ingress of solid bodies greater than 12.5mm (finger)
	protected against ingress of solid bodies greater than 2.5mm protected against sprays of water up to 60 degrees from the vertical (rain)
	protected against ingress of solid bodies greater than 1mm (wire) no protection against the ingress of moisture
	protected against ingress of solid bodies greater than 1mm (wire) protected against sprays of water up to 60 degrees from the vertical (rain)
	protected against ingress of solid bodies greater than 1mm (wire) protected against water splashed from all directions
	protected against limited ingress of dust (wet rooms/covered outdoor areas) protected against water splashed from all directions
	protected against ingress of dust protected against jets of water
	protected against ingress of dust protected against powerful jets of water or heavy seas
	protected against ingress of dust protected against immersion of water between 15cm - 1m for 30 minutes
	protected against ingress of dust protected against immersion of water under pressure for long periods

IK RATING

	protected against 0.14 joules impact (equivalent to 0.25kg mass dropped from 56mm above the surface)
	protected against 0.2 joules impact (equivalent to 0.25kg mass dropped from 80mm above the surface)
	protected against 0.35 joules impact (equivalent to 0.25kg mass dropped from 140mm above the surface)
	protected against 0.5 joules impact (equivalent to 0.25kg mass dropped from 200mm above the surface)
	protected against 0.7 joules impact (equivalent to 0.25kg mass dropped from 280mm above the surface)
	protected against 1 joules impact (equivalent to 0.25kg mass dropped from 400mm above the surface)
	protected against 2 joules impact (equivalent to 0.5kg mass dropped from 400mm above the surface)
	protected against 5 joules impact (equivalent to 1.7kg mass dropped from 300mm above the surface)
	protected against 10 joules impact (equivalent to 5.0kg mass dropped from 200mm above the surface)
	protected against 20 joules impact (equivalent to 5.0kg mass dropped from 400mm above the surface)