

|           |
|-----------|
| PROJECT   |
| TYPE      |
| SPECIFIER |
| QUANTITY  |
| DATE      |

## PIT - MONOPOINT SUSPENSION

### D141180-

base number      Finish Options      -      Finish Options

- To build a product code in our configurator select the specify button on the base model # product page
- To build a manual product code on this datasheet choose from the options listed below in blue font and add the suffix to the base model #

#### GENERAL

Series: Pit  
 Subseries: Pit - Monopoint  
 Brand: Cangini & Tucci  
 Division: Design  
 Mounting Type: Suspension  
 Mounting Location: Ceiling  
 Subcategory: Pendant

#### PHYSICAL

Shape: Sphere  
 Diameter (mm): 220  
 Diameter (in): 8 11/16  
 Height (mm): 220  
 Height (in): 8 11/16  
 Max. Overall Height (mm): 2220  
 Max. Overall Height (in): 87 3/8  
 Light Distribution: Omnidirectional  
 Weight (kg): 0.750  
 Weight (lbs): 1.65  
 Fixture Finish: [AMB / GRN / PNK / RUB / SKB / SMK / TOB / TRA](#)  
 Holder Finish: CHR / WHI / BLK / BCR  
 Fixture Material: Glass / Metal  
 Cable Details: 2000mm / 78 3/4" - Transparent Cable  
 Upon Request: On Demand Holder Finishes - Satin Gold, Satin Bronze or Satin Black Nickel

#### ELECTRICAL

Lamp Type: LED  
 Input Wattage (W): 7.8  
 Total Output Wattage (W): 6  
 Dimming: Non-Dimmable  
 Driver Included: Yes  
 Driver Location: Integrated  
 Input Voltage (V): 120  
 Constant Current (MA): 500mA  
 Upon Request: Phase Dimming (120Vac only) / 0-10V Dimming

#### LED

Color Temperature (°K): 3000  
 Max. Delivered Lumen (lm): 864  
 Nominal Lumen (lm): 886  
 CRI: >90 CRI

#### OPTICAL

#### RATINGS AND CERTIFICATIONS

Certified By: Certified for North American Standards  
 IP rating: IP20

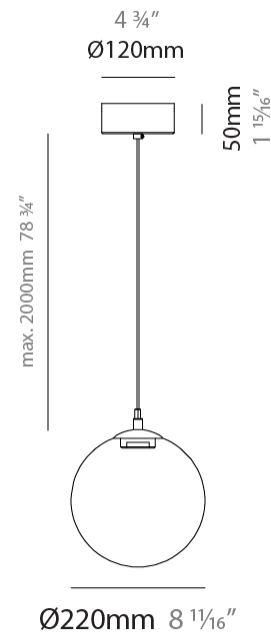

## PIT - MONOPOINT SUSPENSION

D141180-

PROJECT

TYPE

SPECIFIER

QUANTITY

DATE

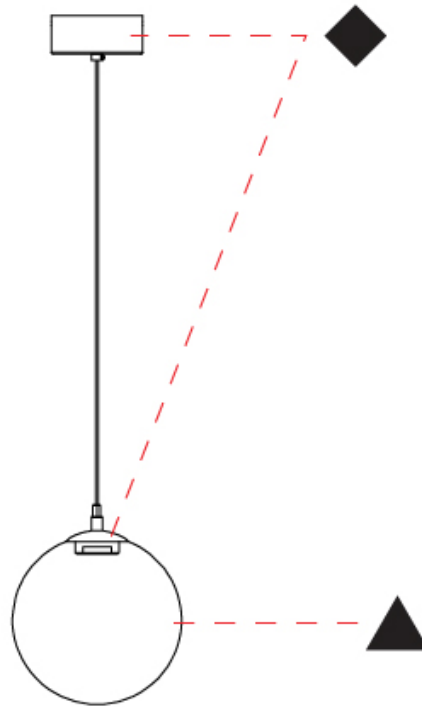

D

|           |
|-----------|
| PROJECT   |
| TYPE      |
| SPECIFIER |
| QUANTITY  |
| DATE      |

## PIT - MONOPOINT SUSPENSION

### D141181-

base number      Finish Options      Finish Options

- To build a product code in our configurator select the specify button on the base model # product page
- To build a manual product code on this datasheet choose from the options listed below in blue font and add the suffix to the base model #

#### GENERAL

Series: Pit  
 Subseries: Pit - Monopoint  
 Brand: Cangini & Tucci  
 Division: Design  
 Mounting Type: Suspension  
 Mounting Location: Ceiling  
 Subcategory: Pendant

#### PHYSICAL

Shape: Sphere  
 Diameter (mm): 260  
 Diameter (in): 10 1/4  
 Height (mm): 260  
 Height (in): 10 1/4  
 Max. Overall Height (mm): 2260  
 Max. Overall Height (in): 89  
 Light Distribution: Omnidirectional  
 Weight (kg): 0.900  
 Weight (lbs): 1.98  
 Fixture Finish: [AMB / GRN / PNK / RUB / SKB / SMK / TOB / TRA](#)  
 Holder Finish: CHR / WHI / BLK / BCR  
 Fixture Material: Glass / Metal  
 Cable Details: 2000mm / 78 3/4" - Transparent Cable  
 Upon Request: On Demand Holder Finishes - Satin Gold, Satin Bronze or Satin Black Nickel

#### ELECTRICAL

Lamp Type: LED  
 Input Wattage (W): 7.8  
 Total Output Wattage (W): 6  
 Dimming: Non-Dimmable  
 Driver Included: Yes  
 Driver Location: Integrated  
 Input Voltage (V): 120  
 Constant Current (MA): 500mA  
 Upon Request: Phase Dimming (120Vac only) / 0-10V Dimming

#### LED

Color Temperature (°K): 3000  
 Max. Delivered Lumen (lm): 866  
 Nominal Lumen (lm): 886  
 CRI: >90 CRI

#### OPTICAL

#### RATINGS AND CERTIFICATIONS

Certified By: Certified for North American Standards  
 IP rating: IP20

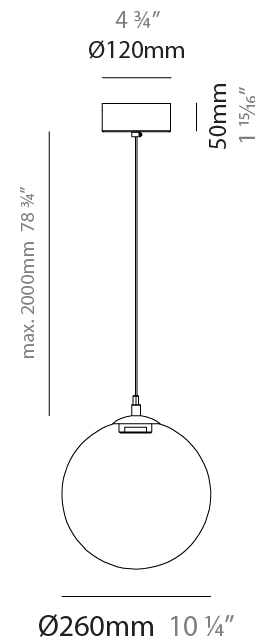

## PIT - MONOPOINT SUSPENSION

D141181-

|           |       |
|-----------|-------|
| PROJECT   | _____ |
| TYPE      | _____ |
| SPECIFIER | _____ |
| QUANTITY  | _____ |
| DATE      | _____ |

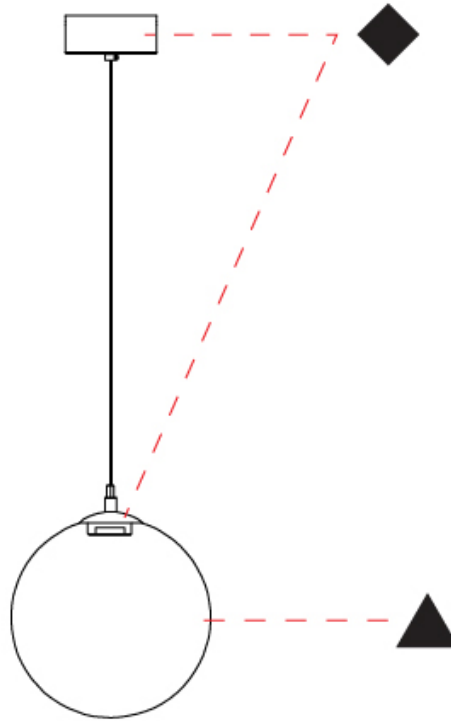

D

|           |  |
|-----------|--|
| PROJECT   |  |
| TYPE      |  |
| SPECIFIER |  |
| QUANTITY  |  |
| DATE      |  |

## PIT - MONOPOINT SUSPENSION

### D141182-

base number      Finish      Finish  
Options            Options

- To build a product code in our configurator select the specify button on the base model # product page
- To build a manual product code on this datasheet choose from the options listed below in blue font and add the suffix to the base model #

#### GENERAL

Series: Pit  
 Subseries: Pit - Monopoint  
 Brand: Cangini & Tucci  
 Division: Design  
 Mounting Type: Suspension  
 Mounting Location: Ceiling  
 Subcategory: Pendant

#### PHYSICAL

Shape: Sphere  
 Diameter (mm): 300  
 Diameter (in): 11 <sup>13</sup>/<sub>16</sub>  
 Height (mm): 300  
 Height (in): 11 <sup>13</sup>/<sub>16</sub>  
 Max. Overall Height (mm): 2300  
 Max. Overall Height (in): 90 <sup>9</sup>/<sub>16</sub>  
 Light Distribution: Omnidirectional  
 Weight (kg): 1.100  
 Weight (lbs): 2.43  
 Fixture Finish: [AMB / GRN / PNK / RUB / SKB / SMK / TOB / TRA](#)  
 Holder Finish: CHR / WHI / BLK / BCR  
 Fixture Material: Glass / Metal  
 Cable Details: 2000mm / 78 3/4" - Transparent Cable  
 Upon Request: On Demand Holder Finishes - Satin Gold, Satin Bronze or Satin Black Nickel

#### ELECTRICAL

Lamp Type: LED  
 Input Wattage (W): 7.8  
 Total Output Wattage (W): 6  
 Dimming: Non-Dimmable  
 Driver Included: Yes  
 Driver Location: Integrated  
 Input Voltage (V): 120  
 Constant Current (MA): 500mA  
 Upon Request: Phase Dimming (120Vac only) / 0-10V Dimming

#### LED

Color Temperature (°K): 3000  
 Max. Delivered Lumen (lm): 866  
 Nominal Lumen (lm): 886  
 CRI: >90 CRI

#### OPTICAL

#### RATINGS AND CERTIFICATIONS

Certified By: Certified for North American Standards  
 IP rating: IP20

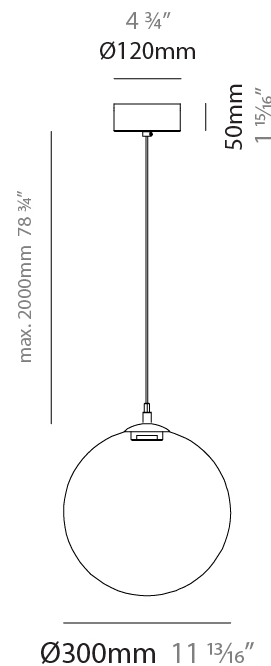

## PIT - MONOPOINT SUSPENSION

D141182-

PROJECT

TYPE

SPECIFIER

QUANTITY

DATE

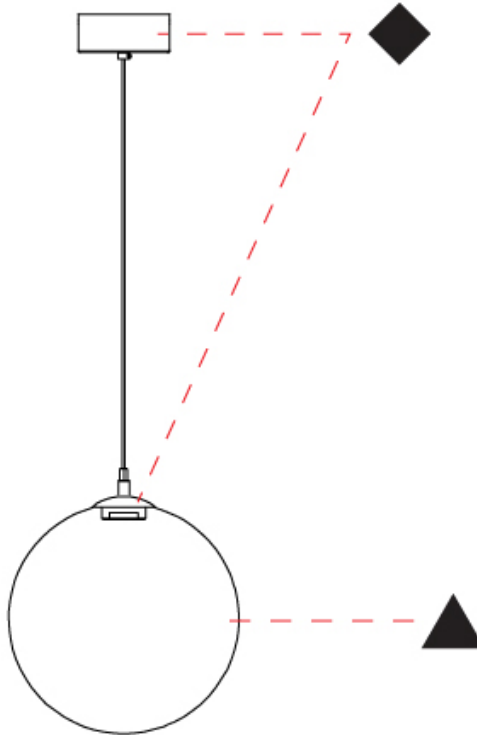

D

|           |
|-----------|
| PROJECT   |
| TYPE      |
| SPECIFIER |
| QUANTITY  |
| DATE      |

## PIT - MONOPOINT SUSPENSION

### D141183-

base number      Finish      Finish  
Options            Options

- To build a product code in our configurator select the specify button on the base model # product page
- To build a manual product code on this datasheet choose from the options listed below in blue font and add the suffix to the base model #

#### GENERAL

Series: Pit  
 Subseries: Pit - Monopoint  
 Brand: Cangini & Tucci  
 Division: Design  
 Mounting Type: Suspension  
 Mounting Location: Ceiling  
 Subcategory: Pendant

#### PHYSICAL

Shape: Sphere  
 Diameter (mm): 360  
 Diameter (in): 14 <sup>3</sup>/<sub>16</sub>  
 Height (mm): 360  
 Height (in): 14 <sup>3</sup>/<sub>16</sub>  
 Max. Overall Height (mm): 2360  
 Max. Overall Height (in): 92 <sup>15</sup>/<sub>16</sub>  
 Light Distribution: Omnidirectional  
 Weight (kg): 2.400  
 Weight (lbs): 5.29  
 Fixture Finish: [AMB / GRN / PNK / RUB / SKB / SMK / TOB / TRA](#)  
 Holder Finish: CHR / MWH / MBK / BCR  
 Fixture Material: Glass / Metal  
 Cable Details: 2000mm / 78 3/4" - Transparent Cable  
 Upon Request: On Demand Holder Finishes - Satin Gold, Satin Bronze or Satin Black Nickel

#### ELECTRICAL

Lamp Type: LED  
 Input Wattage (W): 11  
 Total Output Wattage (W): 8.4  
 Dimming: Non-Dimmable  
 Driver Included: Yes  
 Driver Location: Integrated  
 Input Voltage (V): 120  
 Constant Current (MA): 350mA  
 Upon Request: Phase Dimming (120Vac only) / 0-10V Dimming

#### LED

Color Temperature (°K): 3000  
 Max. Delivered Lumen (lm): 1200  
 CRI: >90 CRI

#### OPTICAL

#### RATINGS AND CERTIFICATIONS

Certified By: Certified for North American Standards  
 IP rating: IP20

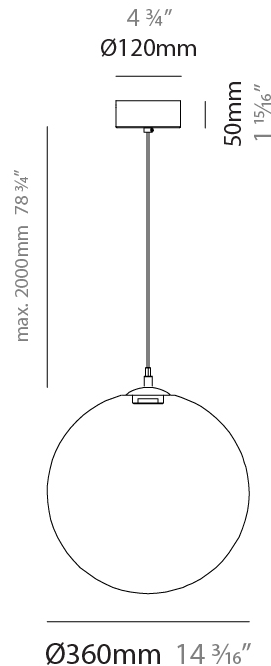

## PIT - MONOPOINT SUSPENSION

D141183-

PROJECT \_\_\_\_\_

TYPE \_\_\_\_\_

SPECIFIER \_\_\_\_\_

QUANTITY \_\_\_\_\_

DATE \_\_\_\_\_

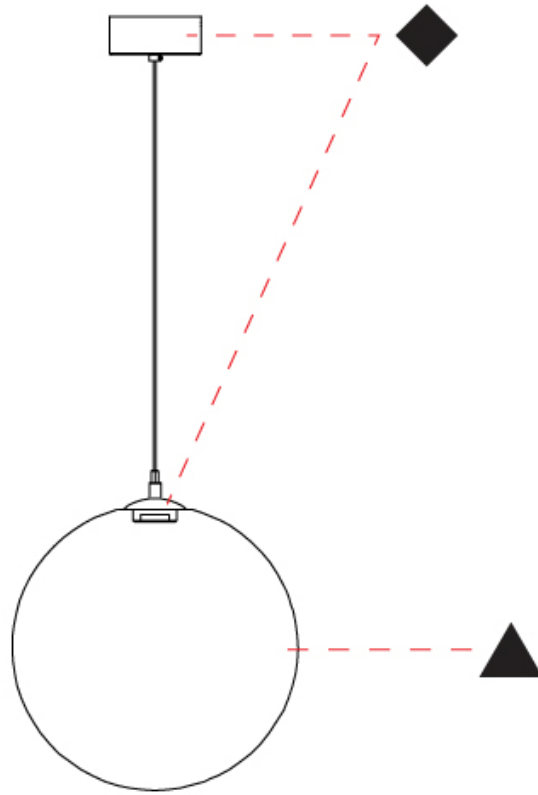

D



|           |  |
|-----------|--|
| PROJECT   |  |
| TYPE      |  |
| SPECIFIER |  |
| QUANTITY  |  |
| DATE      |  |

## PIT - SUSPENSION 3 LIGHT ROUND SUSPENSION

### D141213-

base number      Finish Options      Finish Options

- To build a product code in our configurator select the specify button on the base model # product page
- To build a manual product code on this datasheet choose from the options listed below in blue font and add the suffix to the base model #

#### GENERAL

Series: Pit  
 Subseries: Pit - Suspension 3 Light Round  
 Brand: Cangini & Tucci  
 Division: Design  
 Mounting Type: Suspension  
 Mounting Location: Ceiling  
 Subcategory: Pendant

#### PHYSICAL

Shape: Sphere  
 Diameter (mm): 520  
 Diameter (in): 20 1/2  
 Height (mm): 520  
 Height (in): 20 1/2  
 Max. Overall Height (mm): 2520  
 Max. Overall Height (in): 99 3/16  
 Light Distribution: Omnidirectional  
 Weight (kg): 4.800  
 Weight (lbs): 10.58  
 Fixture Finish: [AMB / GRN / PNK / RUB / SKB / SMK / TOB / TRA](#)  
 Holder Finish: CHR / MWH / MBK / BCR  
 Fixture Material: Glass / Metal  
 Cable Details: 2000mm / 78 3/4" - Transparent Cable  
 Upon Request: On Demand Holder Finishes - Satin Gold, Satin Bronze or Satin Black Nickel

#### ELECTRICAL

Lamp Type: LED  
 Input Wattage (W): 23.4  
 Total Output Wattage (W): 18  
 Dimming: Non-Dimmable  
 Driver Included: Yes  
 Driver Location: Integrated  
 Input Voltage (V): 120  
 Constant Current (MA): 500mA  
 Upon Request: Phase Dimming (120Vac only) / 0-10V Dimming

#### LED

Color Temperature (°K): 3000  
 Max. Delivered Lumen (lm): 2598  
 CRI: >90 CRI

#### OPTICAL

#### RATINGS AND CERTIFICATIONS

Certified By: Certified for North American Standards  
 IP rating: IP20

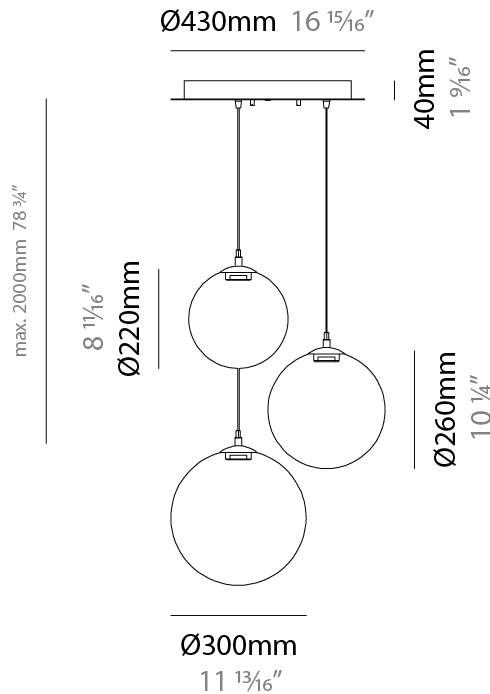

|           |       |
|-----------|-------|
| PROJECT   | _____ |
| TYPE      | _____ |
| SPECIFIER | _____ |
| QUANTITY  | _____ |
| DATE      | _____ |

## PIT - SUSPENSION 3 LIGHT ROUND SUSPENSION

D141213-

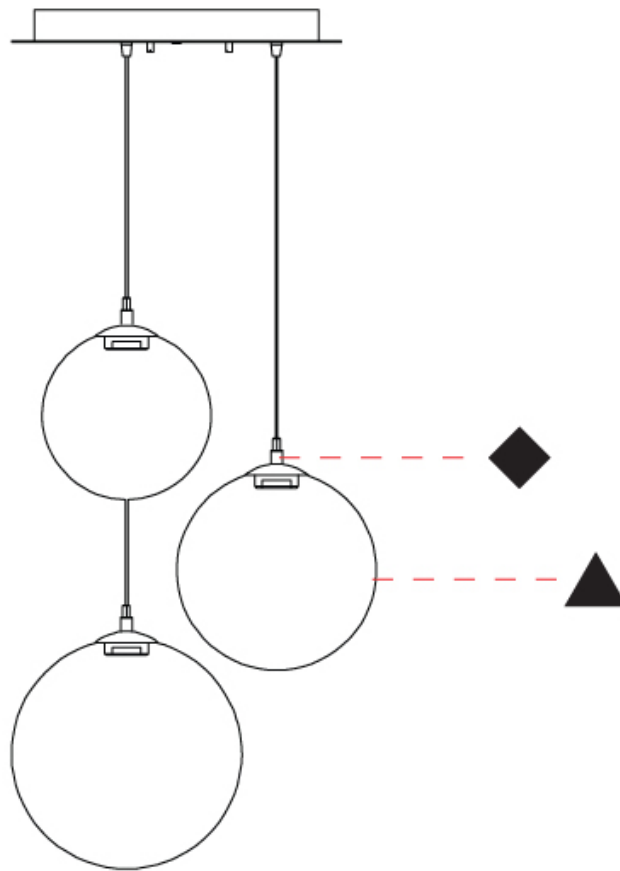

D

|           |       |
|-----------|-------|
| PROJECT   | _____ |
| TYPE      | _____ |
| SPECIFIER | _____ |
| QUANTITY  | _____ |
| DATE      | _____ |

## PIT - 3 LIGHT LINEAR SUSPENSION

### D141214- \_\_\_\_\_

base number      Finish Options      Finish Options

- To build a product code in our configurator select the specify button on the base model # product page
- To build a manual product code on this datasheet choose from the options listed below in blue font and add the suffix to the base model #

#### GENERAL

Series: Pit  
 Subseries: Pit - 3 Light Linear  
 Brand: Cangini & Tucci  
 Division: Design  
 Mounting Type: Suspension  
 Mounting Location: Ceiling  
 Subcategory: Pendant

#### PHYSICAL

Shape: Sphere  
 Diameter (mm): 220  
 Diameter (in): 8 <sup>11</sup>/<sub>16</sub>  
 Length (mm): 1200  
 Height (mm): 220  
 Height (in): 8 <sup>11</sup>/<sub>16</sub>  
 Max. Overall Height (mm): 2220  
 Max. Overall Height (in): 87 <sup>9</sup>/<sub>16</sub>  
 Light Distribution: Omnidirectional  
 Weight (kg): 3.500  
 Weight (lbs): 7.72  
 Fixture Finish: [AMB / GRN / PNK / RUB / SKB / SMK / TOB / TRA](#)  
 Holder Finish: PSS  
 Accent Finish: [CHR / MWH / MBK / BCR](#)  
 Fixture Material: Glass / Metal  
 Cable Details: 2000mm / 78 3/4" - Transparent Cable  
 Upon Request: On Demand Holder Finishes - Satin Gold, Satin Bronze or Satin Black Nickel

#### ELECTRICAL

Lamp Type: LED  
 Input Wattage (W): 23.4  
 Total Output Wattage (W): 18  
 Dimming: Non-Dimmable  
 Driver Included: Yes  
 Driver Location: Integrated  
 Input Voltage (V): 120  
 Constant Current (MA): 500mA  
 Upon Request: Phase Dimming (120Vac only) / 0-10V Dimming

#### LED

Color Temperature (°K): 3000  
 Max. Delivered Lumen (lm): 2598  
 CRI: >90 CRI

#### OPTICAL

#### RATINGS AND CERTIFICATIONS

Certified By: Certified for North American Standards  
 IP rating: IP20

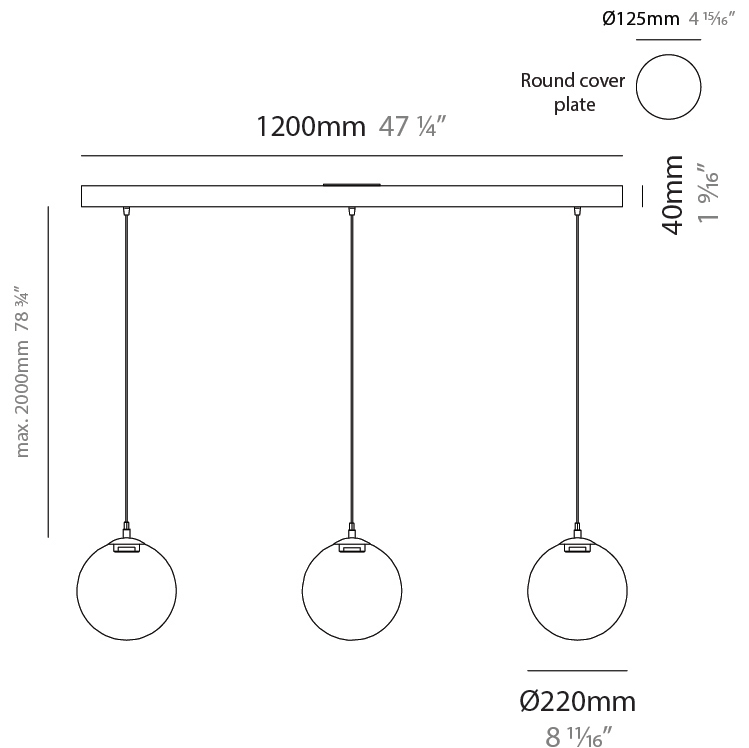

## PIT - 3 LIGHT LINEAR SUSPENSION

D141214-

|           |       |
|-----------|-------|
| PROJECT   | _____ |
| TYPE      | _____ |
| SPECIFIER | _____ |
| QUANTITY  | _____ |
| DATE      | _____ |

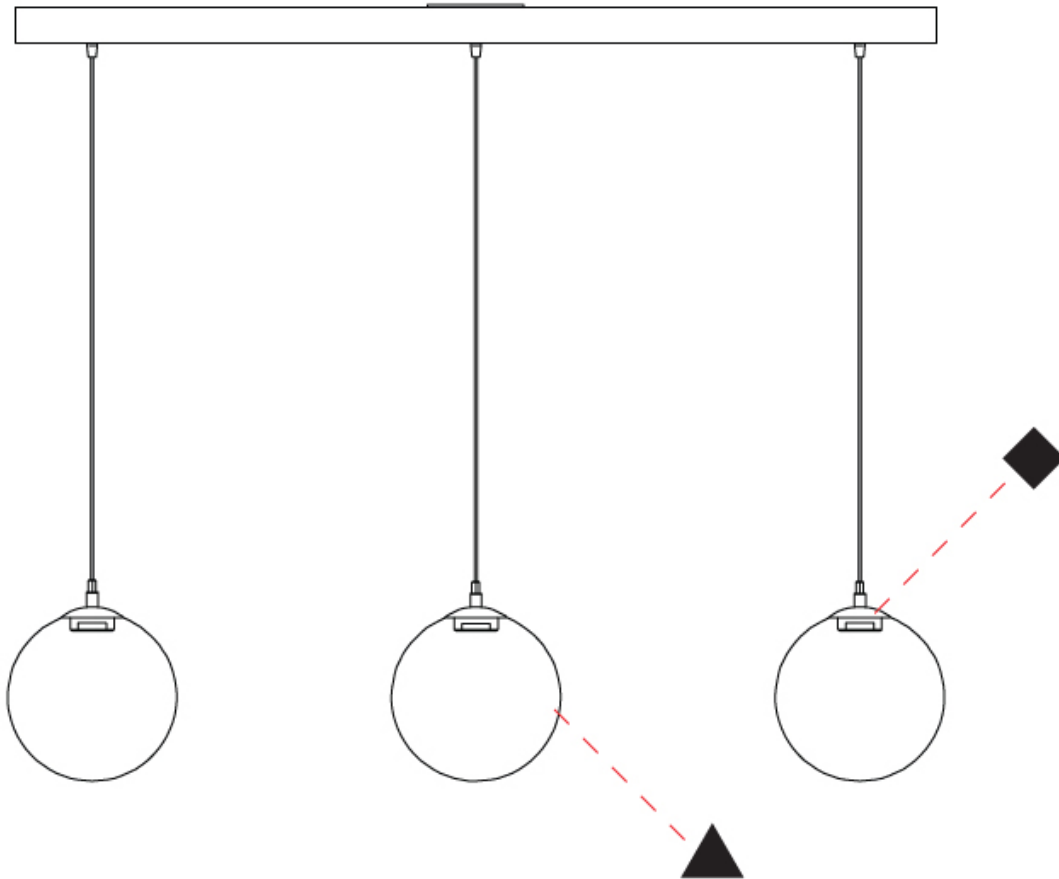

D

|           |
|-----------|
| PROJECT   |
| TYPE      |
| SPECIFIER |
| QUANTITY  |
| DATE      |

## PIT PORTABLE

### D144036-

base number      Color      Finish      Finish  
 Temperature      Options      Options

- To build a product code in our configurator select the specify button on the base model # product page
- To build a manual product code on this datasheet choose from the options listed below in blue font and add the suffix to the base model #

#### GENERAL

Series: Pit  
 Brand: Cangini & Tucci  
 Division: Design  
 Mounting Type: Portable  
 Mounting Location: Table  
 Subcategory: Table

#### PHYSICAL

Shape: Sphere  
 Diameter (mm): 220  
 Diameter (in): 8 11/16  
 Height (mm): 500  
 Height (in): 19 11/16  
 Light Distribution: Omnidirectional  
 Weight (kg): 1.8  
 Fixture Finish: [AMB](#) / [GRN](#) / [PNK](#) / [RUB](#) / [SKB](#) / [SMK](#) / [TOB](#) / [TRA](#)  
 Holder Finish: [SGD](#) / [SRG](#) / [SBN](#)  
 Fixture Material: Glass / Metal  
 Cable Details: 2000mm / 78 3/4" - Transparent Cable

#### ELECTRICAL

Lamp Type: LED  
 Input Wattage (W): 6  
 Dimming: Non-Dimmable  
 Driver Included: Yes  
 Driver Location: Integrated  
 Driver Type: Constant Current - Universal  
 Driver Class: Class 2  
 Input Voltage (V): 120 - 277  
 Constant Current (MA): 500

#### LED

Color Temperature (°K): [2700](#) / [3000](#)  
 Max. Delivered Lumen (lm): 144  
 Nominal Lumen (lm): 866  
 CRI: >90 CRI  
 Lamp Life (hrs): 50000

#### OPTICAL

#### RATINGS AND CERTIFICATIONS

Certified By: Certified for North American Standards  
 IP rating: IP20

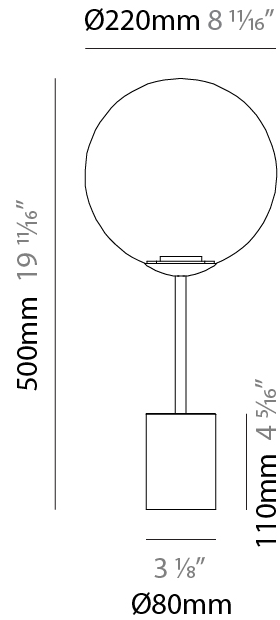

## PIT PORTABLE

D144036-

PROJECT

TYPE

SPECIFIER

QUANTITY

DATE

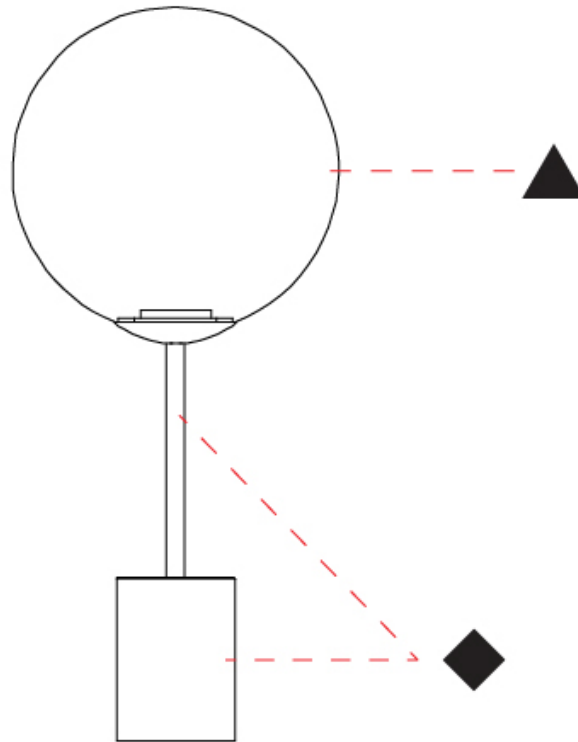

D

|           |       |
|-----------|-------|
| PROJECT   | _____ |
| TYPE      | _____ |
| SPECIFIER | _____ |
| QUANTITY  | _____ |
| DATE      | _____ |

## PIT PORTABLE

### D144037-

base number      Color      Finish      Finish  
 Temperature      Options      Options

- To build a product code in our configurator select the specify button on the base model # product page
- To build a manual product code on this datasheet choose from the options listed below in blue font and add the suffix to the base model #

#### GENERAL

Series: Pit  
 Brand: Cangini & Tucci  
 Division: Design  
 Mounting Type: Portable  
 Mounting Location: Floor  
 Subcategory: Table

#### PHYSICAL

Shape: Sphere  
 Diameter (mm): 300  
 Diameter (in): 11 13/16  
 Height (mm): 1750  
 Height (in): 68 7/8  
 Light Distribution: Omnidirectional  
 Weight (kg): 5.3  
 Fixture Finish: [AMB](#) / [GRN](#) / [PNK](#) / [RUB](#) / [SKB](#) / [SMK](#) / [TOB](#) / [TRA](#)  
 Holder Finish: [SGD](#) / [SRG](#) / [SBN](#)  
 Fixture Material: Glass / Metal  
 Cable Details: 2000mm / 78 3/4" - Transparent Cable

#### ELECTRICAL

Lamp Type: LED  
 Input Wattage (W): 8.4  
 Dimming: Non-Dimmable  
 Driver Included: Yes  
 Driver Location: Integrated  
 Driver Type: Constant Current - Universal  
 Driver Class: Class 2  
 Input Voltage (V): 120  
 Constant Current (MA): 700  
 Upon Request: Phase Dimming

#### LED

Color Temperature (°K): [2700](#) / [3000](#)  
 Max. Delivered Lumen (lm): 144  
 Nominal Lumen (lm): 1200  
 CRI: >90 CRI  
 Lamp Life (hrs): 50000

#### OPTICAL

#### RATINGS AND CERTIFICATIONS

Certified By: Certified for North American Standards  
 IP rating: IP20



Ø300mm 11 13/16"

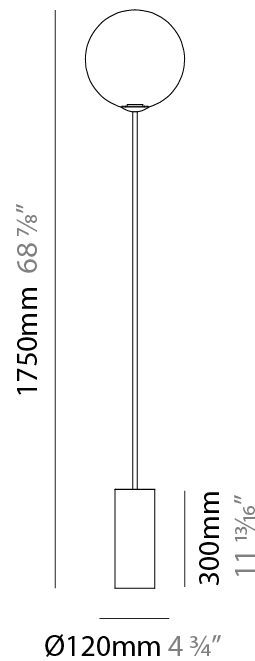

## PIT PORTABLE

D144037-

PROJECT \_\_\_\_\_

TYPE \_\_\_\_\_

SPECIFIER \_\_\_\_\_

QUANTITY \_\_\_\_\_

DATE \_\_\_\_\_

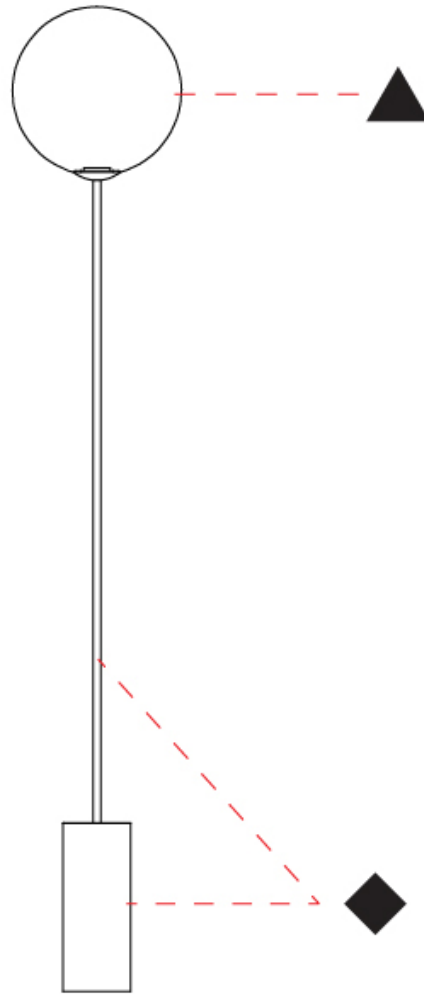

D



## PIT

### COLOR FINISH CHART

#### Fixture Finish

Amber - AMB



Green - GRN



Pink - PNK



Ruby - RUB



Sky Blue - SKB



Smoke - SMK



Tobacco - TOB



Transparent - TRA



#### Holder Finish

Chrome - CHR



White - WHI

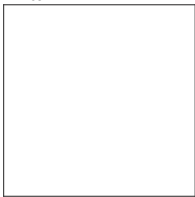

Black - BLK



Brushed Chrome - BCR



Matte White - MWH

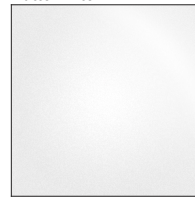

Matte Black - MBK

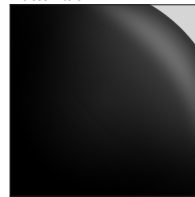

Polished Stainless Steel - PSS



Satin Gold - SGD

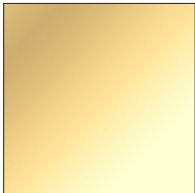

Satin Rose Gold - SRG

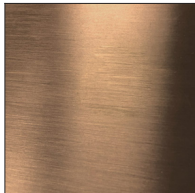

Satin Black Nickel - SBN

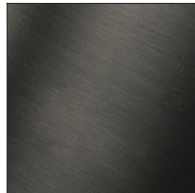

## PIT - MONOPOINT, PIT - SUSPENSION 3 LIGHT ROUND, PIT - 3 LIGHT LINEAR SUSPENSION, PORTABLE COLOR FINISH CHART

### Accent Finish

Chrome - CHR

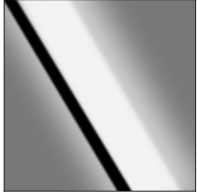

Matte White - MWH

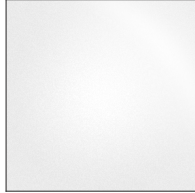

Matte Black - MBK



Brushed Chrome - BCR



**Digital:** Not all screens are calibrated the same, and therefore, colors will appear differently between screens.

**Physical:** When texture is involved, there will be variations in color, character and tone within a product series and between product families.



|           |  |
|-----------|--|
| PROJECT   |  |
| TYPE      |  |
| SPECIFIER |  |
| QUANTITY  |  |
| DATE      |  |

### LEGEND

|  |   |  |  |  |  |
|--|---|--|--|--|--|
|  | floor-mounted   |  | pivotal  |  | special LED (upon request) RGB, RGBW, tunable, gold+, meat+, art+, fashion+                    |
|  | wall and ceiling: recessed and surface mounted            |  | rotating   |  | warm dim / natural dimming LED   |
|  | ceiling-mounted and wall-mounted                          |  | illuminate tilted  |  | rechargeable battery powered   |
|  | wall-mounted  |  | color of suspension cable                                    |  | fixture with natural vivid LED (upon request)  |
|  | omni-directional light distribution                       |  | length of suspension cable                                   |  | color rendering index  |
|  | direct light distribution                                 |  | reflector degree selection                                   |  | color temperature  |
|  | direct/indirect light distribution                        |  | super spot   |  | lumen (luminous flux)  |
|  | indirect light distribution                               |  | lens   |  | efficacy (lumens per watt)   |
|  | asymmetric light distribution                             |  | lens pack  |  | Unified Glare Rating (UGR) range from 5-40   |
|  | aura light distribution                                   |  | shine ring   |  | marine grade (AISI 316 stainless steel)  |
|  | round wall or ceiling cut-out                             |  | integrated shine ring with diffuser                          |  | walk on  |
|  | square wall or ceiling cut-out                            |  | free individual colors 01-29                                 |  | drive on   |
|  | the supplied jig specifies the cutout dimensions          |  | individual colors: 00 (free of charge), 01-25 (extra charge) |  | Dark Sky Compliance  |
|  | minimum distance (meters) lamp - object                   |  | luminaire part to be colored (F1)                            |  | Americans with Disabilities Act (less than 4" off the wall located between 27"-84" from floor) |
|  | recessed depth  |  | luminaire part to be colored (F2)                            |  | lamp protected against explosion   |
|  | ceiling thickness in mm                                   |  | luminaire part to be colored (F3)                            |  | blown glass using traditional methods by master glass blower                                   |
|  | ceiling thickness selection                               |  | luminaire part to be colored (F4)                            |  | acoustic material  |
|  | dimmable DP (phase), DV (0-10V), DD (dali), DS (step-dim) |  | luminaire part to be colored (F5)                            |  | protection class I, protection insulation  |
|  | included or excluded LED driver/transformer/control gear  |  | color of 3-circuit adaptor                                   |  | protection class II, protection insulation   |
|  | separately switchable                                     |  | indirect diffuser  |  | ETL Certified to UL and CSA Standards  |
|  | sensor  |  | direct diffuser  |  | UL Certified to UL and CSA Standards   |
|  | remote control  |  | ball-proof (upon request)                                    |  | CSA Certified to UL and CSA Standards  |
|  | available upon request                                    |  | accessory  |  | Certified for North American Standards   |

### IP RATING

|  |  |
|--|--|
|  | protected against ingress of solid bodies greater than 12.5mm (finger)   |
|  | protected against ingress of solid bodies greater than 2.5mm<br>protected against sprays of water up to 60 degrees from the vertical (rain)      |
|  | protected against ingress of solid bodies greater than 1mm (wire)<br>no protection against the ingress of moisture                               |
|  | protected against ingress of solid bodies greater than 1mm (wire)<br>protected against sprays of water up to 60 degrees from the vertical (rain) |
|  | protected against ingress of solid bodies greater than 1mm (wire)<br>protected against water splashed from all directions                        |
|  | protected against limited ingress of dust (wet rooms/covered outdoor areas)<br>protected against water splashed from all directions              |
|  | protected against ingress of dust<br>protected against jets of water   |
|  | protected against ingress of dust<br>protected against powerful jets of water or heavy seas  |
|  | protected against ingress of dust<br>protected against immersion of water between 15cm - 1m for 30 minutes                                       |
|  | protected against ingress of dust<br>protected against immersion of water under pressure for long periods  |

### IK RATING

|  |   |
|--|---|
|  | protected against 0.14 joules impact (equivalent to 0.25kg mass dropped from 56mm above the surface)  |
|  | protected against 0.2 joules impact (equivalent to 0.25kg mass dropped from 80mm above the surface)   |
|  | protected against 0.35 joules impact (equivalent to 0.25kg mass dropped from 140mm above the surface) |
|  | protected against 0.5 joules impact (equivalent to 0.25kg mass dropped from 200mm above the surface)  |
|  | protected against 0.7 joules impact (equivalent to 0.25kg mass dropped from 280mm above the surface)  |
|  | protected against 1 joules impact (equivalent to 0.25kg mass dropped from 400mm above the surface)    |
|  | protected against 2 joules impact (equivalent to 0.5kg mass dropped from 400mm above the surface)     |
|  | protected against 5 joules impact (equivalent to 1.7kg mass dropped from 300mm above the surface)     |
|  | protected against 10 joules impact (equivalent to 5.0kg mass dropped from 200mm above the surface)    |
|  | protected against 20 joules impact (equivalent to 5.0kg mass dropped from 400mm above the surface)    |