

PROJECT
TYPE
SPECIFIER
QUANTITY
DATE

PIT - MONOPOINT SUSPENSION

D141180-

base number Finish Options Finish Options

- To build a product code in our configurator select the specify button on the base model # product page
- To build a manual product code on this datasheet choose from the options listed below in blue font and add the suffix to the base model #

GENERAL

Series: Pit
 Subseries: Pit - Monopoint
 Partner: Cangini & Tucci
 Division: Design
 Installation: Suspension
 Product Type: Pendant
 Mounting Location: Ceiling

PHYSICAL

Shape: Sphere
 Diameter (mm): 220
 Diameter (in): 8 11/16
 Height (mm): 220
 Height (in): 8 11/16
 Max. Overall Height (mm): 2220
 Max. Overall Height (in): 87 3/8
 Weight (kg): 0.750
 Weight (lbs): 1.65
 Fixture Finish: [AMB / GRN / PNK / RUB / SKB / SMK / TOB / TRA](#)
 Holder Finish: CHR / WHI / BLK / BCR
 Fixture Material: Glass / Metal
 Primary Material: Glass - Borosilicate
 Cable Details: 2000mm / 78 3/4" - Transparent Cable
 Upon Request: On Demand Holder Finishes - Satin Gold, Satin Bronze or Satin Black Nickel

ELECTRICAL

Lamp Type: LED
 Input Wattage (W): 7.8
 Total Output Wattage (W): 6
 Dimming: Non-Dimmable
 Driver Included: Yes
 Driver Location: Integrated
 Driver Type: Constant Current - Universal
 Driver Class: Class 2
 Input Voltage (V): 120
 Constant Current (mA): 500mA
 Upon Request: Phase Dimming (120Vac only) / 0-10V Dimming

LED

Color Temperature (°K): 3000
 Max. Delivered Lumen (lm): 864
 Nominal Lumen (lm): 886
 CRI: >90 CRI

OPTICAL

RATINGS AND CERTIFICATIONS

Certified By: Certified for North American Standards
 IP rating: IP20

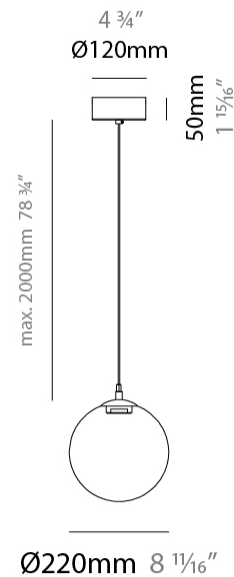

PIT - MONOPOINT SUSPENSION

D141180-

PROJECT

TYPE

SPECIFIER

QUANTITY

DATE

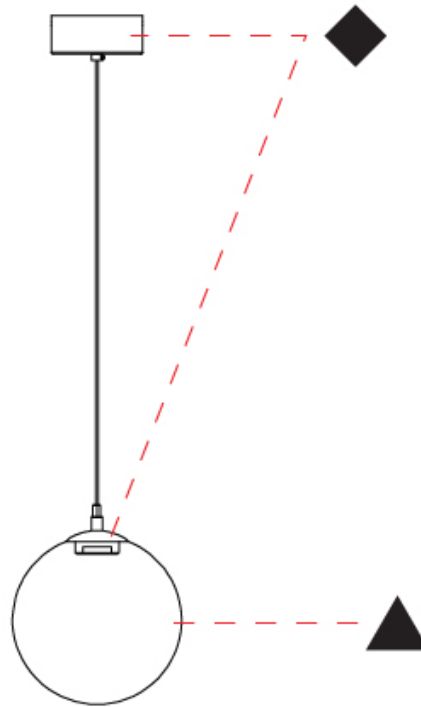

D

PIT - MONOPOINT SUSPENSION

D141181-

base number Finish Options Finish Options

- To build a product code in our configurator select the specify button on the base model # product page
- To build a manual product code on this datasheet choose from the options listed below in blue font and add the suffix to the base model #

GENERAL

Series: Pit
 Subseries: Pit - Monopoint
 Partner: Cangini & Tucci
 Division: Design
 Installation: Suspension
 Product Type: Pendant
 Mounting Location: Ceiling

PHYSICAL

Shape: Sphere
 Diameter (mm): 260
 Diameter (in): 10 1/4
 Height (mm): 260
 Height (in): 10 1/4
 Max. Overall Height (mm): 2260
 Max. Overall Height (in): 89
 Weight (kg): 0.900
 Weight (lbs): 1.98
 Fixture Finish: [AMB / GRN / PNK / RUB / SKB / SMK / TOB / TRA](#)
 Holder Finish: CHR / WHI / BLK / BCR
 Fixture Material: Glass / Metal
 Primary Material: Glass - Borosilicate
 Cable Details: 2000mm / 78 3/4" - Transparent Cable
 Upon Request: On Demand Holder Finishes - Satin Gold, Satin Bronze or Satin Black Nickel

ELECTRICAL

Lamp Type: LED
 Input Wattage (W): 7.8
 Total Output Wattage (W): 6
 Dimming: Non-Dimmable
 Driver Included: Yes
 Driver Location: Integrated
 Driver Type: Constant Current - Universal
 Driver Class: Class 2
 Input Voltage (V): 120
 Constant Current (MA): 500mA
 Upon Request: Phase Dimming (120Vac only) / 0-10V Dimming

LED

Color Temperature (°K): 3000
 Max. Delivered Lumen (lm): 866
 Nominal Lumen (lm): 886
 CRI: >90 CRI

OPTICAL

RATINGS AND CERTIFICATIONS

Certified By: Certified for North American Standards
 IP rating: IP20

PROJECT
TYPE
SPECIFIER
QUANTITY
DATE

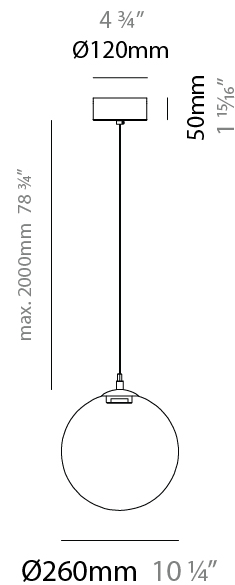

PIT - MONOPOINT SUSPENSION

D141181-

PROJECT

TYPE

SPECIFIER

QUANTITY

DATE

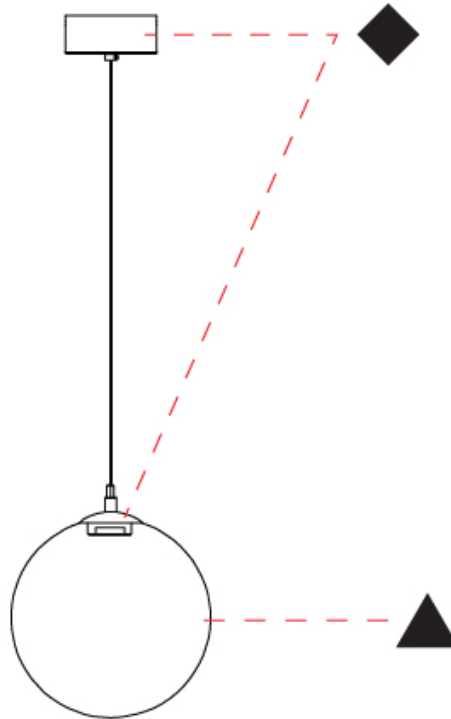

D

PIT - MONOPOINT SUSPENSION

D141182-

base number Finish Options - Finish Options

- To build a product code in our configurator select the specify button on the base model # product page
- To build a manual product code on this datasheet choose from the options listed below in blue font and add the suffix to the base model #

GENERAL

Series: Pit
 Subseries: Pit - Monopoint
 Partner: Cangini & Tucci
 Division: Design
 Installation: Suspension
 Product Type: Pendant
 Mounting Location: Ceiling

PHYSICAL

Shape: Sphere
 Diameter (mm): 300
 Diameter (in): 11 ¹³/₁₆
 Height (mm): 300
 Height (in): 11 ¹³/₁₆
 Max. Overall Height (mm): 2300
 Max. Overall Height (in): 90 ⁹/₁₆
 Weight (kg): 1.100
 Weight (lbs): 2.43
 Fixture Finish: [AMB](#) / [GRN](#) / [PNK](#) / [RUB](#) / [SKB](#) / [SMK](#) / [TOB](#) / [TRA](#)
 Holder Finish: CHR / WHI / BLK / BCR
 Fixture Material: Glass / Metal
 Primary Material: Glass - Borosilicate
 Cable Details: 2000mm / 78 3/4" - Transparent Cable
 Upon Request: On Demand Holder Finishes - Satin Gold, Satin Bronze or Satin Black Nickel

ELECTRICAL

Lamp Type: LED
 Input Wattage (W): 7.8
 Total Output Wattage (W): 6
 Dimming: Non-Dimmable
 Driver Included: Yes
 Driver Location: Integrated
 Driver Type: Constant Current - Universal
 Driver Class: Class 2
 Input Voltage (V): 120
 Constant Current (MA): 500mA
 Upon Request: Phase Dimming (120Vac only) / 0-10V Dimming

LED

Color Temperature (°K): 3000
 Max. Delivered Lumen (lm): 866
 Nominal Lumen (lm): 886
 CRI: >90 CRI

OPTICAL

RATINGS AND CERTIFICATIONS

Certified By: Certified for North American Standards
 IP rating: IP20

PROJECT
TYPE
SPECIFIER
QUANTITY
DATE



PIT - MONOPOINT SUSPENSION

D141182-

PROJECT
TYPE
SPECIFIER
QUANTITY
DATE

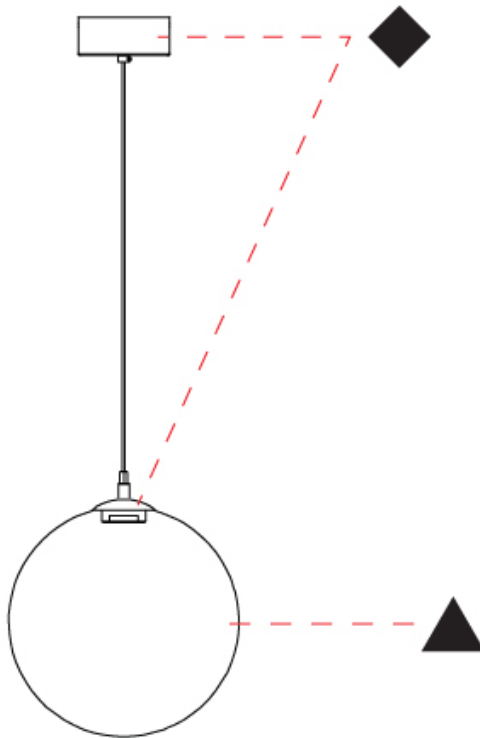

D

PIT - MONOPOINT SUSPENSION

D141183-

base number Finish Options - Finish Options

- To build a product code in our configurator select the specify button on the base model # product page
- To build a manual product code on this datasheet choose from the options listed below in blue font and add the suffix to the base model #

GENERAL

Series: Pit
 Subseries: Pit - Monopoint
 Partner: Cangini & Tucci
 Division: Design
 Installation: Suspension
 Product Type: Pendant
 Mounting Location: Ceiling

PHYSICAL

Shape: Sphere
 Diameter (mm): 360
 Diameter (in): 14 ³/₁₆
 Height (mm): 360
 Height (in): 14 ³/₁₆
 Max. Overall Height (mm): 2360
 Max. Overall Height (in): 92 ¹⁵/₁₆
 Weight (kg): 2.400
 Weight (lbs): 5.29
 Fixture Finish: [AMB](#) / [GRN](#) / [PNK](#) / [RUB](#) / [SKB](#) / [SMK](#) / [TOB](#) / [TRA](#)
 Holder Finish: [CHR](#) / [MWH](#) / [MBK](#) / [BCR](#)
 Fixture Material: Glass / Metal
 Primary Material: Glass - Borosilicate
 Cable Details: 2000mm / 78 3/4" - Transparent Cable
 Upon Request: On Demand Holder Finishes - Satin Gold, Satin Bronze or Satin Black Nickel

ELECTRICAL

Lamp Type: LED
 Input Wattage (W): 11
 Total Output Wattage (W): 8.4
 Dimming: Non-Dimmable
 Driver Included: Yes
 Driver Location: Integrated
 Driver Type: Constant Current - Universal
 Driver Class: Class 2
 Input Voltage (V): 120
 Constant Current (MA): 350mA
 Upon Request: Phase Dimming (120Vac only) / 0-10V Dimming

LED

Color Temperature (°K): 3000
 Max. Delivered Lumen (lm): 1200
 CRI: >90 CRI

OPTICAL

RATINGS AND CERTIFICATIONS

Certified By: Certified for North American Standards
 IP rating: IP20

PROJECT
TYPE
SPECIFIER
QUANTITY
DATE

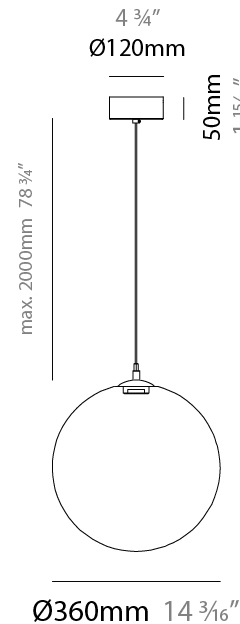

PIT - MONOPOINT SUSPENSION

D141183-

PROJECT

TYPE

SPECIFIER

QUANTITY

DATE

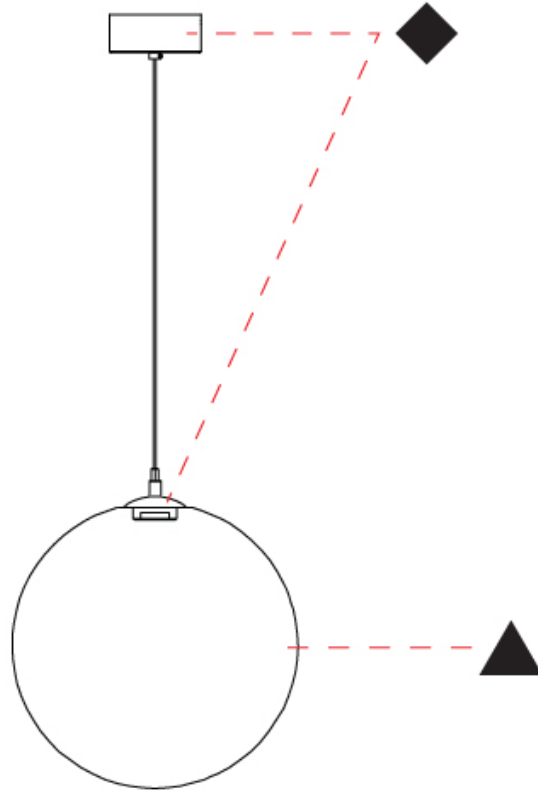

D

PROJECT	
TYPE	
SPECIFIER	
QUANTITY	
DATE	

PIT - SUSPENSION 3 LIGHT ROUND SUSPENSION

D141213-

base number Finish Options Finish Options

- To build a product code in our configurator select the specify button on the base model # product page
- To build a manual product code on this datasheet choose from the options listed below in blue font and add the suffix to the base model #

GENERAL

Series: Pit
 Subseries: Pit - Suspension 3 Light Round
 Partner: Cangini & Tucci
 Division: Design
 Installation: Suspension
 Product Type: Pendant
 Mounting Location: Ceiling

PHYSICAL

Shape: Sphere
 Diameter (mm): 520
 Diameter (in): 20 1/2
 Height (mm): 520
 Height (in): 20 1/2
 Max. Overall Height (mm): 2520
 Max. Overall Height (in): 99 3/16
 Weight (kg): 4.800
 Weight (lbs): 10.58
 Fixture Finish: [AMB](#) / [GRN](#) / [PNK](#) / [RUB](#) / [SKB](#) / [SMK](#) / [TOB](#) / [TRA](#)
 Holder Finish: CHR / MWH / MBK / BCR
 Fixture Material: Glass / Metal
 Primary Material: Glass - Borosilicate
 Cable Details: 2000mm / 78 3/4" - Transparent Cable
 Upon Request: On Demand Holder Finishes - Satin Gold, Satin Bronze or Satin Black Nickel

ELECTRICAL

Lamp Type: LED
 Input Wattage (W): 23.4
 Total Output Wattage (W): 18
 Dimming: Non-Dimmable
 Driver Included: Yes
 Driver Location: Integrated
 Driver Type: Constant Current - Universal
 Driver Class: Class 2
 Input Voltage (V): 120
 Constant Current (MA): 500mA
 Upon Request: Phase Dimming (120Vac only) / 0-10V Dimming

LED

Color Temperature (°K): 3000
 Max. Delivered Lumen (lm): 2598
 CRI: >90 CRI

OPTICAL

RATINGS AND CERTIFICATIONS

Certified By: Certified for North American Standards
 IP rating: IP20

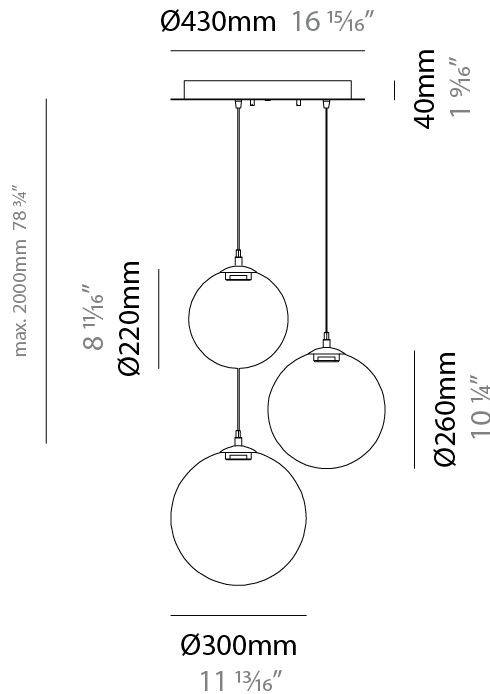

PROJECT	_____
TYPE	_____
SPECIFIER	_____
QUANTITY	_____
DATE	_____

PIT - SUSPENSION 3 LIGHT ROUND SUSPENSION

D141213-

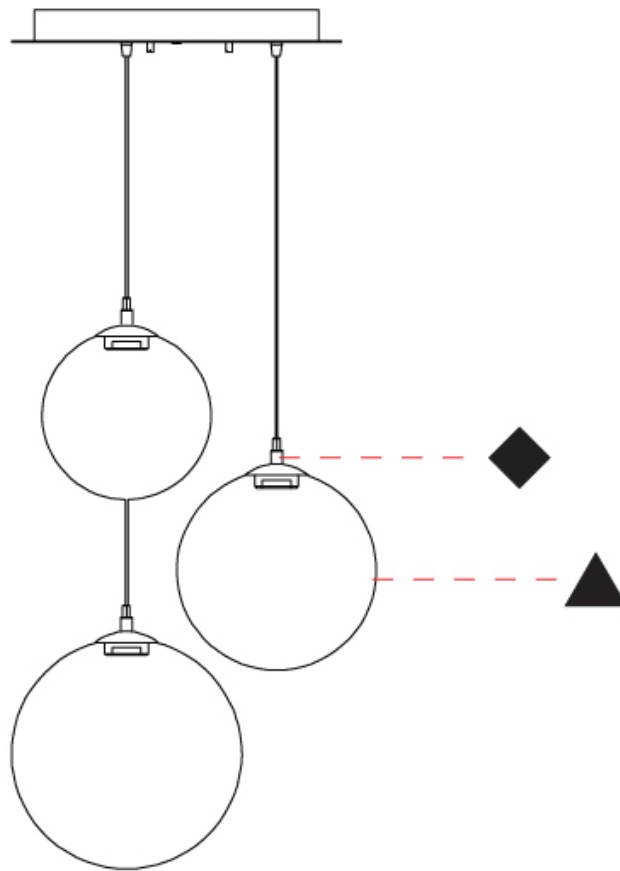

D

PROJECT	
TYPE	
SPECIFIER	
QUANTITY	
DATE	

PIT - 3 LIGHT LINEAR SUSPENSION

D141214-

base number Finish Options Finish Options

- To build a product code in our configurator select the specify button on the base model # product page
- To build a manual product code on this datasheet choose from the options listed below in blue font and add the suffix to the base model #

GENERAL

Series: Pit
 Subseries: Pit - 3 Light Linear
 Partner: Cangini & Tucci
 Division: Design
 Installation: Suspension
 Product Type: Pendant
 Mounting Location: Ceiling

PHYSICAL

Shape: Sphere
 Diameter (mm): 220
 Diameter (in): 8 11/16
 Length (mm): 1200
 Height (mm): 220
 Height (in): 8 11/16
 Max. Overall Height (mm): 2220
 Max. Overall Height (in): 87 9/16
 Weight (kg): 3.500
 Weight (lbs): 7.72
 Fixture Finish: [AMB / GRN / PNK / RUB / SKB / SMK / TOB / TRA](#)
 Holder Finish: PSS
 Accent Finish: CHR / MWH / MBK / BCR
 Fixture Material: Glass / Metal
 Primary Material: Glass - Borosilicate
 Cable Details: 2000mm / 78 3/4" - Transparent Cable
 Upon Request: On Demand Holder Finishes - Satin Gold, Satin Bronze or Satin Black Nickel

ELECTRICAL

Lamp Type: LED
 Input Wattage (W): 23.4
 Total Output Wattage (W): 18
 Dimming: Non-Dimmable
 Driver Included: Yes
 Driver Location: Integrated
 Driver Type: Constant Current - Universal
 Driver Class: Class 2
 Input Voltage (V): 120
 Constant Current (MA): 500mA
 Upon Request: Phase Dimming (120Vac only) / 0-10V Dimming

LED

Color Temperature (°K): 3000
 Max. Delivered Lumen (lm): 2598
 CRI: >90 CRI

OPTICAL

RATINGS AND CERTIFICATIONS

Certified By: Certified for North American Standards
 IP rating: IP20

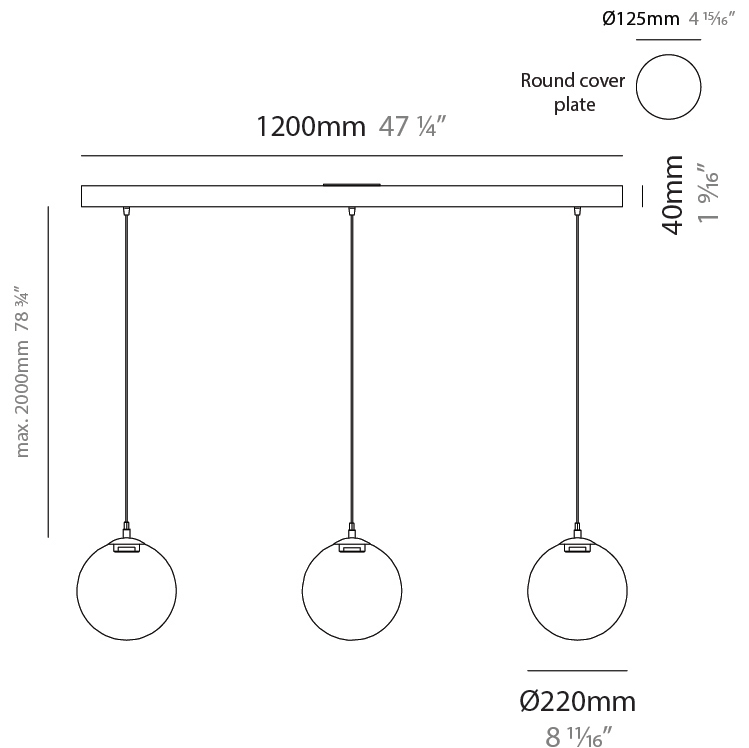

PIT - 3 LIGHT LINEAR SUSPENSION

D141214-

PROJECT	_____
TYPE	_____
SPECIFIER	_____
QUANTITY	_____
DATE	_____

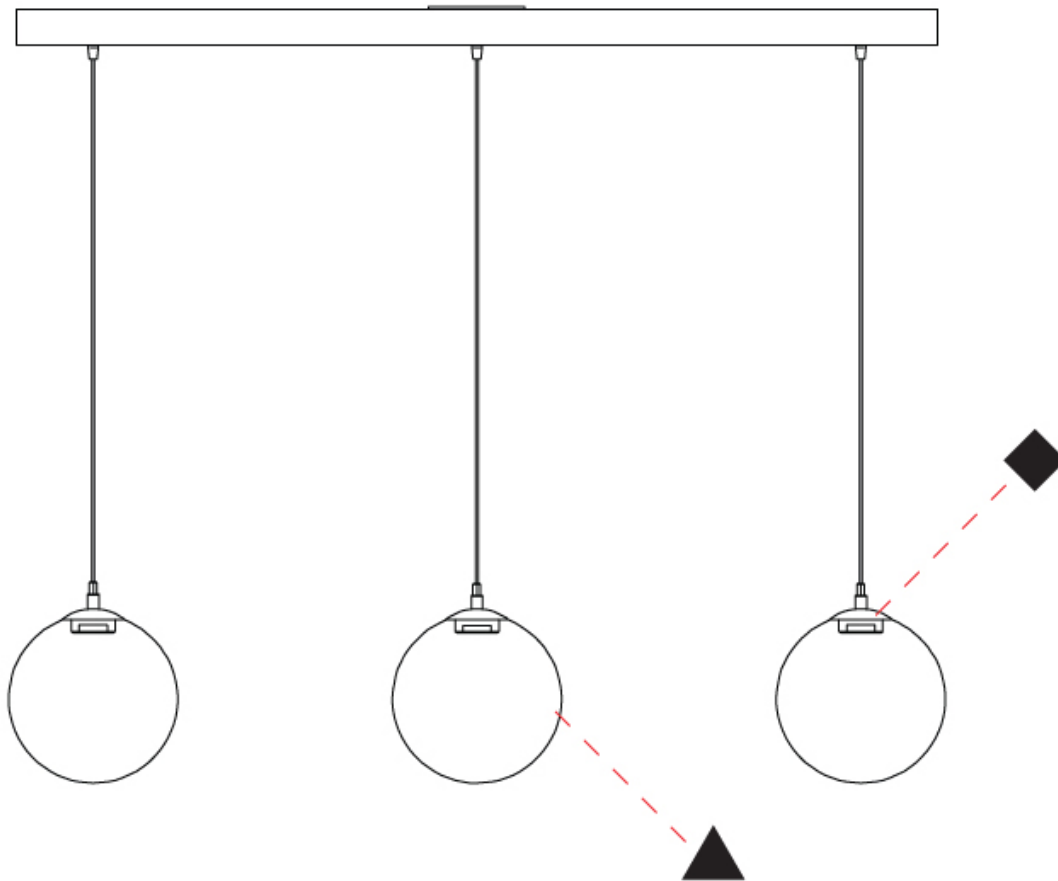

D

PROJECT
TYPE
SPECIFIER
QUANTITY
DATE

PIT - MONOPOINT SUSPENSION

D141232-

base number Finish Options Finish Options

- To build a product code in our configurator select the specify button on the base model # product page
- To build a manual product code on this datasheet choose from the options listed below in blue font and add the suffix to the base model #

GENERAL

Series: Pit
 Subseries: Pit - Monopoint
 Partner: Cangini & Tucci
 Division: Design
 Installation: Suspension
 Product Type: Pendant
 Mounting Location: Ceiling

PHYSICAL

Shape: Sphere
 Diameter (mm): 160
 Diameter (in): 6 ⁵/₁₆
 Height (mm): 160
 Height (in): 6 ⁵/₁₆
 Max. Overall Height (mm): 2160
 Max. Overall Height (in): 85 ⁷/₁₆
 Weight (kg): 0.900
 Weight (lbs): 1.98
 Diffuser: Glass - Opal
 Fixture Finish: [AMB / GRN / MBK / PNK / RUB / SKB / SMK / TOB / TRA](#)
 Holder Finish: CHR / WHI / BLK / BCR
 Fixture Material: Glass / Metal
 Primary Material: Glass - Borosilicate
 Cable Details: 2000mm / 78 3/4" - Transparent Cable
 Upon Request: On Demand Holder Finishes - Satin Gold, Satin Bronze or Satin Black Nickel

ELECTRICAL

Lamp Type: LED
 Input Wattage (W): 7.8
 Total Output Wattage (W): 6
 Dimming: Non-Dimmable
 Driver Included: Yes
 Driver Location: Integrated
 Driver Type: Constant Current - Universal
 Driver Class: Class 2
 Input Voltage (V): 120
 Constant Current (MA): 500
 Upon Request: Non-Dimming / Phase Dimming (120Vac only) / 0-10V Dimming

LED

Color Temperature (°K): 3000
 Max. Delivered Lumen (lm): 866
 Nominal Lumen (lm): 886
 CRI: >90 CRI

OPTICAL

RATINGS AND CERTIFICATIONS

Certified By: Certified for North American Standards
 IP rating: IP20

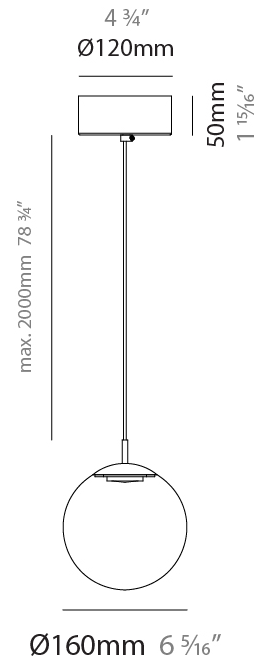

PIT - MONOPOINT SUSPENSION

D141232-

PROJECT
TYPE
SPECIFIER
QUANTITY
DATE

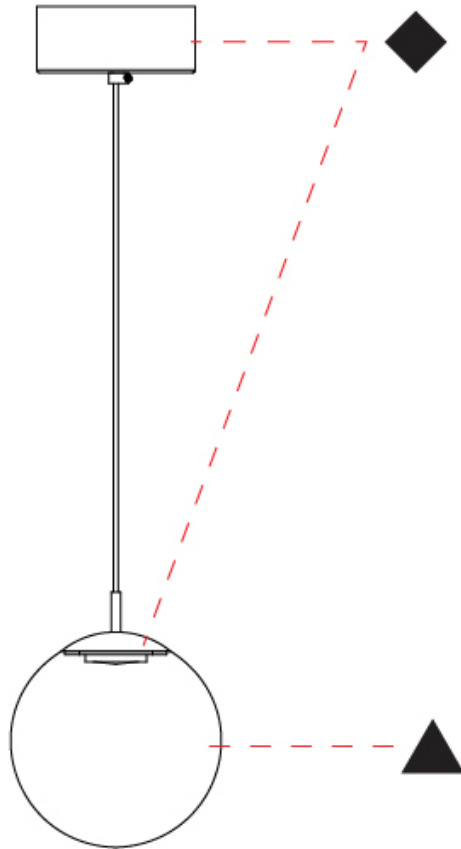

D

PIT - MONOPOINT SUSPENSION

D141233-

base number Finish Options Finish Options

- To build a product code in our configurator select the specify button on the base model # product page
- To build a manual product code on this datasheet choose from the options listed below in blue font and add the suffix to the base model #

GENERAL

Series: Pit
 Subseries: Pit - Monopoint
 Partner: Cangini & Tucci
 Division: Design
 Installation: Suspension
 Product Type: Pendant
 Mounting Location: Ceiling

PHYSICAL

Shape: Sphere
 Diameter (mm): 180
 Diameter (in): 7 1/16
 Height (mm): 180
 Height (in): 7 1/16
 Max. Overall Height (mm): 2180
 Max. Overall Height (in): 85 13/16
 Weight (kg): 0.900
 Weight (lbs): 1.98
 Diffuser: Glass - Opal
 Fixture Finish: [AMB / GRN / MBK / PNK / RUB / SKB / SMK / TOB / TRA](#)
 Holder Finish: CHR / WHI / BLK / BCR
 Fixture Material: Glass / Metal
 Primary Material: Glass - Borosilicate
 Cable Details: 2000mm / 78 3/4" - Transparent Cable
 Upon Request: On Demand Holder Finishes - Satin Gold, Satin Bronze or Satin Black Nickel

ELECTRICAL

Lamp Type: LED
 Input Wattage (W): 7.8
 Total Output Wattage (W): 6
 Dimming: Non-Dimmable
 Driver Included: Yes
 Driver Location: Integrated
 Driver Type: Constant Current - Universal
 Driver Class: Class 2
 Input Voltage (V): 120
 Constant Current (mA): 500
 Upon Request: Non-Dimming / Phase Dimming (120Vac only) / 0-10V Dimming

LED

Color Temperature (°K): 3000
 Max. Delivered Lumen (lm): 866
 Nominal Lumen (lm): 886
 CRI: >90 CRI

OPTICAL

RATINGS AND CERTIFICATIONS

Certified By: Certified for North American Standards
 IP rating: IP20

PROJECT
TYPE
SPECIFIER
QUANTITY
DATE

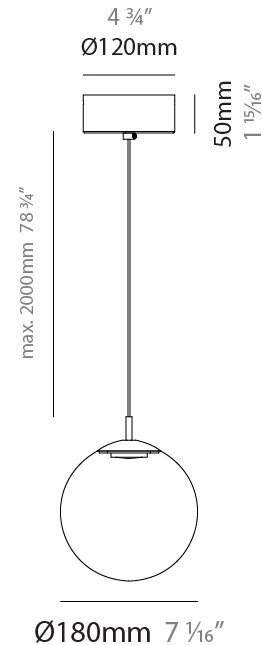

PIT - MONOPOINT SUSPENSION

D141233-

PROJECT _____

TYPE _____

SPECIFIER _____

QUANTITY _____

DATE _____

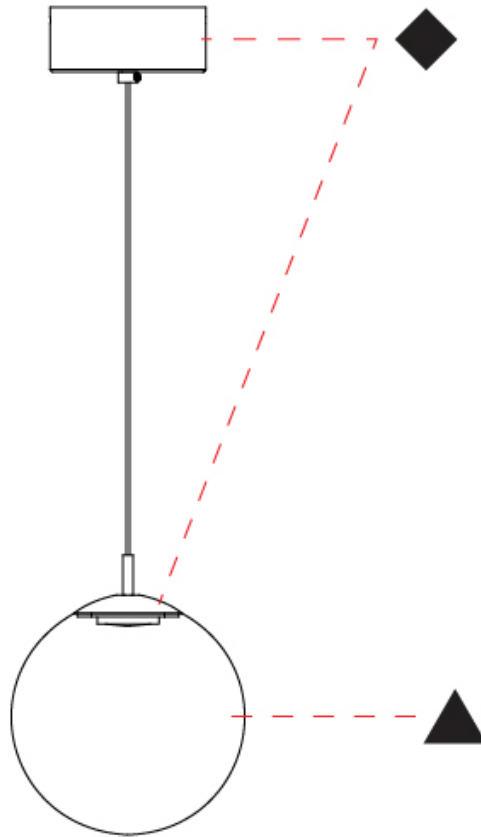

D

PROJECT
TYPE
SPECIFIER
QUANTITY
DATE

PIT - MODULAR SUSPENSION SUSPENSION

D141290-

base number Finish Options Finish Options

- To build a product code in our configurator select the specify button on the base model # product page
- To build a manual product code on this datasheet choose from the options listed below in blue font and add the suffix to the base model #

GENERAL

Series: Pit
 Subseries: Pit - Modular Suspension
 Partner: Cangini & Tucci
 Division: Design
 Installation: Suspension
 Product Type: Pendant
 Mounting Location: Ceiling

PHYSICAL

Shape: Sphere
 Diameter (mm): 180
 Diameter (in): 7 1/16
 Height (mm): 180
 Height (in): 7 1/16
 Max. Overall Height (mm): 2180
 Max. Overall Height (in): 85 13/16
 Weight (kg): 0.900
 Weight (lbs): 1.98
 Diffuser: Glass - Opal
 Fixture Finish: [AMB / GRN / MBK / PNK / RUB / SKB / SMK / TOB / TRA](#)
 Holder Finish: CHR / WHI / BLK / BCR
 Fixture Material: Glass / Metal
 Primary Material: Glass - Borosilicate
 Cable Details: 2000mm / 78 3/4" - Transparent Cable
 Upon Request: On Demand Holder Finishes - Satin Gold, Satin Bronze or Satin Black Nickel

ELECTRICAL

Lamp Type: LED
 Input Wattage (W): 7.8
 Total Output Wattage (W): 6
 Dimming: Non-Dimmable
 Driver Included: Yes
 Driver Location: Integrated
 Driver Type: Constant Current - Universal
 Driver Class: Class 2
 Input Voltage (V): 120
 Constant Current (mA): 500
 Upon Request: Non-Dimming / Phase Dimming (120Vac only) / 0-10V Dimming

LED

Color Temperature (°K): 3000
 Max. Delivered Lumen (lm): 866
 Nominal Lumen (lm): 886
 CRI: >90 CRI

OPTICAL

RATINGS AND CERTIFICATIONS

Certified By: Certified for North American Standards
 IP rating: IP20

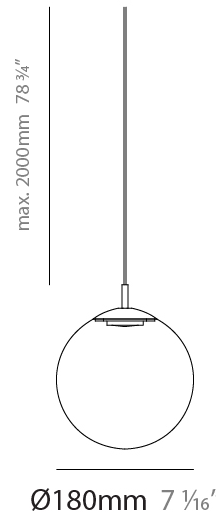

PIT - MODULAR SUSPENSION SUSPENSION

D141290-

PROJECT _____

TYPE _____

SPECIFIER _____

QUANTITY _____

DATE _____

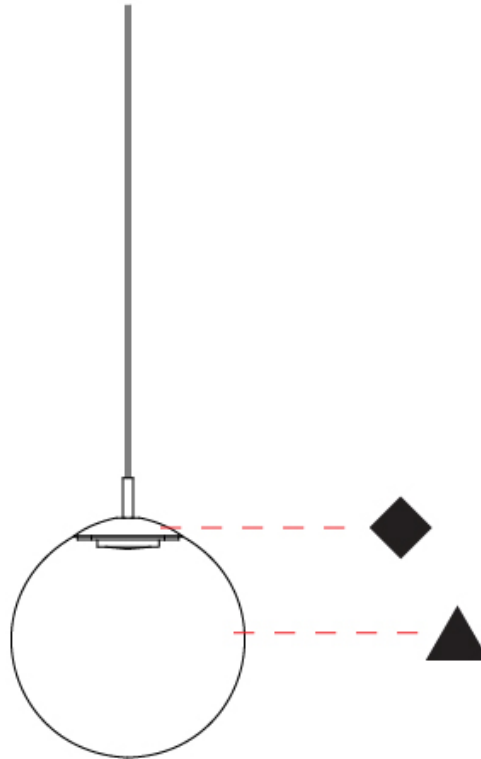

D

PROJECT
TYPE
SPECIFIER
QUANTITY
DATE

PIT PORTABLE

D144036-

base number Color Finish Finish
 Temperature Options Options

- To build a product code in our configurator select the specify button on the base model # product page
- To build a manual product code on this datasheet choose from the options listed below in blue font and add the suffix to the base model #

GENERAL

Series: Pit
 Partner: Cangini & Tucci
 Division: Design
 Installation: Portable
 Product Type: Table
 Mounting Location: Table

PHYSICAL

Shape: Sphere
 Diameter (mm): 220
 Diameter (in): 8 11/16
 Height (mm): 500
 Height (in): 19 11/16
 Weight (kg): 1.8
[Fixture Finish: AMB / GRN / PNK / RUB / SKB / SMK / TOB / TRA](#)
 Holder Finish: SGD / SRG / SBN
 Fixture Material: Glass / Metal
 Primary Material: Glass - Borosilicate
 Cable Details: 2000mm / 78 3/4" - Transparent Cable

ELECTRICAL

Lamp Type: LED
 Input Wattage (W): 6
 Dimming: Non-Dimmable
 Driver Included: Yes
 Driver Location: Integrated
 Driver Type: Constant Current - Universal
 Driver Class: Class 2
 Input Voltage (V): 120 - 277
 Constant Current (MA): 500

LED

[Color Temperature \(°K\): 2700 / 3000](#)
 Max. Delivered Lumen (lm): 144
 Nominal Lumen (lm): 866
 CRI: >90 CRI
 Lamp Life (hrs): 50000

OPTICAL

RATINGS AND CERTIFICATIONS

Certified By: Certified for North American Standards
 IP rating: IP20

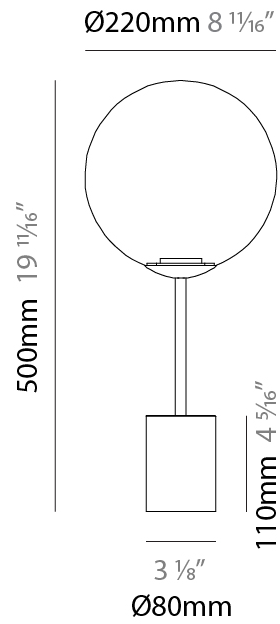

PIT PORTABLE

D144036-

PROJECT
TYPE
SPECIFIER
QUANTITY
DATE

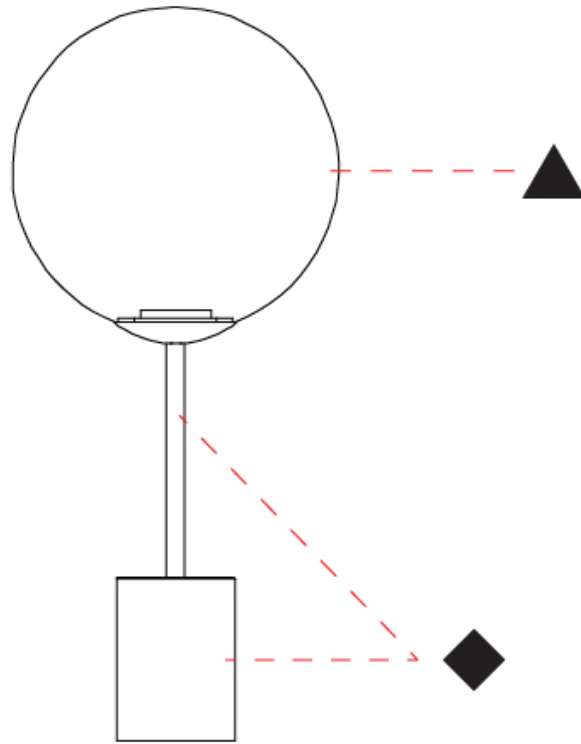

D

PROJECT	_____
TYPE	_____
SPECIFIER	_____
QUANTITY	_____
DATE	_____

PIT PORTABLE

D144037-

base number Color Finish Finish
 Temperature Options Options

- To build a product code in our configurator select the specify button on the base model # product page
- To build a manual product code on this datasheet choose from the options listed below in blue font and add the suffix to the base model #

GENERAL

Series: Pit
 Partner: Cangini & Tucci
 Division: Design
 Installation: Portable
 Product Type: Table
 Mounting Location: Floor

PHYSICAL

Shape: Sphere
 Diameter (mm): 300
 Diameter (in): 11 ¹³/₁₆
 Height (mm): 1750
 Height (in): 68 ⁷/₈
 Weight (kg): 5.3
 Fixture Finish: [AMB / GRN / PNK / RUB / SKB / SMK / TOB / TRA](#)
 Holder Finish: [SGD / SRG / SBN](#)
 Fixture Material: Glass / Metal
 Primary Material: Glass - Borosilicate
 Cable Details: 2000mm / 78 3/4" - Transparent Cable

ELECTRICAL

Lamp Type: LED
 Input Wattage (W): 8.4
 Dimming: Non-Dimmable
 Driver Included: Yes
 Driver Location: Integrated
 Driver Type: Constant Current - Universal
 Driver Class: Class 2
 Input Voltage (V): 120 - 277
 Constant Current (MA): 700
 Upon Request: Phase Dimming

LED

Color Temperature (°K): [2700 / 3000](#)
 Max. Delivered Lumen (lm): 144
 Nominal Lumen (lm): 1200
 CRI: >90 CRI
 Lamp Life (hrs): 50000

OPTICAL

RATINGS AND CERTIFICATIONS

Certified By: Certified for North American Standards
 IP rating: IP20



Ø300mm 11 ¹³/₁₆"

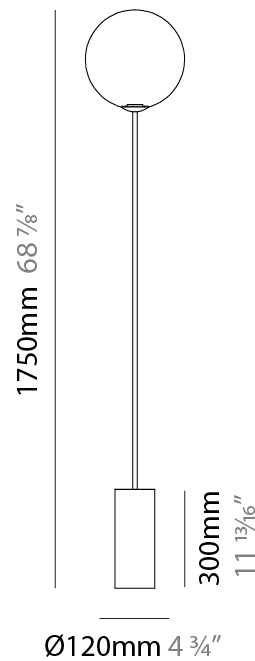

PIT PORTABLE

D144037-

PROJECT

TYPE

SPECIFIER

QUANTITY

DATE

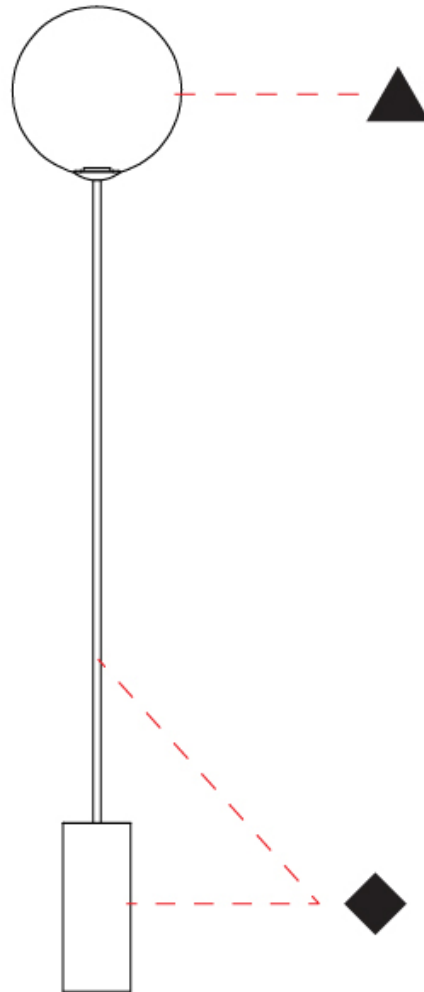

D

PROJECT _____
 TYPE _____
 SPECIFIER _____
 QUANTITY _____
 DATE _____

PIT COLOR FINISH CHART

Fixture Finish

Amber - AMB



Green - GRN



Matte Black - MBK



Pink - PNK



Ruby - RUB



Sky Blue - SKB



Smoke - SMK



Tobacco - TOB



Transparent - TRA



Holder Finish

Chrome - CHR



Matte White - MWH



Matte Black - MBK



Brushed Chrome - BCR

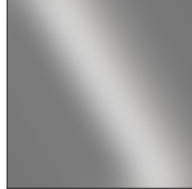

White - WHI

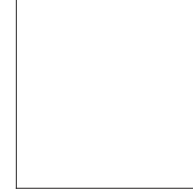

Black - BLK

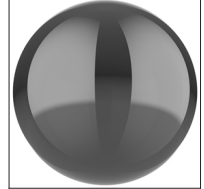

Polished Stainless Steel - PSS



Satin Gold - SGD

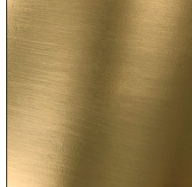

Satin Rose Gold - SRG



Satin Black Nickel - SBN



PIT - 3 LIGHT LINEAR, PIT - MODULAR SUSPENSION, PIT - MONOPOINT, PIT - SUSPENSION 3 LIGHT ROUND

PORTABLE, SUSPENSION

COLOR FINISH CHART

Accent Finish

Chrome - CHR



Matte White - MWH



Matte Black - MBK

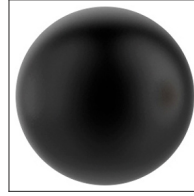

Brushed Chrome - BCR

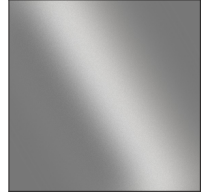

Digital: Not all screens are calibrated the same, and therefore, colors will appear differently between screens.

Physical: When texture is involved, there will be variations in color, character and tone within a product series and between product families.













LEGEND

	floor-mounted		pivotal		special LED (upon request) RGB, RGBW, tunable, gold+, meat+, art+, fashion+
	wall and ceiling: recessed and surface mounted		rotating		warm dim / natural dimming LED
	ceiling-mounted and wall-mounted		illuminate tilted		rechargeable battery powered
	wall-mounted		color of suspension cable		fixture with natural vivid LED (upon request)
	omni-directional light distribution		length of suspension cable		color rendering index
	direct light distribution		reflector degree selection		color temperature
	direct/indirect light distribution		super spot		lumen (luminous flux)
	indirect light distribution		lens		efficacy (lumens per watt)
	asymmetric light distribution		lens pack		Unified Glare Rating (UGR) range from 5-40
	aura light distribution		shine ring		marine grade (AISI 316 stainless steel)
	round wall or ceiling cut-out		integrated shine ring with diffuser		walk on
	square wall or ceiling cut-out		free individual colors 01-29		drive on
	the supplied jig specifies the cutout dimensions		individual colors: 00 (free of charge), 01-25 (extra charge)		Dark Sky Compliance
	minimum distance (meters) lamp - object		luminaire part to be colored (F1)		Americans with Disabilities Act (less than 4" off the wall located between 27"-84" from floor)
	recessed depth		luminaire part to be colored (F2)		lamp protected against explosion
	ceiling thickness in mm		luminaire part to be colored (F3)		blown glass using traditional methods by master glass blower
	ceiling thickness selection		luminaire part to be colored (F4)		acoustic material
	dimmable DP (phase), DV (0-10V), DD (dali), DS (step-dim)		luminaire part to be colored (F5)		protection class I, protection insulation
	included or excluded LED driver/transformer/control gear		color of 3-circuit adaptor		protection class II, protection insulation
	separately switchable		indirect diffuser		ETL Certified to UL and CSA Standards
	sensor		direct diffuser		UL Certified to UL and CSA Standards
	remote control		ball-proof (upon request)		CSA Certified to UL and CSA Standards
	available upon request		accessory		Certified for North American Standards

IP RATING

	protected against ingress of solid bodies greater than 12.5mm (finger)
	protected against ingress of solid bodies greater than 2.5mm protected against sprays of water up to 60 degrees from the vertical (rain)
	protected against ingress of solid bodies greater than 1mm (wire) no protection against the ingress of moisture
	protected against ingress of solid bodies greater than 1mm (wire) protected against sprays of water up to 60 degrees from the vertical (rain)
	protected against ingress of solid bodies greater than 1mm (wire) protected against water splashed from all directions
	protected against limited ingress of dust (wet rooms/covered outdoor areas) protected against water splashed from all directions
	protected against ingress of dust protected against jets of water
	protected against ingress of dust protected against powerful jets of water or heavy seas
	protected against ingress of dust protected against immersion of water between 15cm - 1m for 30 minutes
	protected against ingress of dust protected against immersion of water under pressure for long periods

IK RATING

	protected against 0.14 joules impact (equivalent to 0.25kg mass dropped from 56mm above the surface)
	protected against 0.2 joules impact (equivalent to 0.25kg mass dropped from 80mm above the surface)
	protected against 0.35 joules impact (equivalent to 0.25kg mass dropped from 140mm above the surface)
	protected against 0.5 joules impact (equivalent to 0.25kg mass dropped from 200mm above the surface)
	protected against 0.7 joules impact (equivalent to 0.25kg mass dropped from 280mm above the surface)
	protected against 1 joules impact (equivalent to 0.25kg mass dropped from 400mm above the surface)
	protected against 2 joules impact (equivalent to 0.5kg mass dropped from 400mm above the surface)
	protected against 5 joules impact (equivalent to 1.7kg mass dropped from 300mm above the surface)
	protected against 10 joules impact (equivalent to 5.0kg mass dropped from 200mm above the surface)
	protected against 20 joules impact (equivalent to 5.0kg mass dropped from 400mm above the surface)