

## PIT - MONOPOINT SUSPENSION

### D141180-

base number      Finish Options      -      Finish Options

- To build a product code in our configurator select the specify button on the base model # product page
- To build a manual product code on this datasheet choose from the options listed below in blue font and add the suffix to the base model #

#### GENERAL

Series: Pit  
 Subseries: Pit - Monopoint  
 Partner: Cangini & Tucci  
 Division: Design  
 Installation: Suspension  
 Product Type: Pendant  
 Mounting Location: Ceiling

#### PHYSICAL

Shape: Sphere  
 Diameter (mm): 220  
 Diameter (in): 8 <sup>11</sup>/<sub>16</sub>  
 Height (mm): 220  
 Height (in): 8 <sup>11</sup>/<sub>16</sub>  
 Max. Overall Height (mm): 2220  
 Max. Overall Height (in): 87 <sup>3</sup>/<sub>8</sub>  
 Weight (kg): 0.750  
 Weight (lbs): 1.65  
 Fixture Finish: [AMB](#) / [GRN](#) / [PNK](#) / [RUB](#) / [SKB](#) / [SMK](#) / [TOB](#) / [TRA](#)  
 Holder Finish: CHR / WHI / BLK / BCR  
 Fixture Material: Glass / Metal  
 Primary Material: Glass - Borosilicate  
 Cable Details: 2000mm / 78 3/4" - Transparent Cable  
 Upon Request: On Demand Holder Finishes - Satin Gold, Satin Bronze or Satin Black Nickel

#### ELECTRICAL

Lamp Type: LED  
 Input Wattage (W): 7.8  
 Total Output Wattage (W): 6  
 Dimming: Non-Dimmable  
 Driver Included: Yes  
 Driver Location: Integrated  
 Driver Type: Constant Current - Universal  
 Driver Class: Class 2  
 Input Voltage (V): 120  
 Constant Current (MA): 500mA  
 Upon Request: Phase Dimming (120Vac only) / 0-10V Dimming

#### LED

Color Temperature (°K): 3000  
 Max. Delivered Lumen (lm): 864  
 Nominal Lumen (lm): 886  
 CRI: >90 CRI

#### OPTICAL

#### RATINGS AND CERTIFICATIONS

Certified By: Certified for North American Standards  
 IP rating: IP20

PROJECT
TYPE
SPECIFIER
QUANTITY
DATE

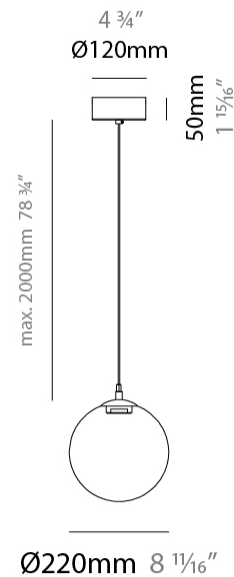

## PIT - MONOPOINT SUSPENSION

D141180-

PROJECT
TYPE
SPECIFIER
QUANTITY
DATE

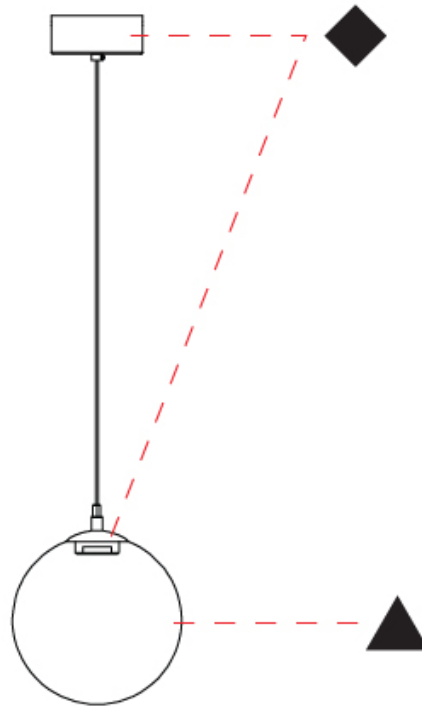

D

PROJECT
TYPE
SPECIFIER
QUANTITY
DATE

## PIT - MONOPOINT SUSPENSION

### D141181-

base number      Finish Options      Finish Options

- To build a product code in our configurator select the specify button on the base model # product page
- To build a manual product code on this datasheet choose from the options listed below in blue font and add the suffix to the base model #

#### GENERAL

Series: Pit  
 Subseries: Pit - Monopoint  
 Partner: Cangini & Tucci  
 Division: Design  
 Installation: Suspension  
 Product Type: Pendant  
 Mounting Location: Ceiling

#### PHYSICAL

Shape: Sphere  
 Diameter (mm): 260  
 Diameter (in): 10 1/4  
 Height (mm): 260  
 Height (in): 10 1/4  
 Max. Overall Height (mm): 2260  
 Max. Overall Height (in): 89  
 Weight (kg): 0.900  
 Weight (lbs): 1.98  
 Fixture Finish: [AMB / GRN / PNK / RUB / SKB / SMK / TOB / TRA](#)  
 Holder Finish: CHR / WHI / BLK / BCR  
 Fixture Material: Glass / Metal  
 Primary Material: Glass - Borosilicate  
 Cable Details: 2000mm / 78 3/4" - Transparent Cable  
 Upon Request: On Demand Holder Finishes - Satin Gold, Satin Bronze or Satin Black Nickel

#### ELECTRICAL

Lamp Type: LED  
 Input Wattage (W): 7.8  
 Total Output Wattage (W): 6  
 Dimming: Non-Dimmable  
 Driver Included: Yes  
 Driver Location: Integrated  
 Driver Type: Constant Current - Universal  
 Driver Class: Class 2  
 Input Voltage (V): 120  
 Constant Current (MA): 500mA  
 Upon Request: Phase Dimming (120Vac only) / 0-10V Dimming

#### LED

Color Temperature (°K): 3000  
 Max. Delivered Lumen (lm): 866  
 Nominal Lumen (lm): 886  
 CRI: >90 CRI

#### OPTICAL

#### RATINGS AND CERTIFICATIONS

Certified By: Certified for North American Standards  
 IP rating: IP20

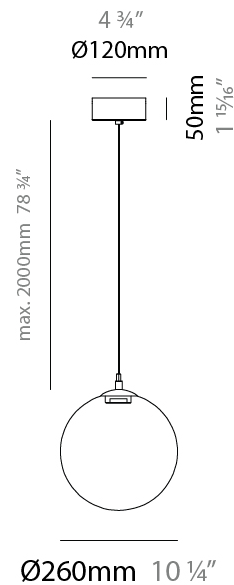

## PIT - MONOPOINT SUSPENSION

D141181-

PROJECT	_____
TYPE	_____
SPECIFIER	_____
QUANTITY	_____
DATE	_____

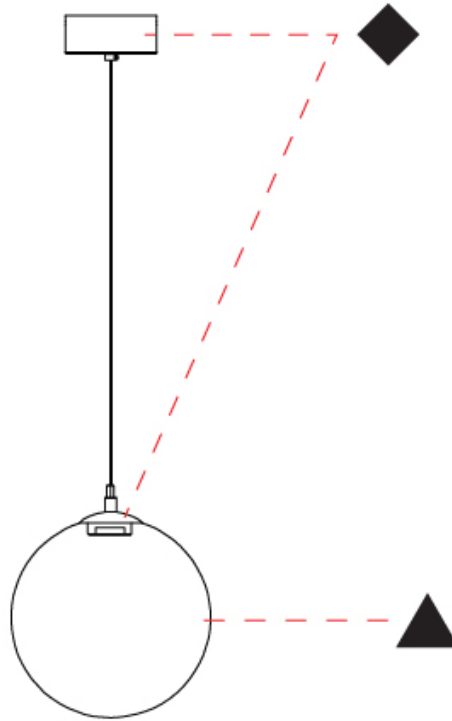

D

## PIT - MONOPOINT SUSPENSION

### D141182-

base number      Finish      Finish  
Options            Options

- To build a product code in our configurator select the specify button on the base model # product page
- To build a manual product code on this datasheet choose from the options listed below in blue font and add the suffix to the base model #

#### GENERAL

Series: Pit  
Subseries: Pit - Monopoint  
Partner: Cangini & Tucci  
Division: Design  
Installation: Suspension  
Product Type: Pendant  
Mounting Location: Ceiling

#### PHYSICAL

Shape: Sphere  
Diameter (mm): 300  
Diameter (in): 11 <sup>13</sup>/<sub>16</sub>  
Height (mm): 300  
Height (in): 11 <sup>13</sup>/<sub>16</sub>  
Max. Overall Height (mm): 2300  
Max. Overall Height (in): 90 <sup>9</sup>/<sub>16</sub>  
Weight (kg): 1.100  
Weight (lbs): 2.43  
[Fixture Finish: AMB / GRN / PNK / RUB / SKB / SMK / TOB / TRA](#)  
Holder Finish: CHR / WHI / BLK / BCR  
Fixture Material: Glass / Metal  
Primary Material: Glass - Borosilicate  
Cable Details: 2000mm / 78 3/4" - Transparent Cable  
Upon Request: On Demand Holder Finishes - Satin Gold, Satin Bronze or Satin Black Nickel

#### ELECTRICAL

Lamp Type: LED  
Input Wattage (W): 7.8  
Total Output Wattage (W): 6  
Dimming: Non-Dimmable  
Driver Included: Yes  
Driver Location: Integrated  
Driver Type: Constant Current - Universal  
Driver Class: Class 2  
Input Voltage (V): 120  
Constant Current (MA): 500mA  
Upon Request: Phase Dimming (120Vac only) / 0-10V Dimming

#### LED

Color Temperature (°K): 3000  
Max. Delivered Lumen (lm): 866  
Nominal Lumen (lm): 886  
CRI: >90 CRI

#### OPTICAL

#### RATINGS AND CERTIFICATIONS

Certified By: Certified for North American Standards  
IP rating: IP20

PROJECT
TYPE
SPECIFIER
QUANTITY
DATE



## PIT - MONOPOINT SUSPENSION

D141182-

PROJECT	_____
TYPE	_____
SPECIFIER	_____
QUANTITY	_____
DATE	_____

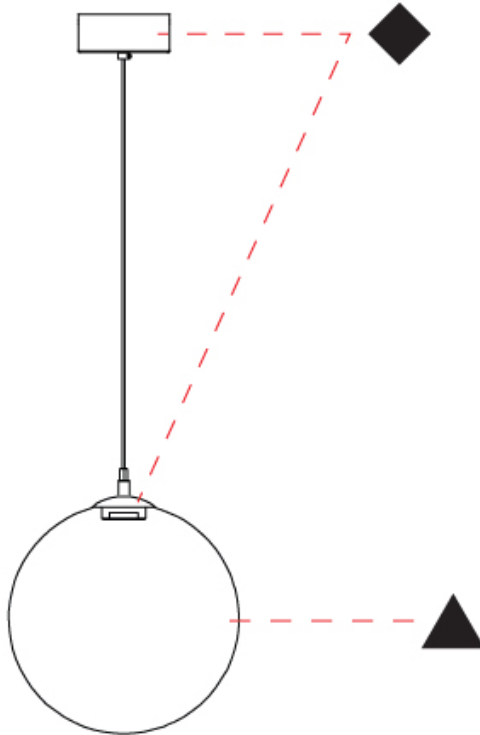

D

PROJECT
TYPE
SPECIFIER
QUANTITY
DATE

## PIT - MONOPOINT SUSPENSION

### D141183-

base number      Finish Options      Finish Options

- To build a product code in our configurator select the specify button on the base model # product page
- To build a manual product code on this datasheet choose from the options listed below in blue font and add the suffix to the base model #

#### GENERAL

Series: Pit  
 Subseries: Pit - Monopoint  
 Partner: Cangini & Tucci  
 Division: Design  
 Installation: Suspension  
 Product Type: Pendant  
 Mounting Location: Ceiling

#### PHYSICAL

Shape: Sphere  
 Diameter (mm): 360  
 Diameter (in): 14 <sup>3</sup>/<sub>16</sub>  
 Height (mm): 360  
 Height (in): 14 <sup>3</sup>/<sub>16</sub>  
 Max. Overall Height (mm): 2360  
 Max. Overall Height (in): 92 <sup>15</sup>/<sub>16</sub>  
 Weight (kg): 2.400  
 Weight (lbs): 5.29  
 Fixture Finish: [AMB](#) / [GRN](#) / [PNK](#) / [RUB](#) / [SKB](#) / [SMK](#) / [TOB](#) / [TRA](#)  
 Holder Finish: [CHR](#) / [MWH](#) / [MBK](#) / [BCR](#)  
 Fixture Material: Glass / Metal  
 Primary Material: Glass - Borosilicate  
 Cable Details: 2000mm / 78 3/4" - Transparent Cable  
 Upon Request: On Demand Holder Finishes - Satin Gold, Satin Bronze or Satin Black Nickel

#### ELECTRICAL

Lamp Type: LED  
 Input Wattage (W): 11  
 Total Output Wattage (W): 8.4  
 Dimming: Non-Dimmable  
 Driver Included: Yes  
 Driver Location: Integrated  
 Driver Type: Constant Current - Universal  
 Driver Class: Class 2  
 Input Voltage (V): 120  
 Constant Current (MA): 350mA  
 Upon Request: Phase Dimming (120Vac only) / 0-10V Dimming

#### LED

Color Temperature (°K): 3000  
 Max. Delivered Lumen (lm): 1200  
 CRI: >90 CRI

#### OPTICAL

#### RATINGS AND CERTIFICATIONS

Certified By: Certified for North American Standards  
 IP rating: IP20

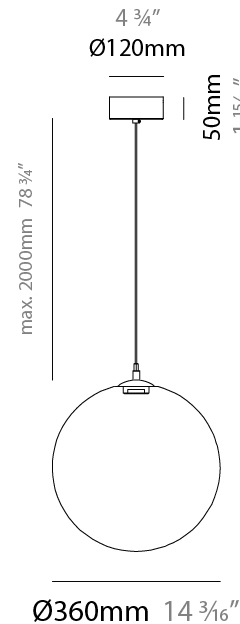

## PIT - MONOPOINT SUSPENSION

D141183-

PROJECT	_____
TYPE	_____
SPECIFIER	_____
QUANTITY	_____
DATE	_____

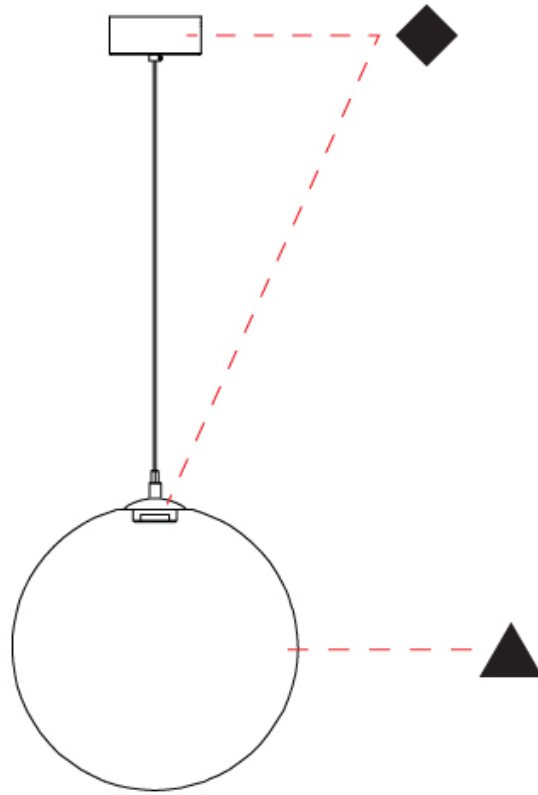

D

PROJECT	
TYPE	
SPECIFIER	
QUANTITY	
DATE	

## PIT - SUSPENSION 3 LIGHT ROUND SUSPENSION

### D141213-

base number      Finish Options      Finish Options

- To build a product code in our configurator select the specify button on the base model # product page
- To build a manual product code on this datasheet choose from the options listed below in blue font and add the suffix to the base model #

#### GENERAL

Series: Pit  
 Subseries: Pit - Suspension 3 Light Round  
 Partner: Cangini & Tucci  
 Division: Design  
 Installation: Suspension  
 Product Type: Pendant  
 Mounting Location: Ceiling

#### PHYSICAL

Shape: Sphere  
 Diameter (mm): 520  
 Diameter (in): 20 1/2  
 Height (mm): 520  
 Height (in): 20 1/2  
 Max. Overall Height (mm): 2520  
 Max. Overall Height (in): 99 3/16  
 Weight (kg): 4.800  
 Weight (lbs): 10.58  
 Fixture Finish: [AMB](#) / [GRN](#) / [PNK](#) / [RUB](#) / [SKB](#) / [SMK](#) / [TOB](#) / [TRA](#)  
 Holder Finish: CHR / MWH / MBK / BCR  
 Fixture Material: Glass / Metal  
 Primary Material: Glass - Borosilicate  
 Cable Details: 2000mm / 78 3/4" - Transparent Cable  
 Upon Request: On Demand Holder Finishes - Satin Gold, Satin Bronze or Satin Black Nickel

#### ELECTRICAL

Lamp Type: LED  
 Input Wattage (W): 23.4  
 Total Output Wattage (W): 18  
 Dimming: Non-Dimmable  
 Driver Included: Yes  
 Driver Location: Integrated  
 Driver Type: Constant Current - Universal  
 Driver Class: Class 2  
 Input Voltage (V): 120  
 Constant Current (MA): 500mA  
 Upon Request: Phase Dimming (120Vac only) / 0-10V Dimming

#### LED

Color Temperature (°K): 3000  
 Max. Delivered Lumen (lm): 2598  
 CRI: >90 CRI

#### OPTICAL

#### RATINGS AND CERTIFICATIONS

Certified By: Certified for North American Standards  
 IP rating: IP20

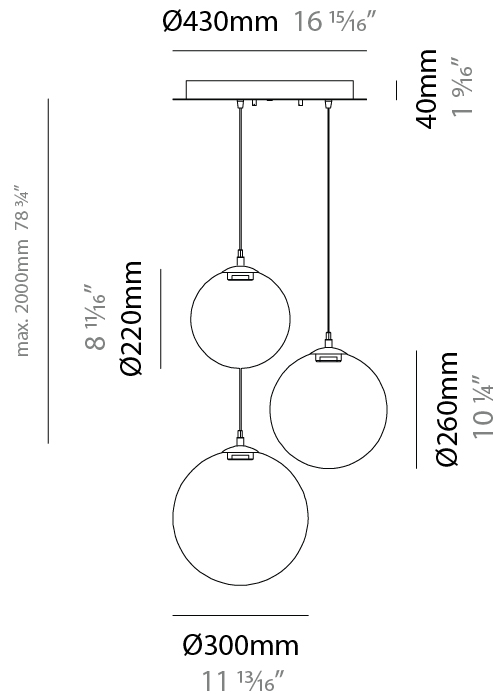

PROJECT	_____
TYPE	_____
SPECIFIER	_____
QUANTITY	_____
DATE	_____

## PIT - SUSPENSION 3 LIGHT ROUND SUSPENSION

D141213-

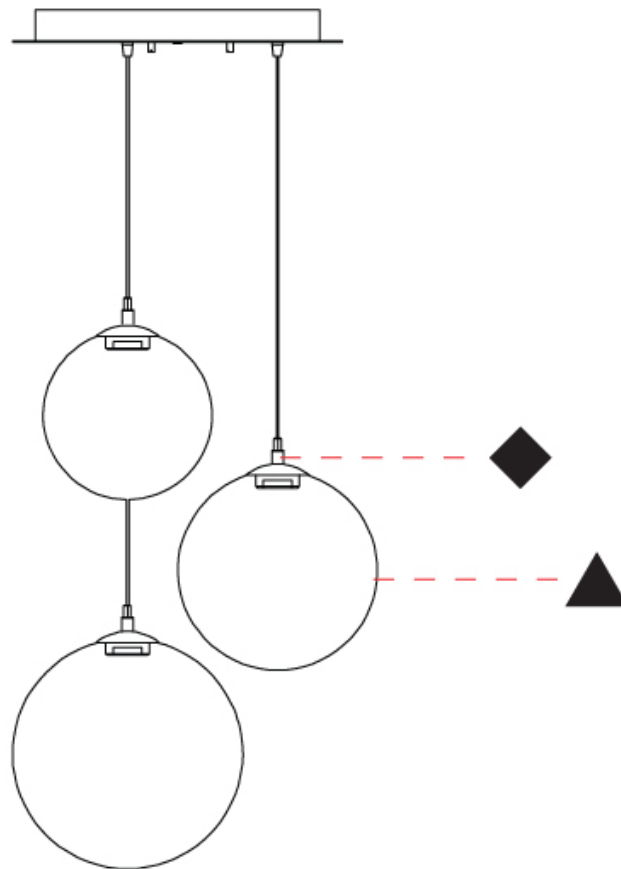

D

PROJECT	
TYPE	
SPECIFIER	
QUANTITY	
DATE	

## PIT - 3 LIGHT LINEAR SUSPENSION

### D141214-

base number      Finish Options      Finish Options

- To build a product code in our configurator select the specify button on the base model # product page
- To build a manual product code on this datasheet choose from the options listed below in blue font and add the suffix to the base model #

#### GENERAL

Series: Pit  
 Subseries: Pit - 3 Light Linear  
 Partner: Cangini & Tucci  
 Division: Design  
 Installation: Suspension  
 Product Type: Pendant  
 Mounting Location: Ceiling

#### PHYSICAL

Shape: Sphere  
 Diameter (mm): 220  
 Diameter (in): 8 11/16  
 Length (mm): 1200  
 Height (mm): 220  
 Height (in): 8 11/16  
 Max. Overall Height (mm): 2220  
 Max. Overall Height (in): 87 9/16  
 Weight (kg): 3.500  
 Weight (lbs): 7.72  
 Fixture Finish: [AMB / GRN / PNK / RUB / SKB / SMK / TOB / TRA](#)  
 Holder Finish: PSS  
 Accent Finish: CHR / MWH / MBK / BCR  
 Fixture Material: Glass / Metal  
 Primary Material: Glass - Borosilicate  
 Cable Details: 2000mm / 78 3/4" - Transparent Cable  
 Upon Request: On Demand Holder Finishes - Satin Gold, Satin Bronze or Satin Black Nickel

#### ELECTRICAL

Lamp Type: LED  
 Input Wattage (W): 23.4  
 Total Output Wattage (W): 18  
 Dimming: Non-Dimmable  
 Driver Included: Yes  
 Driver Location: Integrated  
 Driver Type: Constant Current - Universal  
 Driver Class: Class 2  
 Input Voltage (V): 120  
 Constant Current (MA): 500mA  
 Upon Request: Phase Dimming (120Vac only) / 0-10V Dimming

#### LED

Color Temperature (°K): 3000  
 Max. Delivered Lumen (lm): 2598  
 CRI: >90 CRI

#### OPTICAL

#### RATINGS AND CERTIFICATIONS

Certified By: Certified for North American Standards  
 IP rating: IP20

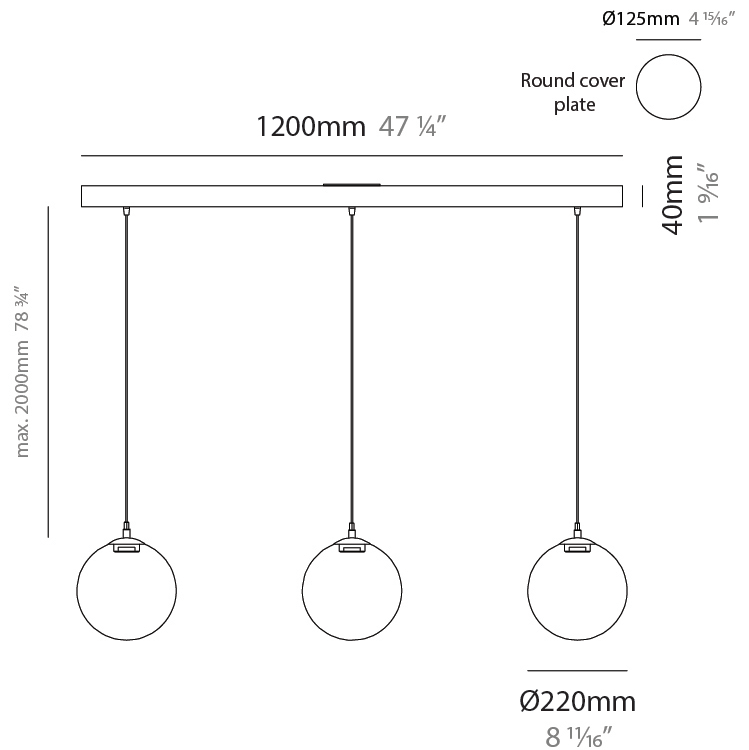

## PIT - 3 LIGHT LINEAR SUSPENSION

D141214-

PROJECT	_____
TYPE	_____
SPECIFIER	_____
QUANTITY	_____
DATE	_____

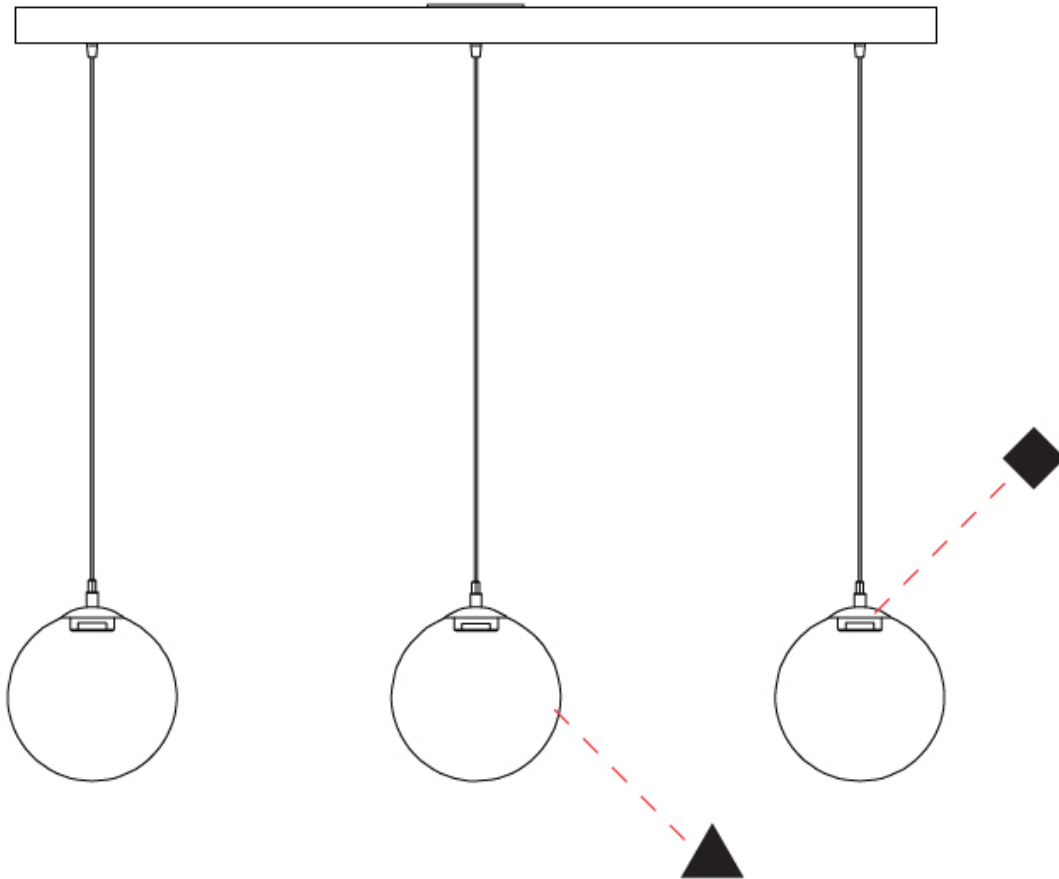

D

## PIT - MONOPOINT SUSPENSION

### D141232-

base number      Finish Options      -      Finish Options

- To build a product code in our configurator select the specify button on the base model # product page
- To build a manual product code on this datasheet choose from the options listed below in blue font and add the suffix to the base model #

#### GENERAL

Series: Pit  
 Subseries: Pit - Monopoint  
 Partner: Cangini & Tucci  
 Division: Design  
 Installation: Suspension  
 Product Type: Pendant  
 Mounting Location: Ceiling

#### PHYSICAL

Shape: Sphere  
 Diameter (mm): 160  
 Diameter (in): 6 <sup>5</sup>/<sub>16</sub>  
 Height (mm): 160  
 Height (in): 6 <sup>5</sup>/<sub>16</sub>  
 Max. Overall Height (mm): 2160  
 Max. Overall Height (in): 85 <sup>7</sup>/<sub>16</sub>  
 Weight (kg): 0.900  
 Weight (lbs): 1.98  
 Diffuser: Glass - Opal  
 Fixture Finish: [AMB / GRN / MBK / PNK / RUB / SKB / SMK / TOB / TRA](#)  
 Holder Finish: CHR / WHI / BLK / BCR  
 Fixture Material: Glass / Metal  
 Primary Material: Glass - Borosilicate  
 Cable Details: 2000mm / 78 3/4" - Transparent Cable  
 Upon Request: On Demand Holder Finishes - Satin Gold, Satin Bronze or Satin Black Nickel

#### ELECTRICAL

Lamp Type: LED  
 Input Wattage (W): 7.8  
 Total Output Wattage (W): 6  
 Dimming: Non-Dimmable  
 Driver Included: Yes  
 Driver Location: Integrated  
 Driver Type: Constant Current - Universal  
 Driver Class: Class 2  
 Input Voltage (V): 120  
 Constant Current (mA): 500  
 Upon Request: Non-Dimming / Phase Dimming (120Vac only) / 0-10V Dimming

#### LED

Color Temperature (°K): 3000  
 Max. Delivered Lumen (lm): 866  
 Nominal Lumen (lm): 886  
 CRI: >90 CRI

#### OPTICAL

#### RATINGS AND CERTIFICATIONS

Certified By: Certified for North American Standards  
 IP rating: IP20

PROJECT
TYPE
SPECIFIER
QUANTITY
DATE

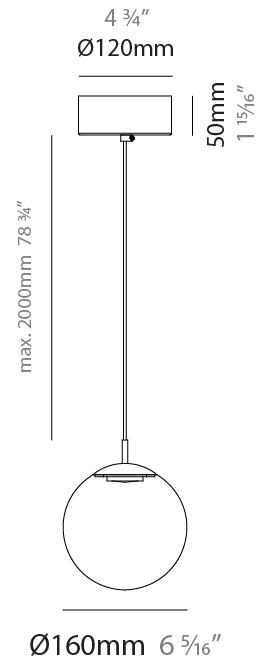

## PIT - MONOPOINT SUSPENSION

D141232-

PROJECT	_____
TYPE	_____
SPECIFIER	_____
QUANTITY	_____
DATE	_____

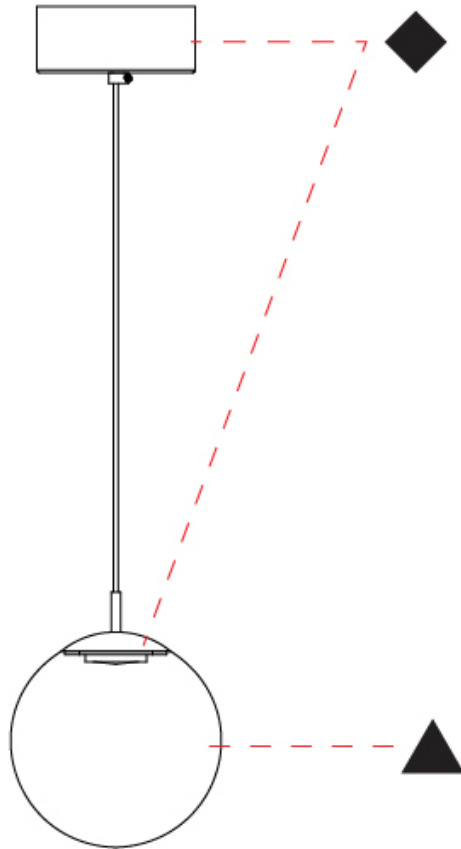

D

## PIT - MONOPOINT SUSPENSION

### D141233-

base number      Finish Options      -      Finish Options

- To build a product code in our configurator select the specify button on the base model # product page
- To build a manual product code on this datasheet choose from the options listed below in blue font and add the suffix to the base model #

#### GENERAL

Series: Pit  
 Subseries: Pit - Monopoint  
 Partner: Cangini & Tucci  
 Division: Design  
 Installation: Suspension  
 Product Type: Pendant  
 Mounting Location: Ceiling

#### PHYSICAL

Shape: Sphere  
 Diameter (mm): 180  
 Diameter (in): 7 1/16  
 Height (mm): 180  
 Height (in): 7 1/16  
 Max. Overall Height (mm): 2180  
 Max. Overall Height (in): 85 13/16  
 Weight (kg): 0.900  
 Weight (lbs): 1.98  
 Diffuser: Glass - Opal  
 Fixture Finish: [AMB / GRN / MBK / PNK / RUB / SKB / SMK / TOB / TRA](#)  
 Holder Finish: CHR / WHI / BLK / BCR  
 Fixture Material: Glass / Metal  
 Primary Material: Glass - Borosilicate  
 Cable Details: 2000mm / 78 3/4" - Transparent Cable  
 Upon Request: On Demand Holder Finishes - Satin Gold, Satin Bronze or Satin Black Nickel

#### ELECTRICAL

Lamp Type: LED  
 Input Wattage (W): 7.8  
 Total Output Wattage (W): 6  
 Dimming: Non-Dimmable  
 Driver Included: Yes  
 Driver Location: Integrated  
 Driver Type: Constant Current - Universal  
 Driver Class: Class 2  
 Input Voltage (V): 120  
 Constant Current (mA): 500  
 Upon Request: Non-Dimming / Phase Dimming (120Vac only) / 0-10V Dimming

#### LED

Color Temperature (°K): 3000  
 Max. Delivered Lumen (lm): 866  
 Nominal Lumen (lm): 886  
 CRI: >90 CRI

#### OPTICAL

#### RATINGS AND CERTIFICATIONS

Certified By: Certified for North American Standards  
 IP rating: IP20

PROJECT
TYPE
SPECIFIER
QUANTITY
DATE

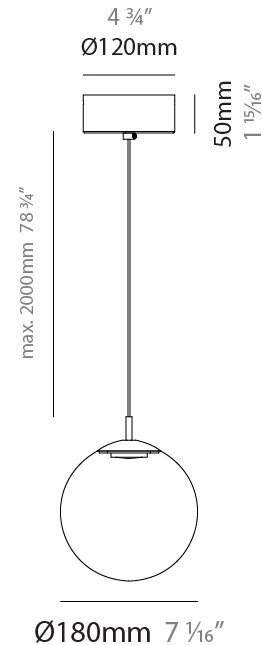

## PIT - MONOPOINT SUSPENSION

D141233-

PROJECT \_\_\_\_\_

TYPE \_\_\_\_\_

SPECIFIER \_\_\_\_\_

QUANTITY \_\_\_\_\_

DATE \_\_\_\_\_

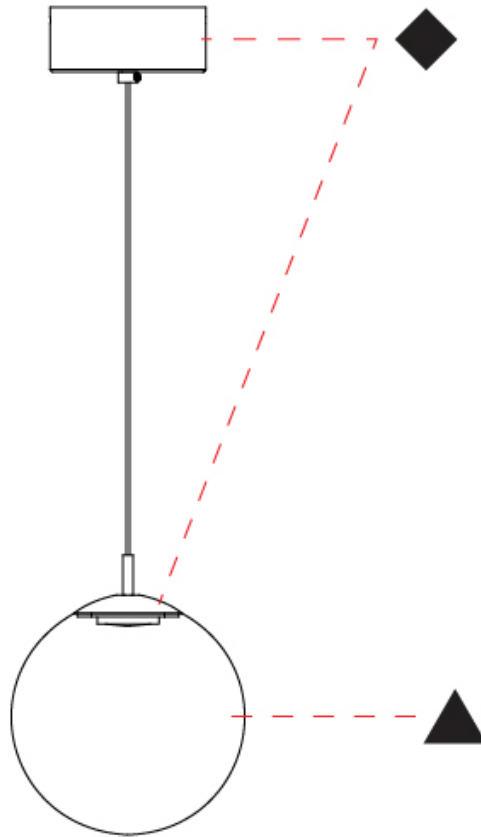

D

## PIT - MODULAR SUSPENSION SUSPENSION

### D141290-

base number      Finish      Finish  
 Options            Options

- To build a product code in our configurator select the specify button on the base model # product page
- To build a manual product code on this datasheet choose from the options listed below in blue font and add the suffix to the base model #

#### GENERAL

Series: Pit  
 Subseries: Pit - Modular Suspension  
 Partner: Cangini & Tucci  
 Division: Design  
 Installation: Suspension  
 Product Type: Pendant  
 Mounting Location: Ceiling

#### PHYSICAL

Shape: Sphere  
 Diameter (mm): 180  
 Diameter (in): 7 1/16  
 Height (mm): 180  
 Height (in): 7 1/16  
 Max. Overall Height (mm): 2180  
 Max. Overall Height (in): 85 13/16  
 Weight (kg): 0.900  
 Weight (lbs): 1.98  
 Diffuser: Glass - Opal  
 Fixture Finish: [AMB / GRN / MBK / PNK / RUB / SKB / SMK / TOB / TRA](#)  
 Holder Finish: CHR / WHI / BLK / BCR  
 Fixture Material: Glass / Metal  
 Primary Material: Glass - Borosilicate  
 Cable Details: 2000mm / 78 3/4" - Transparent Cable  
 Upon Request: On Demand Holder Finishes - Satin Gold, Satin Bronze or Satin Black Nickel

#### ELECTRICAL

Lamp Type: LED  
 Input Wattage (W): 7.8  
 Total Output Wattage (W): 6  
 Dimming: Non-Dimmable  
 Driver Included: Yes  
 Driver Location: Integrated  
 Driver Type: Constant Current - Universal  
 Driver Class: Class 2  
 Input Voltage (V): 120  
 Constant Current (MA): 500  
 Upon Request: Non-Dimming / Phase Dimming (120Vac only) / 0-10V Dimming

#### LED

Color Temperature (°K): 3000  
 Max. Delivered Lumen (lm): 866  
 Nominal Lumen (lm): 886  
 CRI: >90 CRI

#### OPTICAL

#### RATINGS AND CERTIFICATIONS

Certified By: Certified for North American Standards  
 IP rating: IP20

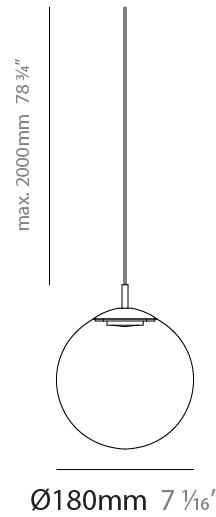

## PIT - MODULAR SUSPENSION SUSPENSION

D141290-

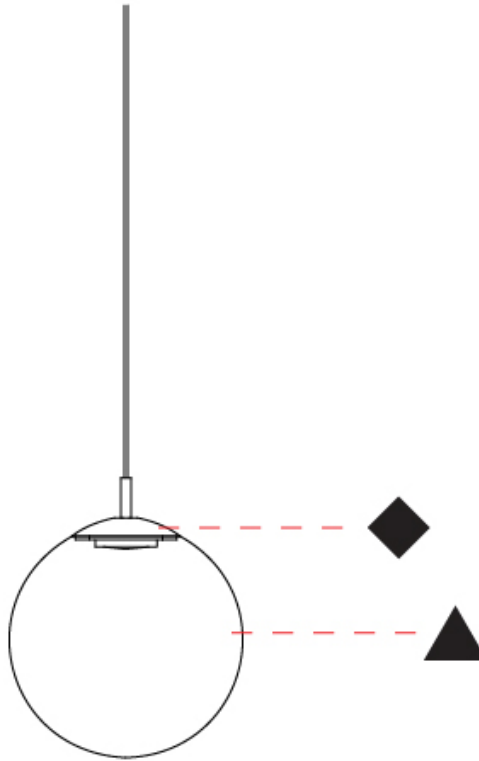

D

## PIT - MODULAR SUSPENSION SUSPENSION

### D14PIT-MOD-SYS

base number

1. To build a product code in our configurator select the specify button on the base model # product page
2. To build a manual product code on this datasheet choose from the options listed below in blue font and add the suffix to the base model #

#### GENERAL

Series: Pit \_\_\_\_\_  
Subseries: Pit - Modular Suspension \_\_\_\_\_  
Partner: Cangini & Tucci \_\_\_\_\_  
Division: Design \_\_\_\_\_  
Installation: Suspension \_\_\_\_\_  
Product Type: Clusters \_\_\_\_\_  
Mounting Location: Ceiling \_\_\_\_\_

#### PHYSICAL

#### ELECTRICAL

Lamp Type: LED \_\_\_\_\_

#### LED

#### OPTICAL

#### RATINGS AND CERTIFICATIONS

Certified By: Certified for North American Standards \_\_\_\_\_  
IP rating: IP20 \_\_\_\_\_



PROJECT \_\_\_\_\_  
 TYPE \_\_\_\_\_  
 SPECIFIER \_\_\_\_\_  
 QUANTITY \_\_\_\_\_  
 DATE \_\_\_\_\_

## PIT COLOR FINISH CHART

### Fixture Finish

Amber - AMB



Green - GRN



Matte Black - MBK



Pink - PNK



Ruby - RUB



Sky Blue - SKB



Smoke - SMK



Tobacco - TOB



Transparent - TRA



### Holder Finish

Chrome - CHR



Matte White - MWH

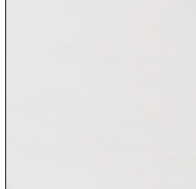

Matte Black - MBK

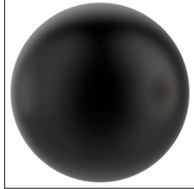

Brushed Chrome - BCR



White - WHI



Black - BLK

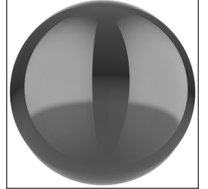

Polished Stainless Steel - PSS



## PIT - 3 LIGHT LINEAR, PIT - MODULAR SUSPENSION, PIT - MONOPOINT, PIT - SUSPENSION 3 LIGHT ROUND SUSPENSION

### COLOR FINISH CHART

#### Accent Finish

Chrome - CHR

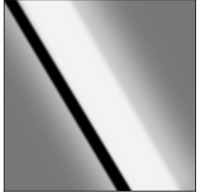

Matte White - MWH



Matte Black - MBK

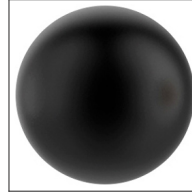

Brushed Chrome - BCR



**Digital:** Not all screens are calibrated the same, and therefore, colors will appear differently between screens.

**Physical:** When texture is involved, there will be variations in color, character and tone within a product series and between product families.



### LEGEND

	floor-mounted		pivotable		special LED (upon request) RGB, RGBW, tunable, gold+, meat+, art+, fashion+
	wall and ceiling: recessed and surface mounted		rotating		warm dim / natural dimming LED
	ceiling-mounted and wall-mounted		illuminate tilted		rechargeable battery powered
	wall-mounted		color of suspension cable		fixture with natural vivid LED (upon request)
	omni-directional light distribution		length of suspension cable		color rendering index
	direct light distribution		reflector degree selection		color temperature
	direct/indirect light distribution		super spot		lumen (luminous flux)
	indirect light distribution		lens		efficacy (lumens per watt)
	asymmetric light distribution		lens pack		Unified Glare Rating (UGR) range from 5-40
	aura light distribution		shine ring		marine grade (AISI 316 stainless steel)
	round wall or ceiling cut-out		integrated shine ring with diffuser		walk on
	square wall or ceiling cut-out		free individual colors 01-29		drive on
	the supplied jig specifies the cutout dimensions		individual colors: 00 (free of charge), 01-25 (extra charge)		Dark Sky Compliance
	minimum distance (meters) lamp - object		luminaire part to be colored (F1)		Americans with Disabilities Act (less than 4" off the wall located between 27"-84" from floor)
	recessed depth		luminaire part to be colored (F2)		lamp protected against explosion
	ceiling thickness in mm		luminaire part to be colored (F3)		blown glass using traditional methods by master glass blower
	ceiling thickness selection		luminaire part to be colored (F4)		acoustic material
	dimmable DP (phase), DV (0-10V), DD (dali), DS (step-dim)		luminaire part to be colored (F5)		protection class I, protection insulation
	included or excluded LED driver/transformer/control gear		color of 3-circuit adaptor		protection class II, protection insulation
	separately switchable		indirect diffuser		ETL Certified to UL and CSA Standards
	sensor		direct diffuser		UL Certified to UL and CSA Standards
	remote control		ball-proof (upon request)		CSA Certified to UL and CSA Standards
	available upon request		accessory		Certified for North American Standards

### IP RATING

	protected against ingress of solid bodies greater than 12.5mm (finger)
	protected against ingress of solid bodies greater than 2.5mm protected against sprays of water up to 60 degrees from the vertical (rain)
	protected against ingress of solid bodies greater than 1mm (wire) no protection against the ingress of moisture
	protected against ingress of solid bodies greater than 1mm (wire) protected against sprays of water up to 60 degrees from the vertical (rain)
	protected against ingress of solid bodies greater than 1mm (wire) protected against water splashed from all directions
	protected against limited ingress of dust (wet rooms/covered outdoor areas) protected against water splashed from all directions
	protected against ingress of dust protected against jets of water
	protected against ingress of dust protected against powerful jets of water or heavy seas
	protected against ingress of dust protected against immersion of water between 15cm - 1m for 30 minutes
	protected against ingress of dust protected against immersion of water under pressure for long periods

### IK RATING

	protected against 0.14 joules impact (equivalent to 0.25kg mass dropped from 56mm above the surface)
	protected against 0.2 joules impact (equivalent to 0.25kg mass dropped from 80mm above the surface)
	protected against 0.35 joules impact (equivalent to 0.25kg mass dropped from 140mm above the surface)
	protected against 0.5 joules impact (equivalent to 0.25kg mass dropped from 200mm above the surface)
	protected against 0.7 joules impact (equivalent to 0.25kg mass dropped from 280mm above the surface)
	protected against 1 joules impact (equivalent to 0.25kg mass dropped from 400mm above the surface)
	protected against 2 joules impact (equivalent to 0.5kg mass dropped from 400mm above the surface)
	protected against 5 joules impact (equivalent to 1.7kg mass dropped from 300mm above the surface)
	protected against 10 joules impact (equivalent to 5.0kg mass dropped from 200mm above the surface)
	protected against 20 joules impact (equivalent to 5.0kg mass dropped from 400mm above the surface)