

| | |
|-----------|--|
| PROJECT | |
| TYPE | |
| SPECIFIER | |
| QUANTITY | |
| DATE | |

POLARIS SURFACE

D112023

base number

- To build a product code in our configurator select the specify button on the base model # product page
- To build a manual product code on this datasheet choose from the options listed below in blue font and add the suffix to the base model #

GENERAL

Series: Polaris
 Brand: Ole
 Division: Design
 Mounting Type: Surface
 Mounting Location: Wall / Ceiling
 Subcategory: Ambient

PHYSICAL

Shape: Abstract
 Length (mm): 580
 Length (in): 22 ¹³/₁₆
 Width (mm): 580
 Width (in): 22 ¹³/₁₆
 Height (mm): 80
 Height (in): 3 ¹/₈
 Light Distribution: Omnidirectional
 Weight (kg): 2.7
 Weight (lbs): 5.9
 Diffuser: Elastic Fabric - Optical White
 Fixture Finish: WHI
 Fixture Material: Metal / Elastic Fabric

ELECTRICAL

Number of Lamps: 4
 Lamp Type: LED Retrofit
 Lamp Shape: A19
 Bulb Included: Bulb Not Included
 Max. Wattage Per Lamp (W): 15
 Lamp Base: E26
 Input Voltage (V): 120
 Upon Request: 277Vac / GU24

LED

OPTICAL

RATINGS AND CERTIFICATIONS

Certified By: Certified for North American Standards
 IP rating: IP20

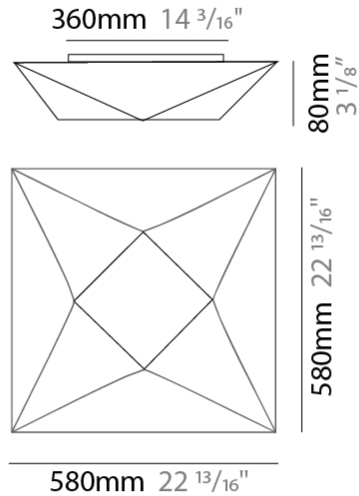
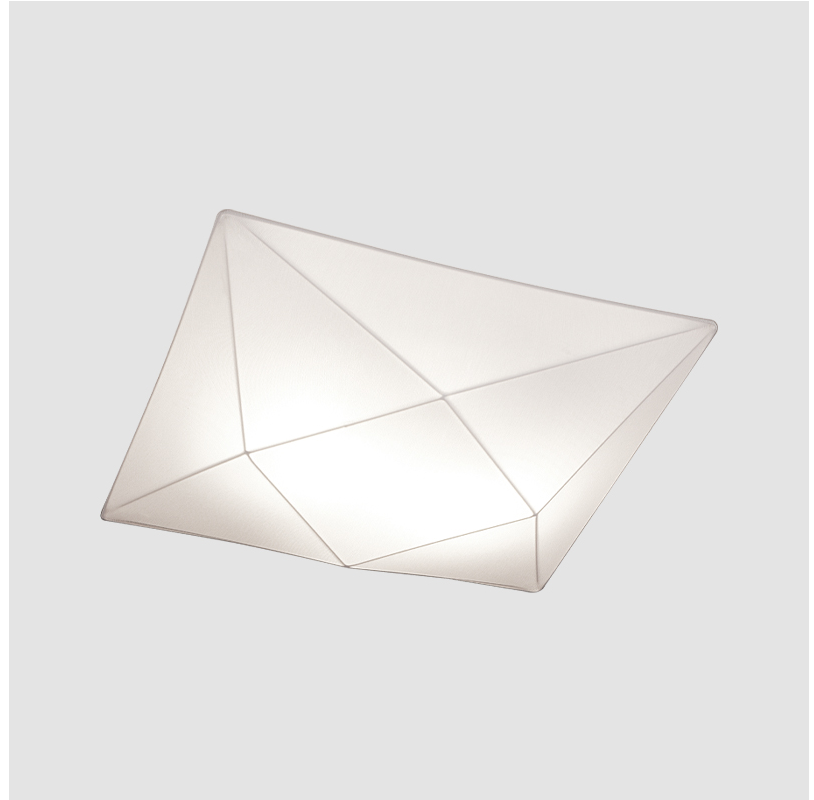

D112023

| | |
|-----------|-------|
| PROJECT | _____ |
| TYPE | _____ |
| SPECIFIER | _____ |
| QUANTITY | _____ |
| DATE | _____ |

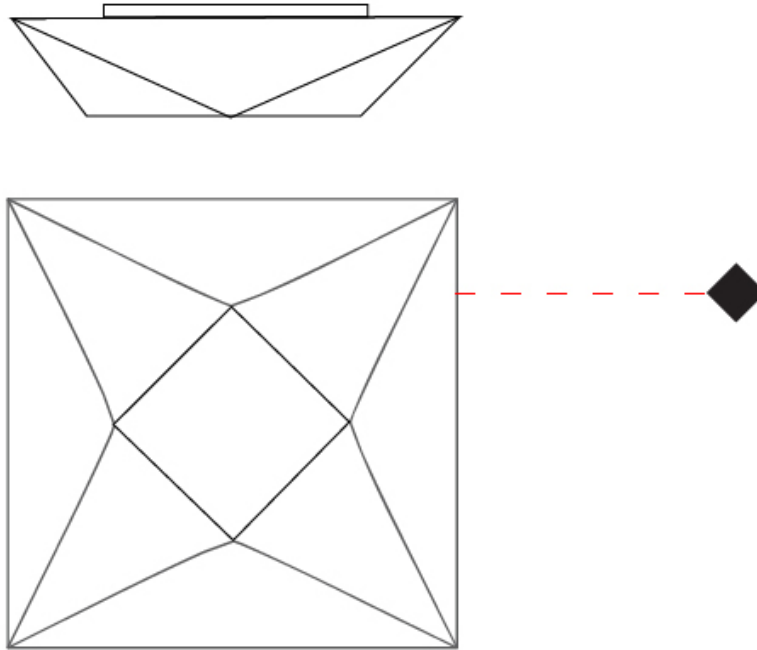

| | |
|-----------|--|
| PROJECT | |
| TYPE | |
| SPECIFIER | |
| QUANTITY | |
| DATE | |

POLARIS SURFACE

D113028

base number

- To build a product code in our configurator select the specify button on the base model # product page
- To build a manual product code on this datasheet choose from the options listed below in blue font and add the suffix to the base model #

GENERAL

Series: Polaris
 Brand: Ole
 Division: Design
 Mounting Type: Surface
 Mounting Location: Wall
 Subcategory: Ambient

PHYSICAL

Shape: Abstract
 Length (mm): 580
 Length (in): 22 ¹³/₁₆
 Width (mm): 150
 Width (in): 5 ⁷/₈
 Height (mm): 100
 Height (in): 3 ¹⁵/₁₆
 Extension (mm): 100
 Extension (in): 3 ¹⁵/₁₆
 Light Distribution: Omnidirectional
 Weight (kg): 1.3
 Weight (lbs): 2.9
 Diffuser: Elastic Fabric - Optical White
 Fixture Finish: WHI
 Fixture Material: Metal / Elastic Fabric

ELECTRICAL

Number of Lamps: 2
 Lamp Type: LED Retrofit
 Lamp Shape: A19
 Bulb Included: Bulb Not Included
 Max. Wattage Per Lamp (W): 15
 Lamp Base: E26
 Input Voltage (V): 120
 Upon Request: 277Vac / GU24

LED

OPTICAL

RATINGS AND CERTIFICATIONS

Certified By: Certified for North American Standards
 IP rating: IP20

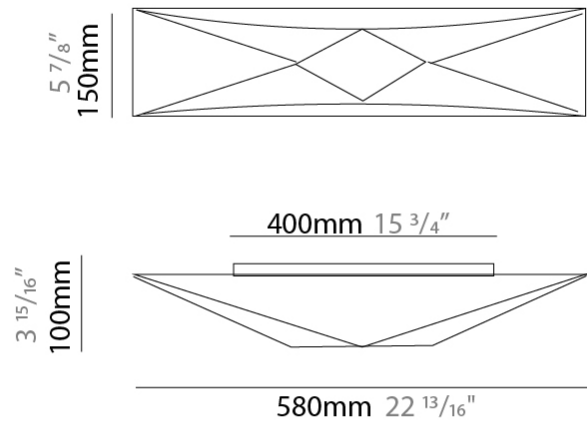
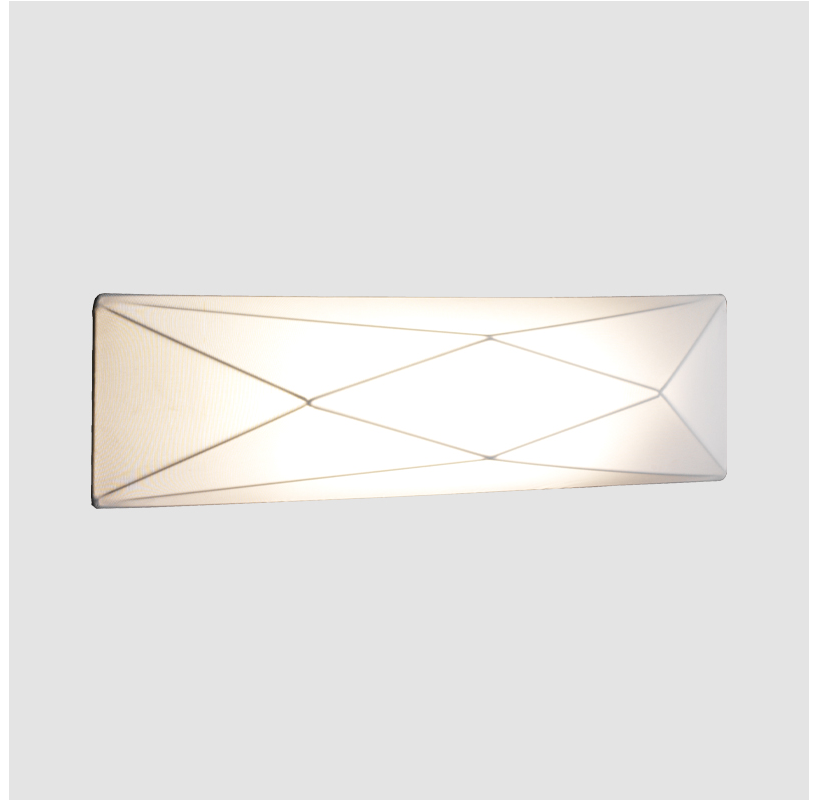

D113028

| | |
|-----------|-------|
| PROJECT | _____ |
| TYPE | _____ |
| SPECIFIER | _____ |
| QUANTITY | _____ |
| DATE | _____ |

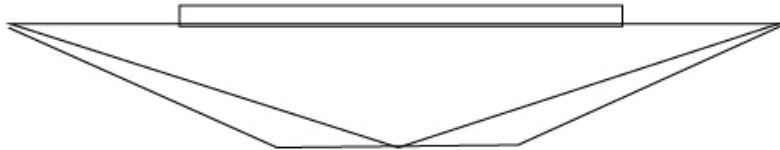
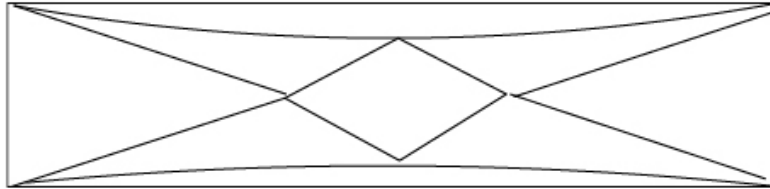

PROJECT

TYPE

SPECIFIER

QUANTITY

DATE

Fixture Finish

White - WHI



Digital: Not all screens are calibrated the same, and therefore, colors will appear differently between screens.

Physical: When texture is involved, there will be variations in color, character and tone within a product series and between product families.



COLOR FINISH CHART



Digital: Not all screens are calibrated the same, and therefore, colors will appear differently between screens.
Physical: When texture is involved, there will be variations in color, character and tone within a product series and between product families.

COMPLETE COLOR FINISH CHART

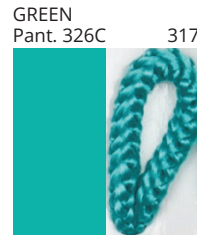
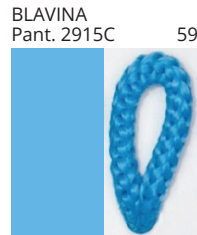
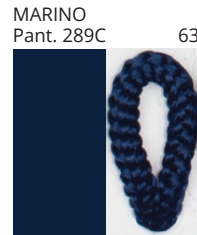
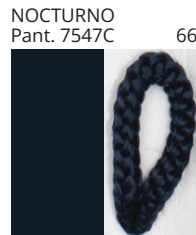
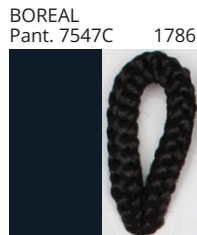
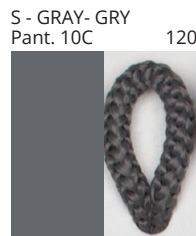
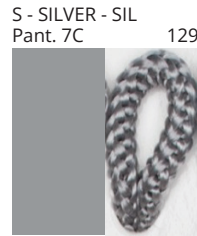
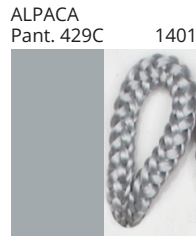

Standard Colors with [S-]

Other fabric cord colors available upon request. Price increase and minimum quantities may apply

Digital: Not all screens are calibrated the same, and therefore, colors will appear differently between screens.

Physical: When texture is involved, there will be variations in color, character and tone within a product series and between product families.

Zaneen Group Inc. © 2024, T 1800-388-3382, F 416-247-9319, www.zaneen.com

Available for International specifications by adding 'INT' at the end of the existing Model #. For assistance on 'custom' specifications, contact zteam@zaneen.com.

In a constant effort to supply the best product, we reserve the right to change specifications or materials without notice. The most recent specification sheets are found at zaneen.com

COMPLETE COLOR FINISH CHART

JADE
 Pant. 3268C 311



VERDE BILLAR
 Pant. 340C 353



JUNGLA
 Pant. 356C 310



VERDE OSC.
 Pant. 3298C 358



MUSGO
 Pant. 5535C 320



S - DARK GREEN
 Pant. 5616C 301



S - OLIVE
 Pant. 5625C 323



CIRUELA
 Pant. 368C 104



LAVANDA
 Pant. 374C 2214



CRUDO
 Pant. 7401C 170



OPALE
 Pant. 402 1442



S - STONE - STN
 Pant. 7528C 1196



ASTRACAN
 Pant. 7529C 101



CAMELLO
 Pant. 731C 161



CASTANO
 Pant. 4625C 1674



TABACO
 Pant. 1545C 203



MARRON
 Pant. 476C 187



MARRON SUPER
 Pant. BLACK 4C 189



MADERA
 Pant. 7519C 2183



S - MOCHA
 Pant. 7504C 175



AVELLANA
 Pant. 729C 152



S - BEIGE - BEI
 Pant. 727C 196



ARENA
 Pant. 465C 151



BEIGE / CAMEL
 Pant. 1265C 154



Standard Colors with [S-]

Other fabric cord colors available upon request. Price increase and minimum quantities may apply

Digital: Not all screens are calibrated the same, and therefore, colors will appear differently between screens.

Physical: When texture is involved, there will be variations in color, character and tone within a product series and between product families.

Zaneen Group Inc. © 2024, T 1800-388-3382, F 416-247-9319, www.zaneen.com

Available for International specifications by adding 'INT' at the end of the existing Model #. For assistance on 'custom' specifications, contact zteam@zaneen.com.

In a constant effort to supply the best product, we reserve the right to change specifications or materials without notice. The most recent specification sheets are found at zaneen.com

COMPLETE COLOR FINISH CHART

ORO
Pant. 872C 16



GOLDEN
Pant. 7403C 7



S - MUSTARD
Pant. 1245C 168



CANARIO
Pant. 106C 9



MIMOSA
Pant. 108C 15



AMARILLO
Pant. 109U 1



NECTAR
Pant. 137C 1871



LAVA
Pant. 151C 1334



NARANJA
Pant. 164C 87



S - TERRACOTTA
Pant. 153C 205



CALABAZA
Pant. 158C 84



ARCILLA
Pant. 1675C 150



ROJO
Pant. 186C 241



FUEGO
Pant. 185C 245



SATAN
Pant. 207C 19



S - MAROON
Pant. 1955C 224



CLARETE
Pant. 209C 240



BURDEOS
Pant. 188C 163



RUBINA
Pant. 229C 285



FRESILLA
Pant. 695C 273



PURPURA
Pant. 215C 276



CICLAMOR
Pant. 205C 264



FUCSIA
Pant. 212C 267



PESCA
Pant. 218C 275



Standard Colors with [S-]

Other fabric cord colors available upon request. Price increase and minimum quantities may apply

Digital: Not all screens are calibrated the same, and therefore, colors will appear differently between screens.

Physical: When texture is involved, there will be variations in color, character and tone within a product series and between product families.

Zaneen Group Inc. © 2024, T 1800-388-3382, F 416-247-9319, www.zaneen.com

Available for International specifications by adding 'INT' at the end of the existing Model #. For assistance on 'custom' specifications, contact zteam@zaneen.com.

In a constant effort to supply the best product, we reserve the right to change specifications or materials without notice. The most recent specification sheets are found at zaneen.com

PROJECT _____
TYPE _____
NOTES _____
QUANTITY _____
DATE _____

COMPLETE COLOR FINISH CHART

ROSA PASTEL
Pant. 1905C 281



ALEJANDRIA
Pant. 196C 261



CANET
Pant. 2717C 43



MALVA
Pant. 2567C 141



AMORATADO
Pant. 265C 135



LAPIZLAZULI
Pant. 2745C 62



VIOLETA
Pant. 7676C 147



Standard Colors with [S-]

Other fabric cord colors available upon request. Price increase and minimum quantities may apply

Digital: Not all screens are calibrated the same, and therefore, colors will appear differently between screens.

Physical: When texture is involved, there will be variations in color, character and tone within a product series and between product families.

Zaneen Group Inc. © 2024, T 1800-388-3382, F 416-247-9319, www.zaneen.com

Available for International specifications by adding 'INT' at the end of the existing Model #. For assistance on 'custom' specifications, contact zteam@zaneen.com.

In a constant effort to supply the best product, we reserve the right to change specifications or materials without notice. The most recent specification sheets are found at zaneen.com

| | |
|-----------|--|
| PROJECT | |
| TYPE | |
| SPECIFIER | |
| QUANTITY | |
| DATE | |

LEGEND

| | | | | | |
|--|---|--|--|--|--|
| | floor-mounted | | pivotal | | special LED (upon request) RGB, RGBW, tunable, gold+, meat+, art+, fashion+ |
| | wall and ceiling: recessed and surface mounted | | rotating | | warm dim / natural dimming LED |
| | ceiling-mounted and wall-mounted | | illuminate tilted | | rechargeable battery powered |
| | wall-mounted | | color of suspension cable | | fixture with natural vivid LED (upon request) |
| | omni-directional light distribution | | length of suspension cable | | color rendering index |
| | direct light distribution | | reflector degree selection | | color temperature |
| | direct/indirect light distribution | | super spot | | lumen (luminous flux) |
| | indirect light distribution | | lens | | efficacy (lumens per watt) |
| | asymmetric light distribution | | lens pack | | Unified Glare Rating (UGR) range from 5-40 |
| | aura light distribution | | shine ring | | marine grade (AISI 316 stainless steel) |
| | round wall or ceiling cut-out | | integrated shine ring with diffuser | | walk on |
| | square wall or ceiling cut-out | | free individual colors 01-29 | | drive on |
| | the supplied jig specifies the cutout dimensions | | individual colors: 00 (free of charge), 01-25 (extra charge) | | Dark Sky Compliance |
| | minimum distance (meters) lamp - object | | luminaire part to be colored (F1) | | Americans with Disabilities Act (less than 4" off the wall located between 27"-84" from floor) |
| | recessed depth | | luminaire part to be colored (F2) | | lamp protected against explosion |
| | ceiling thickness in mm | | luminaire part to be colored (F3) | | blown glass using traditional methods by master glass blower |
| | ceiling thickness selection | | luminaire part to be colored (F4) | | acoustic material |
| | dimnable DP (phase), DV (0-10V), DD (dali), DS (step-dim) | | luminaire part to be colored (F5) | | protection class I, protection insulation |
| | included or excluded LED driver/transformer/control gear | | color of 3-circuit adaptor | | protection class II, protection insulation |
| | separately switchable | | indirect diffuser | | ETL Certified to UL and CSA Standards |
| | sensor | | direct diffuser | | UL Certified to UL and CSA Standards |
| | remote control | | ball-proof (upon request) | | CSA Certified to UL and CSA Standards |
| | available upon request | | accessory | | Certified for North American Standards |

IP RATING

| | |
|--|--|
| | protected against ingress of solid bodies greater than 12.5mm (finger) |
| | protected against ingress of solid bodies greater than 2.5mm protected against sprays of water up to 60 degrees from the vertical (rain) |
| | protected against ingress of solid bodies greater than 1mm (wire) no protection against the ingress of moisture |
| | protected against ingress of solid bodies greater than 1mm (wire) protected against sprays of water up to 60 degrees from the vertical (rain) |
| | protected against ingress of solid bodies greater than 1mm (wire) protected against water splashed from all directions |
| | protected against limited ingress of dust (wet rooms/covered outdoor areas) protected against water splashed from all directions |
| | protected against ingress of dust protected against jets of water |
| | protected against ingress of dust protected against powerful jets of water or heavy seas |
| | protected against ingress of dust protected against immersion of water between 15cm - 1m for 30 minutes |
| | protected against ingress of dust protected against immersion of water under pressure for long periods |

IK RATING

| | |
|--|---|
| | protected against 0.14 joules impact (equivalent to 0.25kg mass dropped from 56mm above the surface) |
| | protected against 0.2 joules impact (equivalent to 0.25kg mass dropped from 80mm above the surface) |
| | protected against 0.35 joules impact (equivalent to 0.25kg mass dropped from 140mm above the surface) |
| | protected against 0.5 joules impact (equivalent to 0.25kg mass dropped from 200mm above the surface) |
| | protected against 0.7 joules impact (equivalent to 0.25kg mass dropped from 280mm above the surface) |
| | protected against 1 joules impact (equivalent to 0.25kg mass dropped from 400mm above the surface) |
| | protected against 2 joules impact (equivalent to 0.5kg mass dropped from 400mm above the surface) |
| | protected against 5 joules impact (equivalent to 1.7kg mass dropped from 300mm above the surface) |
| | protected against 10 joules impact (equivalent to 5.0kg mass dropped from 200mm above the surface) |
| | protected against 20 joules impact (equivalent to 5.0kg mass dropped from 400mm above the surface) |