

| | |
|-----------|-------|
| PROJECT | _____ |
| TYPE | _____ |
| SPECIFIER | _____ |
| QUANTITY | _____ |
| DATE | _____ |

POLARIS SUSPENSION

D111072

base number

- To build a product code in our configurator select the specify button on the base model # product page
- To build a manual product code on this datasheet choose from the options listed below in blue font and add the suffix to the base model #

GENERAL

Series: Polaris
 Partner: Ole
 Division: Design
 Installation: Suspension
 Product Type: Pendant
 Mounting Location: Ceiling

PHYSICAL

Shape: Abstract
 Length (mm): 800
 Length (in): 31 1/2
 Width (mm): 800
 Width (in): 31 1/2
 Height (mm): 250
 Height (in): 9 13/16
 Max. Overall Height (mm): 1370
 Max. Overall Height (in): 53 7/8
 Weight (kg): 4.8
 Weight (lbs): 10.56
 Diffuser: Elastic Fabric - Optical White
 Fixture Finish: WHI
 Fixture Material: Metal / Elastic Fabric
 Primary Material: Fabric
 Cable Details: 2000mm Cable

ELECTRICAL

Number of Lamps: 4
 Lamp Type: LED Retrofit
 Lamp Shape: A19
 Bulb Included: Bulb Not Included
 Max. Wattage Per Lamp (W): 15
 Lamp Base: E26
 Input Voltage (V): 120
 Upon Request: 277Vac / GU24

LED

OPTICAL

RATINGS AND CERTIFICATIONS

Certified By: Certified for North American Standards
 IP rating: IP20

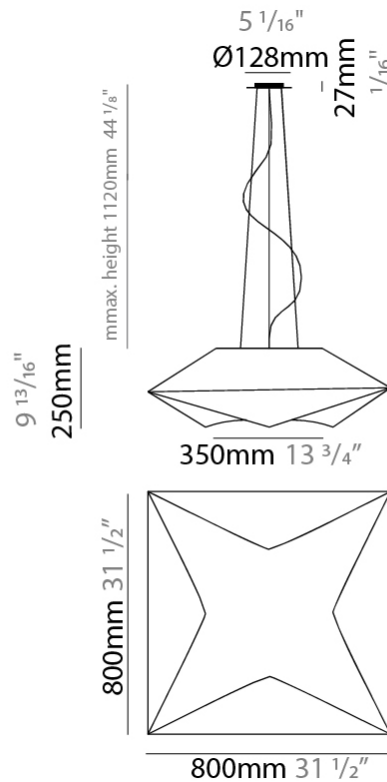

D111072

PROJECT

TYPE

SPECIFIER

QUANTITY

DATE

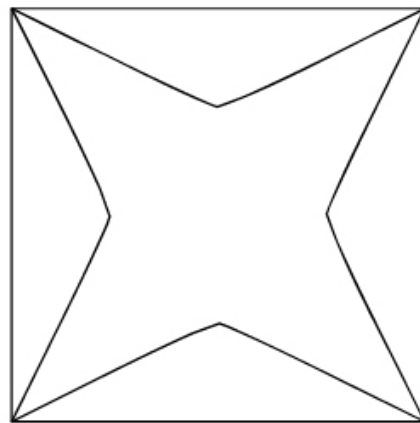
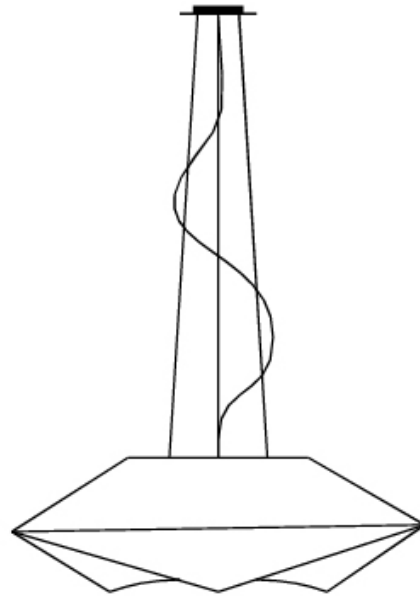

D

POLARIS SUSPENSION

D111072-277V

base number

- To build a product code in our configurator select the specify button on the base model # product page
- To build a manual product code on this datasheet choose from the options listed below in blue font and add the suffix to the base model #

GENERAL

Series: Polaris
 Partner: Ole
 Division: Design
 Installation: Suspension
 Product Type: Pendant
 Mounting Location: Ceiling

PHYSICAL

Shape: Abstract
 Length (mm): 800
 Length (in): 31 1/2
 Width (mm): 800
 Width (in): 31 1/2
 Height (mm): 250
 Height (in): 9 13/16
 Max. Overall Height (mm): 1370
 Max. Overall Height (in): 53 7/8
 Weight (kg): 4.8
 Weight (lbs): 10.56
 Diffuser: Elastic Fabric - Optical White
 Fixture Finish: WHI
 Fixture Material: Metal / Elastic Fabric
 Primary Material: Fabric
 Cable Details: 2000mm Cable

ELECTRICAL

Number of Lamps: 4
 Lamp Type: LED Retrofit
 Lamp Shape: A19
 Bulb Included: Bulb Not Included
 Max. Wattage Per Lamp (W): 15
 Lamp Base: E26
 Input Voltage (V): 120
 Upon Request: 277Vac / GU24

LED

OPTICAL

RATINGS AND CERTIFICATIONS

Certified By: Certified for North American Standards
 IP rating: IP20

| | |
|-----------|--|
| PROJECT | |
| TYPE | |
| SPECIFIER | |
| QUANTITY | |
| DATE | |

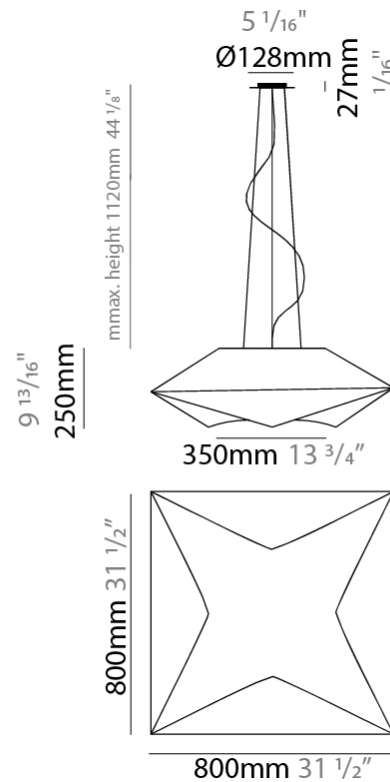

D111072-277V

PROJECT _____

TYPE _____

SPECIFIER _____

QUANTITY _____

DATE _____

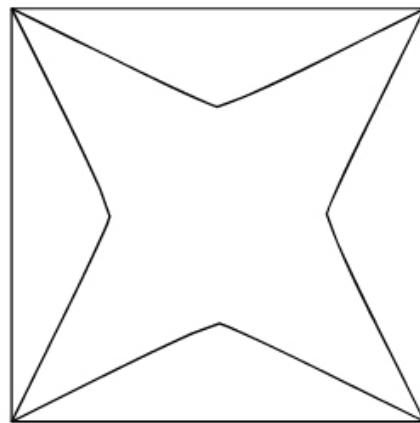
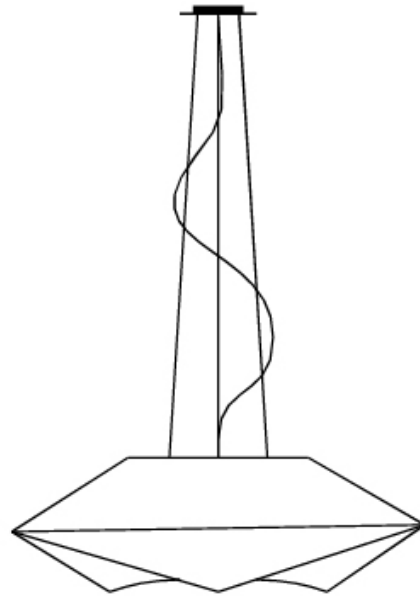

D

POLARIS SURFACE

D112024

base number

| |
|-----------|
| PROJECT |
| TYPE |
| SPECIFIER |
| QUANTITY |
| DATE |

- To build a product code in our configurator select the specify button on the base model # product page
- To build a manual product code on this datasheet choose from the options listed below in blue font and add the suffix to the base model #

GENERAL

Series: Polaris
 Partner: Ole
 Division: Design
 Installation: Surface
 Product Type: Ceiling Surface
 Mounting Location: Ceiling

PHYSICAL

Shape: Abstract
 Length (mm): 800
 Length (in): 31 1/2
 Width (mm): 800
 Width (in): 31 1/2
 Height (mm): 100
 Height (in): 3 15/16
 Weight (kg): 4
 Weight (lbs): 8.8
 Diffuser: Elastic Fabric - Optical White
 Fixture Finish: WHI
 Fixture Material: Metal / Elastic Fabric
 Primary Material: Fabric

ELECTRICAL

Number of Lamps: 4
 Lamp Type: LED Retrofit
 Lamp Shape: A19
 Bulb Included: Bulb Not Included
 Max. Wattage Per Lamp (W): 15
 Lamp Base: E26
 Input Voltage (V): 120
 Upon Request: 277Vac / GU24

LED

OPTICAL

RATINGS AND CERTIFICATIONS

Certified By: Certified for North American Standards
 IP rating: IP20

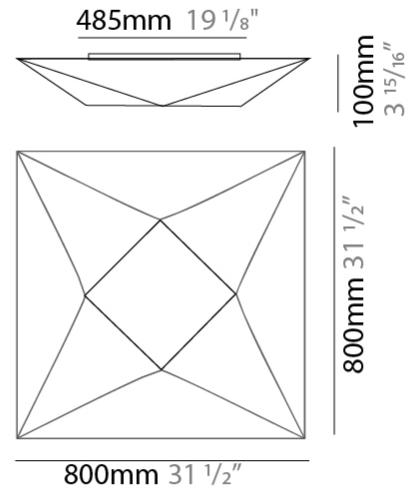
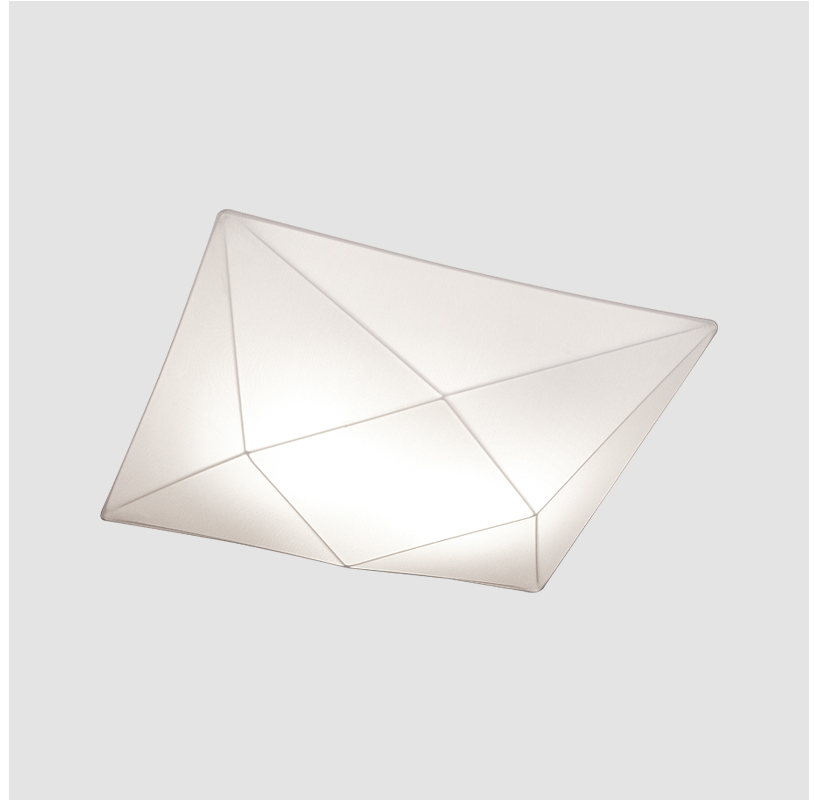

D112024

| | |
|-----------|-------|
| PROJECT | _____ |
| TYPE | _____ |
| SPECIFIER | _____ |
| QUANTITY | _____ |
| DATE | _____ |

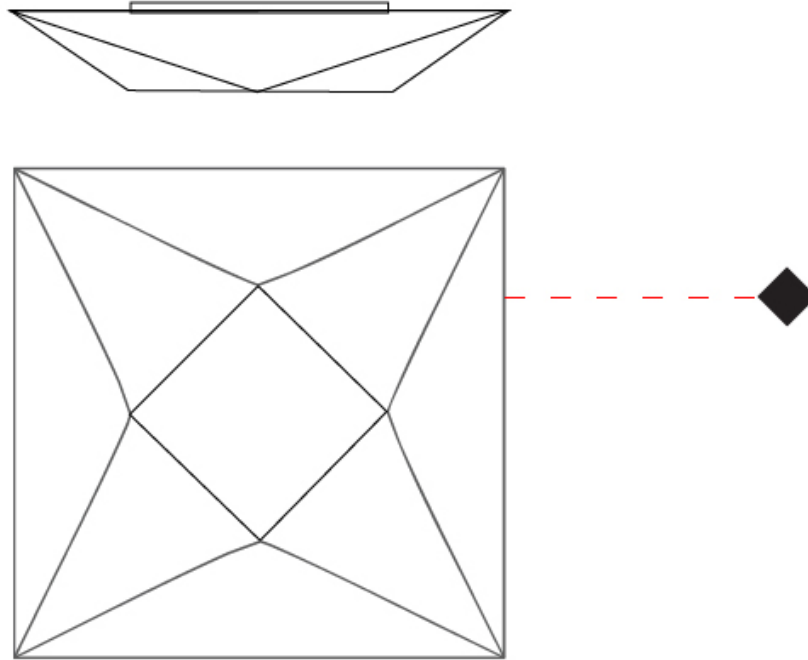

POLARIS COLOR FINISH CHART

PROJECT

TYPE

SPECIFIER

QUANTITY

DATE

Fixture Finish

White - WHI

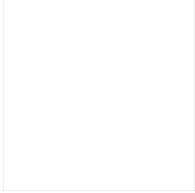

Digital: Not all screens are calibrated the same, and therefore, colors will appear differently between screens.

Physical: When texture is involved, there will be variations in color, character and tone within a product series and between product families.



COMPLETE COLOR FINISH CHART

Standard Colors of Recycles Cords



Sustainable Thin Cord



Standard Colors with [S-]

Other fabric cord colors available upon request. Price increase and minimum quantities may apply

Digital: Not all screens are calibrated the same, and therefore, colors will appear differently between screens.

Physical: When texture is involved, there will be variations in color, character and tone within a product series and between product families.

Zaneen Group Inc. © 2024, T 1800-388-3382, F 416-247-9319, www.zaneen.com

Available for International specifications by adding 'INT' at the end of the existing Model #. For assistance on 'custom' specifications, contact zteam@zaneen.com.

In a constant effort to supply the best product, we reserve the right to change specifications or materials without notice. The most recent specification sheets are found at zaneen.com

COMPLETE COLOR FINISH CHART

Special Colors (for indoor use only)

| | | | | |
|---|---|---|--|--|
| CRISTAL Pant. Glass 75  | Crudo Pant. 7401C 170  | ORO Pant. 872C 16  | GOLDEN Pant. 7403C 7  | AVELLANA Pant. 1955C 152  |
| ALPACA Pant. 429C 1401  | ARENA Pant. 465C 151  | CASTOR Pant. P7530C 167  | TABACO Pant. 1545C 203  | MARRON Pant. 476C 187  |
| TUNEL Pant. Black 7C 169  | BURDEOS Pant. 188C 163  | FRESILLA Pant. 695C 273  | ARCILLA Pant. 1675C 205  | SATAN Pant. 207C 19  |
| MUSGO Pant. 5535C 320  | NOCTURNO Pant. 7547 66  | MEDAS Pant. 295C 168  | LAVA Pant. 151C 1334  | FUEGO Pant. 185C 245  |
| VERDE OSCURO Pant. 3298C 358  | MARINO Pant. 289C 63  | AZUL ELECTRICO Pant. 2945C 168  | CALABAZA Pant. 158C 84  | ROJO Pant. 186C 241  |
| JUNGLA Pant. 356C 310  | AZUL ROYAL Pant. 288C 1075  | VIOLETA Pant. 7676U 147  | AMARILLO Pant. 109U 1  | CICLAMOR Pant. 205C 264  |

Standard Colors with [-]

Other fabric cord colors available upon request. Price increase and minimum quantities may apply

Digital: Not all screens are calibrated the same, and therefore, colors will appear differently between screens.





































































Physical: When texture is involved, there will be variations in color, character and tone within a product series and between product families.

Zaneen Group Inc. © 2024, T 1800-388-3382, F 416-247-9319, www.zaneen.com











Available for International specifications by adding "INT" at the end of the existing Model #. For assistance on 'custom' specifications, contact zteam@zaneen.com.

In a constant effort to supply the best product, we reserve the right to change specifications or materials without notice. The most recent specification sheets are found at zaneen.com











LEGEND

| | | |
|--|--|--|
|  floor-mounted |  pivotable |  special LED (upon request) RGB, RGBW, tunable, gold+, meat+, art+, fashion+ |
|  wall and ceiling: recessed and surface mounted |  rotating |  warm dim / natural dimming LED |
|  ceiling-mounted and wall-mounted |  illuminate tilted |  rechargeable battery powered |
|  wall-mounted |  color of suspension cable |  fixture with natural vivid LED (upon request) |
|  omni-directional light distribution |  length of suspension cable |  color rendering index |
|  direct light distribution |  reflector degree selection |  color temperature |
|  direct/indirect light distribution |  super spot |  lumen (luminous flux) |
|  indirect light distribution |  lens |  efficacy (lumens per watt) |
|  asymmetric light distribution |  lens pack |  Unified Glare Rating (UGR) range from 5-40 |
|  aura light distribution |  shine ring |  marine grade (AISI 316 stainless steel) |
|  round wall or ceiling cut-out |  integrated shine ring with diffuser |  walk on |
|  square wall or ceiling cut-out |  free individual colors 01-29 |  drive on |
|  the supplied jig specifies the cutout dimensions |  individual colors: 00 (free of charge), 01-25 (extra charge) |  Dark Sky Compliance |
|  minimum distance (meters) lamp - object |  luminaire part to be colored (F1) |  Americans with Disabilities Act (less than 4" off the wall located between 27"-84" from floor) |
|  recessed depth |  luminaire part to be colored (F2) |  lamp protected against explosion |
|  ceiling thickness in mm |  luminaire part to be colored (F3) |  blown glass using traditional methods by master glass blower |
|  ceiling thickness selection |  luminaire part to be colored (F4) |  acoustic material |
|  dimmable DP (phase), DV (0-10V), DD (dali), DS (step-dim) |  luminaire part to be colored (F5) |  protection class I, protection insulation |
|  included or excluded LED driver/transformer/control gear |  color of 3-circuit adaptor |  protection class II, protection insulation |
|  separately switchable |  indirect diffuser |  ETL Certified to UL and CSA Standards |
|  sensor |  direct diffuser |  UL Certified to UL and CSA Standards |
|  remote control |  ball-proof (upon request) |  CSA Certified to UL and CSA Standards |
|  available upon request |  accessory |  Certified for North American Standards |

IP RATING

| | |
|--|--|
|  IP20 | protected against ingress of solid bodies greater than 12.5mm (finger) |
|  IP33 | protected against ingress of solid bodies greater than 2.5mm protected against sprays of water up to 60 degrees from the vertical (rain) |
|  IP40 | protected against ingress of solid bodies greater than 1mm (wire) no protection against the ingress of moisture |
|  IP43 | protected against ingress of solid bodies greater than 1mm (wire) protected against sprays of water up to 60 degrees from the vertical (rain) |
|  IP44 | protected against ingress of solid bodies greater than 1mm (wire) protected against water splashed from all directions |
|  IP54 | protected against limited ingress of dust (wet rooms/covered outdoor areas) protected against water splashed from all directions |
|  IP65 | protected against ingress of dust protected against jets of water |
|  IP66 | protected against ingress of dust protected against powerful jets of water or heavy seas |
|  IP67 | protected against ingress of dust protected against immersion of water between 15cm - 1m for 30 minutes |
|  IP68 | protected against ingress of dust protected against immersion of water under pressure for long periods |

IK RATING

| | |
|--|---|
|  IK01 | protected against 0.14 joules impact (equivalent to 0.25kg mass dropped from 56mm above the surface) |
|  IK02 | protected against 0.2 joules impact (equivalent to 0.25kg mass dropped from 80mm above the surface) |
|  IK03 | protected against 0.35 joules impact (equivalent to 0.25kg mass dropped from 140mm above the surface) |
|  IK04 | protected against 0.5 joules impact (equivalent to 0.25kg mass dropped from 200mm above the surface) |
|  IK05 | protected against 0.7 joules impact (equivalent to 0.25kg mass dropped from 280mm above the surface) |
|  IK06 | protected against 1 joules impact (equivalent to 0.25kg mass dropped from 400mm above the surface) |
|  IK07 | protected against 2 joules impact (equivalent to 0.5kg mass dropped from 400mm above the surface) |
|  IK08 | protected against 5 joules impact (equivalent to 1.7kg mass dropped from 300mm above the surface) |
|  IK09 | protected against 10 joules impact (equivalent to 5.0kg mass dropped from 200mm above the surface) |
|  IK10 | protected against 20 joules impact (equivalent to 5.0kg mass dropped from 400mm above the surface) |