

## POLLUX SUSPENSION

### D101837- -

base number      Color      Finish  
                          Temperature      Options

- To build a product code in our configurator select the specify button on the base model # product page
- To build a manual product code on this datasheet choose from the options listed below in blue font and add the suffix to the base model #

#### GENERAL

Series: Pollux  
 Brand: Quasar  
 Division: Design  
 Mounting Type: Suspension  
 Mounting Location: Ceiling  
 Subcategory: Ambient

#### PHYSICAL

Shape: Abstract  
 Length (mm): 2050  
 Length (in): 80 <sup>11</sup>/<sub>16</sub>"  
 Width (mm): 1050  
 Width (in): 41 <sup>5</sup>/<sub>16</sub>"  
 Height (mm): 1870  
 Height (in): 73 <sup>5</sup>/<sub>8</sub>"  
 Light Distribution: Omnidirectional  
 Fixture Finish: [NIC](#) / [BRA](#) / [BBR](#)  
 Fixture Material: Metal  
 Upon Request: Custom Sizes

#### ELECTRICAL

Lamp Type: LED  
 Input Wattage (W): 900  
 Dimming: 0-10V Dimming  
 Driver Included: Yes  
 Driver Location: Integrated  
 Driver Type: Constant Voltage - 120/277Vac  
 Driver Class: Class 2  
 Input Voltage (V): 120 - 277  
 Output Voltage (V): 12

#### LED

Number of LEDs: 1500  
 Color Temperature (°K): [2400](#) / [2800](#)  
 CRI: >90 CRI  
 Lamp Life (hrs): 50000

#### OPTICAL

#### RATINGS AND CERTIFICATIONS

Certified By: Certified for North American Standards  
 IP rating: IP20

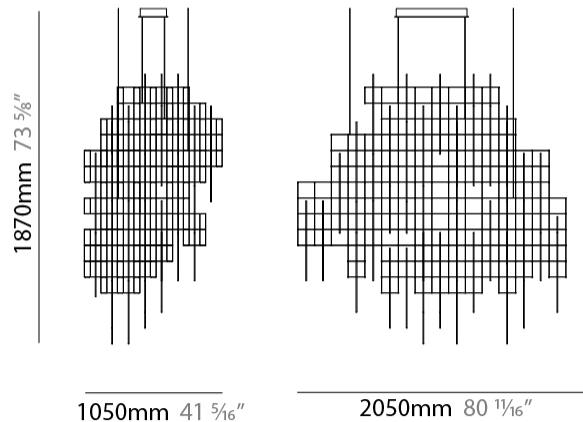
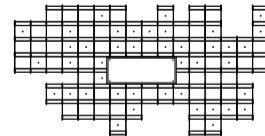

D101837-

PROJECT \_\_\_\_\_

TYPE \_\_\_\_\_

SPECIFIER \_\_\_\_\_

QUANTITY \_\_\_\_\_

DATE \_\_\_\_\_

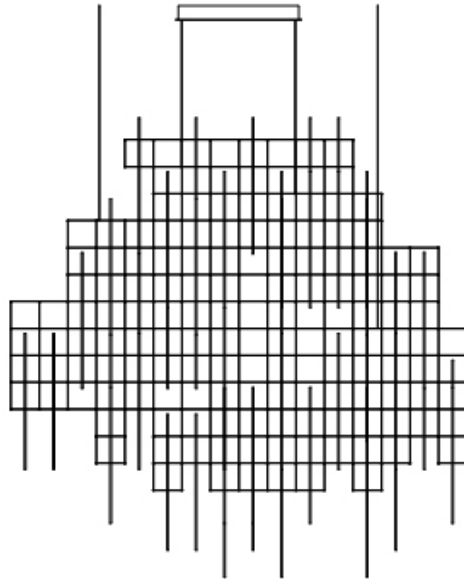
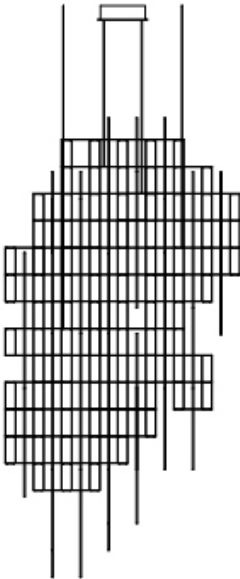
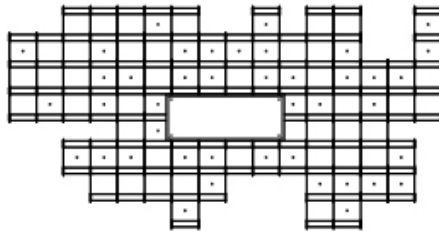

D

## POLLUX SUSPENSION

### D101946- -

base number      Color      Finish  
 Temperature      Options

- To build a product code in our configurator select the specify button on the base model # product page
- To build a manual product code on this datasheet choose from the options listed below in blue font and add the suffix to the base model #

#### GENERAL

Series: Pollux  
 Brand: Quasar  
 Division: Design  
 Mounting Type: Suspension  
 Mounting Location: Ceiling  
 Subcategory: Ambient

#### PHYSICAL

Shape: Abstract  
 Length (mm): 1790  
 Length (in): 70 1/2  
 Width (mm): 1050  
 Width (in): 41 5/16  
 Height (mm): 1080  
 Height (in): 42 1/2  
 Max. Overall Height (mm): 3080  
 Max. Overall Height (in): 121 1/4  
 Light Distribution: Omnidirectional  
 Fixture Finish: [NIC / BRA / BBR](#)  
 Fixture Material: Metal  
 Cable Details: 2000mm Cable  
 Upon Request: Custom Sizes

#### ELECTRICAL

Lamp Type: LED  
 Input Wattage (W): 481.2  
 Dimming: 0-10V Dimming / Phase Dimming (120Vac Only)  
 Driver Included: Yes  
 Driver Location: Integrated  
 Driver Type: Constant Voltage - Universal  
 Driver Class: Class 2  
 Input Voltage (V): 120 - 277  
 Output Voltage (V): 12

#### LED

Number of LEDs: 802  
 Color Temperature (°K): [2400 / 2800](#)  
 Max. Delivered Lumen (lm): 24060 (2800K)  
 CRI: >90 CRI  
 Lamp Life (hrs): 50000

#### OPTICAL

#### RATINGS AND CERTIFICATIONS

Certified By: Certified for North American Standards  
 IP rating: IP20

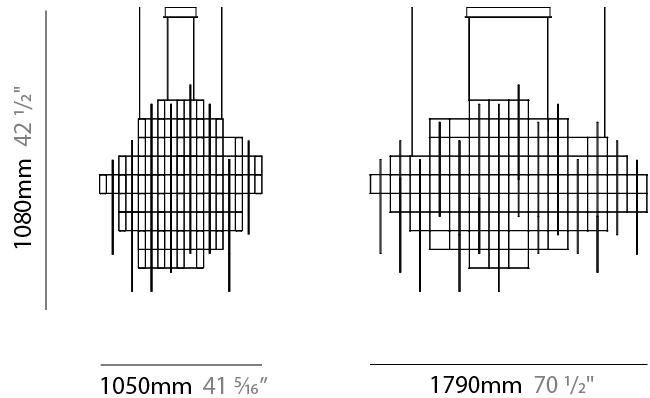
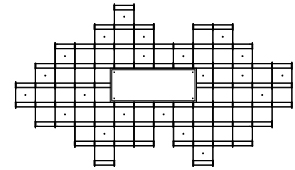

D101946-

PROJECT \_\_\_\_\_

TYPE \_\_\_\_\_

SPECIFIER \_\_\_\_\_

QUANTITY \_\_\_\_\_

DATE \_\_\_\_\_

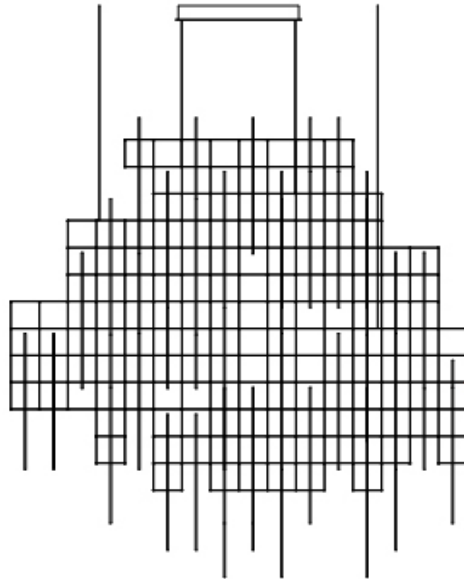
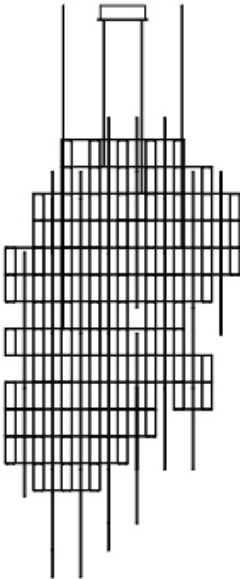
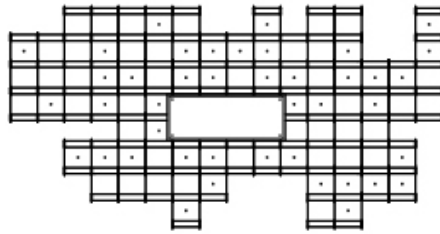

D

## POLLUX SUSPENSION

### D101947- -

base number      Color      Finish  
 Temperature      Options

- To build a product code in our configurator select the specify button on the base model # product page
- To build a manual product code on this datasheet choose from the options listed below in blue font and add the suffix to the base model #

#### GENERAL

Series: Pollux  
 Brand: Quasar  
 Division: Design  
 Mounting Type: Suspension  
 Mounting Location: Ceiling  
 Subcategory: Ambient

#### PHYSICAL

Shape: Abstract  
 Length (mm): 2560  
 Length (in): 100 <sup>13</sup>/<sub>16</sub>  
 Width (mm): 850  
 Width (in): 33 <sup>7</sup>/<sub>16</sub>  
 Height (mm): 1050  
 Height (in): 41 <sup>5</sup>/<sub>16</sub>  
 Max. Overall Height (mm): 3050  
 Max. Overall Height (in): 120 <sup>1</sup>/<sub>16</sub>  
 Light Distribution: Omnidirectional  
 Fixture Finish: [NIC / BRA / BBR](#)  
 Fixture Material: Metal  
 Cable Details: 2000mm Cable  
 Upon Request: Custom Sizes

#### ELECTRICAL

Lamp Type: LED  
 Input Wattage (W): 537  
 Dimming: 0-10V Dimming / Phase Dimming (120Vac Only)  
 Driver Included: Yes  
 Driver Location: Integrated  
 Driver Type: Constant Voltage - Universal  
 Driver Class: Class 2  
 Input Voltage (V): 120 - 277  
 Output Voltage (V): 12

#### LED

Number of LEDs: 895  
 Color Temperature (°K): [2400 / 2800](#)  
 Max. Delivered Lumen (lm): 26850 (2800K)  
 CRI: >90 CRI  
 Lamp Life (hrs): 50000

#### OPTICAL

#### RATINGS AND CERTIFICATIONS

Certified By: Certified for North American Standards  
 IP rating: IP20

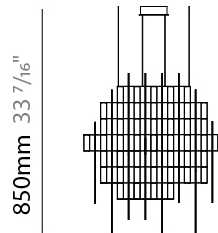
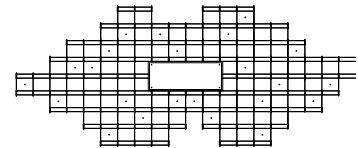

1050mm 41 <sup>5</sup>/<sub>16</sub>"

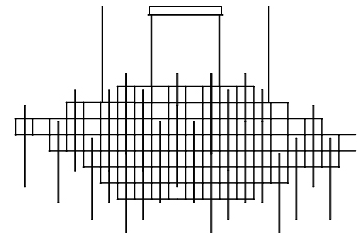

2560mm 100 <sup>13</sup>/<sub>16</sub>"



D101947-

PROJECT

TYPE

SPECIFIER

QUANTITY

DATE

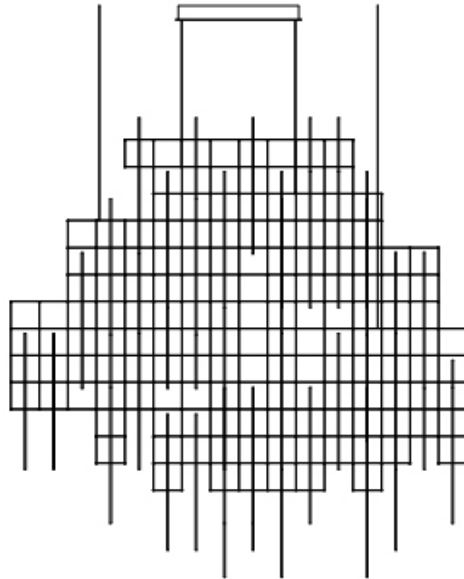
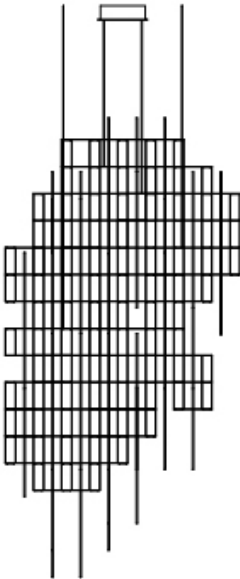
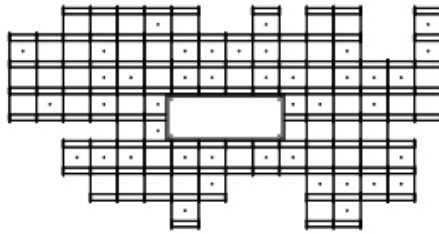

D

|           |       |
|-----------|-------|
| PROJECT   | _____ |
| TYPE      | _____ |
| SPECIFIER | _____ |
| QUANTITY  | _____ |
| DATE      | _____ |

### Fixture Finish

Nickel - NIC



Brass - BRA



Black Brass - BBR



**Digital:** Not all screens are calibrated the same, and therefore, colors will appear differently between screens.

**Physical:** When texture is involved, there will be variations in color, character and tone within a product series and between product families.

Brass, nickel and copper are natural minerals and can potentially change color and show marks over time. We cannot guarantee the color appearance as the material transforms.



### LEGEND

|  |   |   |  |   |  |
|--|---|---|--|---|--|
|    | floor-mounted   |    | pivotal  |    | special LED (upon request) RGB, RGBW, tunable, gold+, meat+, art+, fashion+                    |
|    | wall and ceiling: recessed and surface mounted            |    | rotating   |    | warm dim / natural dimming LED   |
|    | ceiling-mounted and wall-mounted                          |    | illuminate tilted  |    | rechargeable battery powered   |
|    | wall-mounted  |    | color of suspension cable                                    |    | fixture with natural vivid LED (upon request)  |
|    | omni-directional light distribution                       |    | length of suspension cable                                   |    | color rendering index  |
|    | direct light distribution                                 |    | reflector degree selection                                   |    | color temperature  |
|    | direct/indirect light distribution                        |    | super spot   |    | lumen (luminous flux)  |
|    | indirect light distribution                               |    | lens   |    | efficacy (lumens per watt)   |
|    | asymmetric light distribution                             |    | lens pack  |    | Unified Glare Rating (UGR) range from 5-40   |
|    | aura light distribution                                   |    | shine ring   |    | marine grade (AISI 316 stainless steel)  |
|    | round wall or ceiling cut-out                             |    | integrated shine ring with diffuser                          |    | walk on  |
|    | square wall or ceiling cut-out                            |    | free individual colors 01-29                                 |    | drive on   |
|    | the supplied jig specifies the cutout dimensions          |    | individual colors: 00 (free of charge), 01-25 (extra charge) |    | Dark Sky Compliance  |
|    | minimum distance (meters) lamp - object                   |    | luminaire part to be colored (F1)                            |    | Americans with Disabilities Act (less than 4" off the wall located between 27"-84" from floor) |
|    | recessed depth  |    | luminaire part to be colored (F2)                            |    | lamp protected against explosion   |
|   | ceiling thickness in mm                                   |   | luminaire part to be colored (F3)                            |   | blown glass using traditional methods by master glass blower                                   |
|  | ceiling thickness selection                               |  | luminaire part to be colored (F4)                            |  | acoustic material  |
|  | dimnable DP (phase), DV (0-10V), DD (dali), DS (step-dim) |  | luminaire part to be colored (F5)                            |  | protection class I, protection insulation  |
|  | included or excluded LED driver/transformer/control gear  |  | color of 3-circuit adaptor                                   |  | protection class II, protection insulation   |
|  | separately switchable                                     |  | indirect diffuser  |  | ETL Certified to UL and CSA Standards  |
|  | sensor  |  | direct diffuser  |  | UL Certified to UL and CSA Standards   |
|  | remote control  |  | ball-proof (upon request)                                    |  | CSA Certified to UL and CSA Standards  |
|  | available upon request                                    |  | accessory  |  | Certified for North American Standards   |

### IP RATING

|   |  |
|---|--|
|  | protected against ingress of solid bodies greater than 12.5mm (finger)   |
|  | protected against ingress of solid bodies greater than 2.5mm<br>protected against sprays of water up to 60 degrees from the vertical (rain)      |
|  | protected against ingress of solid bodies greater than 1mm (wire)<br>no protection against the ingress of moisture                               |
|  | protected against ingress of solid bodies greater than 1mm (wire)<br>protected against sprays of water up to 60 degrees from the vertical (rain) |
|  | protected against ingress of solid bodies greater than 1mm (wire)<br>protected against water splashed from all directions                        |
|  | protected against limited ingress of dust (wet rooms/covered outdoor areas)<br>protected against water splashed from all directions              |
|  | protected against ingress of dust<br>protected against jets of water   |
|  | protected against ingress of dust<br>protected against powerful jets of water or heavy seas  |
|  | protected against ingress of dust<br>protected against immersion of water between 15cm - 1m for 30 minutes                                       |
|  | protected against ingress of dust<br>protected against immersion of water under pressure for long periods  |

### IK RATING

|   |   |
|---|---|
|  | protected against 0.14 joules impact (equivalent to 0.25kg mass dropped from 56mm above the surface)  |
|  | protected against 0.2 joules impact (equivalent to 0.25kg mass dropped from 80mm above the surface)   |
|  | protected against 0.35 joules impact (equivalent to 0.25kg mass dropped from 140mm above the surface) |
|  | protected against 0.5 joules impact (equivalent to 0.25kg mass dropped from 200mm above the surface)  |
|  | protected against 0.7 joules impact (equivalent to 0.25kg mass dropped from 280mm above the surface)  |
|  | protected against 1 joules impact (equivalent to 0.25kg mass dropped from 400mm above the surface)    |
|  | protected against 2 joules impact (equivalent to 0.5kg mass dropped from 400mm above the surface)     |
|  | protected against 5 joules impact (equivalent to 1.7kg mass dropped from 300mm above the surface)     |
|  | protected against 10 joules impact (equivalent to 5.0kg mass dropped from 200mm above the surface)    |
|  | protected against 20 joules impact (equivalent to 5.0kg mass dropped from 400mm above the surface)    |