

PROJECT	_____
TYPE	_____
SPECIFIER	_____
QUANTITY	_____
DATE	_____

## POMA SUSPENSION

### D111073-

base number	Finish Options	Finish Options
-------------	----------------	----------------

- To build a product code in our configurator select the specify button on the base model # product page
- To build a manual product code on this datasheet choose from the options listed below in blue font and add the suffix to the base model #

#### GENERAL

Series: Poma
Brand: Ole
Division: Design
Mounting Type: Suspension
Mounting Location: Ceiling
Subcategory: Ambient

#### PHYSICAL

Shape: Cylinder
Diameter (mm): 450
Diameter (in): 17 11/16
Height (mm): 650
Height (in): 25 9/16
Max. Overall Height (mm): 2650
Max. Overall Height (in): 104 5/16
Light Distribution: Direct
Fixture Finish: <a href="#">BEI</a> / <a href="#">BLK</a> / <a href="#">BLU</a> / <a href="#">COG</a> / <a href="#">DGN</a> / <a href="#">GRY</a> / <a href="#">MRN</a> / <a href="#">MOC</a> / <a href="#">MUS</a> / <a href="#">OLV</a> / <a href="#">SIL</a> / <a href="#">STN</a> / <a href="#">TER</a> / <a href="#">WHI</a>
Holder Finish: <a href="#">MWH</a> / <a href="#">MBK</a>
Fixture Material: Fabric Cord / Metal
Cable Details: 2000mm Cable
Upon Request: Other fabric cord colors available upon request (see downloadable finish chart)

#### ELECTRICAL

Number of Lamps: 1
Lamp Type: LED Retrofit
Lamp Shape: A19
Bulb Included: Bulb Not Included
Max. Wattage Per Lamp (W): 15
Lamp Base: E26
Input Voltage (V): 120
Upon Request: 277Vac / GU24

#### LED

#### OPTICAL

#### RATINGS AND CERTIFICATIONS

Certified By: Certified for North American Standards
IP rating: IP20



## POMA SUSPENSION

D111073-

PROJECT

TYPE

SPECIFIER

QUANTITY

DATE

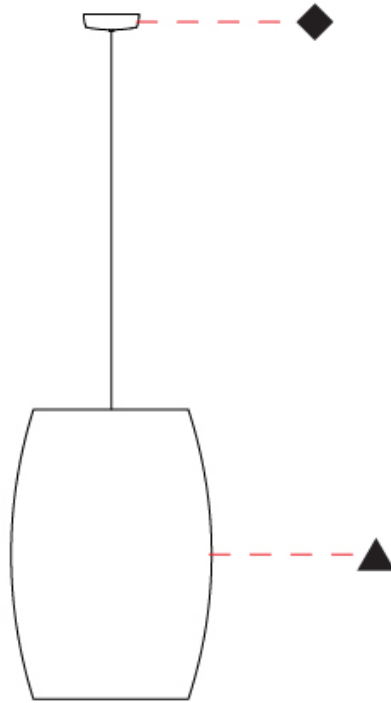

D

## POMA SUSPENSION

### D111074-

base number      Finish Options      Finish Options

- To build a product code in our configurator select the specify button on the base model # product page
- To build a manual product code on this datasheet choose from the options listed below in blue font and add the suffix to the base model #

#### GENERAL

Series: Poma  
 Brand: Ole  
 Division: Design  
 Mounting Type: Suspension  
 Mounting Location: Ceiling  
 Subcategory: Ambient

#### PHYSICAL

Shape: Cylinder  
 Diameter (mm): 600  
 Diameter (in): 23 <sup>5</sup>/<sub>8</sub>  
 Height (mm): 500  
 Height (in): 19 <sup>11</sup>/<sub>16</sub>  
 Max. Overall Height (mm): 2500  
 Max. Overall Height (in): 98 <sup>7</sup>/<sub>16</sub>  
 Light Distribution: Direct  
 Fixture Finish: [BEI](#) / [BLK](#) / [BLU](#) / [COG](#) / [DGN](#) / [GRY](#) / [MRN](#) / [MOC](#) / [MUS](#) / [OLV](#) / [SIL](#) / [STN](#) / [TER](#) / [WHI](#)  
 Holder Finish: [MWH](#) / [MBK](#)  
 Fixture Material: Fabric Cord / Metal  
 Cable Details: 2000mm Cable  
 Upon Request: Other fabric cord colors available upon request (see downloadable finish chart)

#### ELECTRICAL

Number of Lamps: 1  
 Lamp Type: LED Retrofit  
 Lamp Shape: A19  
 Bulb Included: Bulb Not Included  
 Max. Wattage Per Lamp (W): 15  
 Lamp Base: E26  
 Input Voltage (V): 120  
 Upon Request: 277Vac / GU24

#### LED

#### OPTICAL

#### RATINGS AND CERTIFICATIONS

Certified By: Certified for North American Standards  
 IP rating: IP20

PROJECT
TYPE
SPECIFIER
QUANTITY
DATE

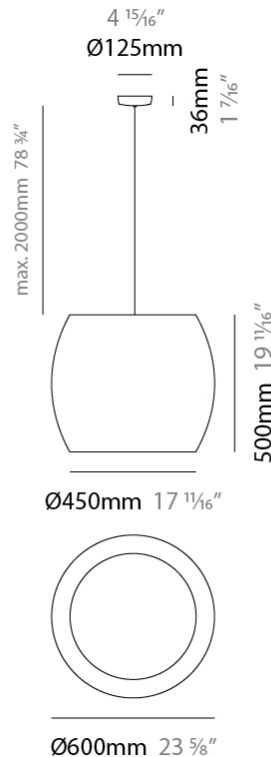

## POMA SUSPENSION

D111074-

PROJECT

TYPE

SPECIFIER

QUANTITY

DATE

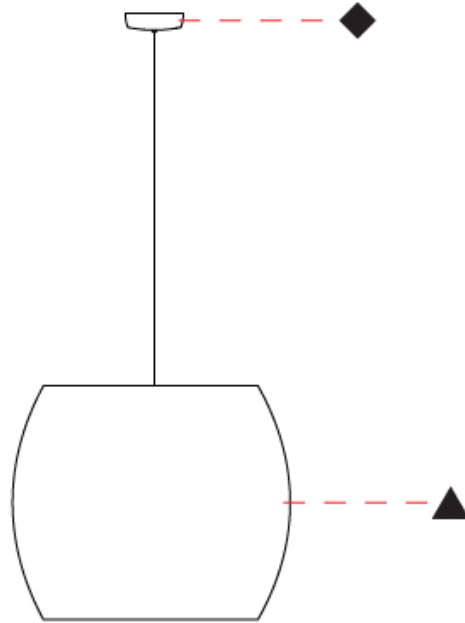

D

## POMA SUSPENSION

### D111075- \_\_\_\_\_

base number      Finish Options      Finish Options

- To build a product code in our configurator select the specify button on the base model # product page
- To build a manual product code on this datasheet choose from the options listed below in blue font and add the suffix to the base model #

#### GENERAL

Series: Poma  
 Brand: Ole  
 Division: Design  
 Mounting Type: Suspension  
 Mounting Location: Ceiling  
 Subcategory: Ambient

#### PHYSICAL

Shape: Cylinder  
 Diameter (mm): 750  
 Diameter (in): 29 1/2  
 Height (mm): 400  
 Height (in): 15 3/4  
 Max. Overall Height (mm): 2400  
 Max. Overall Height (in): 4 1/2  
 Light Distribution: Direct  
 Fixture Finish: BEI / BLK / BLU / COG / DGN / GRY / MRN / MOC / MUS / OLV / SIL / STN / TER / WHI  
 Holder Finish: MWH / MBK  
 Fixture Material: Fabric Cord / Metal  
 Cable Details: 2000mm Cable  
 Upon Request: Other fabric cord colors available upon request (see downloadable finish chart)

#### ELECTRICAL

Number of Lamps: 1  
 Lamp Type: LED Retrofit  
 Lamp Shape: A19  
 Bulb Included: Bulb Not Included  
 Max. Wattage Per Lamp (W): 15  
 Lamp Base: E26  
 Input Voltage (V): 120  
 Upon Request: 277Vac / GU24

#### LED

#### OPTICAL

#### RATINGS AND CERTIFICATIONS

Certified By: Certified for North American Standards  
 IP rating: IP20

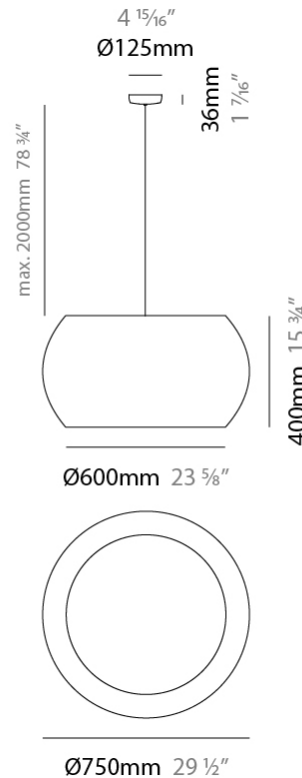

## POMA SUSPENSION

D111075-

PROJECT

TYPE

SPECIFIER

QUANTITY

DATE

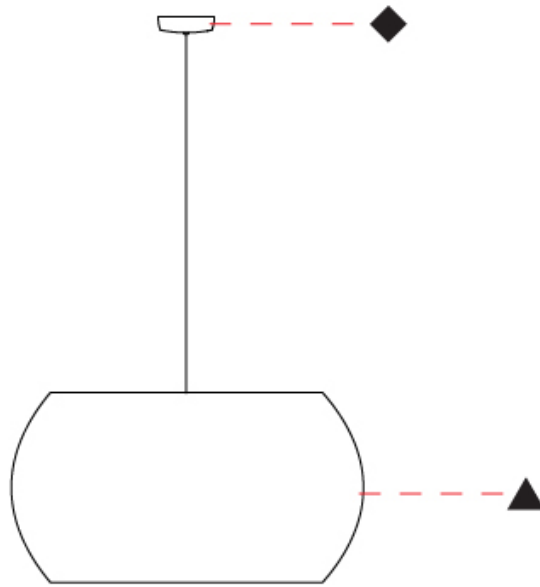

D

## POMA

### COLOR FINISH CHART

#### Fixture Finish

Beige - BEI



Black - BLK



Blue - BLU



Cognac - COG



Dark Green - DGN



Gray - GRY

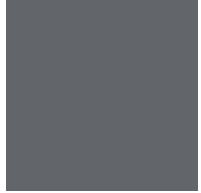

Maroon - MRN



Mocha - MOC



Mustard - MUS



Olive - OLV



Silver - SIL

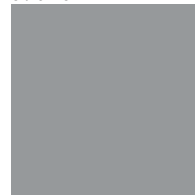

Stone - STN



Terracotta - TER



White - WHI

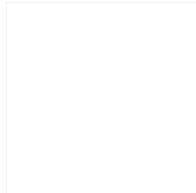

#### Holder Finish

Matte White - MWH



Matte Black - MBK



**Digital:** Not all screens are calibrated the same, and therefore, colors will appear differently between screens.

**Physical:** When texture is involved, there will be variations in color, character and tone within a product series and between product families.



## COLOR FINISH CHART

BEIGE - BEI  
 Pant. 727C 196



BLACK - BLK  
 Pant. BLACK C 211



BLUE - BLU  
 Pant. 653C 61



COGNAC - COG  
 Pant. BLACK C 255



DARK GREEN - DGN  
 Pant. 5616C 301



GRAY - GRY  
 Pant. 10C 120



MAROON - MRN  
 Pant. 1955C 224



MOCHA - MOC  
 Pant. 7504C 175



MUSTARD - MUS  
 Pant. 1245C 168



OLIVE - OLV  
 Pant. 5625C 323



SILVER - SIL  
 Pant. 7C 129



STONE - STN  
 Pant. 7528C 1196



TERRACOTTA - TER  
 Pant. 153C 205



WHITE - WHI  
 Pant. WHITE 71



**Digital:** Not all screens are calibrated the same, and therefore, colors will appear differently between screens.

**Physical:** When texture is involved, there will be variations in color, character and tone within a product series and between product families.



## COMPLETE COLOR FINISH CHART



Standard Colors with [S-]

Other fabric cord colors available upon request. Price increase and minimum quantities may apply

**Digital:** Not all screens are calibrated the same, and therefore, colors will appear differently between screens.

**Physical:** When texture is involved, there will be variations in color, character and tone within a product series and between product families.

Zaneen Group Inc. © 2024, T 1800-388-3382, F 416-247-9319, www.zaneen.com

Available for International specifications by adding 'INT' at the end of the existing Model #. For assistance on 'custom' specifications, contact zteam@zaneen.com.

In a constant effort to supply the best product, we reserve the right to change specifications or materials without notice. The most recent specification sheets are found at zaneen.com

## COMPLETE COLOR FINISH CHART

JADE  
 Pant. 3268C 311



VERDE BILLAR  
 Pant. 340C 353



JUNGLA  
 Pant. 356C 310



VERDE OSC.  
 Pant. 3298C 358



MUSGO  
 Pant. 5535C 320



S - DARK GREEN  
 Pant. 5616C 301



S - OLIVE  
 Pant. 5625C 323



CIRUELA  
 Pant. 368C 104



LAVANDA  
 Pant. 374C 2214



CRUDO  
 Pant. 7401C 170



OPALE  
 Pant. 402 1442



S - STONE - STN  
 Pant. 7528C 1196



ASTRACAN  
 Pant. 7529C 101



CAMELLO  
 Pant. 731C 161



CASTANO  
 Pant. 4625C 1674



TABACO  
 Pant. 1545C 203



MARRON  
 Pant. 476C 187



MARRON SUPER  
 Pant. BLACK 4C 189



MADERA  
 Pant. 7519C 2183



S - MOCHA  
 Pant. 7504C 175



AVELLANA  
 Pant. 729C 152



S - BEIGE - BEI  
 Pant. 727C 196



ARENA  
 Pant. 465C 151



BEIGE / CAMEL  
 Pant. 1265C 154



Standard Colors with [S-]

Other fabric cord colors available upon request. Price increase and minimum quantities may apply

**Digital:** Not all screens are calibrated the same, and therefore, colors will appear differently between screens.

**Physical:** When texture is involved, there will be variations in color, character and tone within a product series and between product families.

Zaneen Group Inc. © 2024, T 1800-388-3382, F 416-247-9319, www.zaneen.com

Available for International specifications by adding 'INT' at the end of the existing Model #. For assistance on 'custom' specifications, contact zteam@zaneen.com.

In a constant effort to supply the best product, we reserve the right to change specifications or materials without notice. The most recent specification sheets are found at zaneen.com

## COMPLETE COLOR FINISH CHART

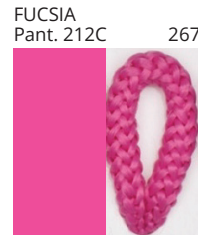
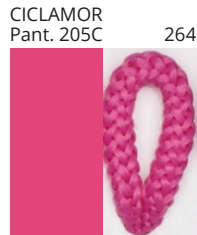
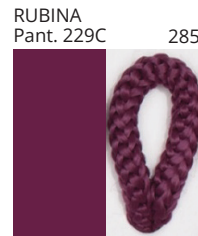
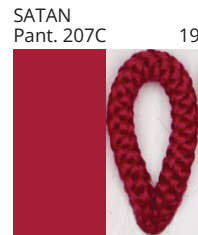

Standard Colors with [S-]

Other fabric cord colors available upon request. Price increase and minimum quantities may apply

**Digital:** Not all screens are calibrated the same, and therefore, colors will appear differently between screens.

**Physical:** When texture is involved, there will be variations in color, character and tone within a product series and between product families.

Zaneen Group Inc. © 2024, T 1800-388-3382, F 416-247-9319, www.zaneen.com

Available for International specifications by adding 'INT' at the end of the existing Model #. For assistance on 'custom' specifications, contact zteam@zaneen.com.

In a constant effort to supply the best product, we reserve the right to change specifications or materials without notice. The most recent specification sheets are found at zaneen.com

PROJECT \_\_\_\_\_  
TYPE \_\_\_\_\_  
NOTES \_\_\_\_\_  
QUANTITY \_\_\_\_\_  
DATE \_\_\_\_\_

## COMPLETE COLOR FINISH CHART

ROSA PASTEL  
Pant. 1905C 281



ALEJANDRIA  
Pant. 196C 261



CANET  
Pant. 2717C 43



MALVA  
Pant. 2567C 141



AMORATADO  
Pant. 265C 135



LAPIZLAZULI  
Pant. 2745C 62



VIOLETA  
Pant. 7676C 147



Standard Colors with [S-]

Other fabric cord colors available upon request. Price increase and minimum quantities may apply

**Digital:** Not all screens are calibrated the same, and therefore, colors will appear differently between screens.

**Physical:** When texture is involved, there will be variations in color, character and tone within a product series and between product families.

Zaneen Group Inc. © 2024, T 1800-388-3382, F 416-247-9319, [www.zaneen.com](http://www.zaneen.com)

Available for International specifications by adding 'INT' at the end of the existing Model #. For assistance on 'custom' specifications, contact [zteam@zaneen.com](mailto:zteam@zaneen.com).

In a constant effort to supply the best product, we reserve the right to change specifications or materials without notice. The most recent specification sheets are found at [zaneen.com](http://zaneen.com)

PROJECT	
TYPE	
SPECIFIER	
QUANTITY	
DATE	

### LEGEND

floor-mounted	pivotal	special LED (upon request) RGB, RGBW, tunable, gold+, meat+, art+, fashion+
wall and ceiling: recessed and surface mounted	rotating	warm dim / natural dimming LED
ceiling-mounted and wall-mounted	illuminate tilted	rechargeable battery powered
wall-mounted	color of suspension cable	fixture with natural vivid LED (upon request)
omni-directional light distribution	length of suspension cable	color rendering index
direct light distribution	reflector degree selection	color temperature
direct/indirect light distribution	super spot	lumen (luminous flux)
indirect light distribution	lens	efficacy (lumens per watt)
asymmetric light distribution	lens pack	Unified Glare Rating (UGR) range from 5-40
aura light distribution	shine ring	marine grade (AISI 316 stainless steel)
round wall or ceiling cut-out	integrated shine ring with diffuser	walk on
square wall or ceiling cut-out	free individual colors 01-29	drive on
the supplied jig specifies the cutout dimensions	individual colors: 00 (free of charge), 01-25 (extra charge)	Dark Sky Compliance
minimum distance (meters) lamp - object	luminaire part to be colored (F1)	Americans with Disabilities Act (less than 4" off the wall located between 27"-84" from floor)
recessed depth	luminaire part to be colored (F2)	lamp protected against explosion
ceiling thickness in mm	luminaire part to be colored (F3)	blown glass using traditional methods by master glass blower
ceiling thickness selection	luminaire part to be colored (F4)	acoustic material
dimmable DP (phase), DV (0-10V), DD (dali), DS (step-dim)	luminaire part to be colored (F5)	protection class I, protection insulation
included or excluded LED driver/transformer/control gear	color of 3-circuit adaptor	protection class II, protection insulation
separately switchable	indirect diffuser	ETL Certified to UL and CSA Standards
sensor	direct diffuser	UL Certified to UL and CSA Standards
remote control	ball-proof (upon request)	CSA Certified to UL and CSA Standards
available upon request	accessory	Certified for North American Standards

### IP RATING

IP20	protected against ingress of solid bodies greater than 12.5mm (finger)
IP33	protected against ingress of solid bodies greater than 2.5mm protected against sprays of water up to 60 degrees from the vertical (rain)
IP40	protected against ingress of solid bodies greater than 1mm (wire) no protection against the ingress of moisture
IP43	protected against ingress of solid bodies greater than 1mm (wire) protected against sprays of water up to 60 degrees from the vertical (rain)
IP44	protected against ingress of solid bodies greater than 1mm (wire) protected against water splashed from all directions
IP54	protected against limited ingress of dust (wet rooms/covered outdoor areas) protected against water splashed from all directions
IP65	protected against ingress of dust protected against jets of water
IP66	protected against ingress of dust protected against powerful jets of water or heavy seas
IP67	protected against ingress of dust protected against immersion of water between 15cm - 1m for 30 minutes
IP68	protected against ingress of dust protected against immersion of water under pressure for long periods

### IK RATING

IK01	protected against 0.14 joules impact (equivalent to 0.25kg mass dropped from 56mm above the surface)
IK02	protected against 0.2 joules impact (equivalent to 0.25kg mass dropped from 80mm above the surface)
IK03	protected against 0.35 joules impact (equivalent to 0.25kg mass dropped from 140mm above the surface)
IK04	protected against 0.5 joules impact (equivalent to 0.25kg mass dropped from 200mm above the surface)
IK05	protected against 0.7 joules impact (equivalent to 0.25kg mass dropped from 280mm above the surface)
IK06	protected against 1 joules impact (equivalent to 0.25kg mass dropped from 400mm above the surface)
IK07	protected against 2 joules impact (equivalent to 0.5kg mass dropped from 400mm above the surface)
IK08	protected against 5 joules impact (equivalent to 1.7kg mass dropped from 300mm above the surface)
IK09	protected against 10 joules impact (equivalent to 5.0kg mass dropped from 200mm above the surface)
IK10	protected against 20 joules impact (equivalent to 5.0kg mass dropped from 400mm above the surface)