

PROJECT	
TYPE	
SPECIFIER	
QUANTITY	
DATE	

POP 11 LIGHT SUSPENSION

D41036-

base number Finish
Options

- To build a product code in our configurator select the specify button on the base model # product page
- To build a manual product code on this datasheet choose from the options listed below in blue font and add the suffix to the base model #

GENERAL

Series: Pop
 Subseries: Pop 11 Light
 Partner: Icone
 Division: Design
 Installation: Suspension
 Product Type: Pendant
 Mounting Location: Ceiling
 Light Distribution: Direct

PHYSICAL

Shape: Rectangle
 Length (mm): 900
 Length (in): 35 ⁷/₁₆
 Width (mm): 450
 Width (in): 17 ¹¹/₁₆
 Fixture Finish: WHI / WAM / BKA / GBG / SLA
 Fixture Material: Aluminum

ELECTRICAL

Lamp Type: LED
 Total Output Wattage (W): 50
 Dimming: Electronic Low Voltage Dimming
 Input Voltage (V): 120Vac Direct Line

LED

Number of LEDs: 11
 Color Temperature (°K): 3000
 Nominal Lumen (lm): 3850
 CRI: >90 CRI
 Lamp Life (hrs): 50000

OPTICAL

RATINGS AND CERTIFICATIONS

Certified By: Certified for North American Standards
 IP rating: IP20

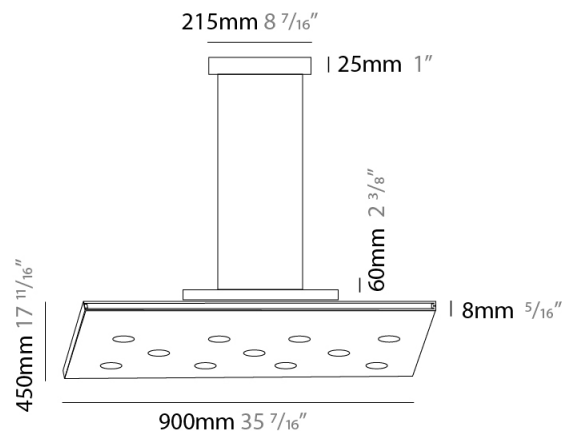
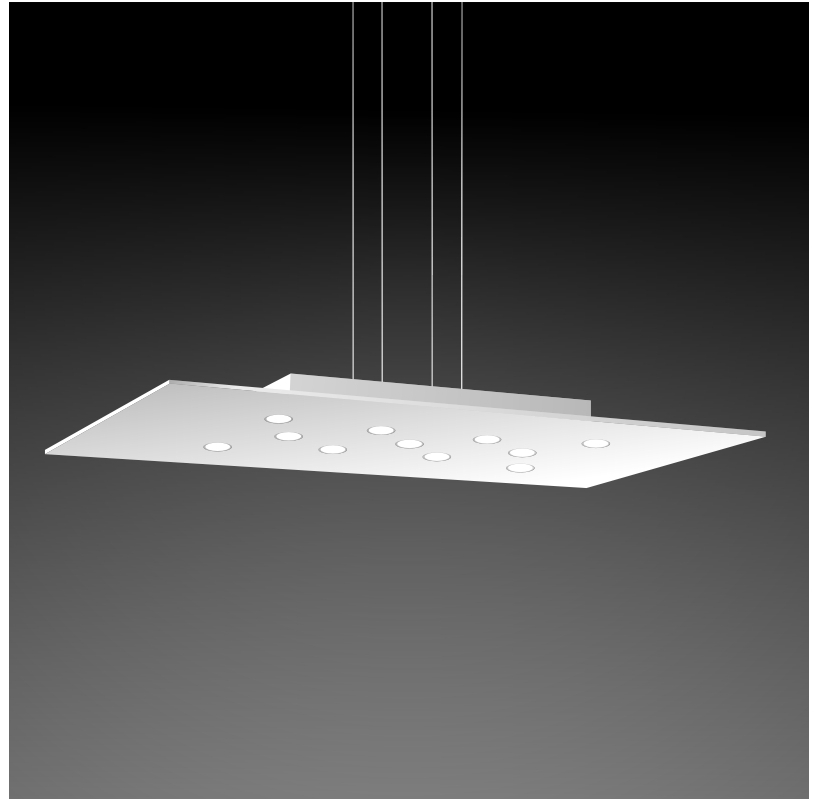

POP 11 LIGHT SUSPENSION

D41036-

PROJECT

TYPE

SPECIFIER

QUANTITY

DATE

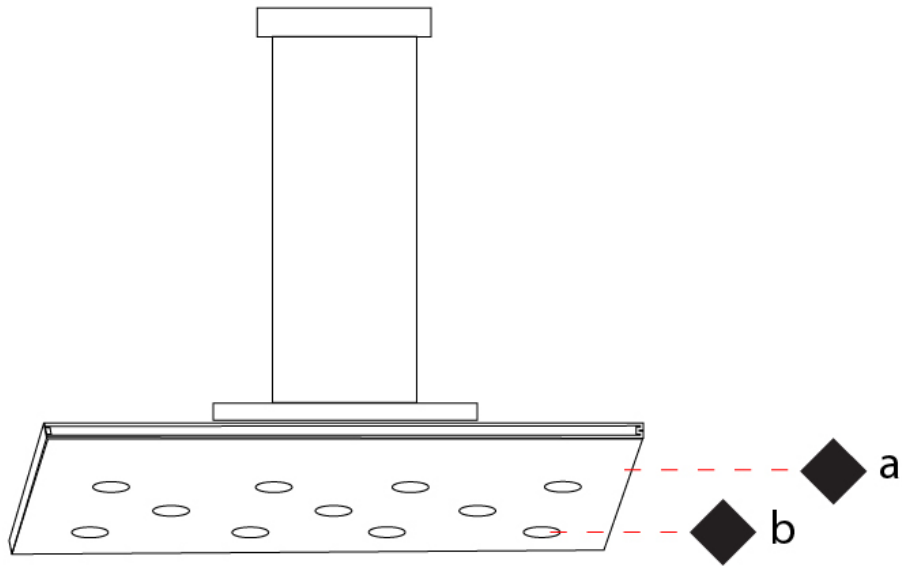

D

PROJECT	_____
TYPE	_____
SPECIFIER	_____
QUANTITY	_____
DATE	_____

POP 11 LIGHT SUSPENSION

D41037-

base number Finish
Options

- To build a product code in our configurator select the specify button on the base model # product page
- To build a manual product code on this datasheet choose from the options listed below in blue font and add the suffix to the base model #

GENERAL

Series: Pop
Subseries: Pop 11 Light
Partner: Icone
Division: Design
Installation: Suspension
Product Type: Pendant
Mounting Location: Ceiling
Light Distribution: Direct

PHYSICAL

Shape: Rectangle
Length (mm): 900
Length (in): 35 ⁷/₁₆
Width (mm): 450
Width (in): 17 ¹¹/₁₆
Fixture Finish: WHI / WAM / BKA / GBG / SLA
Fixture Material: Aluminum

ELECTRICAL

Lamp Type: LED
Total Output Wattage (W): 67
Dimming: Electronic Low Voltage Dimming
Input Voltage (V): 120Vac Direct Line

LED

Number of LEDs: Dir 11 + Ind 1
Color Temperature (°K): 3000
Nominal Lumen (lm): Dir 3850 + Ind 1350
CRI: >90 CRI
Lamp Life (hrs): 50000

OPTICAL

RATINGS AND CERTIFICATIONS

Certified By: Certified for North American Standards
IP rating: IP20

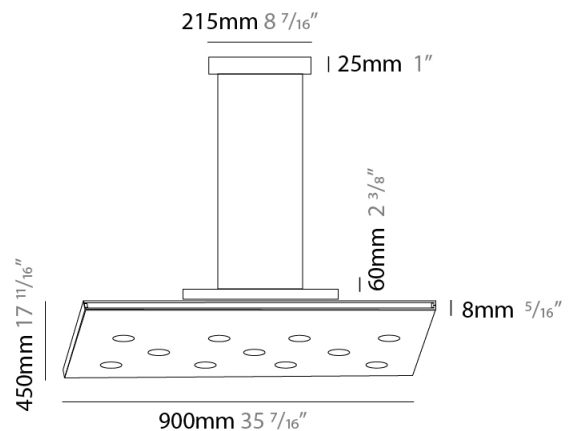
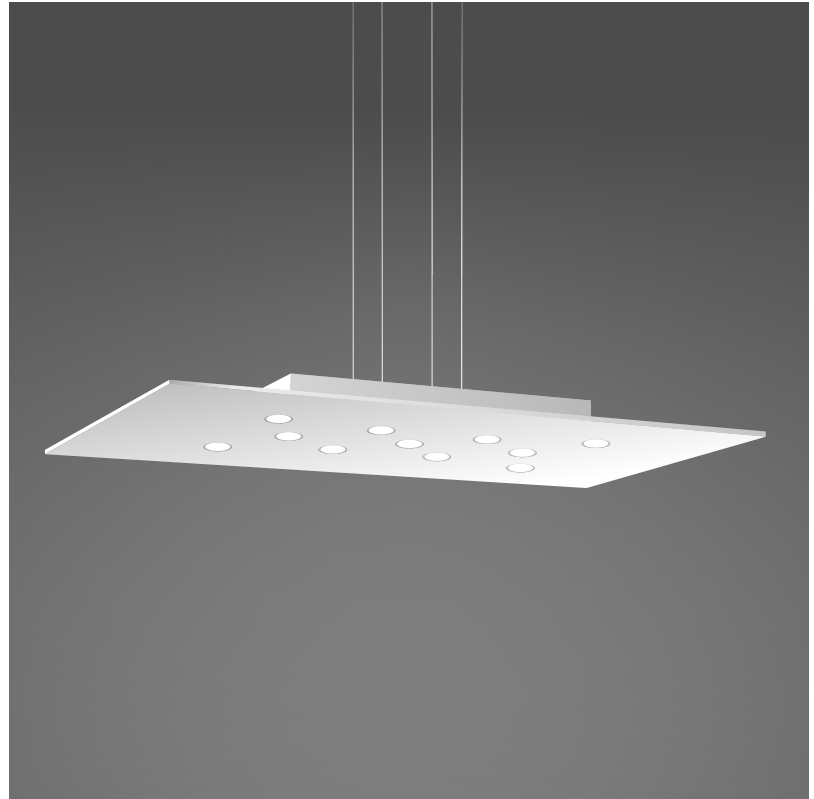

POP 11 LIGHT SUSPENSION

D41037-

PROJECT _____

TYPE _____

SPECIFIER _____

QUANTITY _____

DATE _____

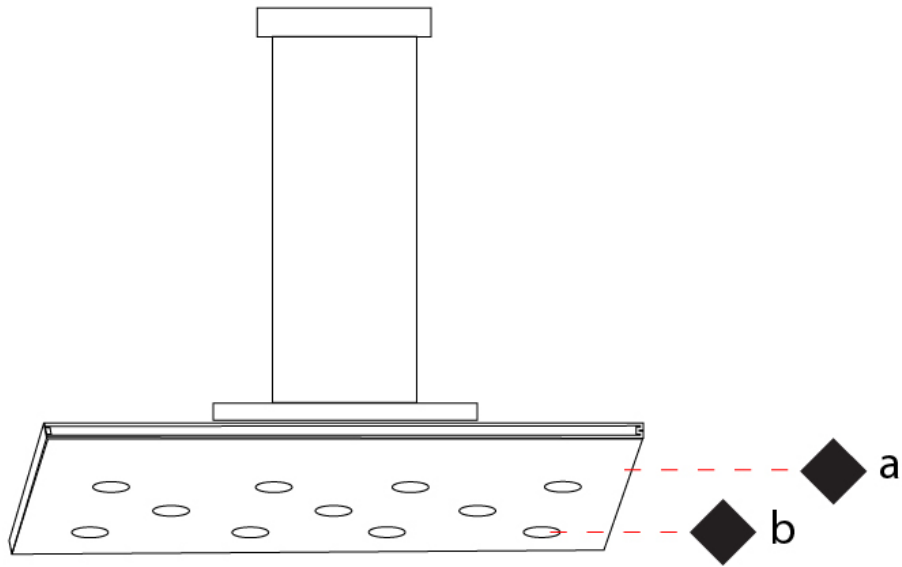

D

PROJECT	_____
TYPE	_____
SPECIFIER	_____
QUANTITY	_____
DATE	_____

POP 5 LIGHT SURFACE

D42025-

base number Finish
Options

- To build a product code in our configurator select the specify button on the base model # product page
- To build a manual product code on this datasheet choose from the options listed below in blue font and add the suffix to the base model #

GENERAL

Series: Pop
Subseries: Pop 5 Light
Partner: Icone
Division: Design
Installation: Surface
Product Type: Ceiling Surface
Mounting Location: Ceiling
Light Distribution: Direct

PHYSICAL

Shape: Rectangle
Length (mm): 250
Length (in): 9 ¹³/₁₆"
Width (mm): 450
Width (in): 17 ¹¹/₁₆"
Extension (mm): 30
Extension (in): 1 ³/₁₆"
[Fixture Finish: WHI / WAM / BKA / GBG / SLA](#)
Fixture Material: Aluminum

ELECTRICAL

Lamp Type: LED
Total Output Wattage (W): 22.5
Dimming: Electronic Low Voltage Dimming
Input Voltage (V): 120Vac Direct Line

LED

Number of LEDs: 5
Color Temperature (°K): 3000
Nominal Lumen (lm): 1750
CRI: >90 CRI
Lamp Life (hrs): 50000

OPTICAL

RATINGS AND CERTIFICATIONS

Certified By: Certified for North American Standards
IP rating: IP20

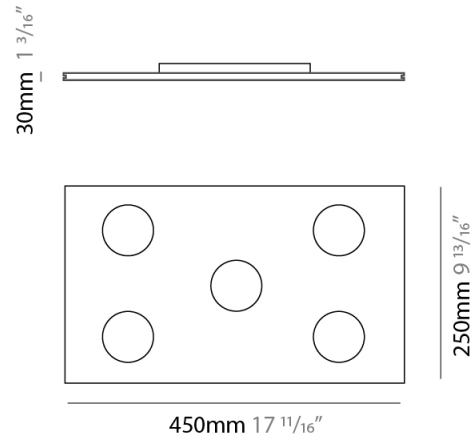

POP 5 LIGHT SURFACE

D42025-

PROJECT _____

TYPE _____

SPECIFIER _____

QUANTITY _____

DATE _____

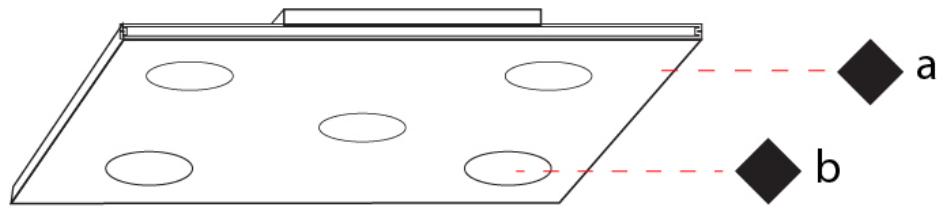

D

PROJECT	
TYPE	
SPECIFIER	
QUANTITY	
DATE	

POP 5 LIGHT SURFACE

D42025- : D42025-WAM

base number

- To build a product code in our configurator select the specify button on the base model # product page
- To build a manual product code on this datasheet choose from the options listed below in blue font and add the suffix to the base model #

GENERAL

Series: Pop
 Subseries: Pop 5 Light
 Partner: Icone
 Division: Design
 Installation: Surface
 Product Type: Ceiling Surface
 Mounting Location: Ceiling
 Light Distribution: Direct

PHYSICAL

Shape: Rectangle
 Length (mm): 250
 Length (in): 9 ¹³/₁₆
 Width (mm): 450
 Width (in): 17 ¹¹/₁₆
 Height (mm): 30
 Height (in): 1 ³/₁₆
 Extension (mm): 30
 Extension (in): 1 ³/₁₆
 Weight (kg): 1.4
 Weight (lbs): 2.999
 Fixture Material: Aluminum

ELECTRICAL

Lamp Type: LED
 Total Output Wattage (W): 22.5
 Max. Wattage Per Lamp (W): 4.5
 Dimming: Electronic Low Voltage Dimming
 Input Voltage (V): 120

LED

Number of LEDs: 5
 Color Temperature (°K): 3000
 Nominal Lumen (lm): 1750
 CRI: >90 CRI
 Lamp Life (hrs): 50000

OPTICAL

RATINGS AND CERTIFICATIONS

Certified By: CSA Certified to UL and CSA Standards
 IP rating: IP20

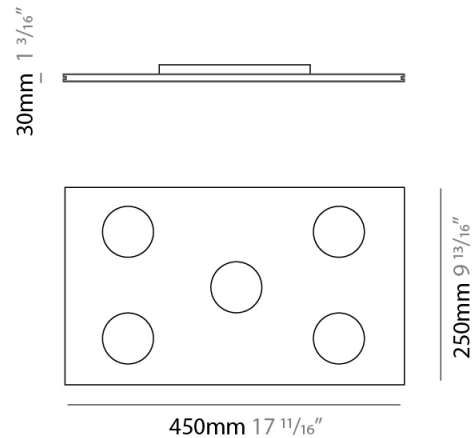

POP 5 LIGHT SURFACE

D42025- : D42025-WAM

PROJECT

TYPE

SPECIFIER

QUANTITY

DATE

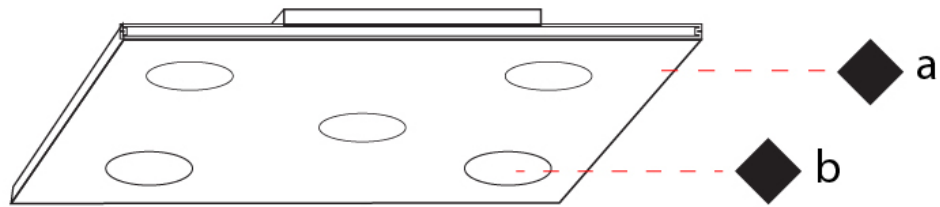

D

PROJECT
TYPE
SPECIFIER
QUANTITY
DATE

POP 8 LIGHT SURFACE

D42026-

base number Finish
Options

- To build a product code in our configurator select the specify button on the base model # product page
- To build a manual product code on this datasheet choose from the options listed below in blue font and add the suffix to the base model #

GENERAL

Series: Pop
 Subseries: Pop 8 Light
 Partner: Icone
 Division: Design
 Installation: Surface
 Product Type: Ceiling Surface
 Mounting Location: Ceiling
 Light Distribution: Direct

PHYSICAL

Shape: Rectangle
 Length (mm): 300
 Length (in): 11 ¹³/₁₆
 Width (mm): 600
 Width (in): 23 ⁵/₈
 Extension (mm): 30
 Extension (in): 1 ³/₁₆
 Fixture Finish: WHI / WAM / BKA / GBG / SLA
 Fixture Material: Aluminum

ELECTRICAL

Lamp Type: LED
 Total Output Wattage (W): 36
 Dimming: Electronic Low Voltage Dimming
 Input Voltage (V): 120Vac Direct Line

LED

Number of LEDs: 8
 Color Temperature (°K): 3000
 Nominal Lumen (lm): 2800
 CRI: >90 CRI
 Lamp Life (hrs): 50000

OPTICAL

RATINGS AND CERTIFICATIONS

Certified By: Certified for North American Standards
 IP rating: IP20

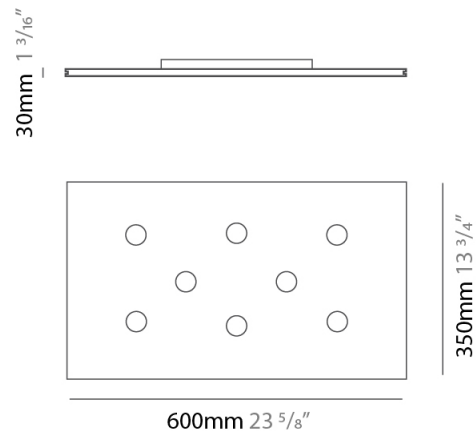

POP 8 LIGHT SURFACE

D42026-

PROJECT _____

TYPE _____

SPECIFIER _____

QUANTITY _____

DATE _____

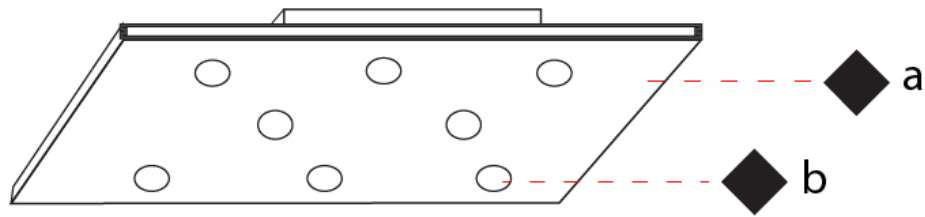

D

PROJECT
TYPE
SPECIFIER
QUANTITY
DATE

POP 11 LIGHT SURFACE

D42027-

base number Finish
Options

- To build a product code in our configurator select the specify button on the base model # product page
- To build a manual product code on this datasheet choose from the options listed below in blue font and add the suffix to the base model #

GENERAL

Series: Pop
Subseries: Pop 11 Light
Partner: Icone
Division: Design
Installation: Surface
Product Type: Ceiling Surface
Mounting Location: Ceiling
Light Distribution: Direct

PHYSICAL

Shape: Rectangle
Length (mm): 450
Length (in): 17 ¹¹/₁₆
Width (mm): 900
Width (in): 35 ⁷/₁₆
Extension (mm): 30
Extension (in): 1 ³/₁₆
[Fixture Finish: WHI / WAM / BKA / GBG / SLA](#)
Fixture Material: Aluminum

ELECTRICAL

Lamp Type: LED
Total Output Wattage (W): 49.5
Dimming: Electronic Low Voltage Dimming
Input Voltage (V): 120Vac Direct Line

LED

Number of LEDs: 11
Color Temperature (°K): 3000
Nominal Lumen (lm): 3850
CRI: >90 CRI
Lamp Life (hrs): 50000

OPTICAL

RATINGS AND CERTIFICATIONS

Certified By: Certified for North American Standards
IP rating: IP20

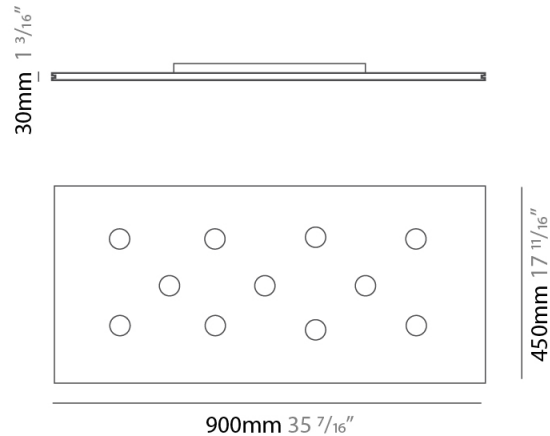

POP 11 LIGHT SURFACE

D42027-

PROJECT	_____
TYPE	_____
SPECIFIER	_____
QUANTITY	_____
DATE	_____

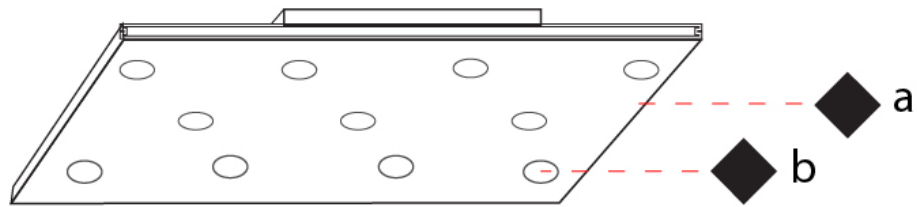

PROJECT	
TYPE	
SPECIFIER	
QUANTITY	
DATE	

POP 11 LIGHT SURFACE

D42027- : D42027-SLA

base number

- To build a product code in our configurator select the specify button on the base model # product page
- To build a manual product code on this datasheet choose from the options listed below in blue font and add the suffix to the base model #

GENERAL

Series: Pop
 Subseries: Pop 11 Light
 Partner: Icone
 Division: Design
 Installation: Surface
 Product Type: Ceiling Surface
 Mounting Location: Ceiling
 Light Distribution: Direct

PHYSICAL

Shape: Rectangle
 Length (mm): 450
 Length (in): 17 11/16
 Width (mm): 900
 Width (in): 35 7/16
 Height (mm): 30
 Height (in): 1 3/16
 Extension (mm): 30
 Extension (in): 1 3/16
 Weight (kg): 1.4
 Weight (lbs): 2.999
 Fixture Material: Aluminum

ELECTRICAL

Lamp Type: LED
 Total Output Wattage (W): 50
 Max. Wattage Per Lamp (W): 4.5
 Dimming: Electronic Low Voltage Dimming
 Input Voltage (V): 120

LED

Number of LEDs: 11
 Color Temperature (°K): 3000
 Nominal Lumen (lm): 3850
 CRI: >90 CRI
 Lamp Life (hrs): 50000

OPTICAL

RATINGS AND CERTIFICATIONS

Certified By: CSA Certified to UL and CSA Standards
 IP rating: IP20

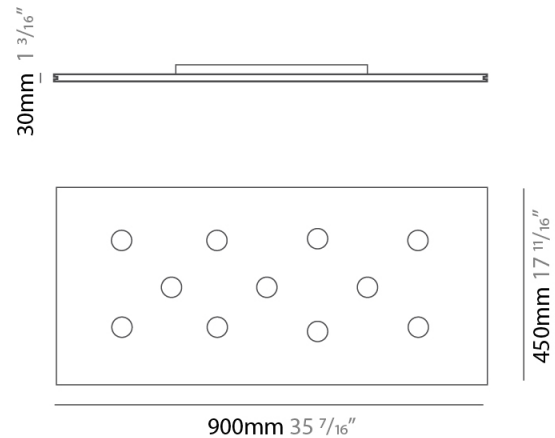

POP 11 LIGHT SURFACE

D42027- : D42027-SLA

PROJECT	_____
TYPE	_____
SPECIFIER	_____
QUANTITY	_____
DATE	_____

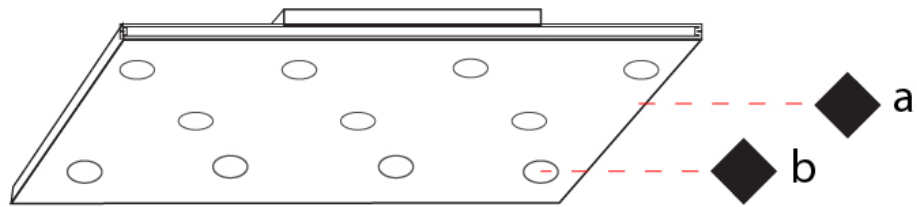

POP

COLOR FINISH CHART

PROJECT _____

TYPE _____

SPECIFIER _____

QUANTITY _____

DATE _____

Fixture Finish

White - WHI

White/Aluminium - WAM

Black/Aluminium - BKA

Gold Leaf/Brushed Gold - GBG

Silver Leaf/Aluminium - SLA







































































Digital: Not all screens are calibrated the same, and therefore, colors will appear differently between screens.











Physical: When texture is involved, there will be variations in color, character and tone within a product series and between product families.













LEGEND

	floor-mounted		pivotal		special LED (upon request) RGB, RGBW, tunable, gold+, meat+, art+, fashion+
	wall and ceiling: recessed and surface mounted		rotating		warm dim / natural dimming LED
	ceiling-mounted and wall-mounted		illuminate tilted		rechargeable battery powered
	wall-mounted		color of suspension cable		fixture with natural vivid LED (upon request)
	omni-directional light distribution		length of suspension cable		color rendering index
	direct light distribution		reflector degree selection		color temperature
	direct/indirect light distribution		super spot		lumen (luminous flux)
	indirect light distribution		lens		efficacy (lumens per watt)
	asymmetric light distribution		lens pack		Unified Glare Rating (UGR) range from 5-40
	aura light distribution		shine ring		marine grade (AISI 316 stainless steel)
	round wall or ceiling cut-out		integrated shine ring with diffuser		walk on
	square wall or ceiling cut-out		free individual colors 01-29		drive on
	the supplied jig specifies the cutout dimensions		individual colors: 00 (free of charge), 01-25 (extra charge)		Dark Sky Compliance
	minimum distance (meters) lamp - object		luminaire part to be colored (F1)		Americans with Disabilities Act (less than 4" off the wall located between 27"-84" from floor)
	recessed depth		luminaire part to be colored (F2)		lamp protected against explosion
	ceiling thickness in mm		luminaire part to be colored (F3)		blown glass using traditional methods by master glass blower
	ceiling thickness selection		luminaire part to be colored (F4)		acoustic material
	dimmable DP (phase), DV (0-10V), DD (dali), DS (step-dim)		luminaire part to be colored (F5)		protection class I, protection insulation
	included or excluded LED driver/transformer/control gear		color of 3-circuit adaptor		protection class II, protection insulation
	separately switchable		indirect diffuser		ETL Certified to UL and CSA Standards
	sensor		direct diffuser		UL Certified to UL and CSA Standards
	remote control		ball-proof (upon request)		CSA Certified to UL and CSA Standards
	available upon request		accessory		Certified for North American Standards

IP RATING

	protected against ingress of solid bodies greater than 12.5mm (finger)
	protected against ingress of solid bodies greater than 2.5mm protected against sprays of water up to 60 degrees from the vertical (rain)
	protected against ingress of solid bodies greater than 1mm (wire) no protection against the ingress of moisture
	protected against ingress of solid bodies greater than 1mm (wire) protected against sprays of water up to 60 degrees from the vertical (rain)
	protected against ingress of solid bodies greater than 1mm (wire) protected against water splashed from all directions
	protected against limited ingress of dust (wet rooms/covered outdoor areas) protected against water splashed from all directions
	protected against ingress of dust protected against jets of water
	protected against ingress of dust protected against powerful jets of water or heavy seas
	protected against ingress of dust protected against immersion of water between 15cm - 1m for 30 minutes
	protected against ingress of dust protected against immersion of water under pressure for long periods

IK RATING

	protected against 0.14 joules impact (equivalent to 0.25kg mass dropped from 56mm above the surface)
	protected against 0.2 joules impact (equivalent to 0.25kg mass dropped from 80mm above the surface)
	protected against 0.35 joules impact (equivalent to 0.25kg mass dropped from 140mm above the surface)
	protected against 0.5 joules impact (equivalent to 0.25kg mass dropped from 200mm above the surface)
	protected against 0.7 joules impact (equivalent to 0.25kg mass dropped from 280mm above the surface)
	protected against 1 joules impact (equivalent to 0.25kg mass dropped from 400mm above the surface)
	protected against 2 joules impact (equivalent to 0.5kg mass dropped from 400mm above the surface)
	protected against 5 joules impact (equivalent to 1.7kg mass dropped from 300mm above the surface)
	protected against 10 joules impact (equivalent to 5.0kg mass dropped from 200mm above the surface)
	protected against 20 joules impact (equivalent to 5.0kg mass dropped from 400mm above the surface)