

PROJECT	_____
TYPE	_____
SPECIFIER	_____
QUANTITY	_____
DATE	_____

ROL PORTABLE

D94069-

base number Finish
Options

- To build a product code in our configurator select the specify button on the base model # product page
- To build a manual product code on this datasheet choose from the options listed below in blue font and add the suffix to the base model #

GENERAL

Series: Rol _____
 Brand: Milan _____
 Division: Design _____
 Mounting Type: Portable _____
 Mounting Location: Floor _____
 Subcategory: Floor _____

PHYSICAL

Shape: Oval _____
 Diameter (mm): 340 _____
 Diameter (in): 13 ³/₈ _____
 Height (mm): 1105 _____
 Height (in): 43 ¹/₂ _____
 Light Distribution: Omnidirectional _____
 Diffuser: Translucent Lampshade _____
 Fixture Finish: MBQ / VIW _____
 Fixture Material: Wood / Polyscreen _____

ELECTRICAL

Number of Lamps: 1 _____
 Lamp Type: LED Retrofit _____
 Lamp Shape: A19 _____
 Bulb Included: Bulb Not Included _____
 Max. Wattage Per Lamp (W): 12 _____
 Lamp Base: E26 _____
 Input Voltage (V): 120 _____
 Upon Request: 277Vac / GU24 _____

LED

OPTICAL

RATINGS AND CERTIFICATIONS

Certified By: CSA Certified to UL and CSA Standards _____
 IP rating: IP55 _____

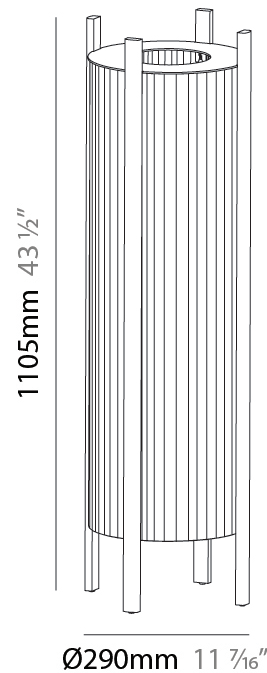

ROL PORTABLE

D94069-

PROJECT

TYPE

SPECIFIER

QUANTITY

DATE

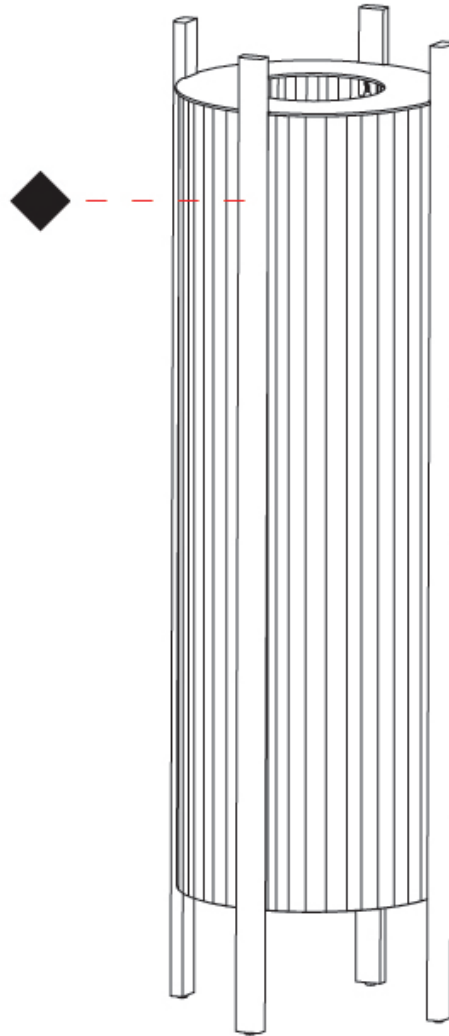

D

PROJECT
TYPE
SPECIFIER
QUANTITY
DATE

ROL PORTABLE

D94070-

base number Finish
Options

- To build a product code in our configurator select the specify button on the base model # product page
- To build a manual product code on this datasheet choose from the options listed below in blue font and add the suffix to the base model #

GENERAL

Series: Rol
 Brand: Milan
 Division: Design
 Mounting Type: Portable
 Mounting Location: Floor
 Subcategory: Floor

PHYSICAL

Shape: Abstract
 Diameter (mm): 290
 Diameter (in): 11 ⁷/₁₆
 Height (mm): 550
 Height (in): 21 ⁵/₈
 Light Distribution: Omnidirectional
 Diffuser: Translucent Lampshade
 Fixture Finish: MBQ / VIW
 Fixture Material: Wood / Polyscreen

ELECTRICAL

Number of Lamps: 1
 Lamp Type: LED Retrofit
 Lamp Shape: A19
 Bulb Included: Bulb Not Included
 Max. Wattage Per Lamp (W): 12
 Lamp Base: E26
 Input Voltage (V): 120
 Upon Request: 277Vac / GU24

LED

OPTICAL

RATINGS AND CERTIFICATIONS

Certified By: CSA Certified to UL and CSA Standards
 IP rating: IP55

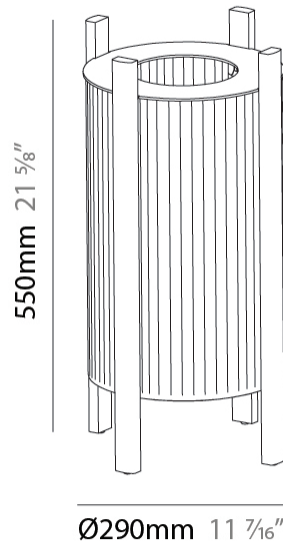

ROL PORTABLE

D94070-

PROJECT

TYPE

SPECIFIER

QUANTITY

DATE

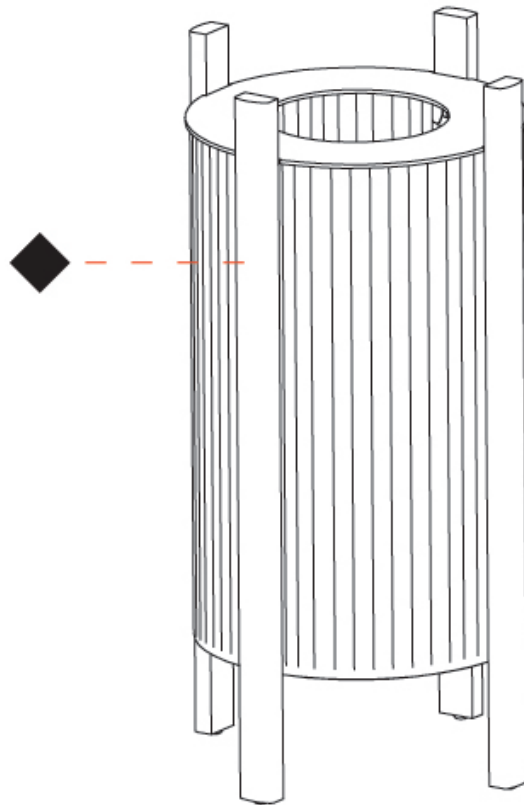

D

PROJECT
TYPE
SPECIFIER
QUANTITY
DATE

ROL PORTABLE

D94071-

base number Finish
Options

- To build a product code in our configurator select the specify button on the base model # product page
- To build a manual product code on this datasheet choose from the options listed below in blue font and add the suffix to the base model #

GENERAL

Series: Rol
 Brand: Milan
 Division: Design
 Mounting Type: Portable
 Mounting Location: Floor
 Subcategory: Floor

PHYSICAL

Shape: Abstract
 Diameter (mm): 390
 Diameter (in): 15 ³/₈
 Height (mm): 390
 Height (in): 17 ¹¹/₁₆
 Light Distribution: Omnidirectional
 Diffuser: Translucent Lampshade
 Fixture Finish: MBQ / VIW
 Fixture Material: Wood / Polyscreen

ELECTRICAL

Number of Lamps: 1
 Lamp Type: LED Retrofit
 Lamp Shape: A19
 Bulb Included: Bulb Not Included
 Max. Wattage Per Lamp (W): 12
 Lamp Base: E26
 Input Voltage (V): 120
 Upon Request: 277Vac / GU24

LED

OPTICAL

RATINGS AND CERTIFICATIONS

Certified By: CSA Certified to UL and CSA Standards
 IP rating: IP55

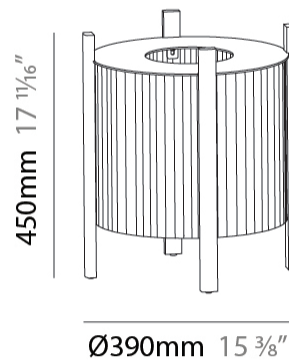
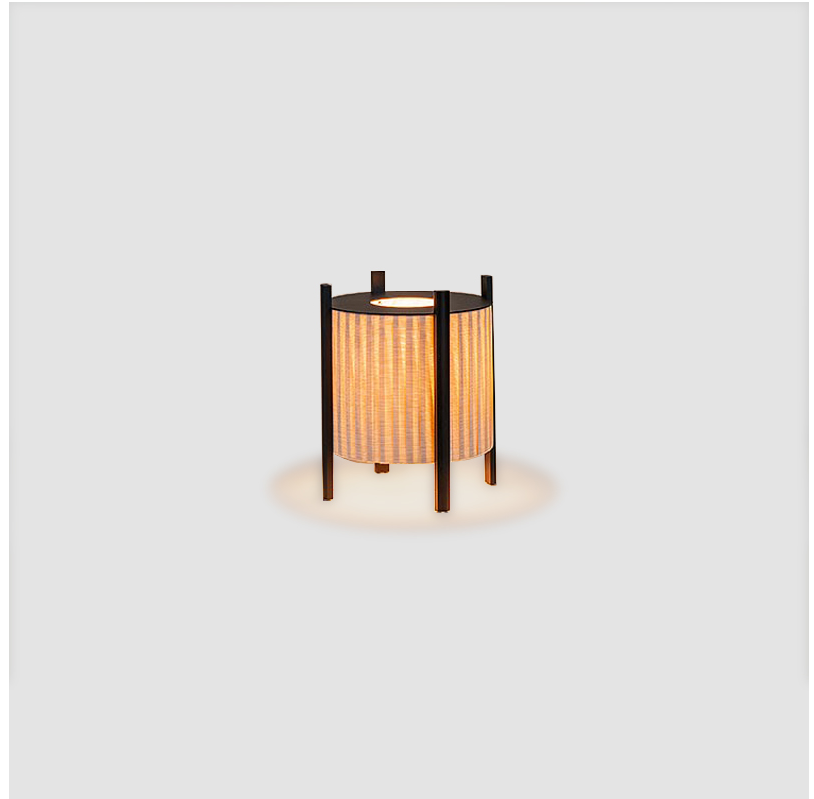

ROL PORTABLE

D94071-

PROJECT

TYPE

SPECIFIER

QUANTITY

DATE

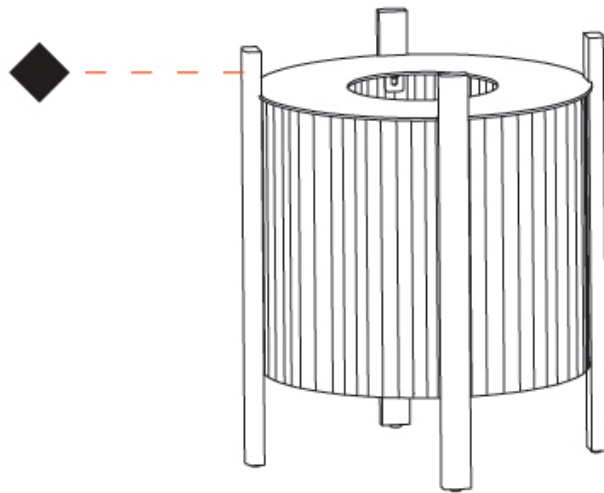

D

PROJECT

TYPE

SPECIFIER

QUANTITY

DATE

Fixture Finish

Matte Black Lacquer - MBQ

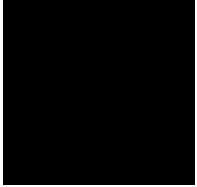

Digital: Not all screens are calibrated the same, and therefore, colors will appear differently between screens.

Physical: When texture is involved, there will be variations in color, character and tone within a product series and between product families.



ROL

LEGEND

	floor-mounted		pivotal		special LED (upon request) RGB, RGBW, tunable, gold+, meat+, art+, fashion+
	wall and ceiling: recessed and surface mounted		rotating		warm dim / natural dimming LED
	ceiling-mounted and wall-mounted		illuminate tilted		rechargeable battery powered
	wall-mounted		color of suspension cable		fixture with natural vivid LED (upon request)
	omni-directional light distribution		length of suspension cable		color rendering index
	direct light distribution		reflector degree selection		color temperature
	direct/indirect light distribution		super spot		lumen (luminous flux)
	indirect light distribution		lens		efficacy (lumens per watt)
	asymmetric light distribution		lens pack		Unified Glare Rating (UGR) range from 5-40
	aura light distribution		shine ring		marine grade (AISI 316 stainless steel)
	round wall or ceiling cut-out		integrated shine ring with diffuser		walk on
	square wall or ceiling cut-out		free individual colors 01-29		drive on
	the supplied jig specifies the cutout dimensions		individual colors: 00 (free of charge), 01-25 (extra charge)		Dark Sky Compliance
	minimum distance (meters) lamp - object		luminaire part to be colored (F1)		Americans with Disabilities Act (less than 4" off the wall located between 27"-84" from floor)
	recessed depth		luminaire part to be colored (F2)		lamp protected against explosion
	ceiling thickness in mm		luminaire part to be colored (F3)		blown glass using traditional methods by master glass blower
	ceiling thickness selection		luminaire part to be colored (F4)		acoustic material
	dimmable DP (phase), DV (0-10V), DD (dali), DS (step-dim)		luminaire part to be colored (F5)		protection class I, protection insulation
	included or excluded LED driver/transformer/control gear		color of 3-circuit adaptor		protection class II, protection insulation
	separately switchable		indirect diffuser		ETL Certified to UL and CSA Standards
	sensor		direct diffuser		UL Certified to UL and CSA Standards
	remote control		ball-proof (upon request)		CSA Certified to UL and CSA Standards
	available upon request		accessory		Certified for North American Standards

IP RATING

	protected against ingress of solid bodies greater than 12.5mm (finger)
	protected against ingress of solid bodies greater than 2.5mm protected against sprays of water up to 60 degrees from the vertical (rain)
	protected against ingress of solid bodies greater than 1mm (wire) no protection against the ingress of moisture
	protected against ingress of solid bodies greater than 1mm (wire) protected against sprays of water up to 60 degrees from the vertical (rain)
	protected against ingress of solid bodies greater than 1mm (wire) protected against water splashed from all directions
	protected against limited ingress of dust (wet rooms/covered outdoor areas) protected against water splashed from all directions
	protected against ingress of dust protected against jets of water
	protected against ingress of dust protected against powerful jets of water or heavy seas
	protected against ingress of dust protected against immersion of water between 15cm - 1m for 30 minutes
	protected against ingress of dust protected against immersion of water under pressure for long periods

IK RATING

	protected against 0.14 joules impact (equivalent to 0.25kg mass dropped from 56mm above the surface)
	protected against 0.2 joules impact (equivalent to 0.25kg mass dropped from 80mm above the surface)
	protected against 0.35 joules impact (equivalent to 0.25kg mass dropped from 140mm above the surface)
	protected against 0.5 joules impact (equivalent to 0.25kg mass dropped from 200mm above the surface)
	protected against 0.7 joules impact (equivalent to 0.25kg mass dropped from 280mm above the surface)
	protected against 1 joules impact (equivalent to 0.25kg mass dropped from 400mm above the surface)
	protected against 2 joules impact (equivalent to 0.5kg mass dropped from 400mm above the surface)
	protected against 5 joules impact (equivalent to 1.7kg mass dropped from 300mm above the surface)
	protected against 10 joules impact (equivalent to 5.0kg mass dropped from 200mm above the surface)
	protected against 20 joules impact (equivalent to 5.0kg mass dropped from 400mm above the surface)