

SENTO SURFACE

D113006- -

base number Finish Finish
 (Diamond) (Triangle)

- To build a product code in our configurator select the specify button on the base model # product page
- To build a manual product code on this datasheet choose from the options listed below in blue font and add the suffix to the base model #

GENERAL

Series: Sento
 Brand: Ole
 Division: Design
 Mounting Type: Surface
 Mounting Location: Wall
 Subcategory: Task

PHYSICAL

Shape: Bell
 Diameter (mm): 220
 Diameter (in): 8 ¹¹/₁₆
 Width (mm): 220
 Width (in): 8 ¹¹/₁₆
 Height (mm): 250
 Depth (mm): 800
 Height (in): 9 ¹³/₁₆
 Depth (in): 31 ¹/₂
 Extension (mm): 610
 Extension (in): 24
 Light Distribution: Direct
 Weight (kg): 1.5
 Weight (lbs): 3.3
 Diffuser:rylic - Satin
 Fixture Finish: WHI / MBK / BEI / MSA / OGR / MWH
 Holder Finish: WHI / MBK
 Fixture Material: Metal
 Cable Details: 3000mm Cable

ELECTRICAL

Number of Lamps: 1
 Lamp Type: LED Retrofit
 Lamp Shape: MR16
 Bulb Included: Bulb Not Included
 Max. Wattage Per Lamp (W): 7
 Lamp Base: GU10
 Input Voltage (V): 120

LED

OPTICAL

Adjustability: Rotating

RATINGS AND CERTIFICATIONS

Certified By: Certified for North American Standards
 IP rating: IP20

PROJECT	_____
TYPE	_____
SPECIFIER	_____
QUANTITY	_____
DATE	_____

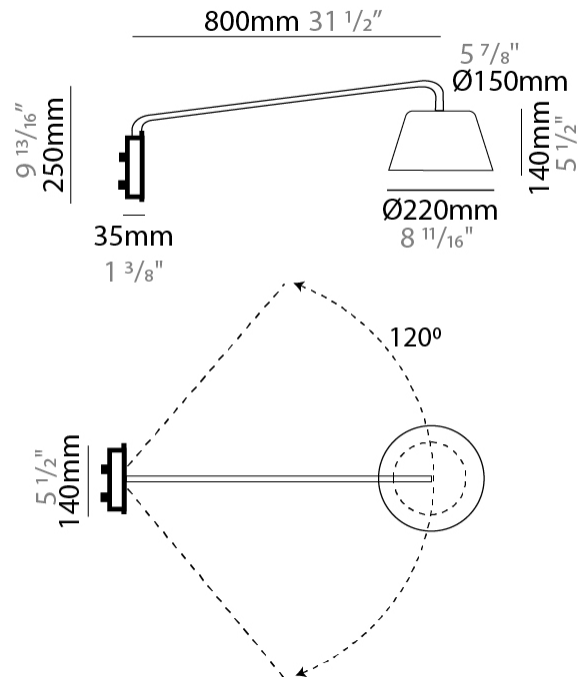

D113006-

PROJECT _____

TYPE _____

SPECIFIER _____

QUANTITY _____

DATE _____

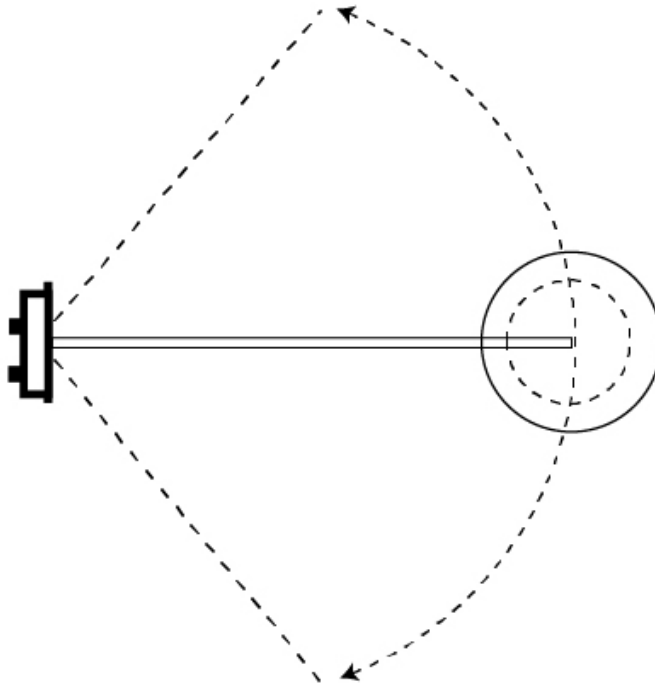
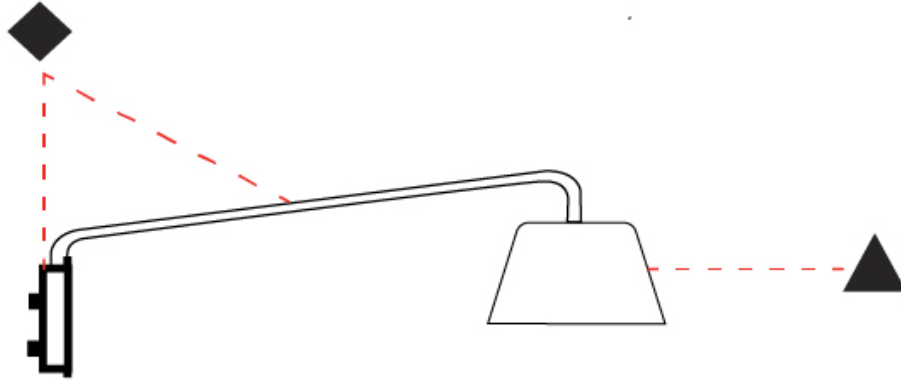

D

SENTO SURFACE

D113009- -

base number Finish Finish
 (Diamond) (Triangle)

- To build a product code in our configurator select the specify button on the base model # product page
- To build a manual product code on this datasheet choose from the options listed below in blue font and add the suffix to the base model #

GENERAL

Series: Sento
 Brand: Ole
 Division: Design
 Mounting Type: Surface
 Mounting Location: Wall
 Subcategory: Task

PHYSICAL

Shape: Bell
 Diameter (mm): 220
 Diameter (in): 8 ¹¹/₁₆
 Width (mm): 220
 Width (in): 8 ¹¹/₁₆
 Height (mm): 250
 Depth (mm): 500
 Height (in): 9 ¹³/₁₆
 Depth (in): 19 ¹¹/₁₆
 Extension (mm): 610
 Extension (in): 24
 Light Distribution: Direct
 Weight (kg): 1.4
 Weight (lbs): 3.1
 Diffuser:rylic - Satin
 Fixture Finish: WHI / MBK / BEI / MSA / OGR / MWH
 Holder Finish: WHI / MBK
 Fixture Material: Metal
 Cable Details: 3000mm Cable

ELECTRICAL

Number of Lamps: 1
 Lamp Type: LED Retrofit
 Lamp Shape: MR16
 Bulb Included: Bulb Not Included
 Max. Wattage Per Lamp (W): 7
 Lamp Base: GU10
 Input Voltage (V): 120

LED

OPTICAL

Adjustability: Rotating

RATINGS AND CERTIFICATIONS

Certified By: Certified for North American Standards
 IP rating: IP20

PROJECT
TYPE
SPECIFIER
QUANTITY
DATE

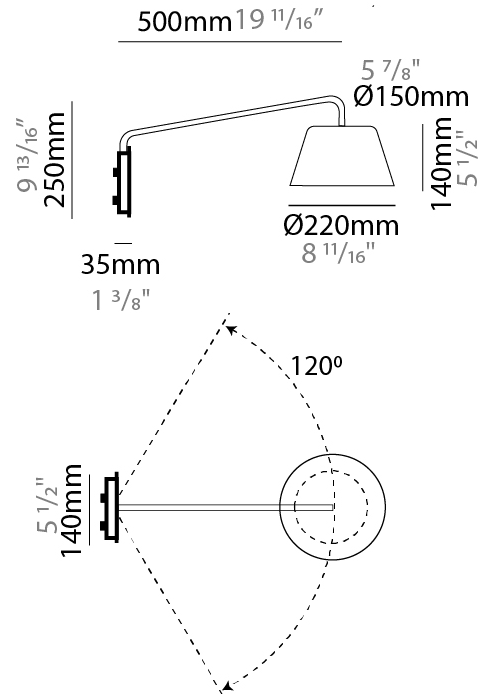

D113009-

PROJECT
TYPE
SPECIFIER
QUANTITY
DATE

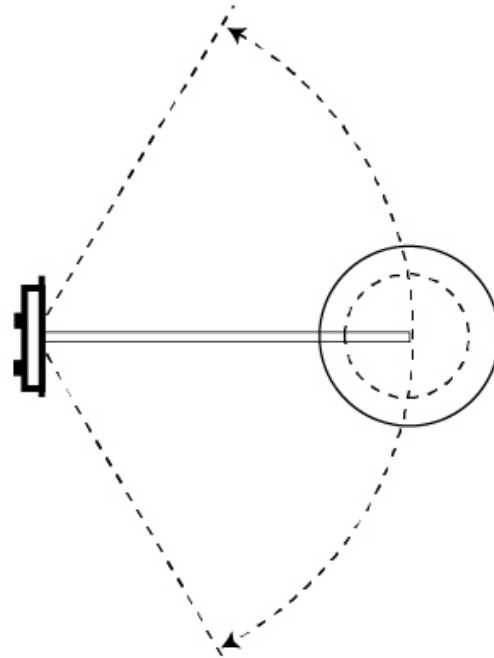
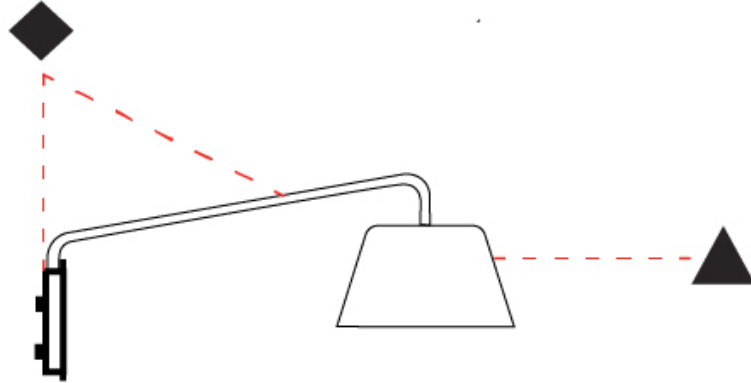

D

PROJECT	_____
TYPE	_____
SPECIFIER	_____
QUANTITY	_____
DATE	_____

Fixture Finish

White - WHI

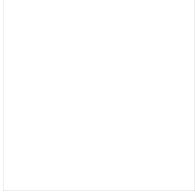

Matte Black - MBK



Beige - BEI

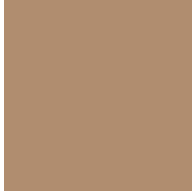

Marsala - MSA



Olive Green - OGR



Matte White - MWH

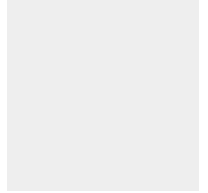

Holder Finish

White - WHI

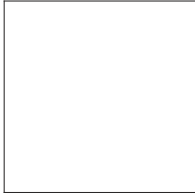

Matte Black - MBK



Digital: Not all screens are calibrated the same, and therefore, colors will appear differently between screens.

Physical: When texture is involved, there will be variations in color, character and tone within a product series and between product families.



COLOR FINISH CHART

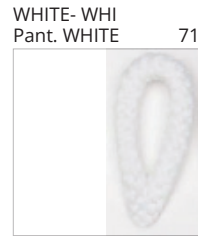
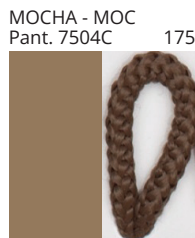
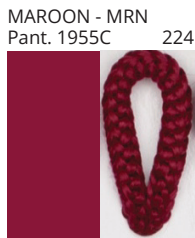
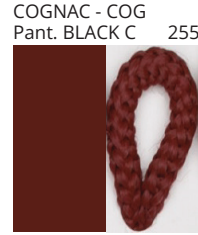

Digital: Not all screens are calibrated the same, and therefore, colors will appear differently between screens.
Physical: When texture is involved, there will be variations in color, character and tone within a product series and between product families.

COMPLETE COLOR FINISH CHART



Standard Colors with [S-]

Other fabric cord colors available upon request. Price increase and minimum quantities may apply

Digital: Not all screens are calibrated the same, and therefore, colors will appear differently between screens.

Physical: When texture is involved, there will be variations in color, character and tone within a product series and between product families.

Zaneen Group Inc. © 2024, T 1800-388-3382, F 416-247-9319, www.zaneen.com

Available for International specifications by adding 'INT' at the end of the existing Model #. For assistance on 'custom' specifications, contact zteam@zaneen.com.

In a constant effort to supply the best product, we reserve the right to change specifications or materials without notice. The most recent specification sheets are found at zaneen.com

COMPLETE COLOR FINISH CHART

JADE
 Pant. 3268C 311



VERDE BILLAR
 Pant. 340C 353



JUNGLA
 Pant. 356C 310



VERDE OSC.
 Pant. 3298C 358



MUSGO
 Pant. 5535C 320



S - DARK GREEN
 Pant. 5616C 301



S - OLIVE
 Pant. 5625C 323



CIRUELA
 Pant. 368C 104



LAVANDA
 Pant. 374C 2214



CRUDO
 Pant. 7401C 170



OPALE
 Pant. 402 1442



S - STONE - STN
 Pant. 7528C 1196



ASTRACAN
 Pant. 7529C 101



CAMELLO
 Pant. 731C 161



CASTANO
 Pant. 4625C 1674



TABACO
 Pant. 1545C 203



MARRON
 Pant. 476C 187



MARRON SUPER
 Pant. BLACK 4C 189



MADERA
 Pant. 7519C 2183



S - MOCHA
 Pant. 7504C 175



AVELLANA
 Pant. 729C 152



S - BEIGE - BEI
 Pant. 727C 196



ARENA
 Pant. 465C 151



BEIGE / CAMEL
 Pant. 1265C 154



Standard Colors with [S-]

Other fabric cord colors available upon request. Price increase and minimum quantities may apply

Digital: Not all screens are calibrated the same, and therefore, colors will appear differently between screens.

Physical: When texture is involved, there will be variations in color, character and tone within a product series and between product families.

Zaneen Group Inc. © 2024, T 1800-388-3382, F 416-247-9319, www.zaneen.com

Available for International specifications by adding 'INT' at the end of the existing Model #. For assistance on 'custom' specifications, contact zteam@zaneen.com.

In a constant effort to supply the best product, we reserve the right to change specifications or materials without notice. The most recent specification sheets are found at zaneen.com

COMPLETE COLOR FINISH CHART

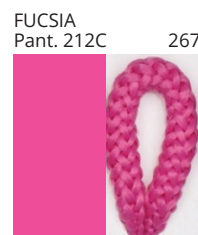
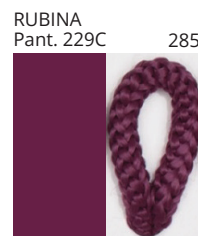
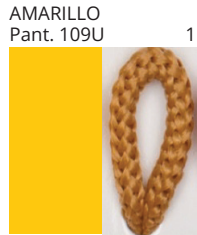

Standard Colors with [S-]

Other fabric cord colors available upon request. Price increase and minimum quantities may apply

Digital: Not all screens are calibrated the same, and therefore, colors will appear differently between screens.

Physical: When texture is involved, there will be variations in color, character and tone within a product series and between product families.

Zaneen Group Inc. © 2024, T 1800-388-3382, F 416-247-9319, www.zaneen.com

Available for International specifications by adding 'INT' at the end of the existing Model #. For assistance on 'custom' specifications, contact zteam@zaneen.com.

In a constant effort to supply the best product, we reserve the right to change specifications or materials without notice. The most recent specification sheets are found at zaneen.com

PROJECT _____
TYPE _____
NOTES _____
QUANTITY _____
DATE _____

COMPLETE COLOR FINISH CHART

ROSA PASTEL
Pant. 1905C 281



ALEJANDRIA
Pant. 196C 261



CANET
Pant. 2717C 43



MALVA
Pant. 2567C 141



AMORATADO
Pant. 265C 135



LAPIZLAZULI
Pant. 2745C 62



VIOLETA
Pant. 7676C 147



Standard Colors with [S-]

Other fabric cord colors available upon request. Price increase and minimum quantities may apply

Digital: Not all screens are calibrated the same, and therefore, colors will appear differently between screens.

Physical: When texture is involved, there will be variations in color, character and tone within a product series and between product families.





































































Zaneen Group Inc. © 2024, T 1800-388-3382, F 416-247-9319, www.zaneen.com

Available for International specifications by adding 'INT' at the end of the existing Model #. For assistance on 'custom' specifications, contact zteam@zaneen.com.











In a constant effort to supply the best product, we reserve the right to change specifications or materials without notice. The most recent specification sheets are found at zaneen.com

PROJECT	
TYPE	
SPECIFIER	
QUANTITY	
DATE	











LEGEND

 floor-mounted	 pivotable	 special LED (upon request) RGB, RGBW, tunable, gold+, meat+, art+, fashion+
 wall and ceiling: recessed and surface mounted	 rotating	 warm dim / natural dimming LED
 ceiling-mounted and wall-mounted	 illuminate tilted	 rechargeable battery powered
 wall-mounted	 color of suspension cable	 fixture with natural vivid LED (upon request)
 omni-directional light distribution	 length of suspension cable	 color rendering index
 direct light distribution	 reflector degree selection	 color temperature
 direct/indirect light distribution	 super spot	 lumen (luminous flux)
 indirect light distribution	 lens	 efficacy (lumens per watt)
 asymmetric light distribution	 lens pack	 Unified Glare Rating (UGR) range from 5-40
 aura light distribution	 shine ring	 marine grade (AISI 316 stainless steel)
 round wall or ceiling cut-out	 integrated shine ring with diffuser	 walk on
 square wall or ceiling cut-out	 free individual colors 01-29	 drive on
 the supplied jig specifies the cutout dimensions	 individual colors: 00 (free of charge), 01-25 (extra charge)	 Dark Sky Compliance
 minimum distance (meters) lamp - object	 luminaire part to be colored (F1)	 Americans with Disabilities Act (less than 4" off the wall located between 27"-84" from floor)
 recessed depth	 luminaire part to be colored (F2)	 lamp protected against explosion
 ceiling thickness in mm	 luminaire part to be colored (F3)	 blown glass using traditional methods by master glass blower
 ceiling thickness selection	 luminaire part to be colored (F4)	 acoustic material
 dimmable DP (phase), DV (0-10V), DD (dali), DS (step-dim)	 luminaire part to be colored (F5)	 protection class I, protection insulation
 included or excluded LED driver/transformer/control gear	 color of 3-circuit adaptor	 protection class II, protection insulation
 separately switchable	 indirect diffuser	 ETL Certified to UL and CSA Standards
 sensor	 direct diffuser	 UL Certified to UL and CSA Standards
 remote control	 ball-proof (upon request)	 CSA Certified to UL and CSA Standards
 available upon request	 accessory	 Certified for North American Standards

IP RATING

 IP20	protected against ingress of solid bodies greater than 12.5mm (finger)
 IP33	protected against ingress of solid bodies greater than 2.5mm protected against sprays of water up to 60 degrees from the vertical (rain)
 IP40	protected against ingress of solid bodies greater than 1mm (wire) no protection against the ingress of moisture
 IP43	protected against ingress of solid bodies greater than 1mm (wire) protected against sprays of water up to 60 degrees from the vertical (rain)
 IP44	protected against ingress of solid bodies greater than 1mm (wire) protected against water splashed from all directions
 IP54	protected against limited ingress of dust (wet rooms/covered outdoor areas) protected against water splashed from all directions
 IP65	protected against ingress of dust protected against jets of water
 IP66	protected against ingress of dust protected against powerful jets of water or heavy seas
 IP67	protected against ingress of dust protected against immersion of water between 15cm - 1m for 30 minutes
 IP68	protected against ingress of dust protected against immersion of water under pressure for long periods

IK RATING

 IK01	protected against 0.14 joules impact (equivalent to 0.25kg mass dropped from 56mm above the surface)
 IK02	protected against 0.2 joules impact (equivalent to 0.25kg mass dropped from 80mm above the surface)
 IK03	protected against 0.35 joules impact (equivalent to 0.25kg mass dropped from 140mm above the surface)
 IK04	protected against 0.5 joules impact (equivalent to 0.25kg mass dropped from 200mm above the surface)
 IK05	protected against 0.7 joules impact (equivalent to 0.25kg mass dropped from 280mm above the surface)
 IK06	protected against 1 joules impact (equivalent to 0.25kg mass dropped from 400mm above the surface)
 IK07	protected against 2 joules impact (equivalent to 0.5kg mass dropped from 400mm above the surface)
 IK08	protected against 5 joules impact (equivalent to 1.7kg mass dropped from 300mm above the surface)
 IK09	protected against 10 joules impact (equivalent to 5.0kg mass dropped from 200mm above the surface)
 IK10	protected against 20 joules impact (equivalent to 5.0kg mass dropped from 400mm above the surface)