

PROJECT	_____
TYPE	_____
SPECIFIER	_____
QUANTITY	_____
DATE	_____

## SHELL 6 SURFACE

### D42035-

base number          Finish           
Options         

- To build a product code in our configurator select the specify button on the base model # product page
- To build a manual product code on this datasheet choose from the options listed below in blue font and add the suffix to the base model #

#### GENERAL

Series: Shell \_\_\_\_\_  
 Subseries: Shell 6 \_\_\_\_\_  
 Brand: Icone \_\_\_\_\_  
 Division: Design \_\_\_\_\_  
 Mounting Type: Surface \_\_\_\_\_  
 Mounting Location: Ceiling \_\_\_\_\_  
 Subcategory: Downlight \_\_\_\_\_

#### PHYSICAL

Shape: Square \_\_\_\_\_  
 Length (mm): 340 \_\_\_\_\_  
 Length (in): 13 <sup>3</sup>/<sub>8</sub> \_\_\_\_\_  
 Width (mm): 340 \_\_\_\_\_  
 Width (in): 13 <sup>3</sup>/<sub>8</sub> \_\_\_\_\_  
 Height (mm): 30 \_\_\_\_\_  
 Height (in): 1 <sup>3</sup>/<sub>16</sub> \_\_\_\_\_  
 Light Distribution: Direct \_\_\_\_\_  
 Fixture Finish: WHI / BLK / GRY / GLF / SLF \_\_\_\_\_  
 Fixture Material: Aluminum \_\_\_\_\_

#### ELECTRICAL

Lamp Type: LED \_\_\_\_\_  
 Total Output Wattage (W): 27 \_\_\_\_\_  
 Dimming: Electronic Low Voltage Dimming \_\_\_\_\_  
 Input Voltage (V): 120Vac Direct Line \_\_\_\_\_

#### LED

Number of LEDs: 6 \_\_\_\_\_  
 Color Temperature (°K): 3000 \_\_\_\_\_  
 Nominal Lumen (lm): 2100 \_\_\_\_\_  
 CRI: >90 CRI \_\_\_\_\_  
 Lamp Life (hrs): 50000 \_\_\_\_\_

#### OPTICAL

#### RATINGS AND CERTIFICATIONS

Certified By: Certified for North American Standards \_\_\_\_\_  
 IP rating: IP20 \_\_\_\_\_

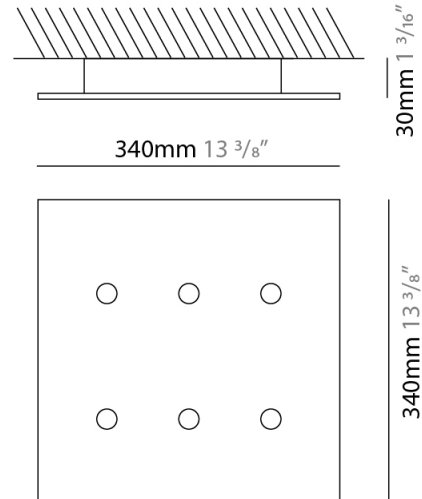
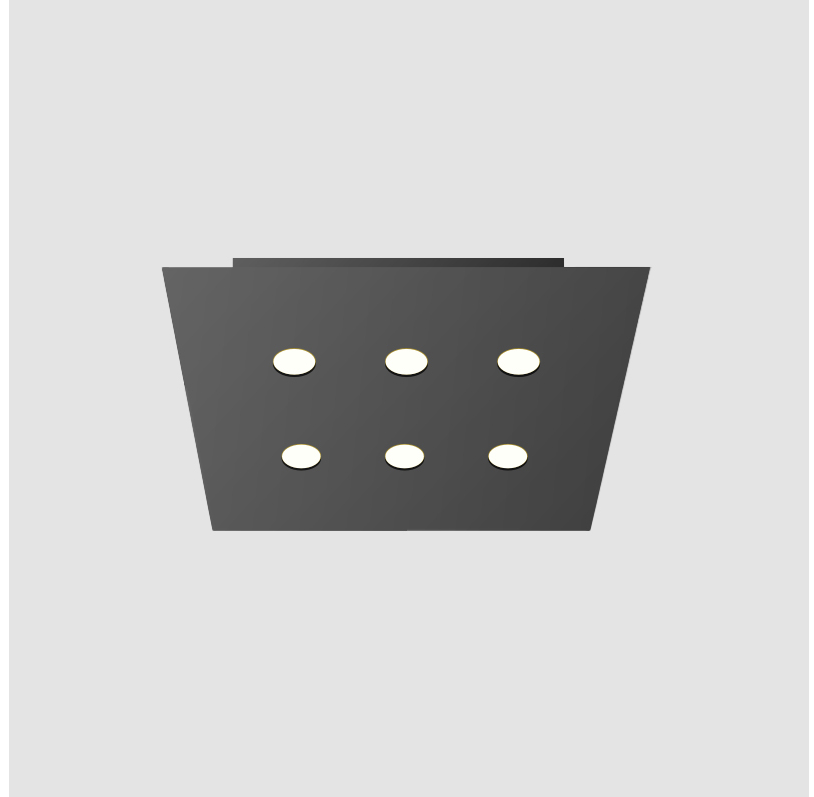

## SHELL 6 SURFACE

D42035-

PROJECT

TYPE

SPECIFIER

QUANTITY

DATE

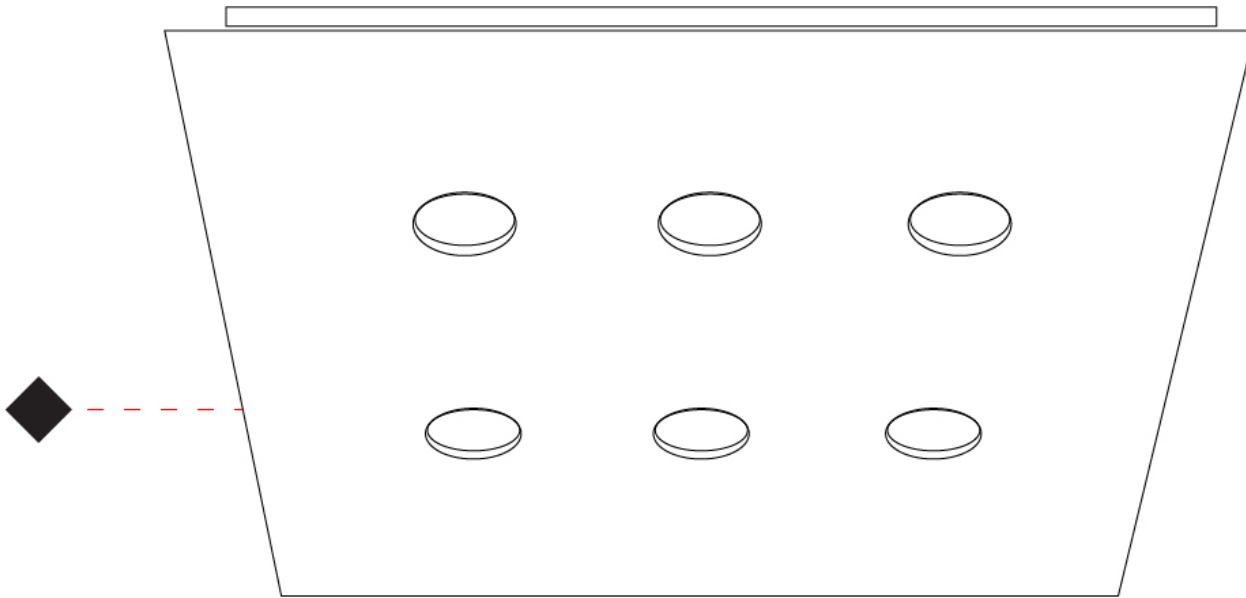

D

PROJECT
TYPE
SPECIFIER
QUANTITY
DATE

## SHELL 1 SURFACE

### D42038-

base number          Finish           
Options         

- To build a product code in our configurator select the specify button on the base model # product page
- To build a manual product code on this datasheet choose from the options listed below in blue font and add the suffix to the base model #

#### GENERAL

Series: Shell           
Subseries: Shell 1           
Brand: Icone           
Division: Design           
Mounting Type: Surface           
Mounting Location: Ceiling           
Subcategory: Downlight         

#### PHYSICAL

Shape: Square           
Length (mm): 145           
Length (in): 5 <sup>11</sup>/<sub>16</sub>           
Width (mm): 145           
Width (in): 5 <sup>11</sup>/<sub>16</sub>           
Height (mm): 30           
Height (in): 1 <sup>3</sup>/<sub>16</sub>           
Light Distribution: Direct           
[Fixture Finish: WHI / BLK / GRY / GLF / SLF](#)           
Fixture Material: Aluminum         

#### ELECTRICAL

Lamp Type: LED           
Total Output Wattage (W): 4.5           
Dimming: Electronic Low Voltage Dimming           
Input Voltage (V): 120Vac Direct Line         

#### LED

Number of LEDs: 1           
Color Temperature (°K): 3000           
Nominal Lumen (lm): 350           
CRI: >90 CRI           
Lamp Life (hrs): 50000         

#### OPTICAL

#### RATINGS AND CERTIFICATIONS

Certified By: Certified for North American Standards           
IP rating: IP20         

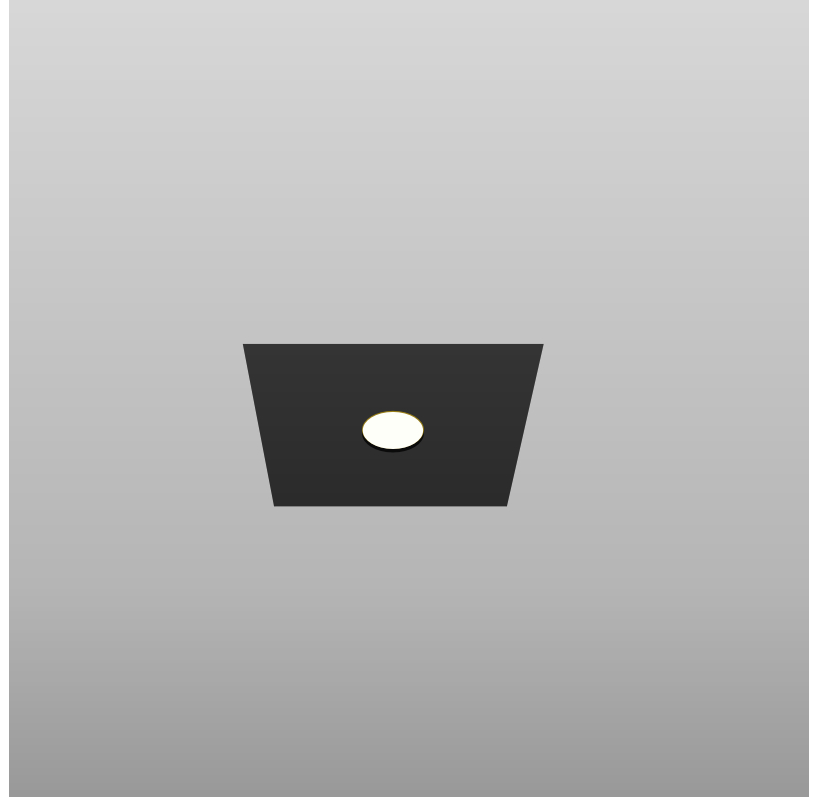

## SHELL 1 SURFACE

D42038-

PROJECT

TYPE

SPECIFIER

QUANTITY

DATE



PROJECT	
TYPE	
SPECIFIER	
QUANTITY	
DATE	

## SHELL 2 SURFACE

### D42039-

base number                      Finish                       
Options                     

- To build a product code in our configurator select the specify button on the base model # product page
- To build a manual product code on this datasheet choose from the options listed below in blue font and add the suffix to the base model #

#### GENERAL

Series: Shell                       
Subseries: Shell 2                       
Brand: Icone                       
Division: Design                       
Mounting Type: Surface                       
Mounting Location: Ceiling                       
Subcategory: Downlight                     

#### PHYSICAL

Shape: Square                       
Length (mm): 160                       
Length (in): 6 <sup>5</sup>/<sub>16</sub>                       
Width (mm): 160                       
Width (in): 6 <sup>5</sup>/<sub>16</sub>                       
Height (mm): 30                       
Height (in): 1 <sup>3</sup>/<sub>16</sub>                       
Light Distribution: Direct                       
[Fixture Finish: WHI / BLK / GRY / GLF / SLF](#)                       
Fixture Material: Aluminum                     

#### ELECTRICAL

Lamp Type: LED                       
Total Output Wattage (W): 9                       
Dimming: Electronic Low Voltage Dimming                       
Input Voltage (V): 120Vac Direct Line                     

#### LED

Number of LEDs: 2                       
Color Temperature (°K): 3000                       
Nominal Lumen (lm): 700                       
CRI: >90 CRI                       
Lamp Life (hrs): 50000                     

#### OPTICAL

#### RATINGS AND CERTIFICATIONS

Certified By: Certified for North American Standards                       
IP rating: IP20                     

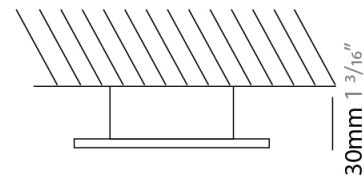
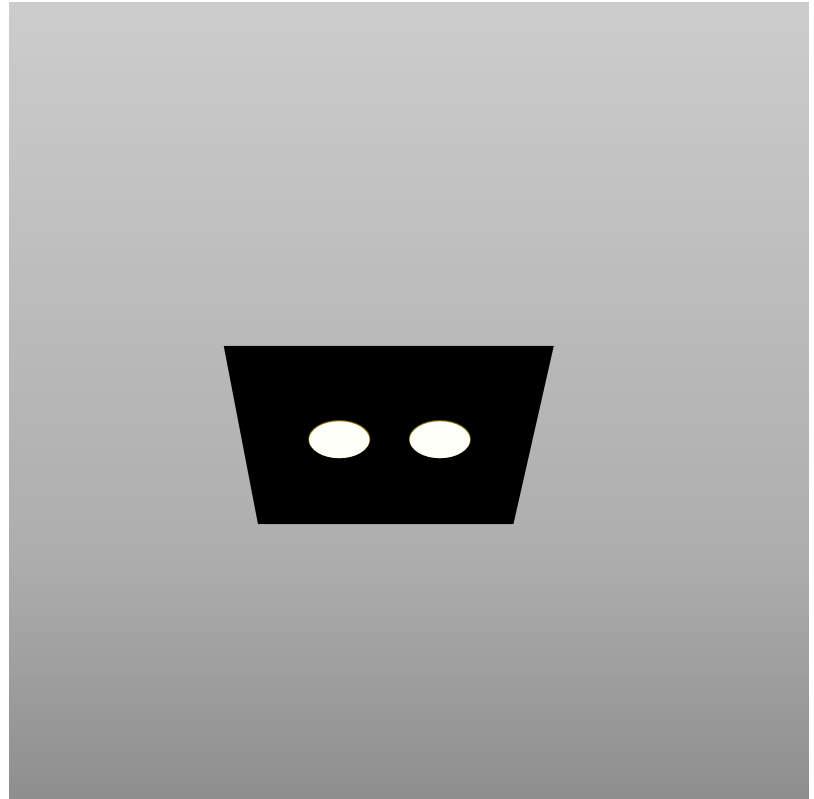

160mm 6 <sup>5</sup>/<sub>16</sub>"

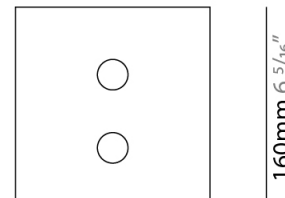

## SHELL 2 SURFACE

D42039-

PROJECT

TYPE

SPECIFIER

QUANTITY

DATE

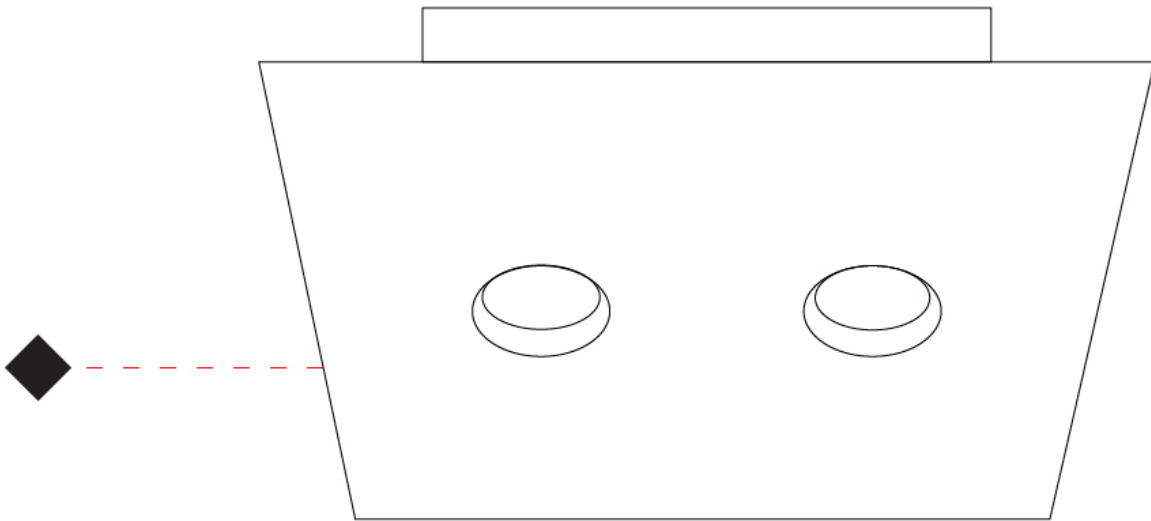

D

PROJECT	
TYPE	
SPECIFIER	
QUANTITY	
DATE	

## SHELL 4 SURFACE

### D42041-

base number            Finish             
Options           

- To build a product code in our configurator select the specify button on the base model # product page
- To build a manual product code on this datasheet choose from the options listed below in blue font and add the suffix to the base model #

#### GENERAL

Series: Shell             
Subseries: Shell 4             
Brand: Icone             
Division: Design             
Mounting Type: Surface             
Mounting Location: Ceiling             
Subcategory: Downlight           

#### PHYSICAL

Shape: Square             
Length (mm): 240             
Length (in): 9 7/16             
Width (mm): 240             
Width (in): 9 7/16             
Height (mm): 30             
Height (in): 1 3/16             
Light Distribution: Direct             
[Fixture Finish: WHI / BLK / GRY / GLF / SLF](#)             
Fixture Material: Aluminum           

#### ELECTRICAL

Lamp Type: LED             
Total Output Wattage (W): 18             
Dimming: Electronic Low Voltage Dimming             
Input Voltage (V): 120Vac Direct Line           

#### LED

Number of LEDs: 4             
Color Temperature (°K): 3000             
Nominal Lumen (lm): 1400             
CRI: >90 CRI             
Lamp Life (hrs): 50000           

#### OPTICAL

#### RATINGS AND CERTIFICATIONS

Certified By: Certified for North American Standards             
IP rating: IP20           

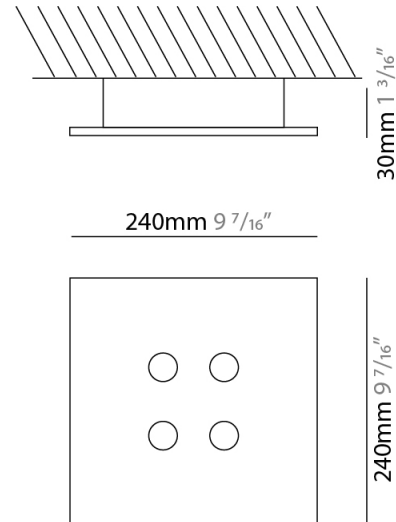

## SHELL 4 SURFACE

D42041-

PROJECT

TYPE

SPECIFIER

QUANTITY

DATE

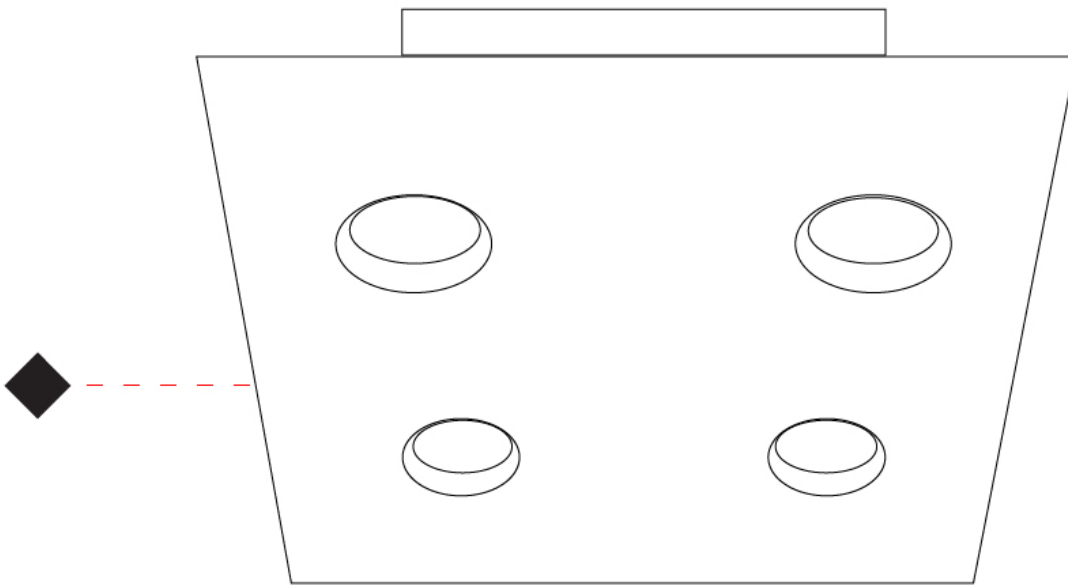

D



PROJECT \_\_\_\_\_  
 TYPE \_\_\_\_\_  
 SPECIFIER \_\_\_\_\_  
 QUANTITY \_\_\_\_\_  
 DATE \_\_\_\_\_

## SHELL 8 SURFACE

### D42042-

base number \_\_\_\_\_  
 Finish \_\_\_\_\_  
 Options \_\_\_\_\_

- To build a product code in our configurator select the specify button on the base model # product page
- To build a manual product code on this datasheet choose from the options listed below in blue font and add the suffix to the base model #

#### GENERAL

Series: Shell \_\_\_\_\_  
 Subseries: Shell 8 \_\_\_\_\_  
 Brand: Icone \_\_\_\_\_  
 Division: Design \_\_\_\_\_  
 Mounting Type: Surface \_\_\_\_\_  
 Mounting Location: Ceiling \_\_\_\_\_  
 Subcategory: Downlight \_\_\_\_\_

#### PHYSICAL

Shape: Square \_\_\_\_\_  
 Length (mm): 450 \_\_\_\_\_  
 Length (in): 17 <sup>11</sup>/<sub>16</sub> \_\_\_\_\_  
 Width (mm): 450 \_\_\_\_\_  
 Width (in): 17 <sup>11</sup>/<sub>16</sub> \_\_\_\_\_  
 Height (mm): 30 \_\_\_\_\_  
 Height (in): 1 <sup>3</sup>/<sub>16</sub> \_\_\_\_\_  
 Light Distribution: Direct \_\_\_\_\_  
 Fixture Finish: WHI / BLK / GRY / GLF / SLF \_\_\_\_\_  
 Fixture Material: Aluminum \_\_\_\_\_

#### ELECTRICAL

Lamp Type: LED \_\_\_\_\_  
 Input Wattage (W): 36 \_\_\_\_\_  
 Dimming: Electronic Low Voltage Dimming \_\_\_\_\_  
 Input Voltage (V): 120Vac Direct Line \_\_\_\_\_

#### LED

Number of LEDs: 8 \_\_\_\_\_  
 Color Temperature (°K): 3000 \_\_\_\_\_  
 Nominal Lumen (lm): 2800 \_\_\_\_\_  
 CRI: >90 CRI \_\_\_\_\_  
 Lamp Life (hrs): 50000 \_\_\_\_\_

#### OPTICAL

#### RATINGS AND CERTIFICATIONS

Certified By: Certified for North American Standards \_\_\_\_\_  
 IP rating: IP20 \_\_\_\_\_

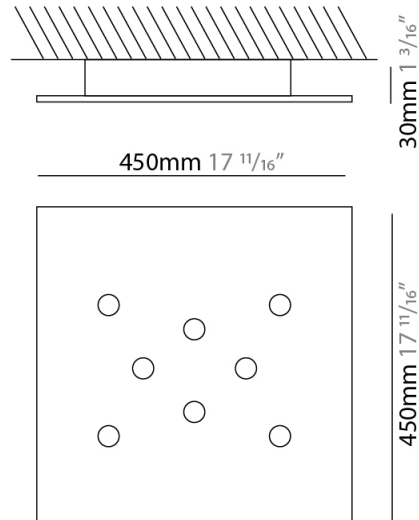

## SHELL 8 SURFACE

D42042-

PROJECT \_\_\_\_\_

TYPE \_\_\_\_\_

SPECIFIER \_\_\_\_\_

QUANTITY \_\_\_\_\_

DATE \_\_\_\_\_

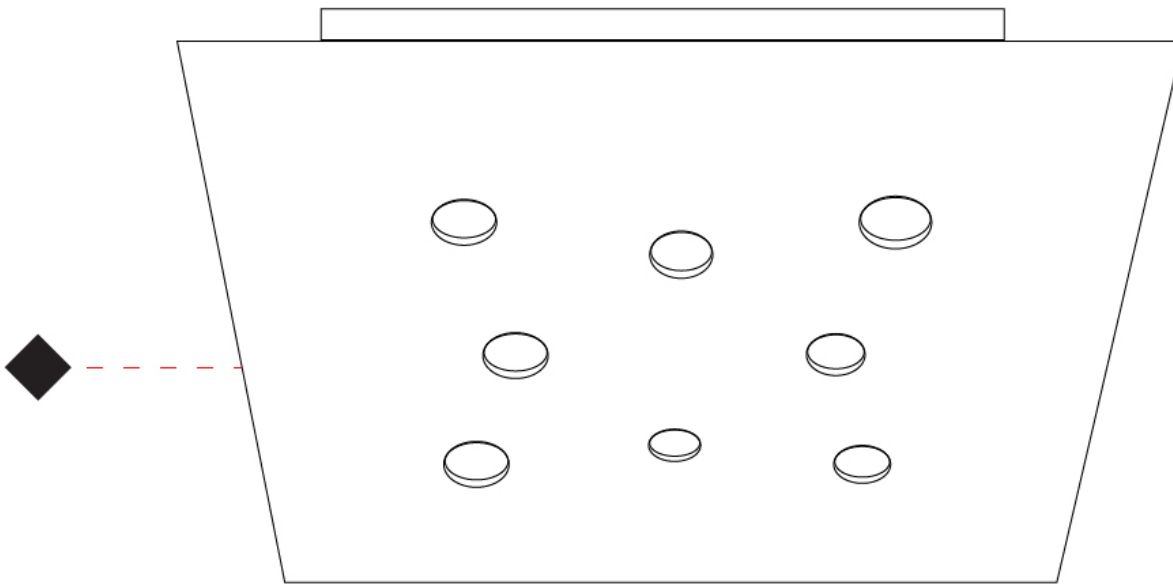

PROJECT
TYPE
SPECIFIER
QUANTITY
DATE

## SHELL 12 SURFACE

### D42069-

base number                      Finish                       
Options                     

- To build a product code in our configurator select the specify button on the base model # product page
- To build a manual product code on this datasheet choose from the options listed below in blue font and add the suffix to the base model #

#### GENERAL

Series: Shell                       
Subseries: Shell 12                       
Brand: Icone                       
Division: Design                       
Mounting Type: Surface                       
Mounting Location: Ceiling                       
Subcategory: Downlight                     

#### PHYSICAL

Shape: Square                       
Length (mm): 650                       
Length (in): 25 <sup>9</sup>/<sub>16</sub>                       
Width (mm): 650                       
Width (in): 25 <sup>9</sup>/<sub>16</sub>                       
Height (mm): 30                       
Height (in): 1 <sup>3</sup>/<sub>16</sub>                       
Light Distribution: Direct                       
[Fixture Finish: WHI / BLK / GRY / GLF / SLF](#)                       
Fixture Material: Aluminum                     

#### ELECTRICAL

Lamp Type: LED                       
Total Output Wattage (W): 54                       
Max. Wattage Per Lamp (W): 4.5                       
Dimming: Electronic Low Voltage Dimming                       
Input Voltage (V): 120Vac Direct Line                     

#### LED

Number of LEDs: 12                       
Color Temperature (°K): 3000                       
Nominal Lumen (lm): 4200                       
CRI: >90 CRI                       
Lamp Life (hrs): 50000                     

#### OPTICAL

#### RATINGS AND CERTIFICATIONS

Certified By: Certified for North American Standards                       
IP rating: IP20                     

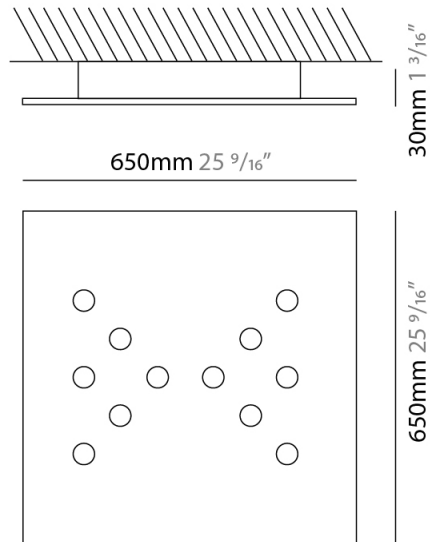

## SHELL 12 SURFACE

D42069-

PROJECT	_____
TYPE	_____
SPECIFIER	_____
QUANTITY	_____
DATE	_____

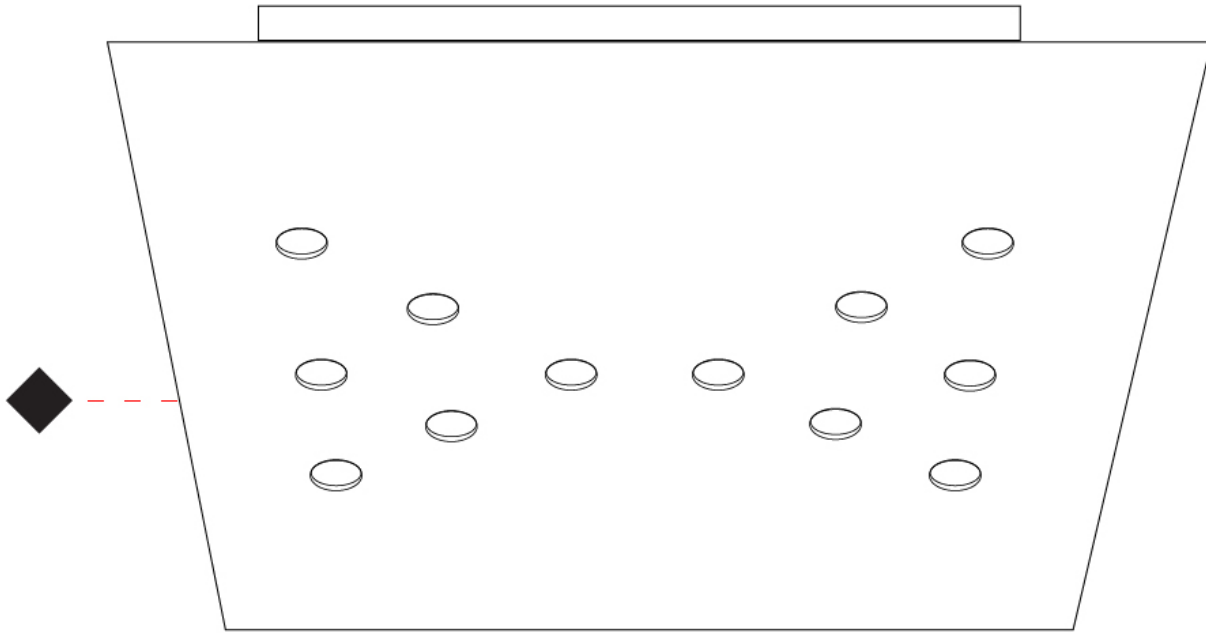

## SHELL COLOR FINISH CHART

PROJECT

TYPE

SPECIFIER

QUANTITY

DATE

### Fixture Finish

White - WHI

Black - BLK

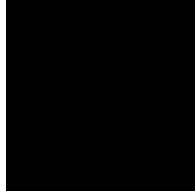

Gray - GRY

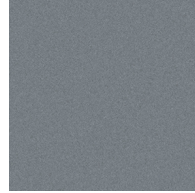

Gold Leaf - GLF



Silver Leaf - SLF



**Digital:** Not all screens are calibrated the same, and therefore, colors will appear differently between screens.

**Physical:** When texture is involved, there will be variations in color, character and tone within a product series and between product families.



PROJECT
TYPE
SPECIFIER
QUANTITY
DATE

### LEGEND

floor-mounted	pivotable	special LED (upon request) RGB, RGBW, tunable, gold+, meat+, art+, fashion+
wall and ceiling: recessed and surface mounted	rotating	warm dim / natural dimming LED
ceiling-mounted and wall-mounted	illuminate tilted	rechargeable battery powered
wall-mounted	color of suspension cable	fixture with natural vivid LED (upon request)
omni-directional light distribution	length of suspension cable	color rendering index
direct light distribution	reflector degree selection	color temperature
direct/indirect light distribution	super spot	lumen (luminous flux)
indirect light distribution	lens	efficacy (lumens per watt)
asymmetric light distribution	lens pack	Unified Glare Rating (UGR) range from 5-40
aura light distribution	shine ring	marine grade (AISI 316 stainless steel)
round wall or ceiling cut-out	integrated shine ring with diffuser	walk on
square wall or ceiling cut-out	free individual colors 01-29	drive on
the supplied jig specifies the cutout dimensions	individual colors: 00 (free of charge), 01-25 (extra charge)	Dark Sky Compliance
minimum distance (meters) lamp - object	luminaire part to be colored (F1)	Americans with Disabilities Act (less than 4" off the wall located between 27"-84" from floor)
recessed depth	luminaire part to be colored (F2)	lamp protected against explosion
ceiling thickness in mm	luminaire part to be colored (F3)	blown glass using traditional methods by master glass blower
ceiling thickness selection	luminaire part to be colored (F4)	acoustic material
dimmable DP (phase), DV (0-10V), DD (dali), DS (step-dim)	luminaire part to be colored (F5)	protection class I, protection insulation
included or excluded LED driver/transformer/control gear	color of 3-circuit adaptor	protection class II, protection insulation
separately switchable	indirect diffuser	ETL Certified to UL and CSA Standards
sensor	direct diffuser	UL Certified to UL and CSA Standards
remote control	ball-proof (upon request)	CSA Certified to UL and CSA Standards
available upon request	accessory	Certified for North American Standards

### IP RATING

IP20	protected against ingress of solid bodies greater than 12.5mm (finger)
IP33	protected against ingress of solid bodies greater than 2.5mm protected against sprays of water up to 60 degrees from the vertical (rain)
IP40	protected against ingress of solid bodies greater than 1mm (wire) no protection against the ingress of moisture
IP43	protected against ingress of solid bodies greater than 1mm (wire) protected against sprays of water up to 60 degrees from the vertical (rain)
IP44	protected against ingress of solid bodies greater than 1mm (wire) protected against water splashed from all directions
IP54	protected against limited ingress of dust (wet rooms/covered outdoor areas) protected against water splashed from all directions
IP65	protected against ingress of dust protected against jets of water
IP66	protected against ingress of dust protected against powerful jets of water or heavy seas
IP67	protected against ingress of dust protected against immersion of water between 15cm - 1m for 30 minutes
IP68	protected against ingress of dust protected against immersion of water under pressure for long periods

### IK RATING

IK01	protected against 0.14 joules impact (equivalent to 0.25kg mass dropped from 56mm above the surface)
IK02	protected against 0.2 joules impact (equivalent to 0.25kg mass dropped from 80mm above the surface)
IK03	protected against 0.35 joules impact (equivalent to 0.25kg mass dropped from 140mm above the surface)
IK04	protected against 0.5 joules impact (equivalent to 0.25kg mass dropped from 200mm above the surface)
IK05	protected against 0.7 joules impact (equivalent to 0.25kg mass dropped from 280mm above the surface)
IK06	protected against 1 joules impact (equivalent to 0.25kg mass dropped from 400mm above the surface)
IK07	protected against 2 joules impact (equivalent to 0.5kg mass dropped from 400mm above the surface)
IK08	protected against 5 joules impact (equivalent to 1.7kg mass dropped from 300mm above the surface)
IK09	protected against 10 joules impact (equivalent to 5.0kg mass dropped from 200mm above the surface)
IK10	protected against 20 joules impact (equivalent to 5.0kg mass dropped from 400mm above the surface)