

## SIRIO DISC SUSPENSION

### D101678-

base number    LED Dimming    Color Temperature    Finish Options

- To build a product code in our configurator select the specify button on the base model # product page
- To build a manual product code on this datasheet choose from the options listed below in blue font and add the suffix to the base model #

#### GENERAL

Series: Sirio  
 Subseries: Sirio Disc  
 Brand: Quasar  
 Division: Design  
 Mounting Type: Suspension  
 Mounting Location: Ceiling  
 Subcategory: Ambient

#### PHYSICAL

Shape: Abstract  
 Diameter (mm): 700  
 Diameter (in): 27 9/16  
 Height (mm): 300  
 Height (in): 11 13/16  
 Max. Overall Height (mm): 2300  
 Max. Overall Height (in): 90 9/16  
 Light Distribution: Omnidirectional  
 Weight (kg): 3.5  
 Weight (lbs): 7.7  
[Fixture Finish: NIC / BRA / BBR](#)  
 Fixture Material: Metal  
 Cable Details: 2000mm Cable  
 Upon Request: Custom Sizes

#### ELECTRICAL

Lamp Type: LED  
 Input Wattage (W): 30  
[Dimming: Non-Dimming / Phase Dimming \(120vac Only\)](#)  
 Driver Included: Yes  
 Driver Location: Integrated  
 Driver Type: Constant Voltage - 120/277Vac  
 Driver Class: Class 2  
 Input Voltage (V): 120 - 277  
 Output Voltage (V): 12  
 Upon Request: (Not included - see components) Integral: 0-10Vdc dimming

#### LED

Number of LEDs: 50  
[Color Temperature \(°K\): 2400 / 2800](#)  
 Max. Delivered Lumen (lm): 2100 (2800K)  
 CRI: >90 CRI  
 Lamp Life (hrs): 50000

#### OPTICAL

#### RATINGS AND CERTIFICATIONS

Certified By: Certified for North American Standards  
 IP rating: IP20

PROJECT	_____
TYPE	_____
SPECIFIER	_____
QUANTITY	_____
DATE	_____

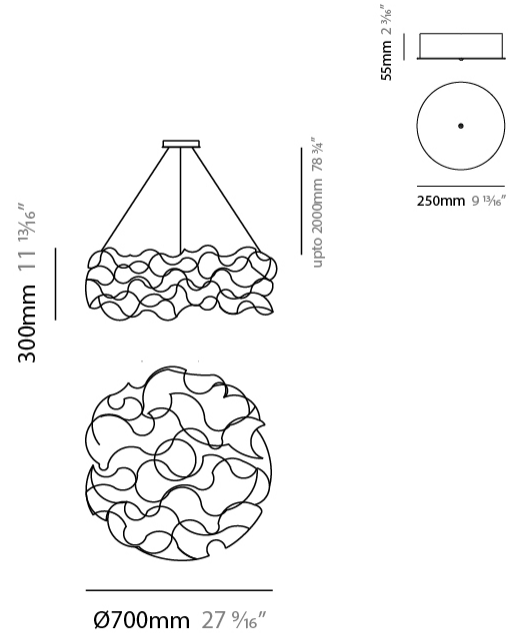

## SIRIO DISC SUSPENSION

D101678-

PROJECT

TYPE

SPECIFIER

QUANTITY

DATE

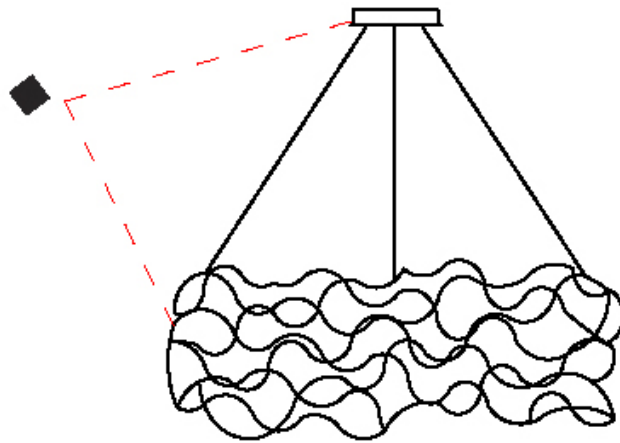

D

## SIRIO DISC SUSPENSION

### D101679-

base number    LED Dimming    Color Temperature    Finish Options

- To build a product code in our configurator select the specify button on the base model # product page
- To build a manual product code on this datasheet choose from the options listed below in blue font and add the suffix to the base model #

#### GENERAL

Series: Sirio  
 Subseries: Sirio Disc  
 Brand: Quasar  
 Division: Design  
 Mounting Type: Suspension  
 Mounting Location: Ceiling  
 Subcategory: Ambient

#### PHYSICAL

Shape: Abstract  
 Diameter (mm): 1300  
 Diameter (in): 51 <sup>3</sup>/<sub>16</sub>"  
 Height (mm): 400  
 Height (in): 15 <sup>3</sup>/<sub>4</sub>"  
 Max. Overall Height (mm): 2400  
 Max. Overall Height (in): 94 <sup>1</sup>/<sub>2</sub>"  
 Light Distribution: Omnidirectional  
 Weight (kg): 6.5  
 Weight (lbs): 14.3  
[Fixture Finish: NIC / BRA / BBR](#)  
 Fixture Material: Metal  
 Cable Details: 2000mm Cable  
 Upon Request: Custom Sizes

#### ELECTRICAL

Lamp Type: LED  
 Input Wattage (W): 78  
[Dimming: Non-Dimming / Phase Dimming \(120vac Only\)](#)  
 Driver Included: Yes  
 Driver Location: Integrated  
 Driver Type: Constant Voltage - 120/277Vac  
 Driver Class: Class 2  
 Input Voltage (V): 120 - 277  
 Output Voltage (V): 12  
 Upon Request: (Not included - see components) Integral: 0-10Vdc dimming

#### LED

Number of LEDs: 130  
[Color Temperature \(°K\): 2400 / 2800](#)  
 Max. Delivered Lumen (lm): 3900 (2800K)  
 CRI: >90 CRI  
 Lamp Life (hrs): 50000

#### OPTICAL

#### RATINGS AND CERTIFICATIONS

Certified By: Certified for North American Standards  
 IP rating: IP20

PROJECT
TYPE
SPECIFIER
QUANTITY
DATE

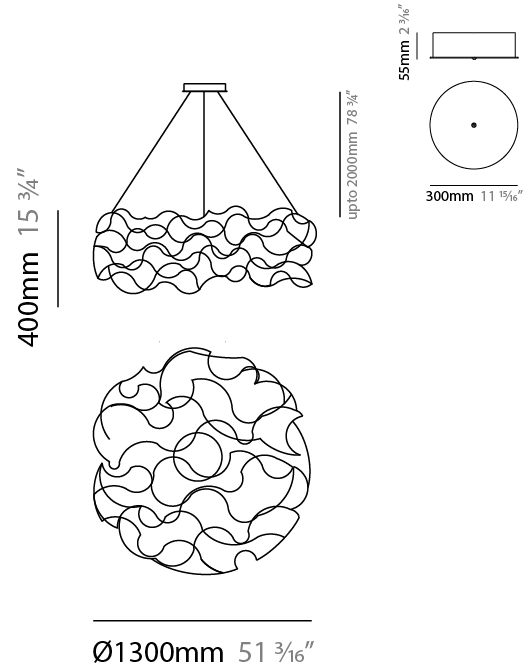

## SIRIO DISC SUSPENSION

D101679-

PROJECT

TYPE

SPECIFIER

QUANTITY

DATE

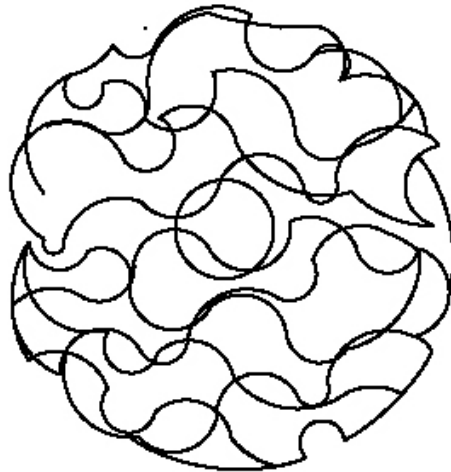
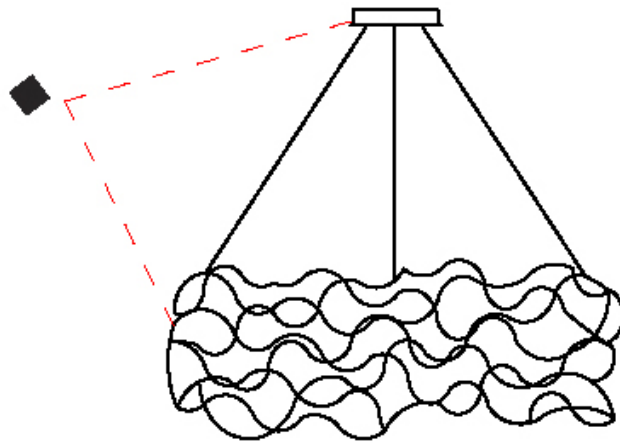

D

## SIRIO DISC SUSPENSION

### D101680-

base number    LED Dimming    Color Temperature    Finish Options

- To build a product code in our configurator select the specify button on the base model # product page
- To build a manual product code on this datasheet choose from the options listed below in blue font and add the suffix to the base model #

#### GENERAL

Series: Sirio  
 Subseries: Sirio Disc  
 Brand: Quasar  
 Division: Design  
 Mounting Type: Suspension  
 Mounting Location: Ceiling  
 Subcategory: Ambient

#### PHYSICAL

Shape: Abstract  
 Diameter (mm): 2000  
 Diameter (in): 78 3/4  
 Height (mm): 400  
 Height (in): 15 3/4  
 Max. Overall Height (mm): 2400  
 Max. Overall Height (in): 94 1/2  
 Light Distribution: Omnidirectional  
 Weight (kg): 6  
 Weight (lbs): 13.2  
[Fixture Finish: NIC / BRA / BBR](#)  
 Fixture Material: Metal  
 Cable Details: 2000mm Cable  
 Upon Request: Custom Sizes

#### ELECTRICAL

Lamp Type: LED  
 Input Wattage (W): 120  
[Dimming: Non-Dimming / Phase Dimming \(120vac Only\)](#)  
 Driver Included: Yes  
 Driver Location: Integrated  
 Driver Type: Constant Voltage - 120/277Vac  
 Driver Class: Class 2  
 Input Voltage (V): 120 - 277  
 Output Voltage (V): 12

#### LED

Number of LEDs: 200  
[Color Temperature \(°K\): 2400 / 2800](#)  
 Max. Delivered Lumen (lm): 6000 (2800K)  
 CRI: >90 CRI  
 Lamp Life (hrs): 50000

#### OPTICAL

#### RATINGS AND CERTIFICATIONS

Certified By: Certified for North American Standards  
 IP rating: IP20

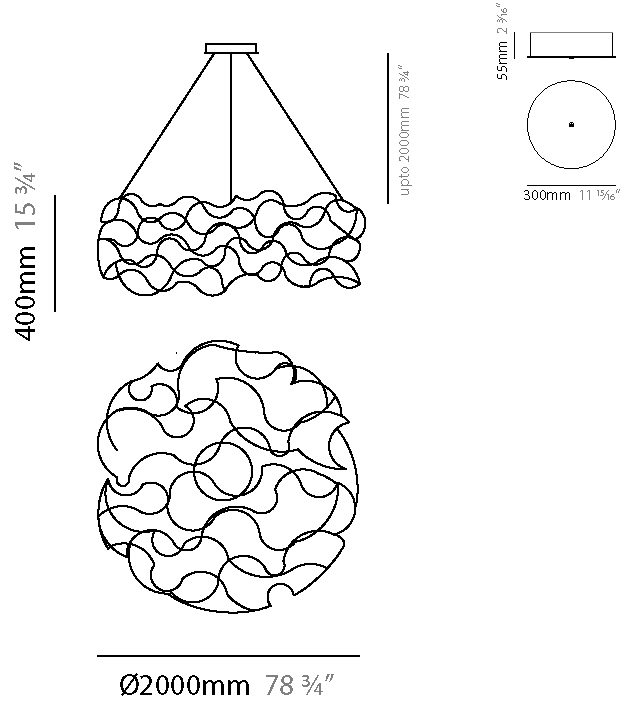

## SIRIO DISC SUSPENSION

D101680-

PROJECT

TYPE

SPECIFIER

QUANTITY

DATE

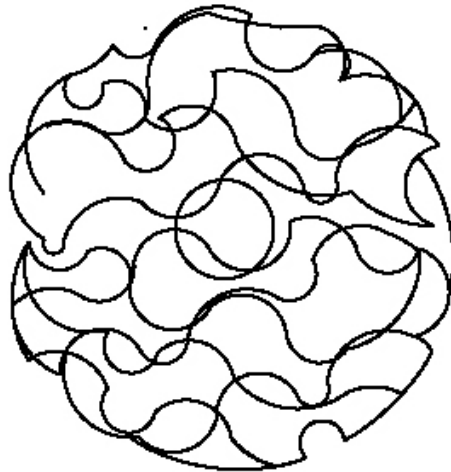
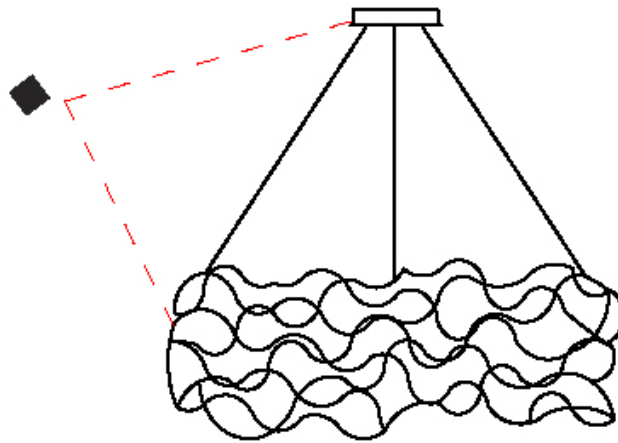

D

## SIRIO ABSTRACT SUSPENSION

### D101681-

base number    LED Dimming    Color Temperature    Finish Options

- To build a product code in our configurator select the specify button on the base model # product page
- To build a manual product code on this datasheet choose from the options listed below in blue font and add the suffix to the base model #

#### GENERAL

Series: Sirio  
 Subseries: Sirio Abstract  
 Brand: Quasar  
 Division: Design  
 Mounting Type: Suspension  
 Mounting Location: Ceiling  
 Subcategory: Ambient

#### PHYSICAL

Shape: Abstract  
 Length (mm): 1250  
 Length (in): 49 3/16  
 Width (mm): 400  
 Width (in): 15 3/4  
 Height (mm): 400  
 Height (in): 15 3/4  
 Max. Overall Height (mm): 2400  
 Max. Overall Height (in): 94 1/2  
 Light Distribution: Omnidirectional  
 Weight (kg): 4  
 Weight (lbs): 8.8  
 Fixture Finish: [NIC / BRA / BBR](#)  
 Fixture Material: Metal  
 Cable Details: 2000mm Cable  
 Upon Request: Custom Sizes

#### ELECTRICAL

Lamp Type: LED  
 Input Wattage (W): 30  
 Dimming: [Non-Dimming / Phase Dimming \(120vac Only\)](#)  
 Driver Included: Yes  
 Driver Location: Integrated  
 Driver Type: Constant Voltage - 120/277Vac  
 Driver Class: Class 2  
 Input Voltage (V): 120 - 277  
 Output Voltage (V): 12  
 Upon Request: (Not included - see components) Integral: 0-10Vdc dimming

#### LED

Number of LEDs: 50  
 Color Temperature (°K): [2400 / 2800](#)  
 Max. Delivered Lumen (lm): 1500 (2800K)  
 CRI: >90 CRI  
 Lamp Life (hrs): 50000

#### OPTICAL

#### RATINGS AND CERTIFICATIONS

Certified By: Certified for North American Standards  
 IP rating: IP20

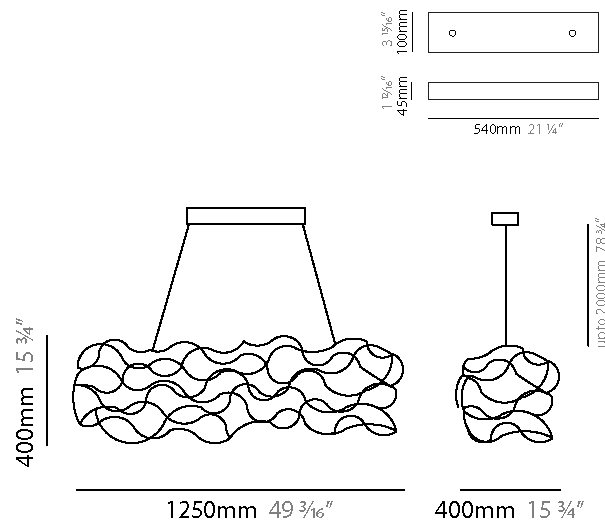

## SIRIO ABSTRACT SUSPENSION

D101681-

PROJECT \_\_\_\_\_

TYPE \_\_\_\_\_

SPECIFIER \_\_\_\_\_

QUANTITY \_\_\_\_\_

DATE \_\_\_\_\_

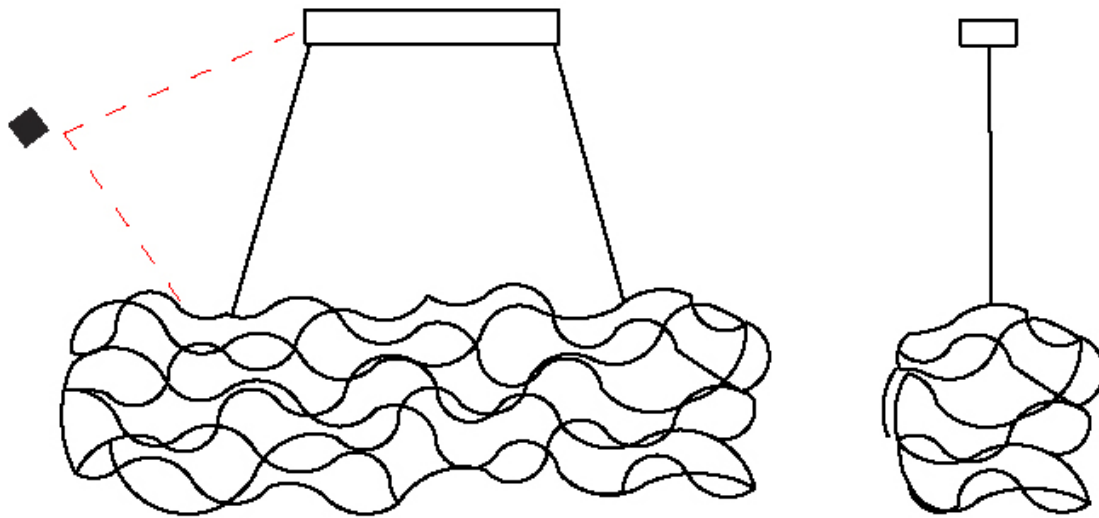

D



## SIRIO ABSTRACT SUSPENSION

### D101682-

base number    LED Dimming    Color Temperature    Finish Options

- To build a product code in our configurator select the specify button on the base model # product page
- To build a manual product code on this datasheet choose from the options listed below in blue font and add the suffix to the base model #

#### GENERAL

Series: Sirio  
 Subseries: Sirio Abstract  
 Brand: Quasar  
 Division: Design  
 Mounting Type: Suspension  
 Mounting Location: Ceiling  
 Subcategory: Ambient

#### PHYSICAL

Shape: Abstract  
 Length (mm): 1800  
 Length (in): 70 <sup>7</sup>/<sub>8</sub>  
 Width (mm): 400  
 Width (in): 15 <sup>3</sup>/<sub>4</sub>  
 Height (mm): 400  
 Height (in): 15 <sup>3</sup>/<sub>4</sub>  
 Max. Overall Height (mm): 2400  
 Max. Overall Height (in): 94 <sup>1</sup>/<sub>2</sub>  
 Light Distribution: Omnidirectional  
 Weight (kg): 4.5  
 Weight (lbs): 9.9  
 Fixture Finish: [NIC / BRA / BBR](#)  
 Fixture Material: Metal  
 Cable Details: 2000mm Cable  
 Upon Request: Custom Sizes

#### ELECTRICAL

Lamp Type: LED  
 Input Wattage (W): 42  
 Dimming: [Non-Dimming / Phase Dimming \(120vac Only\)](#)  
 Driver Included: Yes  
 Driver Location: Integrated  
 Driver Type: Constant Voltage - 120/277Vac  
 Driver Class: Class 2  
 Input Voltage (V): 120 - 277  
 Output Voltage (V): 12  
 Upon Request: (Not included - see components) Integral: 0-10Vdc dimming

#### LED

Number of LEDs: 70  
 Color Temperature (°K): [2400 / 2800](#)  
 Max. Delivered Lumen (lm): 2100 (2800K)  
 CRI: >90 CRI  
 Lamp Life (hrs): 50000

#### OPTICAL

#### RATINGS AND CERTIFICATIONS

Certified By: Certified for North American Standards  
 IP rating: IP20

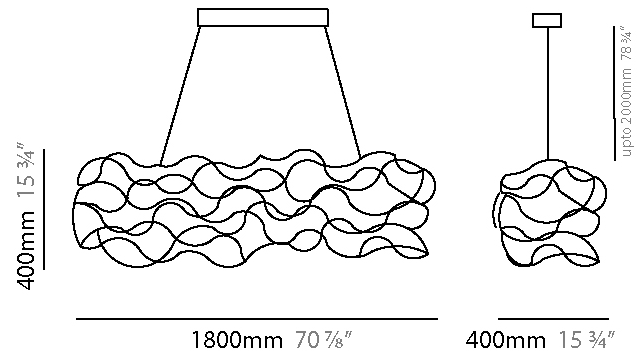
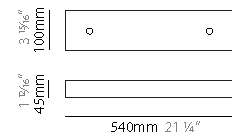

## SIRIO ABSTRACT SUSPENSION

D101682-

PROJECT

TYPE

SPECIFIER

QUANTITY

DATE

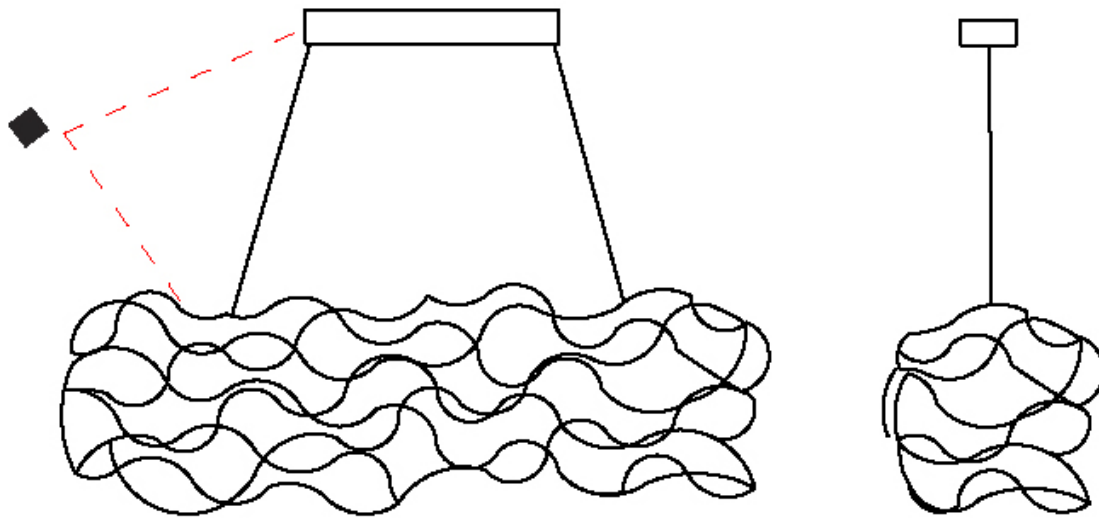

D

PROJECT	_____
TYPE	_____
SPECIFIER	_____
QUANTITY	_____
DATE	_____

## SIRIO ABSTRACT SUSPENSION

### D101683-

base number	LED	Color	Finish
	Dimming	Temperature	Options

- To build a product code in our configurator select the specify button on the base model # product page
- To build a manual product code on this datasheet choose from the options listed below in blue font and add the suffix to the base model #

#### GENERAL

Series: Sirio
Subseries: Sirio Abstract
Brand: Quasar
Division: Design
Mounting Type: Suspension
Mounting Location: Ceiling
Subcategory: Ambient

#### PHYSICAL

Shape: Abstract
Length (mm): 2000
Length (in): 78 3/4
Width (mm): 400
Width (in): 15 3/4
Height (mm): 400
Height (in): 15 3/4
Max. Overall Height (mm): 2400
Max. Overall Height (in): 94 1/2
Light Distribution: Omnidirectional
Weight (kg): 4.5
Weight (lbs): 9.9
Fixture Finish: <a href="#">NIC</a> / <a href="#">BRA</a> / <a href="#">BBR</a>
Fixture Material: Metal
Cable Details: 2000mm Cable
Upon Request: Custom Sizes

#### ELECTRICAL

Lamp Type: LED
Input Wattage (W): 48
Dimming: <a href="#">Non-Dimming / Phase Dimming (120vac Only)</a>
Driver Included: Yes
Driver Location: Integrated
Driver Type: Constant Voltage - 120/277Vac
Driver Class: Class 2
Input Voltage (V): 120 - 277
Output Voltage (V): 12
Upon Request: (Not included - see components) Integral: 0-10Vdc dimming

#### LED

Number of LEDs: 80
Color Temperature (°K): <a href="#">2400</a> / <a href="#">2800</a>
Max. Delivered Lumen (lm): 2400 (2800K)
CRI: >90 CRI
Lamp Life (hrs): 50000

#### OPTICAL

#### RATINGS AND CERTIFICATIONS

Certified By: Certified for North American Standards
IP rating: IP20

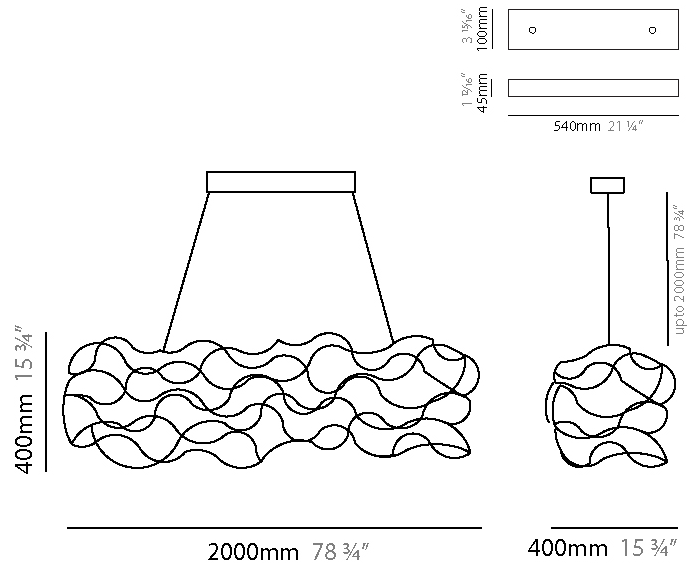

## SIRIO ABSTRACT SUSPENSION

D101683-

PROJECT	
TYPE	
SPECIFIER	
QUANTITY	
DATE	

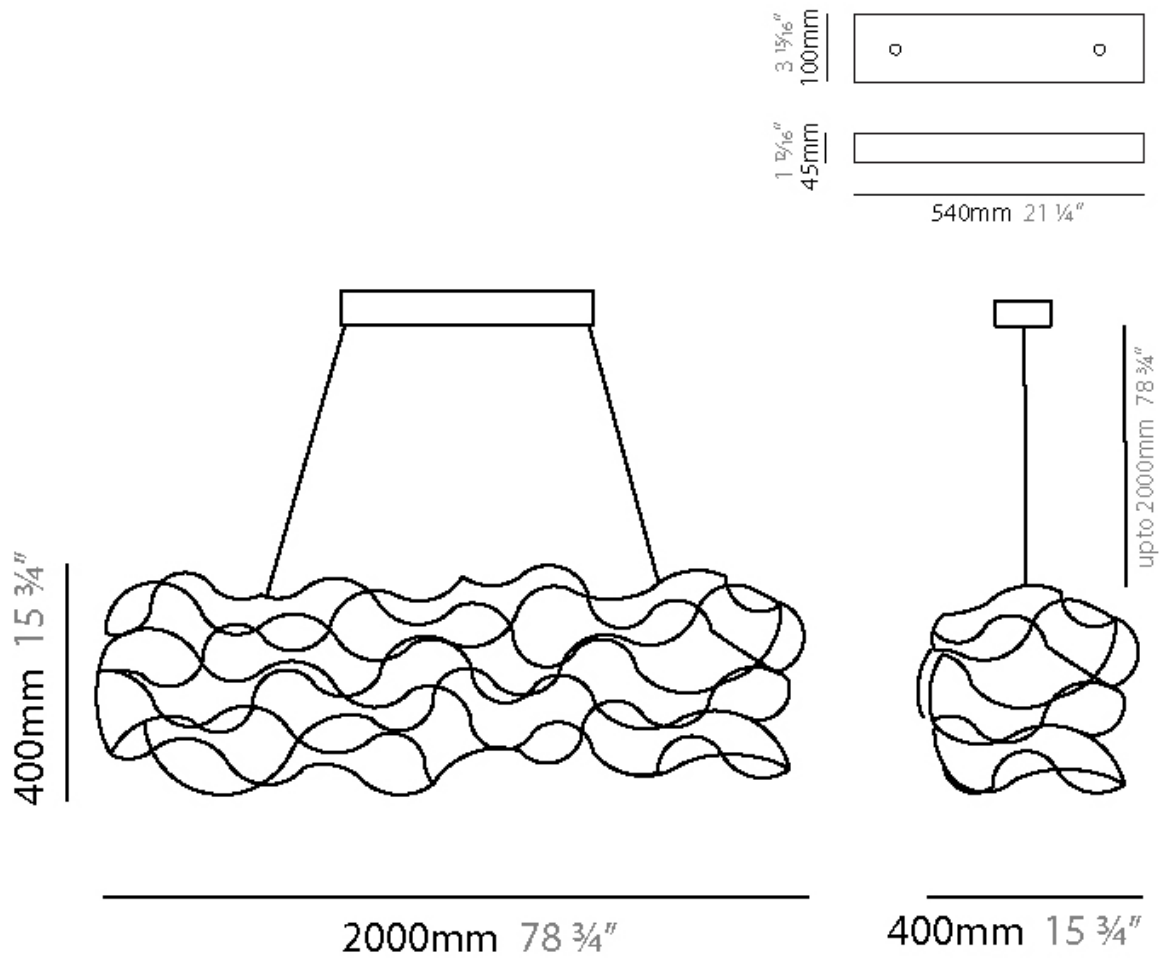

## SIRIO DISC SUSPENSION

### D101831-

base number    LED Dimming    Color Temperature    Finish Options

- To build a product code in our configurator select the specify button on the base model # product page
- To build a manual product code on this datasheet choose from the options listed below in blue font and add the suffix to the base model #

#### GENERAL

Series: Sirio  
 Subseries: Sirio Disc  
 Brand: Quasar  
 Division: Design  
 Mounting Type: Suspension  
 Mounting Location: Ceiling  
 Subcategory: Ambient

#### PHYSICAL

Shape: Abstract  
 Diameter (mm): 700  
 Diameter (in): 27 <sup>9</sup>/<sub>16</sub>"  
 Height (mm): 300  
 Height (in): 11 <sup>13</sup>/<sub>16</sub>"  
 Max. Overall Height (mm): 2300  
 Max. Overall Height (in): 90 <sup>9</sup>/<sub>16</sub>"  
 Light Distribution: Omnidirectional  
 Weight (kg): 3.5  
 Weight (lbs): 7.7  
[Fixture Finish: NIC / BRA / BBR](#)  
 Fixture Material: Metal  
 Cable Details: 2000mm Cable  
 Upon Request: Custom Sizes

#### ELECTRICAL

Lamp Type: LED  
 Input Wattage (W): 33  
 Max. Wattage Per Lamp (W): 3  
[Dimming: 0-10V Dimming / Phase Dimming \(120Vac Only\)](#)  
 Driver Included: Yes  
 Driver Location: Integrated  
 Driver Type: Constant Voltage - 120/277Vac  
 Driver Class: Class 2  
 Input Voltage (V): 120 - 277  
 Output Voltage (V): 12  
 Upon Request: (Not included - see components) Integral: 0-10Vdc dimming

#### LED

Number of LEDs: 50 + 1  
[Color Temperature \(°K\): 2400 / 2800](#)  
 Max. Delivered Lumen (lm): 2100 (2800K)  
 CRI: >90 CRI  
 Lamp Life (hrs): 50000

#### OPTICAL

#### RATINGS AND CERTIFICATIONS

Certified By: Certified for North American Standards  
 IP rating: IP20

PROJECT \_\_\_\_\_  
 TYPE \_\_\_\_\_  
 SPECIFIER \_\_\_\_\_  
 QUANTITY \_\_\_\_\_  
 DATE \_\_\_\_\_

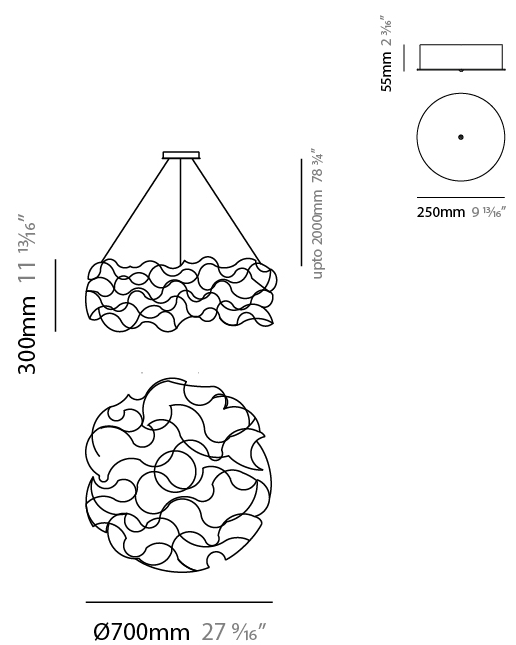

## SIRIO DISC SUSPENSION

D101831-

PROJECT

TYPE

SPECIFIER

QUANTITY

DATE

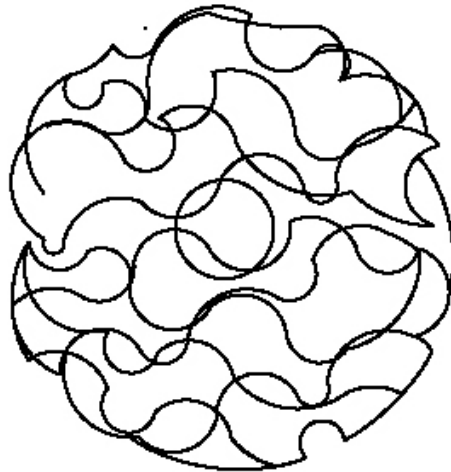
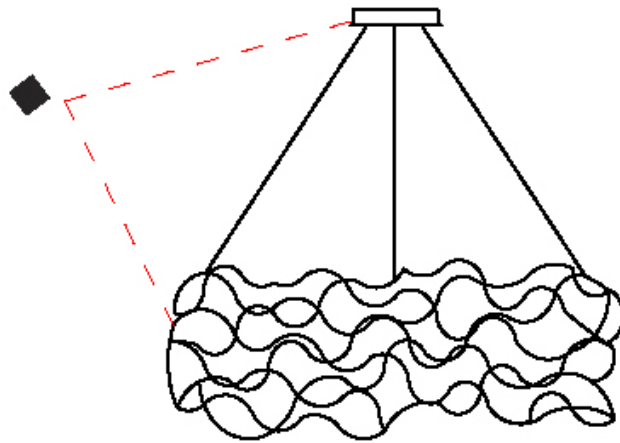

D

## SIRIO DISC SUSPENSION

### D101832-

base number    LED Dimming    Color Temperature    Finish Options

- To build a product code in our configurator select the specify button on the base model # product page
- To build a manual product code on this datasheet choose from the options listed below in blue font and add the suffix to the base model #

#### GENERAL

Series: Sirio  
 Subseries: Sirio Disc  
 Brand: Quasar  
 Division: Design  
 Mounting Type: Suspension  
 Mounting Location: Ceiling  
 Subcategory: Ambient

#### PHYSICAL

Shape: Abstract  
 Diameter (mm): 1300  
 Diameter (in): 51 <sup>3</sup>/<sub>16</sub>"  
 Height (mm): 400  
 Height (in): 15 <sup>3</sup>/<sub>4</sub>"  
 Max. Overall Height (mm): 2400  
 Max. Overall Height (in): 94 <sup>1</sup>/<sub>2</sub>"  
 Light Distribution: Omnidirectional  
 Weight (kg): 6.5  
 Weight (lbs): 14.3  
[Fixture Finish: NIC / BRA / BBR](#)  
 Fixture Material: Metal  
 Cable Details: 2000mm Cable  
 Upon Request: Custom Sizes

#### ELECTRICAL

Lamp Type: LED  
 Input Wattage (W): 81  
 Max. Wattage Per Lamp (W): 3  
[Dimming: Non-Dimming / Phase Dimming \(120vac Only\)](#)  
 Driver Included: Yes  
 Driver Location: Integrated  
 Driver Type: Constant Voltage - 120/277Vac  
 Driver Class: Class 2  
 Input Voltage (V): 120 - 277  
 Output Voltage (V): 12  
 Upon Request: (Not included - see components) Integral: 0-10Vdc dimming

#### LED

Number of LEDs: 130 + 1  
[Color Temperature \(°K\): 2400 / 2800](#)  
 Max. Delivered Lumen (lm): 3900 (2800K)  
 CRI: >90 CRI  
 Lamp Life (hrs): 50000

#### OPTICAL

#### RATINGS AND CERTIFICATIONS

Certified By: Certified for North American Standards  
 IP rating: IP20

PROJECT \_\_\_\_\_  
 TYPE \_\_\_\_\_  
 SPECIFIER \_\_\_\_\_  
 QUANTITY \_\_\_\_\_  
 DATE \_\_\_\_\_

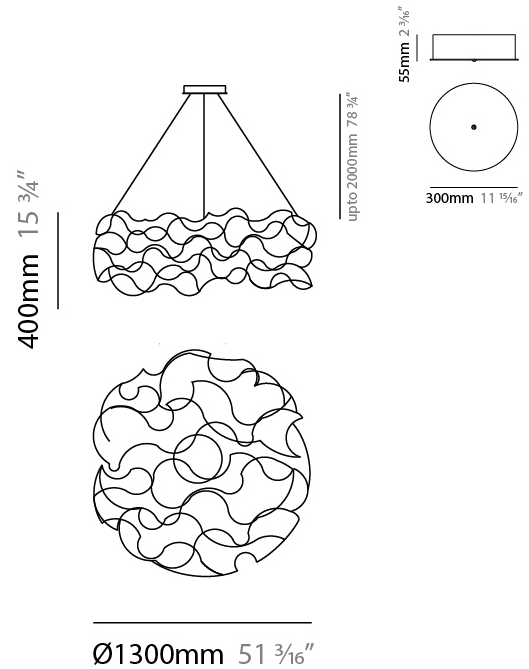

## SIRIO DISC SUSPENSION

D101832-

PROJECT

TYPE

SPECIFIER

QUANTITY

DATE

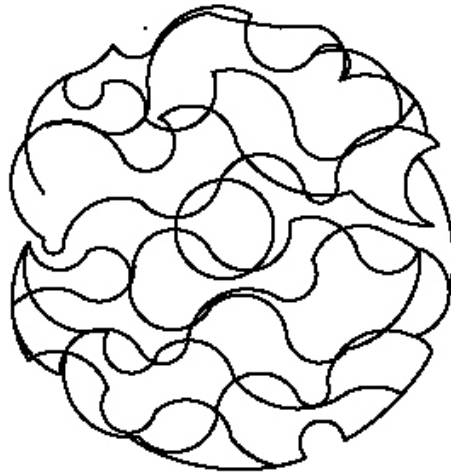
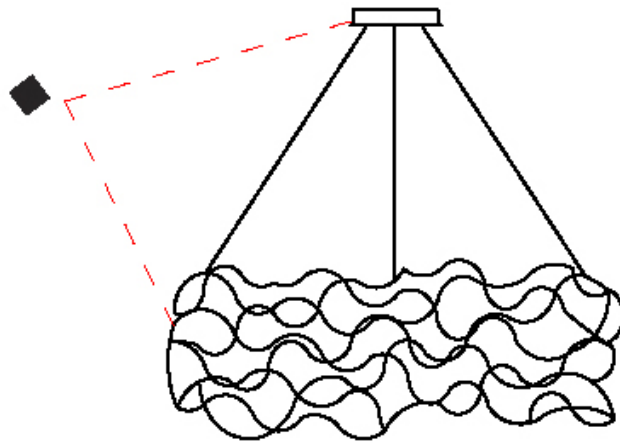

D



## SIRIO DISC SUSPENSION

### D101833-

base number    LED Dimming    Color Temperature    Finish Options

- To build a product code in our configurator select the specify button on the base model # product page
- To build a manual product code on this datasheet choose from the options listed below in blue font and add the suffix to the base model #

#### GENERAL

Series: Sirio  
 Subseries: Sirio Disc  
 Brand: Quasar  
 Division: Design  
 Mounting Type: Suspension  
 Mounting Location: Ceiling  
 Subcategory: Ambient

#### PHYSICAL

Shape: Abstract  
 Diameter (mm): 2000  
 Diameter (in): 78 3/4  
 Height (mm): 400  
 Height (in): 15 3/4  
 Max. Overall Height (mm): 2400  
 Max. Overall Height (in): 94 1/2  
 Light Distribution: Omnidirectional  
 Weight (kg): 6  
 Weight (lbs): 13.2  
 Fixture Finish: [NIC / BRA / BBR](#)  
 Fixture Material: Metal  
 Cable Details: 2000mm Cable  
 Upon Request: Custom Sizes

#### ELECTRICAL

Lamp Type: LED  
 Input Wattage (W): 123  
 Max. Wattage Per Lamp (W): 3  
 Dimming: [Non-Dimming / Phase Dimming \(120vac Only\)](#)  
 Driver Included: Yes  
 Driver Location: Integrated  
 Driver Type: Constant Voltage - 120/277Vac  
 Driver Class: Class 2  
 Input Voltage (V): 120 - 277  
 Output Voltage (V): 12  
 Upon Request: (Not included - see components) Integral: 0-10Vdc dimming

#### LED

Number of LEDs: 200 + 1  
 Color Temperature (°K): [2400 / 2800](#)  
 Max. Delivered Lumen (lm): 6000 (2800K)  
 CRI: >90 CRI  
 Lamp Life (hrs): 50000

#### OPTICAL

#### RATINGS AND CERTIFICATIONS

Certified By: Certified for North American Standards  
 IP rating: IP20

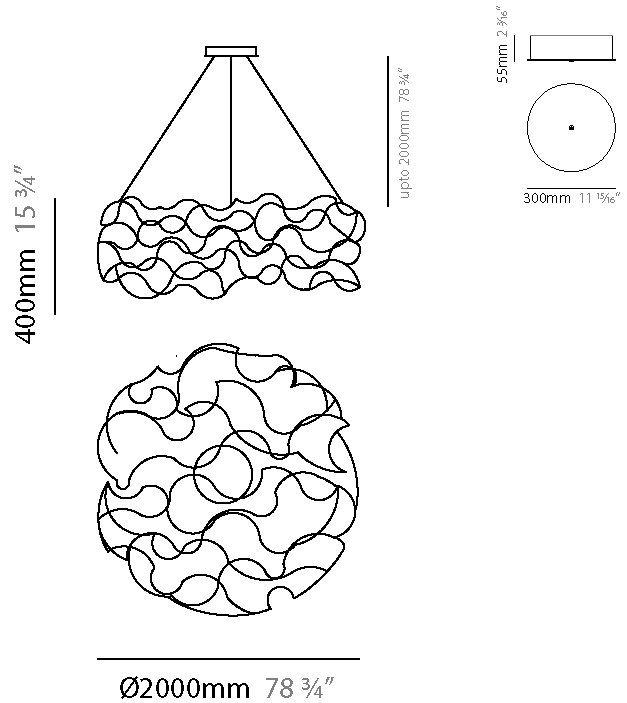

## SIRIO DISC SUSPENSION

D101833-

PROJECT

TYPE

SPECIFIER

QUANTITY

DATE

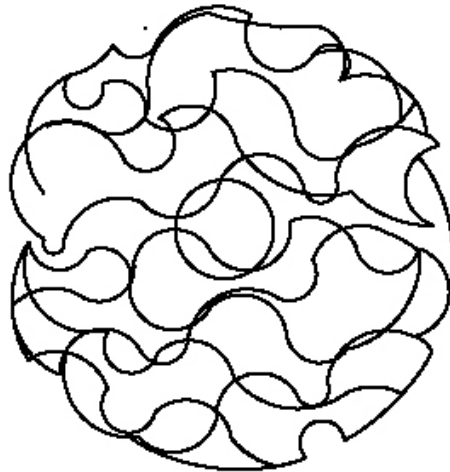
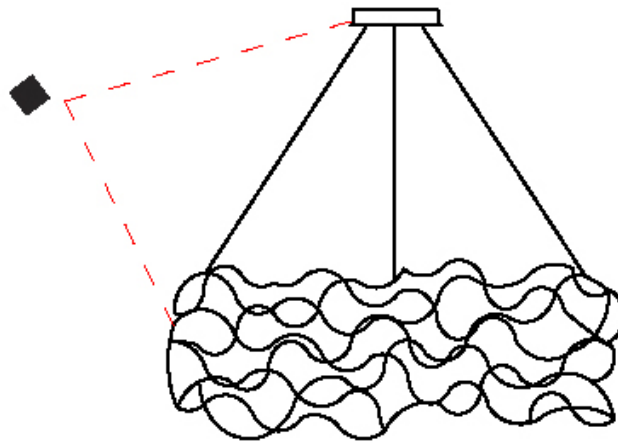

D

## SIRIO ABSTRACT SUSPENSION

### D101834-

base number    LED Dimming    Color Temperature    Finish Options

- To build a product code in our configurator select the specify button on the base model # product page
- To build a manual product code on this datasheet choose from the options listed below in blue font and add the suffix to the base model #

#### GENERAL

Series: Sirio  
 Subseries: Sirio Abstract  
 Brand: Quasar  
 Division: Design  
 Mounting Type: Suspension  
 Mounting Location: Ceiling  
 Subcategory: Ambient

#### PHYSICAL

Shape: Abstract  
 Length (mm): 1250  
 Length (in): 49 <sup>3</sup>/<sub>16</sub>"  
 Width (mm): 400  
 Width (in): 15 <sup>3</sup>/<sub>4</sub>"  
 Height (mm): 400  
 Height (in): 15 <sup>3</sup>/<sub>4</sub>"  
 Max. Overall Height (mm): 2400  
 Max. Overall Height (in): 94 <sup>1</sup>/<sub>2</sub>"  
 Light Distribution: Omnidirectional  
 Weight (kg): 4  
 Weight (lbs): 8.8  
[Fixture Finish: NIC / BRA / BBR](#)  
 Fixture Material: Metal  
 Cable Details: 2000mm Cable  
 Upon Request: Custom Sizes

#### ELECTRICAL

Lamp Type: LED  
 Input Wattage (W): 33  
 Max. Wattage Per Lamp (W): 3  
[Dimming: Non-Dimming / Phase Dimming \(120vac Only\)](#)  
 Driver Included: Yes  
 Driver Location: Integrated  
 Driver Type: Constant Voltage - 120/277Vac  
 Driver Class: Class 2  
 Input Voltage (V): 120 - 277  
 Output Voltage (V): 12  
 Upon Request: (Not included - see components) Integral: 0-10Vdc dimming

#### LED

Number of LEDs: 50 + 1  
[Color Temperature \(°K\): 2400 / 2800](#)  
 Max. Delivered Lumen (lm): 1500 (2800K)  
 CRI: >90 CRI  
 Lamp Life (hrs): 50000

#### OPTICAL

#### RATINGS AND CERTIFICATIONS

Certified By: Certified for North American Standards  
 IP rating: IP20

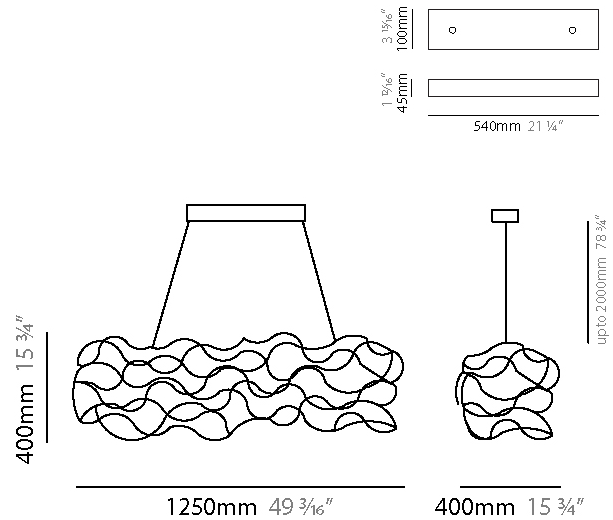

## SIRIO ABSTRACT SUSPENSION

D101834-

PROJECT	_____
TYPE	_____
SPECIFIER	_____
QUANTITY	_____
DATE	_____

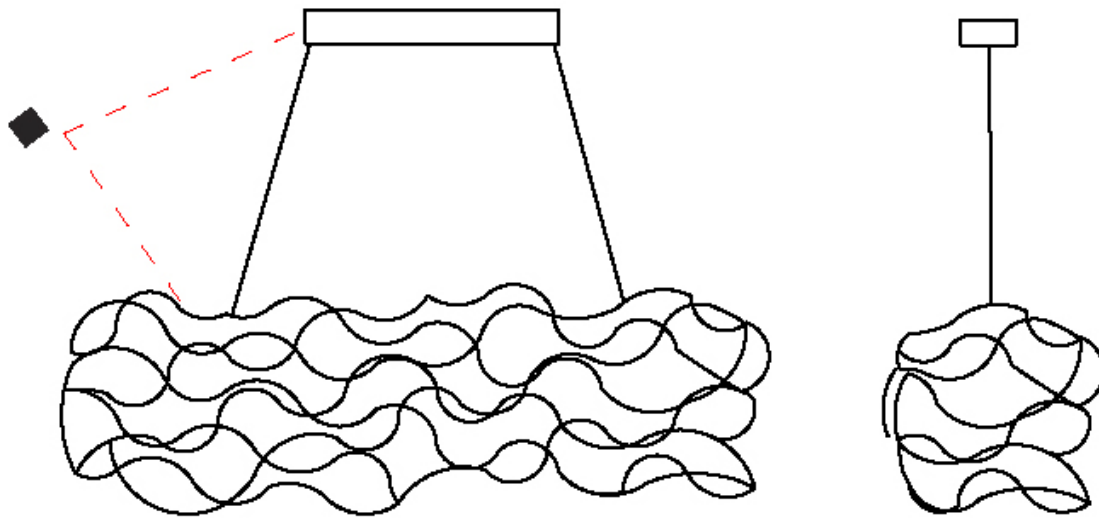

D

## SIRIO ABSTRACT SUSPENSION

### D101835-

base number    LED Dimming    Color Temperature    Finish Options

- To build a product code in our configurator select the specify button on the base model # product page
- To build a manual product code on this datasheet choose from the options listed below in blue font and add the suffix to the base model #

#### GENERAL

Series: Sirio  
 Subseries: Sirio Abstract  
 Brand: Quasar  
 Division: Design  
 Mounting Type: Suspension  
 Mounting Location: Ceiling  
 Subcategory: Ambient

#### PHYSICAL

Shape: Abstract  
 Length (mm): 1800  
 Length (in): 70 <sup>7</sup>/<sub>8</sub>  
 Width (mm): 400  
 Width (in): 15 <sup>3</sup>/<sub>4</sub>  
 Height (mm): 400  
 Height (in): 15 <sup>3</sup>/<sub>4</sub>  
 Max. Overall Height (mm): 2400  
 Max. Overall Height (in): 94 <sup>1</sup>/<sub>2</sub>  
 Light Distribution: Omnidirectional  
 Weight (kg): 4.5  
 Weight (lbs): 9.9  
[Fixture Finish: NIC / BRA / BBR](#)  
 Fixture Material: Metal  
 Cable Details: 2000mm Cable  
 Upon Request: Custom Sizes

#### ELECTRICAL

Lamp Type: LED  
 Input Wattage (W): 45  
 Max. Wattage Per Lamp (W): 3  
[Dimming: Non-Dimming / Phase Dimming \(120vac Only\)](#)  
 Driver Included: Yes  
 Driver Location: Integrated  
 Driver Type: Constant Voltage - 120/277Vac  
 Driver Class: Class 2  
 Input Voltage (V): 120 - 277  
 Output Voltage (V): 12  
 Upon Request: (Not included - see components) Integral: 0-10Vdc dimming

#### LED

Number of LEDs: 70 + 1  
[Color Temperature \(°K\): 2400 / 2800](#)  
 Max. Delivered Lumen (lm): 2100 (2800K)  
 CRI: >90 CRI  
 Lamp Life (hrs): 50000

#### OPTICAL

#### RATINGS AND CERTIFICATIONS

Certified By: Certified for North American Standards  
 IP rating: IP20

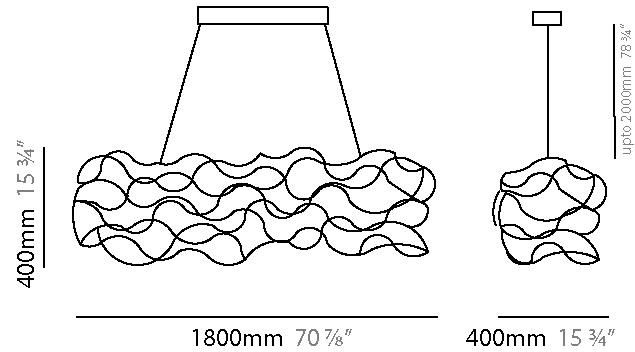
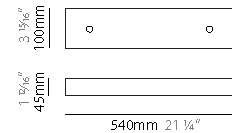

## SIRIO ABSTRACT SUSPENSION

D101835-

PROJECT \_\_\_\_\_

TYPE \_\_\_\_\_

SPECIFIER \_\_\_\_\_

QUANTITY \_\_\_\_\_

DATE \_\_\_\_\_

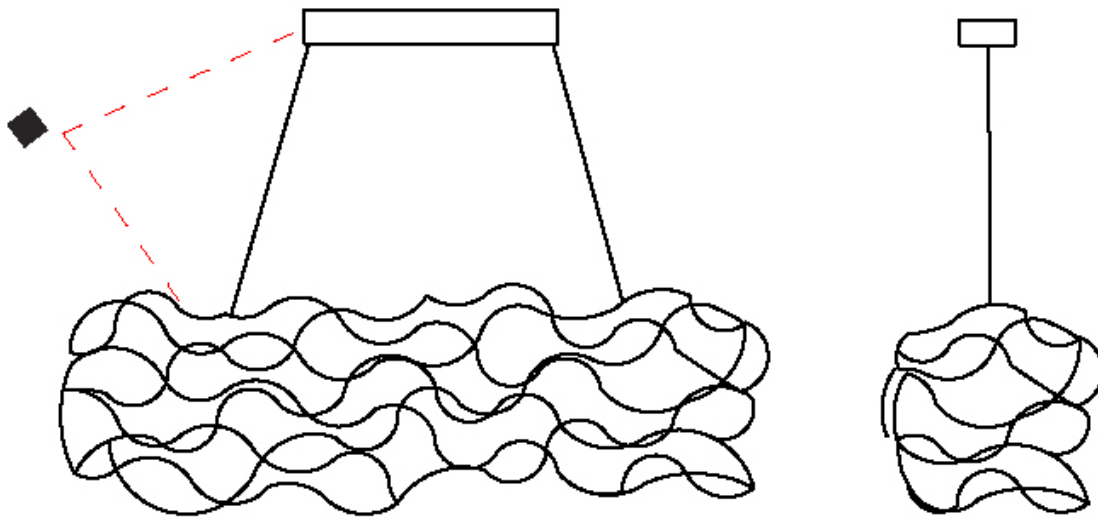

D

PROJECT	_____
TYPE	_____
SPECIFIER	_____
QUANTITY	_____
DATE	_____

## SIRIO ABSTRACT SUSPENSION

### D101836-

base number    LED Dimming    Color Temperature    Finish Options

- To build a product code in our configurator select the specify button on the base model # product page
- To build a manual product code on this datasheet choose from the options listed below in blue font and add the suffix to the base model #

#### GENERAL

Series: Sirio  
 Subseries: Sirio Abstract  
 Brand: Quasar  
 Division: Design  
 Mounting Type: Suspension  
 Mounting Location: Ceiling  
 Subcategory: Ambient

#### PHYSICAL

Shape: Abstract  
 Length (mm): 2000  
 Length (in): 78 ¾  
 Width (mm): 400  
 Width (in): 15 ¾  
 Height (mm): 400  
 Height (in): 15 ¾  
 Max. Overall Height (mm): 2400  
 Max. Overall Height (in): 94 ½  
 Light Distribution: Omnidirectional  
 Weight (kg): 4.5  
 Weight (lbs): 9.9  
[Fixture Finish: NIC / BRA / BBR](#)  
 Fixture Material: Metal  
 Cable Details: 2000mm Cable  
 Upon Request: Custom Sizes

#### ELECTRICAL

Lamp Type: LED  
 Input Wattage (W): 51  
 Max. Wattage Per Lamp (W): 3  
[Dimming: Non-Dimming / Phase Dimming \(120vac Only\)](#)  
 Driver Included: Yes  
 Driver Location: Integrated  
 Driver Type: Constant Voltage - 120/277Vac  
 Driver Class: Class 2  
 Input Voltage (V): 120 - 277  
 Output Voltage (V): 12  
 Upon Request: (Not included - see components) Integral: 0-10Vdc dimming

#### LED

Number of LEDs: 80 + 1  
[Color Temperature \(°K\): 2400 / 2800](#)  
 Max. Delivered Lumen (lm): 2400 (2800K)  
 CRI: >90 CRI  
 Lamp Life (hrs): 50000

#### OPTICAL

#### RATINGS AND CERTIFICATIONS

Certified By: Certified for North American Standards  
 IP rating: IP20

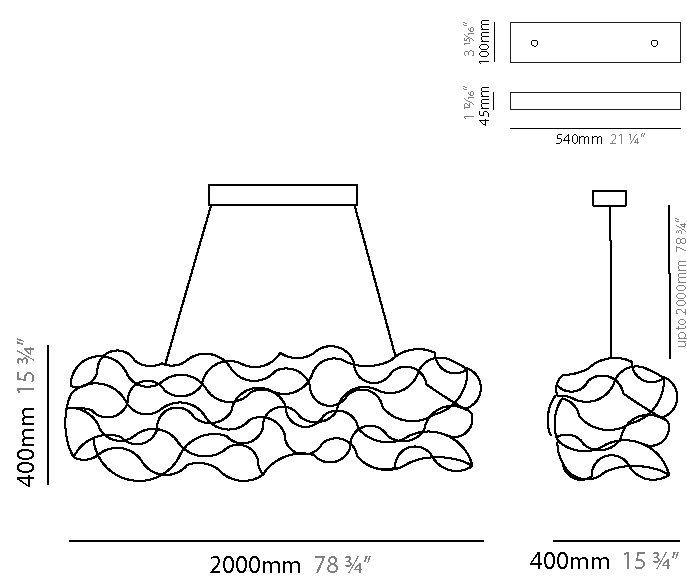

## SIRIO ABSTRACT SUSPENSION

D101836-

PROJECT \_\_\_\_\_

TYPE \_\_\_\_\_

SPECIFIER \_\_\_\_\_

QUANTITY \_\_\_\_\_

DATE \_\_\_\_\_

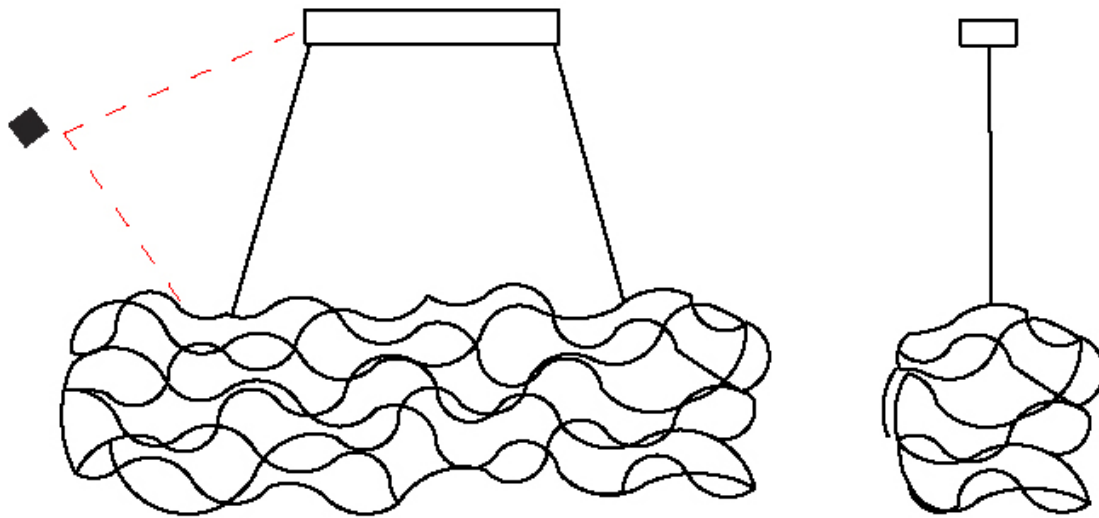

D



## SIRIO COLOR FINISH CHART

PROJECT	_____
TYPE	_____
SPECIFIER	_____
QUANTITY	_____
DATE	_____

### Fixture Finish

Nickel - NIC



Brass - BRA



Black Brass - BBR

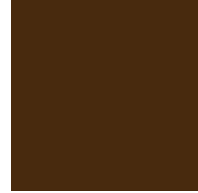

**Digital:** Not all screens are calibrated the same, and therefore, colors will appear differently between screens.

**Physical:** When texture is involved, there will be variations in color, character and tone within a product series and between product families.

Brass, nickel and copper are natural minerals and can potentially change color and show marks over time. We cannot guarantee the color appearance as the material transforms.



PROJECT	
TYPE	
SPECIFIER	
QUANTITY	
DATE	

### LEGEND

floor-mounted	pivotal	special LED (upon request) RGB, RGBW, tunable, gold+, meat+, art+, fashion+
wall and ceiling: recessed and surface mounted	rotating	warm dim / natural dimming LED
ceiling-mounted and wall-mounted	illuminate tilted	rechargeable battery powered
wall-mounted	color of suspension cable	fixture with natural vivid LED (upon request)
omni-directional light distribution	length of suspension cable	color rendering index
direct light distribution	reflector degree selection	color temperature
direct/indirect light distribution	super spot	lumen (luminous flux)
indirect light distribution	lens	efficacy (lumens per watt)
asymmetric light distribution	lens pack	Unified Glare Rating (UGR) range from 5-40
aura light distribution	shine ring	marine grade (AISI 316 stainless steel)
round wall or ceiling cut-out	integrated shine ring with diffuser	walk on
square wall or ceiling cut-out	free individual colors 01-29	drive on
the supplied jig specifies the cutout dimensions	individual colors: 00 (free of charge), 01-25 (extra charge)	Dark Sky Compliance
minimum distance (meters) lamp - object	luminaire part to be colored (F1)	Americans with Disabilities Act (less than 4" off the wall located between 27"-84" from floor)
recessed depth	luminaire part to be colored (F2)	lamp protected against explosion
ceiling thickness in mm	luminaire part to be colored (F3)	blown glass using traditional methods by master glass blower
ceiling thickness selection	luminaire part to be colored (F4)	acoustic material
dimmable DP (phase), DV (0-10V), DD (dali), DS (step-dim)	luminaire part to be colored (F5)	protection class I, protection insulation
included or excluded LED driver/transformer/control gear	color of 3-circuit adaptor	protection class II, protection insulation
separately switchable	indirect diffuser	ETL Certified to UL and CSA Standards
sensor	direct diffuser	UL Certified to UL and CSA Standards
remote control	ball-proof (upon request)	CSA Certified to UL and CSA Standards
available upon request	accessory	Certified for North American Standards

### IP RATING

IP20	protected against ingress of solid bodies greater than 12.5mm (finger)
IP33	protected against ingress of solid bodies greater than 2.5mm protected against sprays of water up to 60 degrees from the vertical (rain)
IP40	protected against ingress of solid bodies greater than 1mm (wire) no protection against the ingress of moisture
IP43	protected against ingress of solid bodies greater than 1mm (wire) protected against sprays of water up to 60 degrees from the vertical (rain)
IP44	protected against ingress of solid bodies greater than 1mm (wire) protected against water splashed from all directions
IP54	protected against limited ingress of dust (wet rooms/covered outdoor areas) protected against water splashed from all directions
IP65	protected against ingress of dust protected against jets of water
IP66	protected against ingress of dust protected against powerful jets of water or heavy seas
IP67	protected against ingress of dust protected against immersion of water between 15cm - 1m for 30 minutes
IP68	protected against ingress of dust protected against immersion of water under pressure for long periods

### IK RATING

IK01	protected against 0.14 joules impact (equivalent to 0.25kg mass dropped from 56mm above the surface)
IK02	protected against 0.2 joules impact (equivalent to 0.25kg mass dropped from 80mm above the surface)
IK03	protected against 0.35 joules impact (equivalent to 0.25kg mass dropped from 140mm above the surface)
IK04	protected against 0.5 joules impact (equivalent to 0.25kg mass dropped from 200mm above the surface)
IK05	protected against 0.7 joules impact (equivalent to 0.25kg mass dropped from 280mm above the surface)
IK06	protected against 1 joules impact (equivalent to 0.25kg mass dropped from 400mm above the surface)
IK07	protected against 2 joules impact (equivalent to 0.5kg mass dropped from 400mm above the surface)
IK08	protected against 5 joules impact (equivalent to 1.7kg mass dropped from 300mm above the surface)
IK09	protected against 10 joules impact (equivalent to 5.0kg mass dropped from 200mm above the surface)
IK10	protected against 20 joules impact (equivalent to 5.0kg mass dropped from 400mm above the surface)