

## SKYLINE SUSPENSION

### D61003-

base number            Finish             
Options           

PROJECT	_____
TYPE	_____
SPECIFIER	_____
QUANTITY	_____
DATE	_____

- To build a product code in our configurator select the specify button on the base model # product page
- To build a manual product code on this datasheet choose from the options listed below in blue font and add the suffix to the base model #

#### GENERAL

Series: Skyline \_\_\_\_\_  
 Partner: Linea Zero \_\_\_\_\_  
 Division: Design \_\_\_\_\_  
 Installation: Suspension \_\_\_\_\_  
 Product Type: Pendant \_\_\_\_\_  
 Mounting Location: Ceiling \_\_\_\_\_

#### PHYSICAL

Shape: Round \_\_\_\_\_  
 Diameter (mm): 400 \_\_\_\_\_  
 Diameter (in): 15 <sup>3</sup>/<sub>4</sub> \_\_\_\_\_  
 Height (mm): 300 \_\_\_\_\_  
 Height (in): 11 <sup>13</sup>/<sub>16</sub> \_\_\_\_\_  
 Max. Overall Height (mm): 1100 \_\_\_\_\_  
 Max. Overall Height (in): 43 <sup>5</sup>/<sub>16</sub> \_\_\_\_\_  
 Weight (kg): 1.98 \_\_\_\_\_  
 Weight (lbs): 4.37 \_\_\_\_\_  
 Diffuser: Polilux™ Shade - See Finish Options \_\_\_\_\_  
 Fixture Finish: WHI / BLK / SIL / NGD / COP / PKM \_\_\_\_\_  
 Fixture Material: Polilux™/ Metal holder \_\_\_\_\_  
 Primary Material: Non-Static Polilux \_\_\_\_\_

#### ELECTRICAL

Number of Lamps: 1 \_\_\_\_\_  
 Lamp Type: LED Retrofit \_\_\_\_\_  
 Bulb Included: Bulb Not Included \_\_\_\_\_  
 Max. Wattage Per Lamp (W): 7 \_\_\_\_\_  
 Lamp Base: E26 \_\_\_\_\_  
 Input Voltage (V): 120 \_\_\_\_\_  
 Upon Request: 277Vac / GU24 \_\_\_\_\_

#### LED

#### OPTICAL

#### RATINGS AND CERTIFICATIONS

Certified By: Certified for North American Standards \_\_\_\_\_  
 IP rating: IP20 \_\_\_\_\_

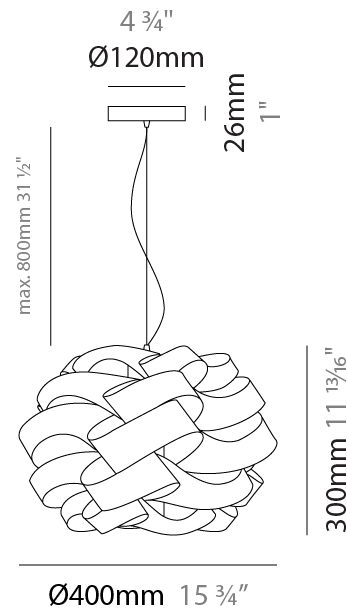

D61003-

PROJECT	_____
TYPE	_____
SPECIFIER	_____
QUANTITY	_____
DATE	_____

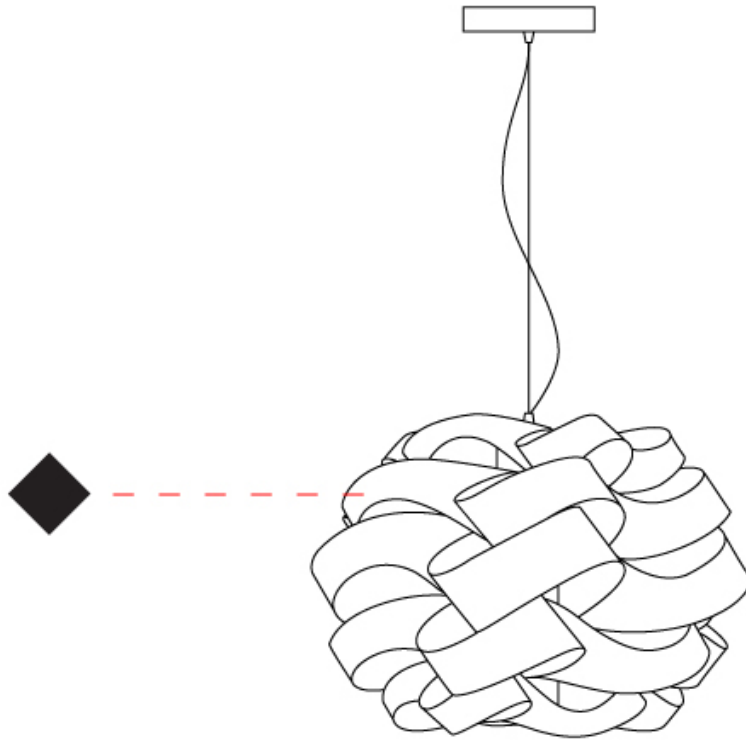

## SKYLINE SUSPENSION

### D61004-

base number            Finish             
Options           

PROJECT	_____
TYPE	_____
SPECIFIER	_____
QUANTITY	_____
DATE	_____

- To build a product code in our configurator select the specify button on the base model # product page
- To build a manual product code on this datasheet choose from the options listed below in blue font and add the suffix to the base model #

#### GENERAL

Series: Skyline \_\_\_\_\_  
 Partner: Linea Zero \_\_\_\_\_  
 Division: Design \_\_\_\_\_  
 Installation: Suspension \_\_\_\_\_  
 Product Type: Pendant \_\_\_\_\_  
 Mounting Location: Ceiling \_\_\_\_\_

#### PHYSICAL

Shape: Round \_\_\_\_\_  
 Diameter (mm): 500 \_\_\_\_\_  
 Diameter (in): 19 11/16 \_\_\_\_\_  
 Height (mm): 350 \_\_\_\_\_  
 Height (in): 13 3/4 \_\_\_\_\_  
 Max. Overall Height (mm): 1150 \_\_\_\_\_  
 Max. Overall Height (in): 45 1/4 \_\_\_\_\_  
 Diffuser: Polilux™ Shade - See Finish Options \_\_\_\_\_  
 Fixture Finish: WHI / BLK / SIL / NGD / COP / PKM \_\_\_\_\_  
 Fixture Material: Polilux™/ Metal holder \_\_\_\_\_  
 Primary Material: Non-Static Polilux \_\_\_\_\_  
 Cable Details: Cable length 31" - Transparent \_\_\_\_\_

#### ELECTRICAL

Number of Lamps: 1 \_\_\_\_\_  
 Lamp Type: LED Retrofit \_\_\_\_\_  
 Bulb Included: Bulb Not Included \_\_\_\_\_  
 Max. Wattage Per Lamp (W): 7 \_\_\_\_\_  
 Lamp Base: E26 \_\_\_\_\_  
 Input Voltage (V): 120 \_\_\_\_\_  
 Upon Request: 277Vac / GU24 \_\_\_\_\_

#### LED

#### OPTICAL

#### RATINGS AND CERTIFICATIONS

Certified By: Certified for North American Standards \_\_\_\_\_  
 IP rating: IP20 \_\_\_\_\_

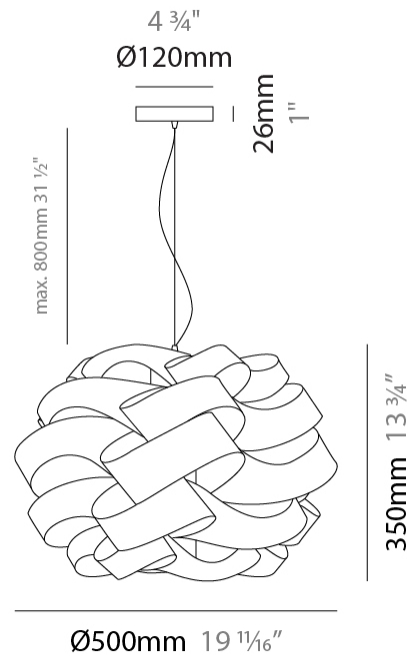

D61004-

PROJECT	_____
TYPE	_____
SPECIFIER	_____
QUANTITY	_____
DATE	_____

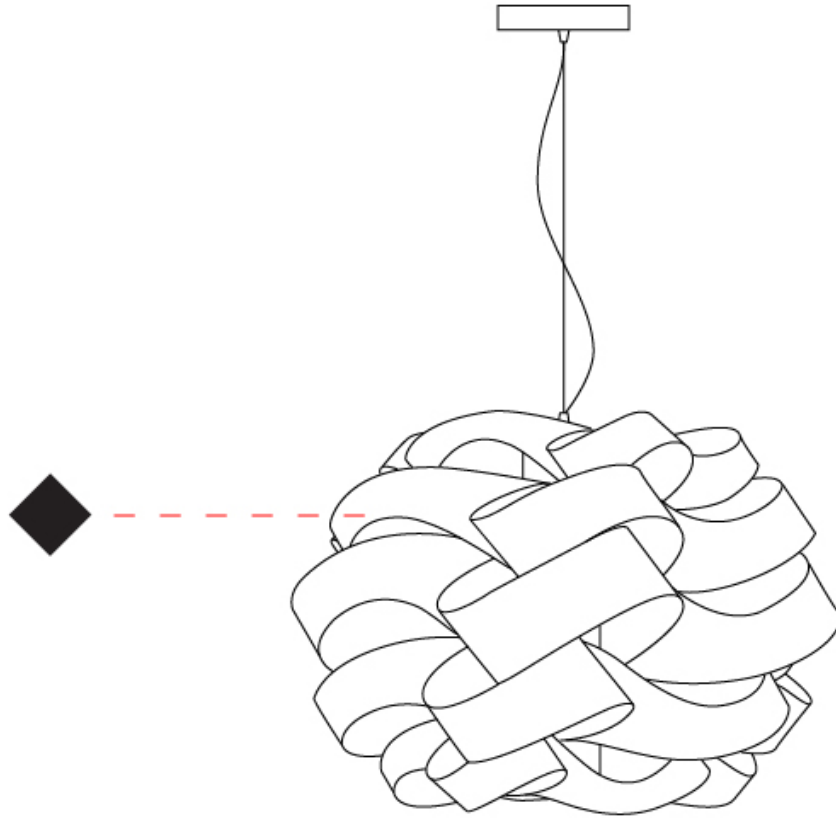

## SKYLINE SUSPENSION

### D61005-

base number            Finish             
Options           

PROJECT	_____
TYPE	_____
SPECIFIER	_____
QUANTITY	_____
DATE	_____

1. To build a product code in our configurator select the specify button on the base model # product page
2. To build a manual product code on this datasheet choose from the options listed below in blue font and add the suffix to the base model #

#### GENERAL

Series: Skyline \_\_\_\_\_  
 Partner: Linea Zero \_\_\_\_\_  
 Division: Design \_\_\_\_\_  
 Installation: Suspension \_\_\_\_\_  
 Product Type: Pendant \_\_\_\_\_  
 Mounting Location: Ceiling \_\_\_\_\_

#### PHYSICAL

Shape: Round \_\_\_\_\_  
 Diameter (mm): 600 \_\_\_\_\_  
 Diameter (in): 23 5/8 \_\_\_\_\_  
 Height (mm): 400 \_\_\_\_\_  
 Height (in): 15 3/4 \_\_\_\_\_  
 Max. Overall Height (mm): 1900 \_\_\_\_\_  
 Max. Overall Height (in): 74 13/16 \_\_\_\_\_  
 Diffuser: Polilux™ Shade - See Finish Options \_\_\_\_\_  
 Fixture Finish: WHI / BLK / SIL / NGD / COP / PKM \_\_\_\_\_  
 Fixture Material: Polilux™/ Metal holder \_\_\_\_\_  
 Primary Material: Non-Static Polilux \_\_\_\_\_

#### ELECTRICAL

Number of Lamps: 2 \_\_\_\_\_  
 Lamp Type: LED Retrofit \_\_\_\_\_  
 Bulb Included: Bulb Not Included \_\_\_\_\_  
 Max. Wattage Per Lamp (W): 7 \_\_\_\_\_  
 Lamp Base: E26 \_\_\_\_\_  
 Input Voltage (V): 120 \_\_\_\_\_  
 Upon Request: 277Vac / GU24 \_\_\_\_\_

#### LED

#### OPTICAL

#### RATINGS AND CERTIFICATIONS

Certified By: Certified for North American Standards \_\_\_\_\_  
 IP rating: IP20 \_\_\_\_\_

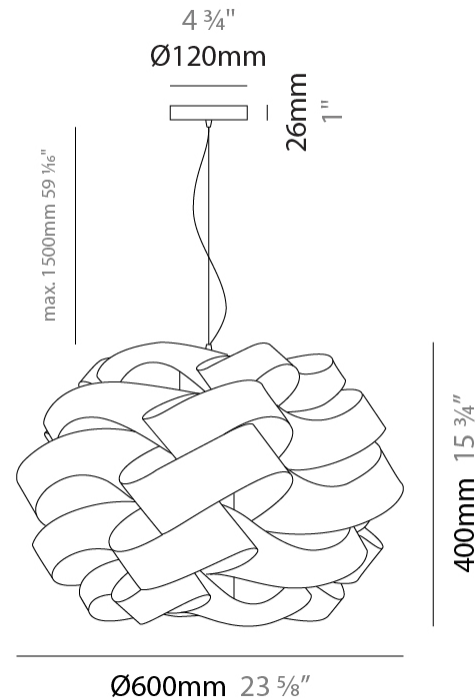

D61005-

PROJECT	_____
TYPE	_____
SPECIFIER	_____
QUANTITY	_____
DATE	_____

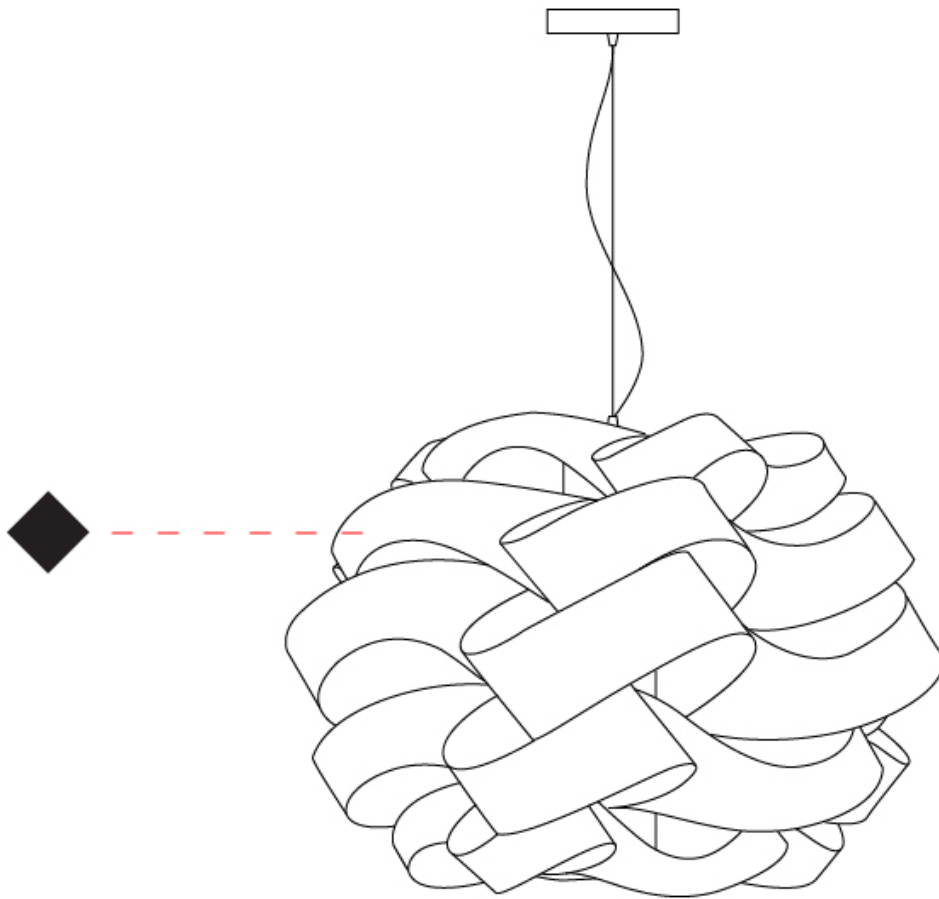

## SKYLINE SUSPENSION

### D61006-

base number            Finish             
Options           

PROJECT	_____
TYPE	_____
SPECIFIER	_____
QUANTITY	_____
DATE	_____

- To build a product code in our configurator select the specify button on the base model # product page
- To build a manual product code on this datasheet choose from the options listed below in blue font and add the suffix to the base model #

#### GENERAL

Series: Skyline \_\_\_\_\_  
 Partner: Linea Zero \_\_\_\_\_  
 Division: Design \_\_\_\_\_  
 Installation: Suspension \_\_\_\_\_  
 Product Type: Pendant \_\_\_\_\_  
 Mounting Location: Ceiling \_\_\_\_\_

#### PHYSICAL

Shape: Round \_\_\_\_\_  
 Diameter (mm): 750 \_\_\_\_\_  
 Diameter (in): 29 1/2 \_\_\_\_\_  
 Height (mm): 500 \_\_\_\_\_  
 Height (in): 19 11/16 \_\_\_\_\_  
 Max. Overall Height (mm): 2000 \_\_\_\_\_  
 Max. Overall Height (in): 78 3/4 \_\_\_\_\_  
 Diffuser: Polilux™ Shade - See Finish Options \_\_\_\_\_  
 Fixture Finish: WHI / BLK / SIL / NGD / COP / PKM \_\_\_\_\_  
 Fixture Material: Polilux™/ Metal holder \_\_\_\_\_  
 Primary Material: Non-Static Polilux \_\_\_\_\_

#### ELECTRICAL

Number of Lamps: 3 \_\_\_\_\_  
 Lamp Type: LED Retrofit \_\_\_\_\_  
 Bulb Included: Bulb Not Included \_\_\_\_\_  
 Max. Wattage Per Lamp (W): 7 \_\_\_\_\_  
 Lamp Base: E26 \_\_\_\_\_  
 Input Voltage (V): 120 \_\_\_\_\_  
 Upon Request: 277Vac / GU24 \_\_\_\_\_

#### LED

#### OPTICAL

#### RATINGS AND CERTIFICATIONS

Certified By: Certified for North American Standards \_\_\_\_\_  
 IP rating: IP20 \_\_\_\_\_

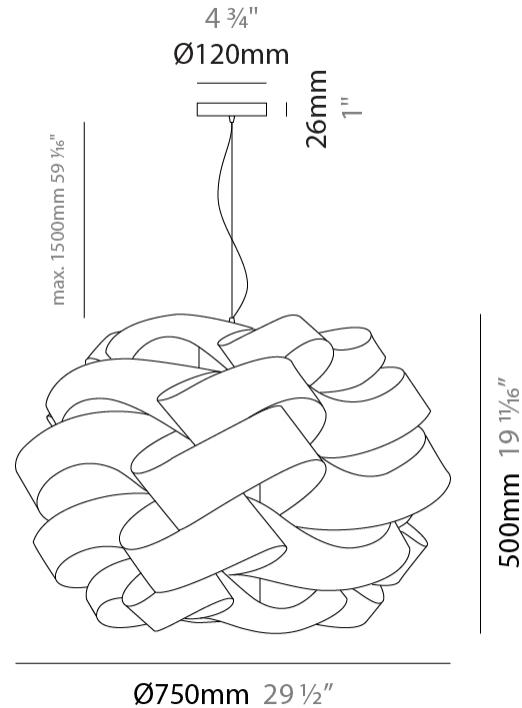

D61006-

PROJECT	_____
TYPE	_____
SPECIFIER	_____
QUANTITY	_____
DATE	_____

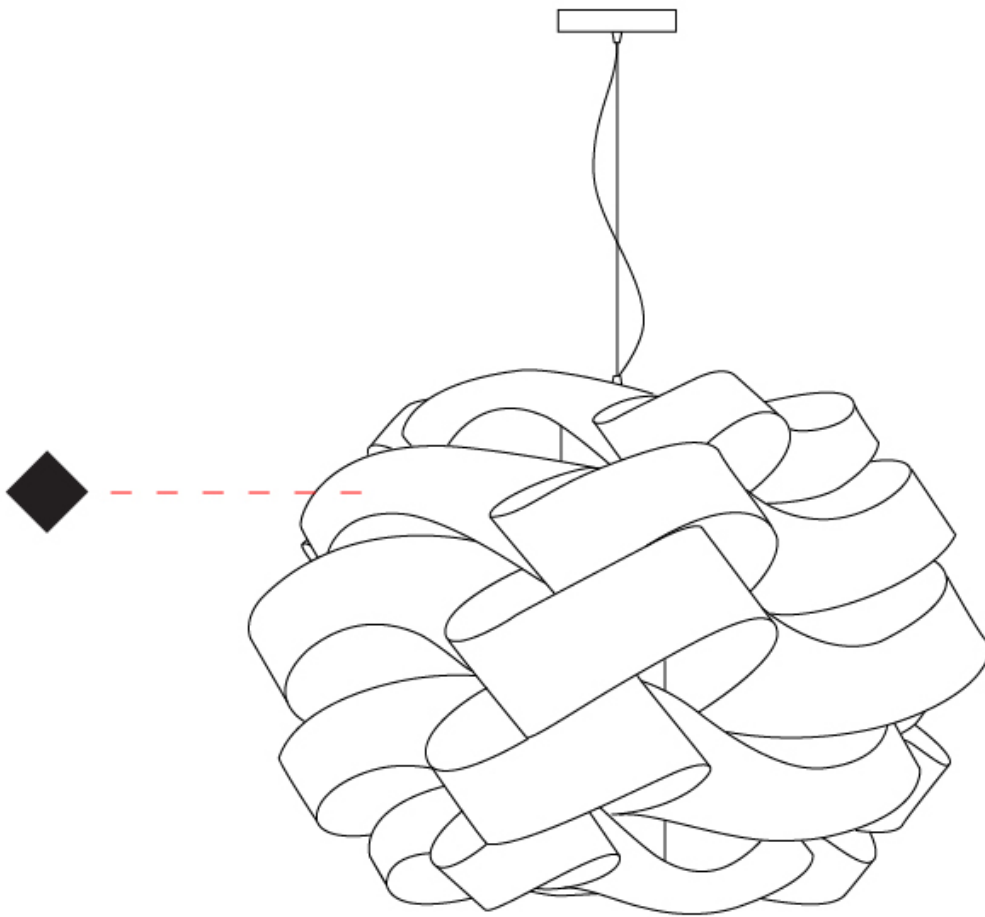

D

## SKYLINE SUSPENSION

### D61007-

base number            Finish             
Options           

PROJECT	_____
TYPE	_____
SPECIFIER	_____
QUANTITY	_____
DATE	_____

1. To build a product code in our configurator select the specify button on the base model # product page
2. To build a manual product code on this datasheet choose from the options listed below in blue font and add the suffix to the base model #

#### GENERAL

Series: Skyline \_\_\_\_\_  
 Partner: Linea Zero \_\_\_\_\_  
 Division: Design \_\_\_\_\_  
 Installation: Suspension \_\_\_\_\_  
 Product Type: Pendant \_\_\_\_\_  
 Mounting Location: Ceiling \_\_\_\_\_

#### PHYSICAL

Shape: Round \_\_\_\_\_  
 Diameter (mm): 1000 \_\_\_\_\_  
 Diameter (in): 39 3/8 \_\_\_\_\_  
 Height (mm): 700 \_\_\_\_\_  
 Height (in): 27 9/16 \_\_\_\_\_  
 Max. Overall Height (mm): 2200 \_\_\_\_\_  
 Max. Overall Height (in): 86 5/8 \_\_\_\_\_  
 Diffuser: Polilux™ Shade - See Finish Options \_\_\_\_\_  
 Fixture Finish: [WHI](#) / [BLK](#) / [SIL](#) / [NGD](#) / [COP](#) / [PKM](#) \_\_\_\_\_  
 Fixture Material: Polilux™/ Metal holder \_\_\_\_\_  
 Primary Material: Non-Static Polilux \_\_\_\_\_

#### ELECTRICAL

Number of Lamps: 5 \_\_\_\_\_  
 Lamp Type: LED Retrofit \_\_\_\_\_  
 Bulb Included: Bulb Not Included \_\_\_\_\_  
 Max. Wattage Per Lamp (W): 7 \_\_\_\_\_  
 Lamp Base: E26 \_\_\_\_\_  
 Input Voltage (V): 120 \_\_\_\_\_  
 Upon Request: 277Vac / GU24 \_\_\_\_\_

#### LED

#### OPTICAL

#### RATINGS AND CERTIFICATIONS

Certified By: Certified for North American Standards \_\_\_\_\_  
 IP rating: IP20 \_\_\_\_\_

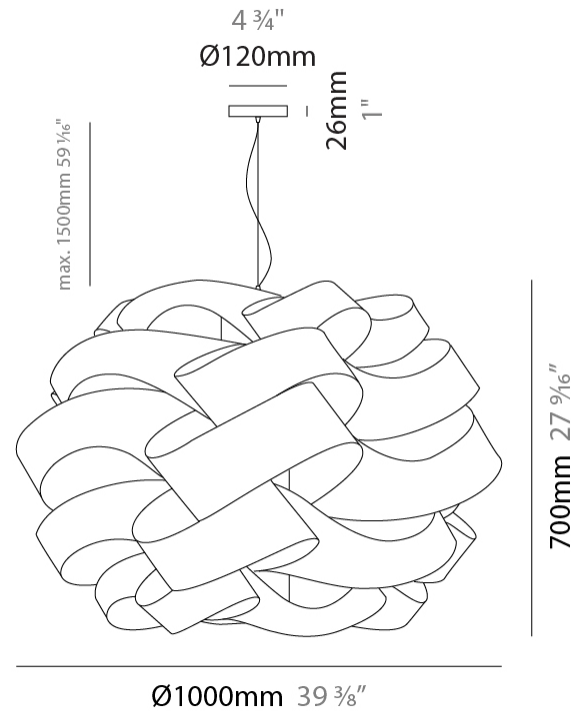

D61007-

PROJECT

TYPE

SPECIFIER

QUANTITY

DATE

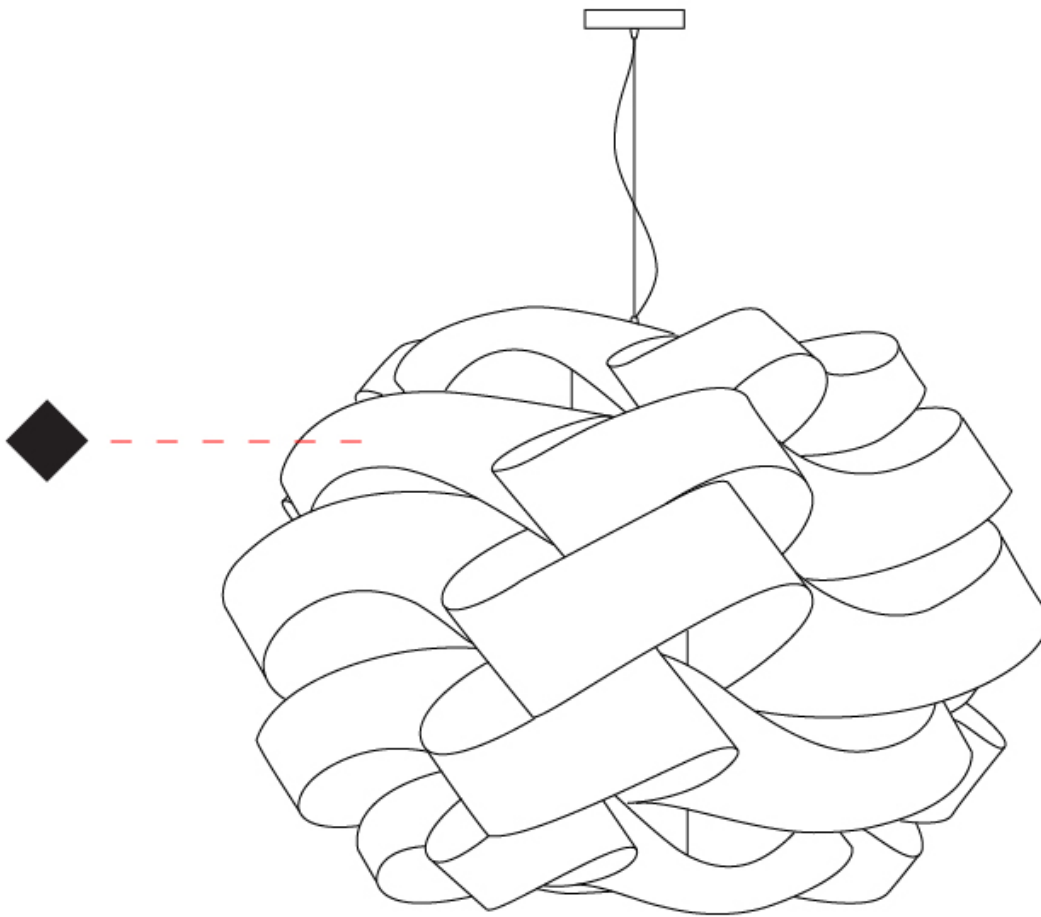

D



## SKYLINE SURFACE

D62000-

PROJECT	_____
TYPE	_____
SPECIFIER	_____
QUANTITY	_____
DATE	_____

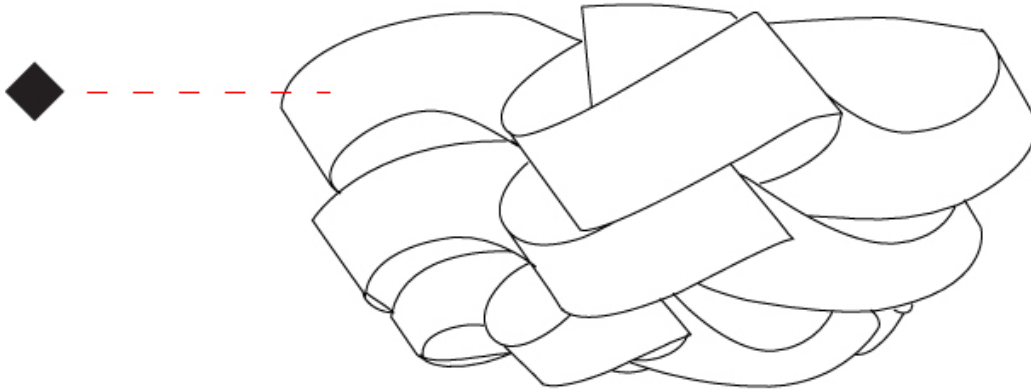

## SKYLINE SURFACE

### D62000- : D62000-WHI

base number

1. To build a product code in our configurator select the specify button on the base model # product page
2. To build a manual product code on this datasheet choose from the options listed below in blue font and add the suffix to the base model #

#### GENERAL

Series: Skyline  
Partner: Linea Zero  
Division: Design  
Installation: Surface  
Product Type: Ceiling Surface  
Mounting Location: Ceiling

#### PHYSICAL

Shape: Round  
Diameter (mm): 400  
Diameter (in): 15 3/4  
Height (mm): 190  
Height (in): 7 1/2  
Weight (kg): 1.3  
Weight (lbs): 2.799  
Diffuser: White Polilux<sup>a</sup> Shade  
Fixture Material: Polilux™/ Metal holder  
Primary Material: Non-Static Polilux

#### ELECTRICAL

Number of Lamps: 1  
Lamp Type: LED Retrofit  
Bulb Included: Bulb Not Included  
Total Output Wattage (W): 7  
Max. Wattage Per Lamp (W): 7  
Lamp Base: E26  
Input Voltage (V): 120

#### LED

#### OPTICAL

#### RATINGS AND CERTIFICATIONS

Certified By: CSA Certified to UL and CSA Standards  
IP rating: IP20

PROJECT	_____
TYPE	_____
SPECIFIER	_____
QUANTITY	_____
DATE	_____

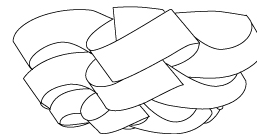

Ø400mm 15 3/4"



## SKYLINE SURFACE

D62000- : D62000-WHI

PROJECT	_____
TYPE	_____
SPECIFIER	_____
QUANTITY	_____
DATE	_____

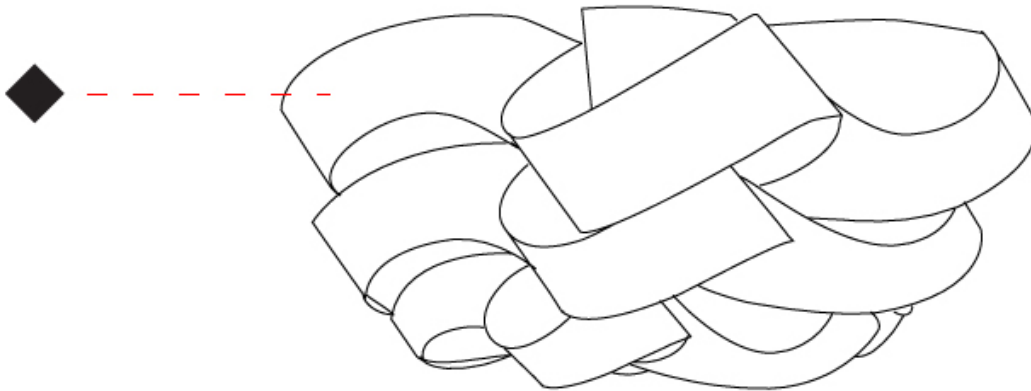

PROJECT
TYPE
SPECIFIER
QUANTITY
DATE

## SKYLINE SURFACE

### D62001-

base number            Finish             
Options           

- To build a product code in our configurator select the specify button on the base model # product page
- To build a manual product code on this datasheet choose from the options listed below in blue font and add the suffix to the base model #

#### GENERAL

Series: Skyline             
 Partner: Linea Zero             
 Division: Design             
 Installation: Surface             
 Product Type: Ceiling Surface             
 Mounting Location: Ceiling           

#### PHYSICAL

Shape: Round             
 Diameter (mm): 500             
 Diameter (in): 19 11/16             
 Height (mm): 240             
 Height (in): 9 7/16             
 Diffuser: Polilux™ Shade - See Finish Options             
 Fixture Finish: WHI / BLK / SIL / NGD / COP / PKM             
 Fixture Material: Polilux™/ Metal holder             
 Primary Material: Non-Static Polilux           

#### ELECTRICAL

Number of Lamps: 1             
 Lamp Type: LED Retrofit             
 Bulb Included: Bulb Not Included             
 Max. Wattage Per Lamp (W): 7             
 Lamp Base: E26             
 Input Voltage (V): 120             
 Upon Request: 277Vac / GU24           

#### LED

#### OPTICAL

#### RATINGS AND CERTIFICATIONS

Certified By: Certified for North American Standards             
 IP rating: IP20           

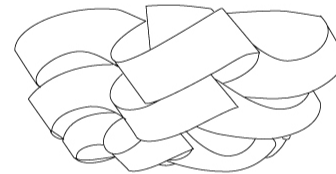

Ø500mm 19 11/16"



## SKYLINE SURFACE

D62001-

PROJECT

TYPE

SPECIFIER

QUANTITY

DATE

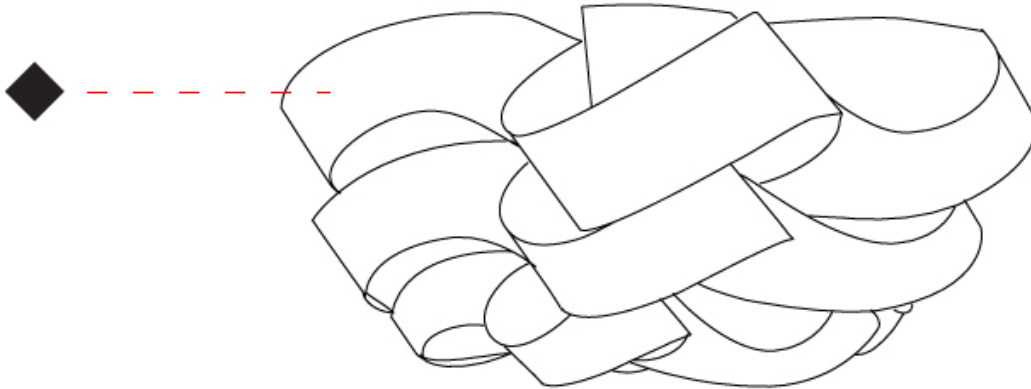

D

PROJECT	_____
TYPE	_____
SPECIFIER	_____
QUANTITY	_____
DATE	_____

## SKYLINE SURFACE

### D62002-

base number      Finish  
Options

1. To build a product code in our configurator select the specify button on the base model # product page
2. To build a manual product code on this datasheet choose from the options listed below in blue font and add the suffix to the base model #

#### GENERAL

Series: Skyline  
Partner: Linea Zero  
Division: Design  
Installation: Surface  
Product Type: Ceiling Surface  
Mounting Location: Ceiling

#### PHYSICAL

Shape: Round  
Diameter (mm): 600  
Diameter (in): 23 5/8  
Height (mm): 280  
Height (in): 11  
Diffuser: Polilux™ Shade - See Finish Options  
Fixture Finish: WHI / BLK / SIL / NGD / COP / PKM  
Fixture Material: Polilux™/ Metal holder  
Primary Material: Non-Static Polilux

#### ELECTRICAL

Number of Lamps: 1  
Lamp Type: LED Retrofit  
Bulb Included: Bulb Not Included  
Max. Wattage Per Lamp (W): 7  
Lamp Base: E26  
Input Voltage (V): 120  
Upon Request: 277Vac / GU24

#### LED

#### OPTICAL

#### RATINGS AND CERTIFICATIONS

Certified By: Certified for North American Standards  
IP rating: IP20

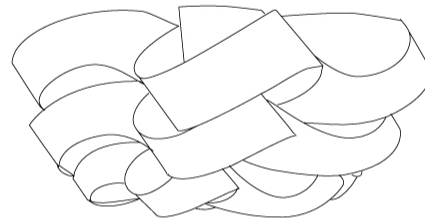

Ø600mm 23 5/8"



## SKYLINE SURFACE

D62002-

PROJECT

TYPE

SPECIFIER

QUANTITY

DATE

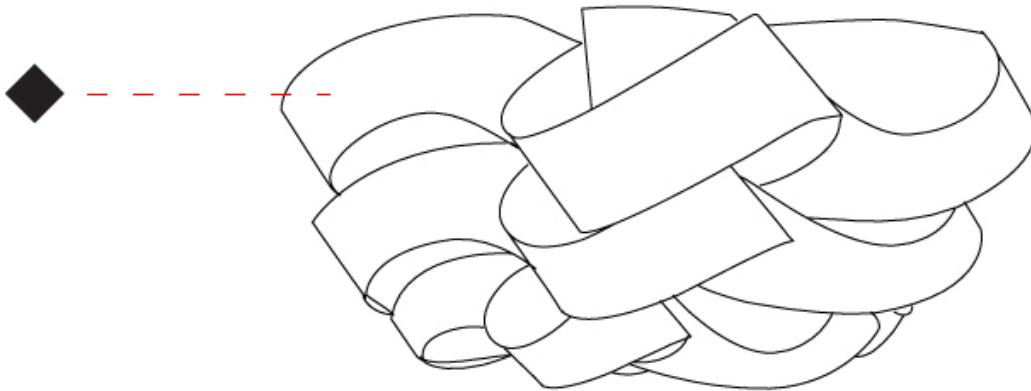

D

PROJECT
TYPE
SPECIFIER
QUANTITY
DATE

## SKYLINE SURFACE

### D62003-

base number Finish  
Options

- To build a product code in our configurator select the specify button on the base model # product page
- To build a manual product code on this datasheet choose from the options listed below in blue font and add the suffix to the base model #

#### GENERAL

Series: Skyline  
 Partner: Linea Zero  
 Division: Design  
 Installation: Surface  
 Product Type: Ceiling Surface  
 Mounting Location: Ceiling

#### PHYSICAL

Shape: Round  
 Diameter (mm): 750  
 Diameter (in): 29 1/2  
 Height (mm): 360  
 Height (in): 14 3/16  
 Diffuser: Polilux™ Shade - See Finish Options  
 Fixture Finish: WHI / BLK / SIL / NGD / COP / PKM  
 Fixture Material: Polilux™/ Metal holder  
 Primary Material: Non-Static Polilux

#### ELECTRICAL

Number of Lamps: 2  
 Lamp Type: LED Retrofit  
 Bulb Included: Bulb Not Included  
 Max. Wattage Per Lamp (W): 7  
 Lamp Base: E26  
 Input Voltage (V): 120  
 Upon Request: 277Vac / GU24

#### LED

#### OPTICAL

#### RATINGS AND CERTIFICATIONS

Certified By: Certified for North American Standards  
 IP rating: IP20

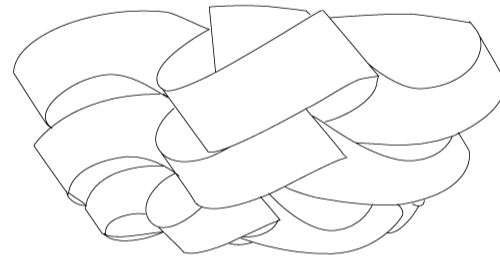

Ø750mm 29 1/2"



## SKYLINE SURFACE

D62003-

PROJECT

TYPE

SPECIFIER

QUANTITY

DATE

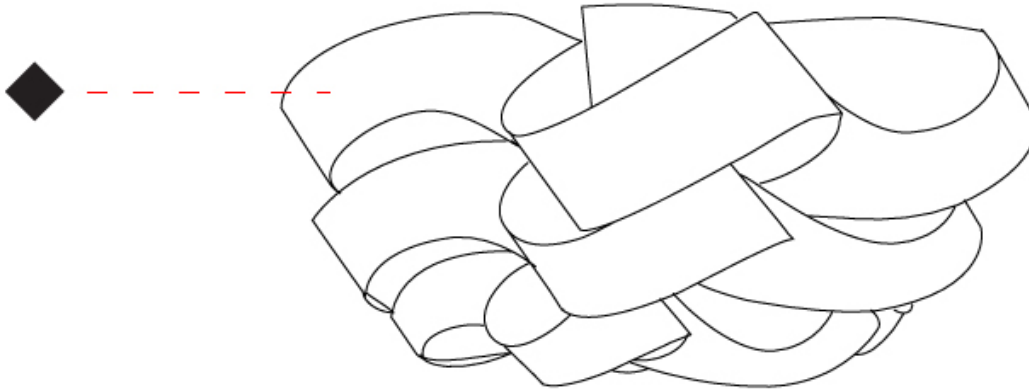

D

PROJECT
TYPE
SPECIFIER
QUANTITY
DATE

## SKYLINE SURFACE

### D62004-

base number      Finish  
Options

- To build a product code in our configurator select the specify button on the base model # product page
- To build a manual product code on this datasheet choose from the options listed below in blue font and add the suffix to the base model #

#### GENERAL

Series: Skyline  
 Partner: Linea Zero  
 Division: Design  
 Installation: Surface  
 Product Type: Ceiling Surface  
 Mounting Location: Ceiling

#### PHYSICAL

Shape: Round  
 Diameter (mm): 1000  
 Diameter (in): 39 3/8  
 Height (mm): 480  
 Height (in): 18 7/8  
 Diffuser: Polilux™ Shade - See Finish Options  
 Fixture Finish: WHI / BLK / SIL / NGD / COP / PKM  
 Fixture Material: Polilux™/ Metal holder  
 Primary Material: Non-Static Polilux

#### ELECTRICAL

Number of Lamps: 5  
 Lamp Type: LED Retrofit  
 Bulb Included: Bulb Not Included  
 Max. Wattage Per Lamp (W): 7  
 Lamp Base: E26  
 Input Voltage (V): 120  
 Upon Request: 277Vac / GU24

#### LED

#### OPTICAL

#### RATINGS AND CERTIFICATIONS

Certified By: Certified for North American Standards  
 IP rating: IP20

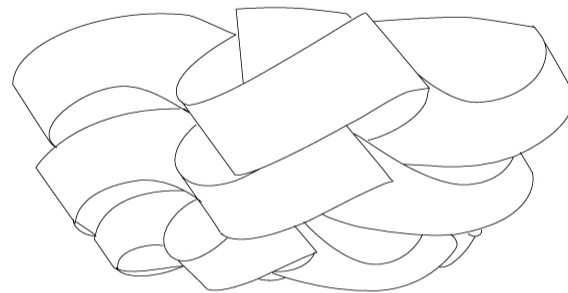

Ø1000mm 39 3/8"



## SKYLINE SURFACE

D62004-

PROJECT

TYPE

SPECIFIER

QUANTITY

DATE

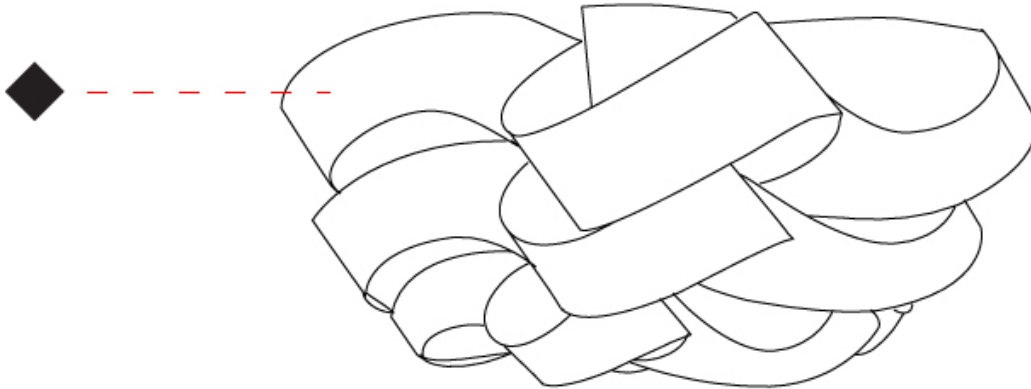

D

## SKYLINE PORTABLE

### D64000-

base number            Finish             
Options           

- To build a product code in our configurator select the specify button on the base model # product page
- To build a manual product code on this datasheet choose from the options listed below in blue font and add the suffix to the base model #

#### GENERAL

Series: Skyline             
Partner: Linea Zero             
Division: Design             
Installation: Portable             
Product Type: Floor             
Mounting Location: Floor           

#### PHYSICAL

Shape: Round             
Diameter (mm): 500             
Diameter (in): 19 11/16             
Height (mm): 1700             
Height (in): 66 15/16             
Diffuser: Polilux™ Shade - See Finish Options             
Fixture Finish: WHI / BLK / SIL / NGD / COP / PKM             
Fixture Material: Polilux™/ Metal holder             
Primary Material: Non-Static Polilux             
Upon Request: Bolt Down           

#### ELECTRICAL

Number of Lamps: 1             
Lamp Type: LED Retrofit             
Bulb Included: Bulb Not Included             
Max. Wattage Per Lamp (W): 7             
Lamp Base: E26             
Input Voltage (V): 120             
Upon Request: 277Vac / GU24           

#### LED

#### OPTICAL

#### RATINGS AND CERTIFICATIONS

Certified By: Certified for North American Standards             
IP rating: IP20           

PROJECT	_____
TYPE	_____
SPECIFIER	_____
QUANTITY	_____
DATE	_____

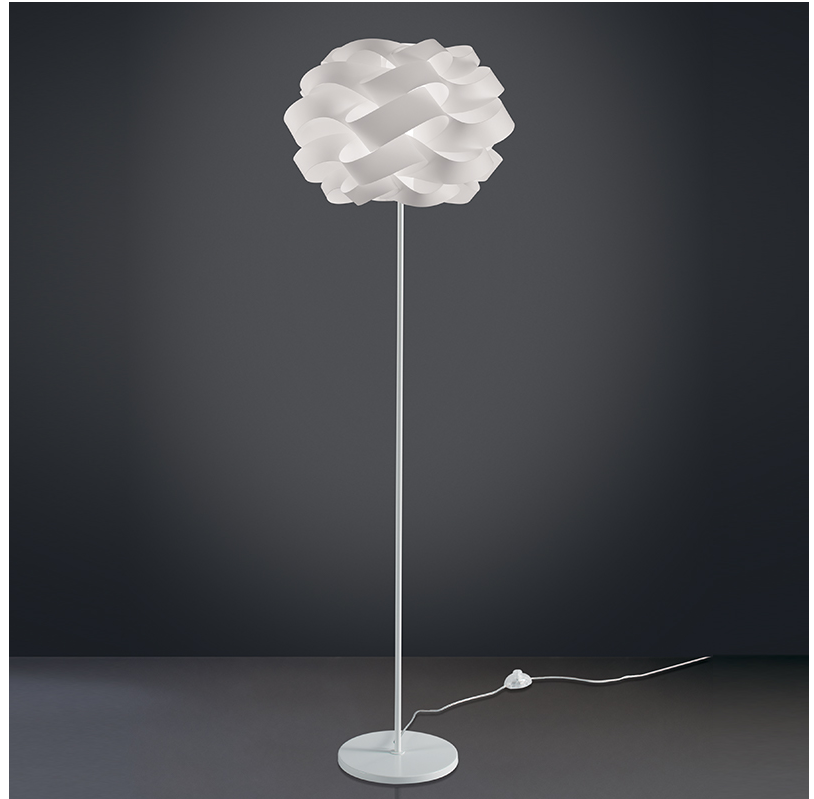

## SKYLINE PORTABLE

D64000-

PROJECT

TYPE

SPECIFIER

QUANTITY

DATE

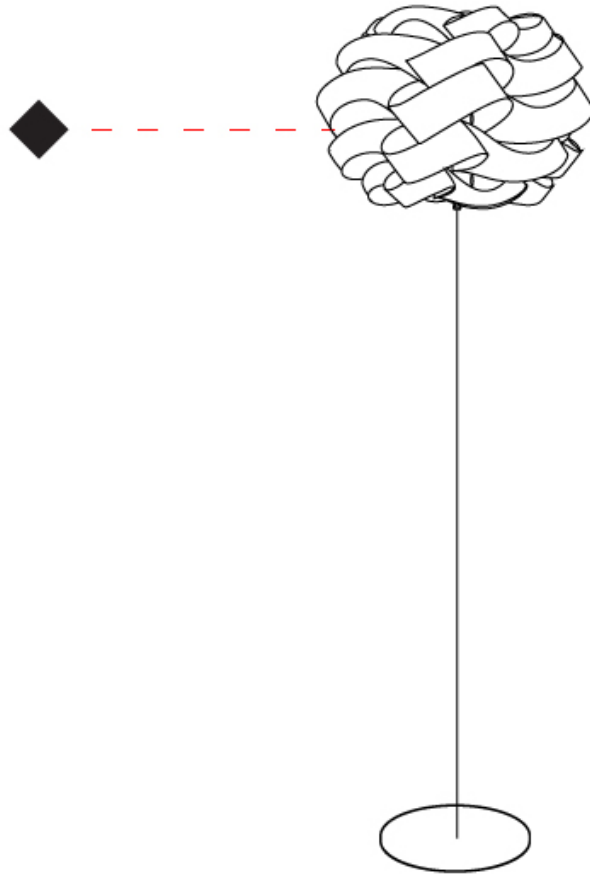

D

## SKYLINE PORTABLE

### D64001-

base number            Finish             
Options           

- To build a product code in our configurator select the specify button on the base model # product page
- To build a manual product code on this datasheet choose from the options listed below in blue font and add the suffix to the base model #

#### GENERAL

Series: Skyline             
 Partner: Linea Zero             
 Division: Design             
 Installation: Portable             
 Product Type: Floor             
 Mounting Location: Floor           

#### PHYSICAL

Shape: Round             
 Diameter (mm): 500             
 Diameter (in): 19 11/16             
 Height (mm): 1700             
 Height (in): 66 15/16             
 Diffuser: Polilux™ Shade - See Finish Options             
 Fixture Finish: WHI / BLK / SIL / NGD / COP / PKM             
 Fixture Material: Polilux™/ Metal holder             
 Primary Material: Non-Static Polilux           

#### ELECTRICAL

Number of Lamps: 1             
 Lamp Type: LED Retrofit             
 Bulb Included: Bulb Not Included             
 Max. Wattage Per Lamp (W): 7             
 Lamp Base: E26             
 Input Voltage (V): 120             
 Upon Request: 277Vac / GU24           

#### LED

#### OPTICAL

#### RATINGS AND CERTIFICATIONS

Certified By: Certified for North American Standards             
 IP rating: IP20           

PROJECT	_____
TYPE	_____
SPECIFIER	_____
QUANTITY	_____
DATE	_____

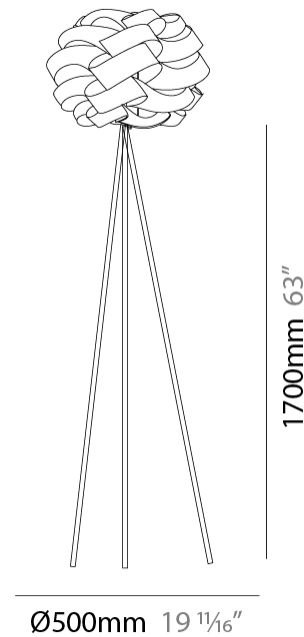

D64001-

PROJECT

TYPE

SPECIFIER

QUANTITY

DATE

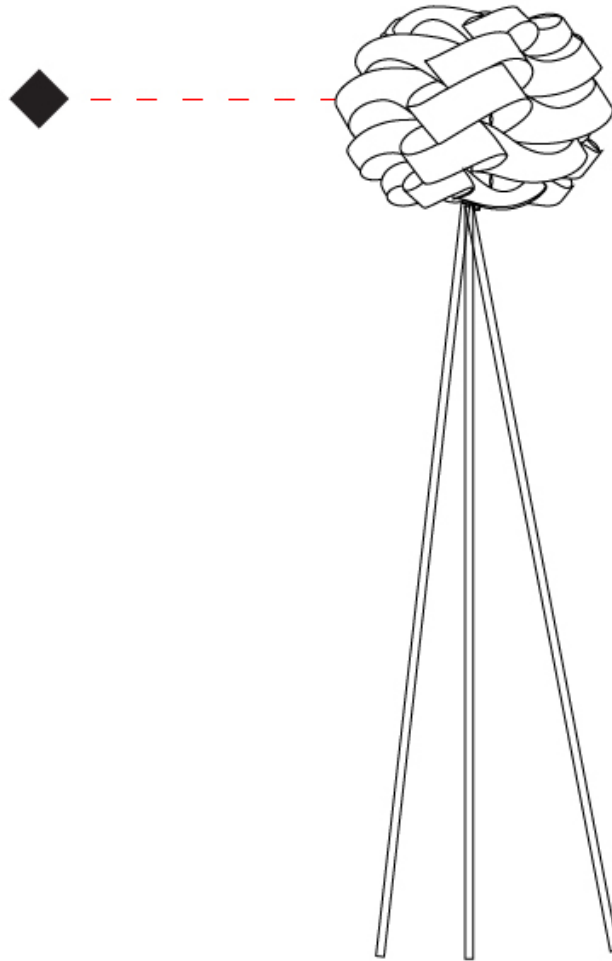

D

## SKYLINE PORTABLE

### D64047-

base number            Finish             
Options           

PROJECT	_____
TYPE	_____
SPECIFIER	_____
QUANTITY	_____
DATE	_____

1. To build a product code in our configurator select the specify button on the base model # product page
2. To build a manual product code on this datasheet choose from the options listed below in blue font and add the suffix to the base model #

#### GENERAL

Series: Skyline \_\_\_\_\_  
 Partner: Linea Zero \_\_\_\_\_  
 Division: Design \_\_\_\_\_  
 Installation: Portable \_\_\_\_\_  
 Product Type: Table \_\_\_\_\_  
 Mounting Location: Table \_\_\_\_\_

#### PHYSICAL

Shape: Round \_\_\_\_\_  
 Diameter (mm): 400 \_\_\_\_\_  
 Diameter (in): 15 3/4 \_\_\_\_\_  
 Height (mm): 630 \_\_\_\_\_  
 Height (in): 24 13/16 \_\_\_\_\_  
 Diffuser: Polilux™ Shade - See Finish Options \_\_\_\_\_  
 Fixture Finish: WHI / BLK / SIL / NGD / COP / PKM \_\_\_\_\_  
 Fixture Material: Polilux™/ Metal holder \_\_\_\_\_  
 Primary Material: Non-Static Polilux \_\_\_\_\_

#### ELECTRICAL

Number of Lamps: 1 \_\_\_\_\_  
 Lamp Type: LED Retrofit \_\_\_\_\_  
 Bulb Included: Bulb Not Included \_\_\_\_\_  
 Max. Wattage Per Lamp (W): 7 \_\_\_\_\_  
 Lamp Base: E26 \_\_\_\_\_  
 Input Voltage (V): 120 \_\_\_\_\_  
 Upon Request: 277Vac / GU24 \_\_\_\_\_

#### LED

#### OPTICAL

#### RATINGS AND CERTIFICATIONS

Certified By: Certified for North American Standards \_\_\_\_\_  
 IP rating: IP20 \_\_\_\_\_

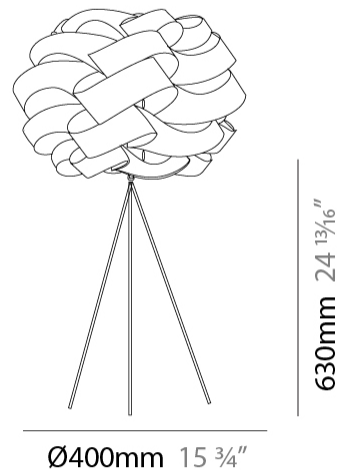

D64047-

PROJECT

TYPE

SPECIFIER

QUANTITY

DATE

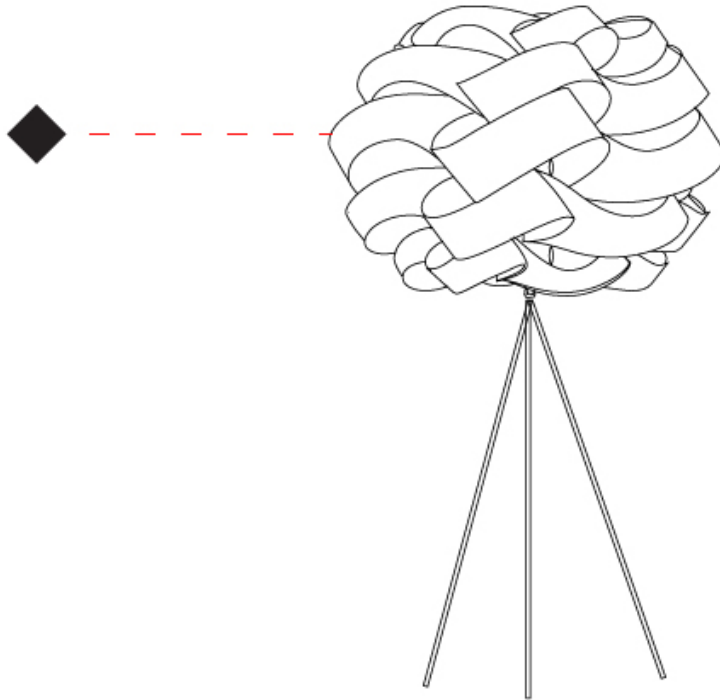

D

PROJECT	_____
TYPE	_____
SPECIFIER	_____
QUANTITY	_____
DATE	_____

### Fixture Finish

White - WHI



Black - BLK

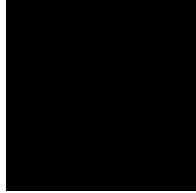

Silver - SIL



New Gold - NGD



Copper - COP



Pink Metal - PKM



**Digital:** Not all screens are calibrated the same, and therefore, colors will appear differently between screens.

**Physical:** When texture is involved, there will be variations in color, character and tone within a product series and between product families.



### LEGEND

	floor-mounted		pivotal		special LED (upon request) RGB, RGBW, tunable, gold+, meat+, art+, fashion+
	wall and ceiling: recessed and surface mounted		rotating		warm dim / natural dimming LED
	ceiling-mounted and wall-mounted		illuminate tilted		rechargeable battery powered
	wall-mounted		color of suspension cable		fixture with natural vivid LED (upon request)
	omni-directional light distribution		length of suspension cable		color rendering index
	direct light distribution		reflector degree selection		color temperature
	direct/indirect light distribution		super spot		lumen (luminous flux)
	indirect light distribution		lens		efficacy (lumens per watt)
	asymmetric light distribution		lens pack		Unified Glare Rating (UGR) range from 5-40
	aura light distribution		shine ring		marine grade (AISI 316 stainless steel)
	round wall or ceiling cut-out		integrated shine ring with diffuser		walk on
	square wall or ceiling cut-out		free individual colors 01-29		drive on
	the supplied jig specifies the cutout dimensions		individual colors: 00 (free of charge), 01-25 (extra charge)		Dark Sky Compliance
	minimum distance (meters) lamp - object		luminaire part to be colored (F1)		Americans with Disabilities Act (less than 4" off the wall located between 27"-84" from floor)
	recessed depth		luminaire part to be colored (F2)		lamp protected against explosion
	ceiling thickness in mm		luminaire part to be colored (F3)		blown glass using traditional methods by master glass blower
	ceiling thickness selection		luminaire part to be colored (F4)		acoustic material
	dimnable DP (phase), DV (0-10V), DD (dali), DS (step-dim)		luminaire part to be colored (F5)		protection class I, protection insulation
	included or excluded LED driver/transformer/control gear		color of 3-circuit adaptor		protection class II, protection insulation
	separately switchable		indirect diffuser		ETL Certified to UL and CSA Standards
	sensor		direct diffuser		UL Certified to UL and CSA Standards
	remote control		ball-proof (upon request)		CSA Certified to UL and CSA Standards
	available upon request		accessory		Certified for North American Standards

### IP RATING

	protected against ingress of solid bodies greater than 12.5mm (finger)
	protected against ingress of solid bodies greater than 2.5mm protected against sprays of water up to 60 degrees from the vertical (rain)
	protected against ingress of solid bodies greater than 1mm (wire) no protection against the ingress of moisture
	protected against ingress of solid bodies greater than 1mm (wire) protected against sprays of water up to 60 degrees from the vertical (rain)
	protected against ingress of solid bodies greater than 1mm (wire) protected against water splashed from all directions
	protected against limited ingress of dust (wet rooms/covered outdoor areas) protected against water splashed from all directions
	protected against ingress of dust protected against jets of water
	protected against ingress of dust protected against powerful jets of water or heavy seas
	protected against ingress of dust protected against immersion of water between 15cm - 1m for 30 minutes
	protected against ingress of dust protected against immersion of water under pressure for long periods

### IK RATING

	protected against 0.14 joules impact (equivalent to 0.25kg mass dropped from 56mm above the surface)
	protected against 0.2 joules impact (equivalent to 0.25kg mass dropped from 80mm above the surface)
	protected against 0.35 joules impact (equivalent to 0.25kg mass dropped from 140mm above the surface)
	protected against 0.5 joules impact (equivalent to 0.25kg mass dropped from 200mm above the surface)
	protected against 0.7 joules impact (equivalent to 0.25kg mass dropped from 280mm above the surface)
	protected against 1 joules impact (equivalent to 0.25kg mass dropped from 400mm above the surface)
	protected against 2 joules impact (equivalent to 0.5kg mass dropped from 400mm above the surface)
	protected against 5 joules impact (equivalent to 1.7kg mass dropped from 300mm above the surface)
	protected against 10 joules impact (equivalent to 5.0kg mass dropped from 200mm above the surface)
	protected against 20 joules impact (equivalent to 5.0kg mass dropped from 400mm above the surface)