

SKYLINE SUSPENSION

D61003-

base number Finish
Options

PROJECT	_____
TYPE	_____
SPECIFIER	_____
QUANTITY	_____
DATE	_____

- To build a product code in our configurator select the specify button on the base model # product page
- To build a manual product code on this datasheet choose from the options listed below in blue font and add the suffix to the base model #

GENERAL

Series: Skyline _____
 Partner: Linea Zero _____
 Division: Design _____
 Installation: Suspension _____
 Product Type: Pendant _____
 Mounting Location: Ceiling _____

PHYSICAL

Shape: Round _____
 Diameter (mm): 400 _____
 Diameter (in): 15 ³/₄ _____
 Height (mm): 300 _____
 Height (in): 11 ¹³/₁₆ _____
 Max. Overall Height (mm): 1100 _____
 Max. Overall Height (in): 43 ⁵/₁₆ _____
 Weight (kg): 1.98 _____
 Weight (lbs): 4.37 _____
 Diffuser: Polilux™ Shade - See Finish Options _____
 Fixture Finish: WHI / BLK / SIL / NGD / COP / PKM _____
 Fixture Material: Polilux™/ Metal holder _____
 Primary Material: Non-Static Polilux _____

ELECTRICAL

Number of Lamps: 1 _____
 Lamp Type: LED Retrofit _____
 Bulb Included: Bulb Not Included _____
 Max. Wattage Per Lamp (W): 7 _____
 Lamp Base: E26 _____
 Input Voltage (V): 120 _____
 Upon Request: 277Vac / GU24 _____

LED

OPTICAL

RATINGS AND CERTIFICATIONS

Certified By: Certified for North American Standards _____
 IP rating: IP20 _____

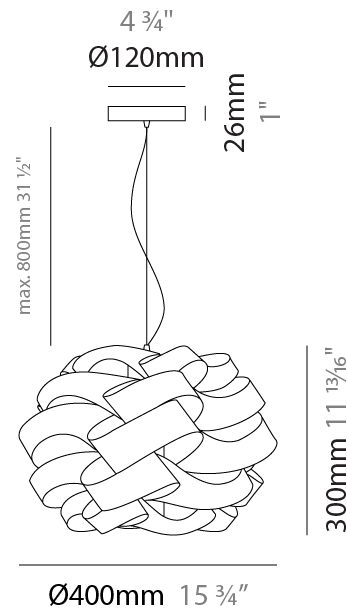

D61003-

PROJECT

TYPE

SPECIFIER

QUANTITY

DATE

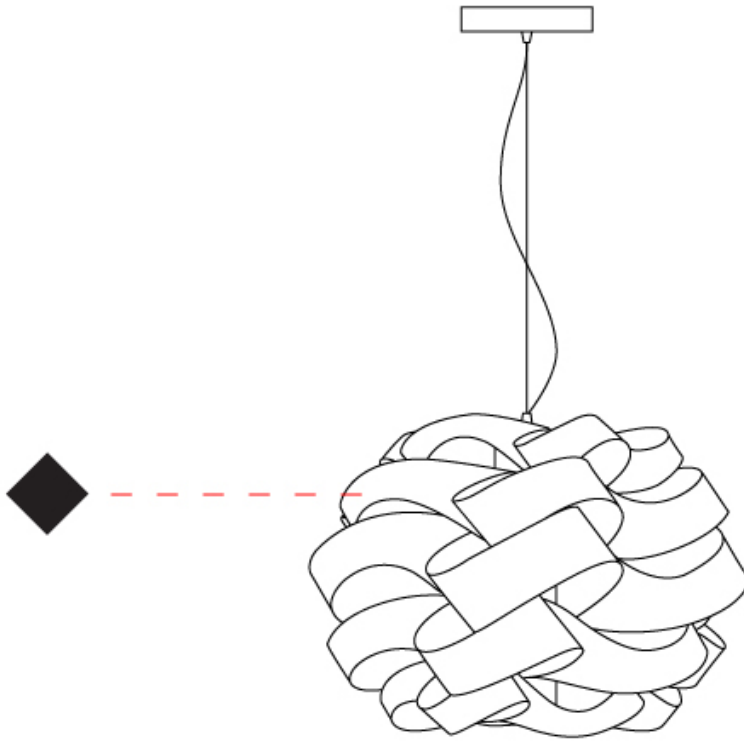

D

PROJECT
TYPE
SPECIFIER
QUANTITY
DATE

SKYLINE SURFACE

D62000-

base number Finish
Options

- To build a product code in our configurator select the specify button on the base model # product page
- To build a manual product code on this datasheet choose from the options listed below in blue font and add the suffix to the base model #

GENERAL

Series: Skyline
 Partner: Linea Zero
 Division: Design
 Installation: Surface
 Product Type: Ceiling Surface
 Mounting Location: Ceiling

PHYSICAL

Shape: Round
 Diameter (mm): 400
 Diameter (in): 15 3/4
 Height (mm): 190
 Height (in): 7 1/2
 Diffuser: Polilux™ Shade - See Finish Options
 Fixture Finish: WHI / BLK / SIL / NGD / COP / PKM
 Fixture Material: Polilux™/ Metal holder
 Primary Material: Non-Static Polilux

ELECTRICAL

Number of Lamps: 1
 Lamp Type: LED Retrofit
 Bulb Included: Bulb Not Included
 Max. Wattage Per Lamp (W): 7
 Lamp Base: E26
 Input Voltage (V): 120
 Upon Request: 277Vac / GU24

LED

OPTICAL

RATINGS AND CERTIFICATIONS

Certified By: Certified for North American Standards
 IP rating: IP20



Ø400mm 15 3/4"



SKYLINE SURFACE

D62000-

PROJECT

TYPE

SPECIFIER

QUANTITY

DATE

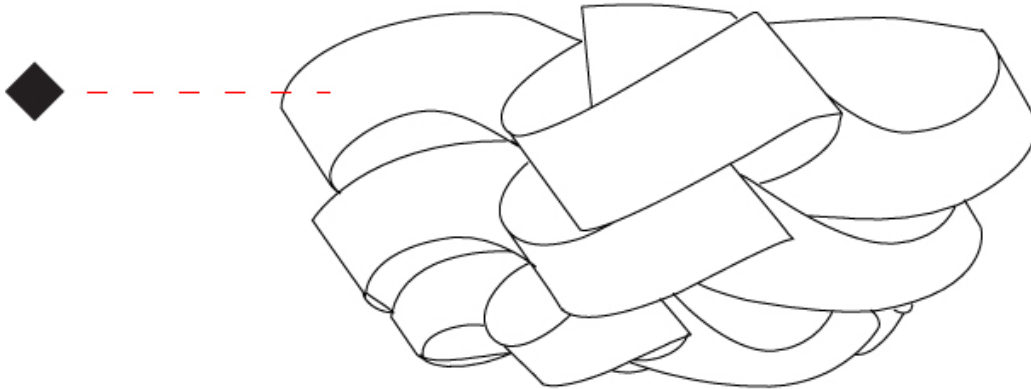

SKYLINE SURFACE

D62000- : D62000-WHI

base number

1. To build a product code in our configurator select the specify button on the base model # product page
2. To build a manual product code on this datasheet choose from the options listed below in blue font and add the suffix to the base model #

GENERAL

Series: Skyline
Partner: Linea Zero
Division: Design
Installation: Surface
Product Type: Ceiling Surface
Mounting Location: Ceiling

PHYSICAL

Shape: Round
Diameter (mm): 400
Diameter (in): 15 3/4
Height (mm): 190
Height (in): 7 1/2
Weight (kg): 1.3
Weight (lbs): 2.799
Diffuser: White Polilux^a Shade
Fixture Material: Polilux™/ Metal holder
Primary Material: Non-Static Polilux

ELECTRICAL

Number of Lamps: 1
Lamp Type: LED Retrofit
Bulb Included: Bulb Not Included
Total Output Wattage (W): 7
Max. Wattage Per Lamp (W): 7
Lamp Base: E26
Input Voltage (V): 120

LED

OPTICAL

RATINGS AND CERTIFICATIONS

Certified By: CSA Certified to UL and CSA Standards
IP rating: IP20

PROJECT	_____
TYPE	_____
SPECIFIER	_____
QUANTITY	_____
DATE	_____

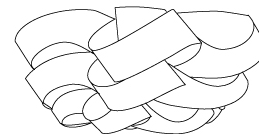

Ø400mm 15 3/4"



SKYLINE SURFACE

D62000- : D62000-WHI

PROJECT	_____
TYPE	_____
SPECIFIER	_____
QUANTITY	_____
DATE	_____

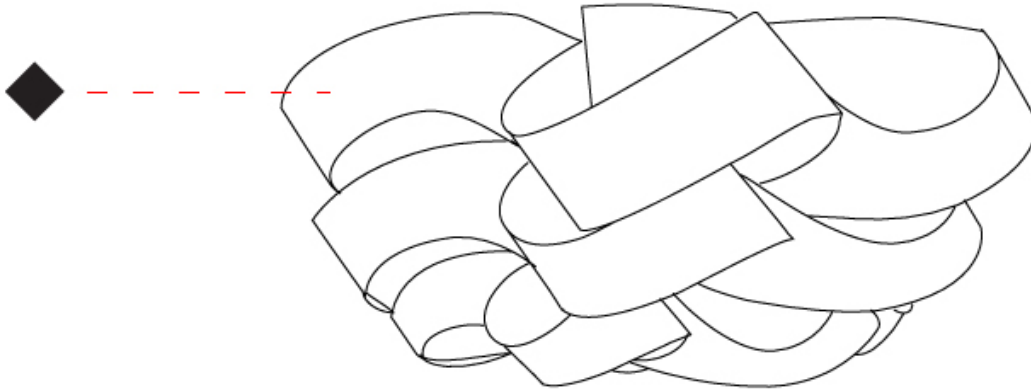

SKYLINE PORTABLE

D64047-

base number Finish
Options

PROJECT	_____
TYPE	_____
SPECIFIER	_____
QUANTITY	_____
DATE	_____

1. To build a product code in our configurator select the specify button on the base model # product page
2. To build a manual product code on this datasheet choose from the options listed below in blue font and add the suffix to the base model #

GENERAL

Series: Skyline _____
 Partner: Linea Zero _____
 Division: Design _____
 Installation: Portable _____
 Product Type: Table _____
 Mounting Location: Table _____

PHYSICAL

Shape: Round _____
 Diameter (mm): 400 _____
 Diameter (in): 15 3/4 _____
 Height (mm): 630 _____
 Height (in): 24 13/16 _____
 Diffuser: Polilux™ Shade - See Finish Options _____
 Fixture Finish: WHI / BLK / SIL / NGD / COP / PKM _____
 Fixture Material: Polilux™/ Metal holder _____
 Primary Material: Non-Static Polilux _____

ELECTRICAL

Number of Lamps: 1 _____
 Lamp Type: LED Retrofit _____
 Bulb Included: Bulb Not Included _____
 Max. Wattage Per Lamp (W): 7 _____
 Lamp Base: E26 _____
 Input Voltage (V): 120 _____
 Upon Request: 277Vac / GU24 _____

LED

OPTICAL

RATINGS AND CERTIFICATIONS

Certified By: Certified for North American Standards _____
 IP rating: IP20 _____

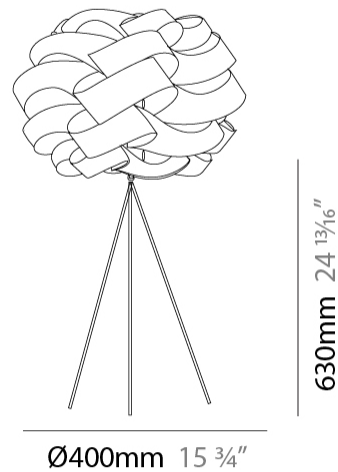

D64047-

PROJECT

TYPE

SPECIFIER

QUANTITY

DATE

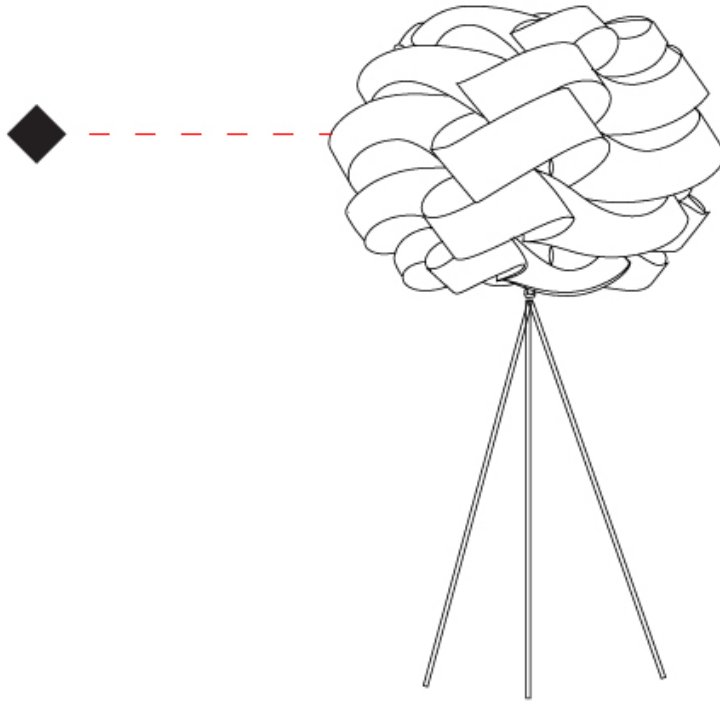

D

SKYLINE COLOR FINISH CHART

PROJECT _____

TYPE _____

SPECIFIER _____

QUANTITY _____

DATE _____

Fixture Finish

White - WHI



Black - BLK

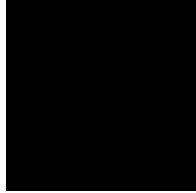

Silver - SIL



New Gold - NGD



Copper - COP



Pink Metal - PKM



Digital: Not all screens are calibrated the same, and therefore, colors will appear differently between screens.

Physical: When texture is involved, there will be variations in color, character and tone within a product series and between product families.



LEGEND

	floor-mounted		pivotal		special LED (upon request) RGB, RGBW, tunable, gold+, meat+, art+, fashion+
	wall and ceiling: recessed and surface mounted		rotating		warm dim / natural dimming LED
	ceiling-mounted and wall-mounted		illuminate tilted		rechargeable battery powered
	wall-mounted		color of suspension cable		fixture with natural vivid LED (upon request)
	omni-directional light distribution		length of suspension cable		color rendering index
	direct light distribution		reflector degree selection		color temperature
	direct/indirect light distribution		super spot		lumen (luminous flux)
	indirect light distribution		lens		efficacy (lumens per watt)
	asymmetric light distribution		lens pack		Unified Glare Rating (UGR) range from 5-40
	aura light distribution		shine ring		marine grade (AISI 316 stainless steel)
	round wall or ceiling cut-out		integrated shine ring with diffuser		walk on
	square wall or ceiling cut-out		free individual colors 01-29		drive on
	the supplied jig specifies the cutout dimensions		individual colors: 00 (free of charge), 01-25 (extra charge)		Dark Sky Compliance
	minimum distance (meters) lamp - object		luminaire part to be colored (F1)		Americans with Disabilities Act (less than 4" off the wall located between 27"-84" from floor)
	recessed depth		luminaire part to be colored (F2)		lamp protected against explosion
	ceiling thickness in mm		luminaire part to be colored (F3)		blown glass using traditional methods by master glass blower
	ceiling thickness selection		luminaire part to be colored (F4)		acoustic material
	dimnable DP (phase), DV (0-10V), DD (dali), DS (step-dim)		luminaire part to be colored (F5)		protection class I, protection insulation
	included or excluded LED driver/transformer/control gear		color of 3-circuit adaptor		protection class II, protection insulation
	separately switchable		indirect diffuser		ETL Certified to UL and CSA Standards
	sensor		direct diffuser		UL Certified to UL and CSA Standards
	remote control		ball-proof (upon request)		CSA Certified to UL and CSA Standards
	available upon request		accessory		Certified for North American Standards

IP RATING

	protected against ingress of solid bodies greater than 12.5mm (finger)
	protected against ingress of solid bodies greater than 2.5mm protected against sprays of water up to 60 degrees from the vertical (rain)
	protected against ingress of solid bodies greater than 1mm (wire) no protection against the ingress of moisture
	protected against ingress of solid bodies greater than 1mm (wire) protected against sprays of water up to 60 degrees from the vertical (rain)
	protected against ingress of solid bodies greater than 1mm (wire) protected against water splashed from all directions
	protected against limited ingress of dust (wet rooms/covered outdoor areas) protected against water splashed from all directions
	protected against ingress of dust protected against jets of water
	protected against ingress of dust protected against powerful jets of water or heavy seas
	protected against ingress of dust protected against immersion of water between 15cm - 1m for 30 minutes
	protected against ingress of dust protected against immersion of water under pressure for long periods

IK RATING

	protected against 0.14 joules impact (equivalent to 0.25kg mass dropped from 56mm above the surface)
	protected against 0.2 joules impact (equivalent to 0.25kg mass dropped from 80mm above the surface)
	protected against 0.35 joules impact (equivalent to 0.25kg mass dropped from 140mm above the surface)
	protected against 0.5 joules impact (equivalent to 0.25kg mass dropped from 200mm above the surface)
	protected against 0.7 joules impact (equivalent to 0.25kg mass dropped from 280mm above the surface)
	protected against 1 joules impact (equivalent to 0.25kg mass dropped from 400mm above the surface)
	protected against 2 joules impact (equivalent to 0.5kg mass dropped from 400mm above the surface)
	protected against 5 joules impact (equivalent to 1.7kg mass dropped from 300mm above the surface)
	protected against 10 joules impact (equivalent to 5.0kg mass dropped from 200mm above the surface)
	protected against 20 joules impact (equivalent to 5.0kg mass dropped from 400mm above the surface)