

SPARKS DOUBLE HEAD SURFACE

D103134-

base number _____
 Finish _____
 Options _____

- To build a product code in our configurator select the specify button on the base model # product page
- To build a manual product code on this datasheet choose from the options listed below in blue font and add the suffix to the base model #

GENERAL

Series: Sparks _____
 Subseries: Sparks Double Head _____
 Brand: Quasar _____
 Division: Design _____
 Mounting Type: Surface _____
 Mounting Location: Wall _____
 Subcategory: Ambient _____

PHYSICAL

Shape: Abstract _____
 Length (mm): 225 _____
 Length (in): 8 7/8 _____
 Height (mm): 330 _____
 Depth (mm): 190 _____
 Height (in): 13 _____
 Depth (in): 7 1/2 _____
 Light Distribution: Omnidirectional _____
 Weight (kg): 3 _____
 Weight (lbs): 6.6 _____
 Fixture Finish: WHI / PAL _____
 Fixture Material: Metal _____

ELECTRICAL

Lamp Type: LED _____
 Input Wattage (W): 4.2 _____
 Total Output Wattage (W): 3.2 _____
 Dimming: Non-Dimmable _____
 Driver Included: Yes _____
 Driver Location: Integrated _____
 Driver Type: Constant Current - Universal _____
 Driver Class: Class 2 _____
 Input Voltage (V): 120 - 277 _____
 Constant Current (MA): 350 _____
 Upon Request: (Not included - see components) Remote: 0-10Vdc dimming / Phase dimming @120Vac only _____

LED

Number of LEDs: 1 _____
 Color Temperature (°K): 2700 _____
 Max. Delivered Lumen (lm): 376 _____
 CRI: >90 CRI _____
 Lamp Life (hrs): 50000 _____

OPTICAL

RATINGS AND CERTIFICATIONS

Certified By: Certified for North American Standards _____
 IP rating: IP20 _____

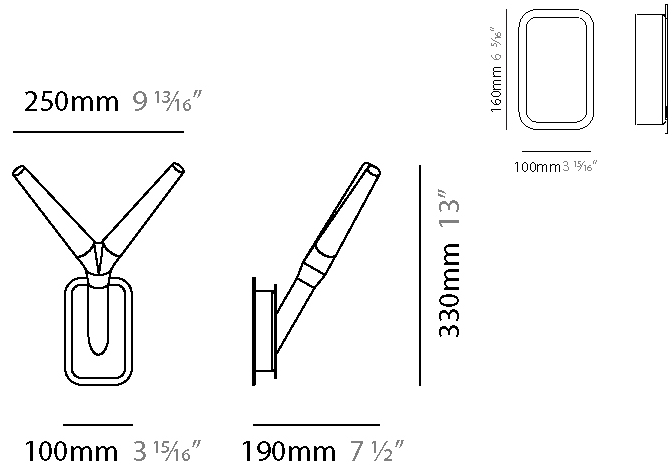

SPARKS DOUBLE HEAD SURFACE

D103134-

PROJECT	_____
TYPE	_____
SPECIFIER	_____
QUANTITY	_____
DATE	_____

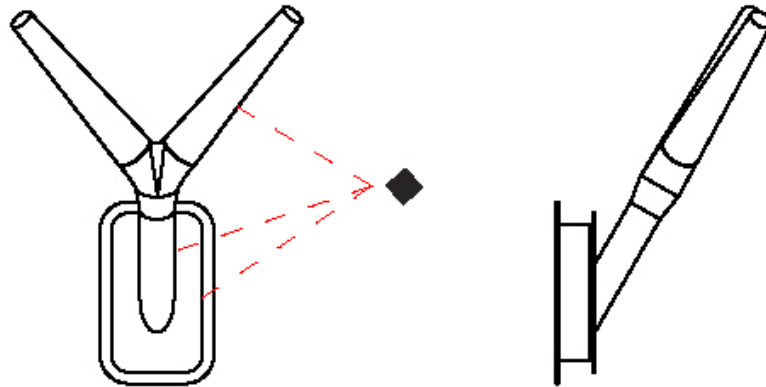

SPARKS TRIPLE HEAD SURFACE

D103136-

base number _____
 Finish _____
 Options _____

- To build a product code in our configurator select the specify button on the base model # product page
- To build a manual product code on this datasheet choose from the options listed below in blue font and add the suffix to the base model #

GENERAL

Series: Sparks _____
 Subseries: Sparks Triple Head _____
 Brand: Quasar _____
 Division: Design _____
 Mounting Type: Surface _____
 Mounting Location: Wall _____
 Subcategory: Ambient _____

PHYSICAL

Shape: Abstract _____
 Length (mm): 270 _____
 Length (in): 10 ⁵/₈ _____
 Height (mm): 340 _____
 Depth (mm): 290 _____
 Height (in): 13 ³/₈ _____
 Depth (in): 11 ¹/₁₆ _____
 Light Distribution: Omnidirectional _____
 Weight (kg): 3 _____
 Weight (lbs): 6.6 _____
 Fixture Finish: WHI / PAL _____
 Fixture Material: Metal _____

ELECTRICAL

Lamp Type: LED _____
 Input Wattage (W): 4.2 _____
 Total Output Wattage (W): 1.2 _____
 Dimming: Non-Dimmable _____
 Driver Included: Yes _____
 Driver Location: Integrated _____
 Driver Type: Constant Current - Universal _____
 Driver Class: Class 2 _____
 Input Voltage (V): 120 - 277 _____
 Constant Current (MA): 350 _____
 Upon Request: (Not included - see components) Remote: 0-10Vdc dimming / Phase dimming @120Vac only

LED

Number of LEDs: 1 _____
 Color Temperature (°K): 2700 _____
 Max. Delivered Lumen (lm): 376 _____
 CRI: >90 CRI _____
 Lamp Life (hrs): 50000 _____

OPTICAL

RATINGS AND CERTIFICATIONS

Certified By: Certified for North American Standards _____
 IP rating: IP20 _____



250mm 9 13/16"

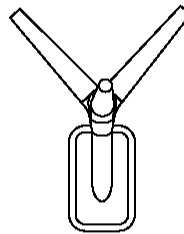

100mm 3 15/16"

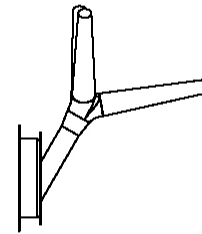

290mm 11 7/16"

340mm 13 3/8"

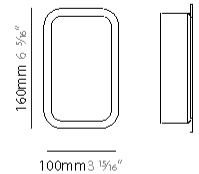

SPARKS TRIPLE HEAD SURFACE

D103136-

PROJECT
TYPE
SPECIFIER
QUANTITY
DATE



PROJECT	_____
TYPE	_____
SPECIFIER	_____
QUANTITY	_____
DATE	_____

SPARKS 7 SURFACE

D103142-

base number	LED Dimming	Finish Options
-------------	-------------	----------------

- To build a product code in our configurator select the specify button on the base model # product page
- To build a manual product code on this datasheet choose from the options listed below in blue font and add the suffix to the base model #

GENERAL

Series: Sparks
Subseries: Sparks 7
Brand: Quasar
Division: Design
Mounting Type: Surface
Mounting Location: Wall
Subcategory: Ambient

PHYSICAL

Shape: Abstract
Length (mm): 1100
Length (in): 43 ⁵ / ₁₆
Height (mm): 1800
Depth (mm): 900
Height (in): 70 ⁷ / ₈
Depth (in): 35 ⁷ / ₁₆
Light Distribution: Omnidirectional
Fixture Finish: WHI / PAL
Fixture Material: Metal

ELECTRICAL

Lamp Type: LED
Input Wattage (W): 32.2
Total Output Wattage (W): 22.4
Dimming: Non-Dimming / Phase Dimming (120Vac only) / 0-10V Dimming
Driver Included: Yes
Driver Location: Integrated
Driver Type: Constant Voltage - Universal
Driver Class: Class 2
Input Voltage (V): 120 - 277
Output Voltage (V): 24

LED

Number of LEDs: 7
Color Temperature (°K): 2700
Max. Delivered Lumen (lm): 2632
CRI: >90 CRI
Lamp Life (hrs): 50000

OPTICAL

RATINGS AND CERTIFICATIONS

Certified By: Certified for North American Standards
IP rating: IP20

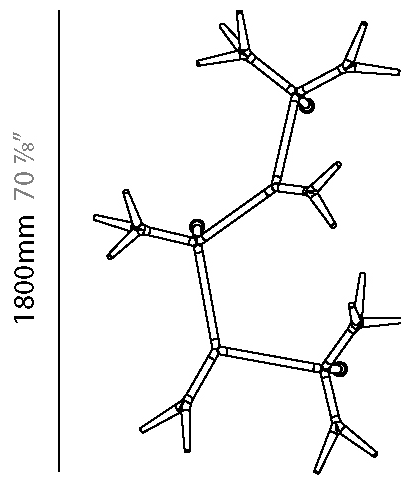
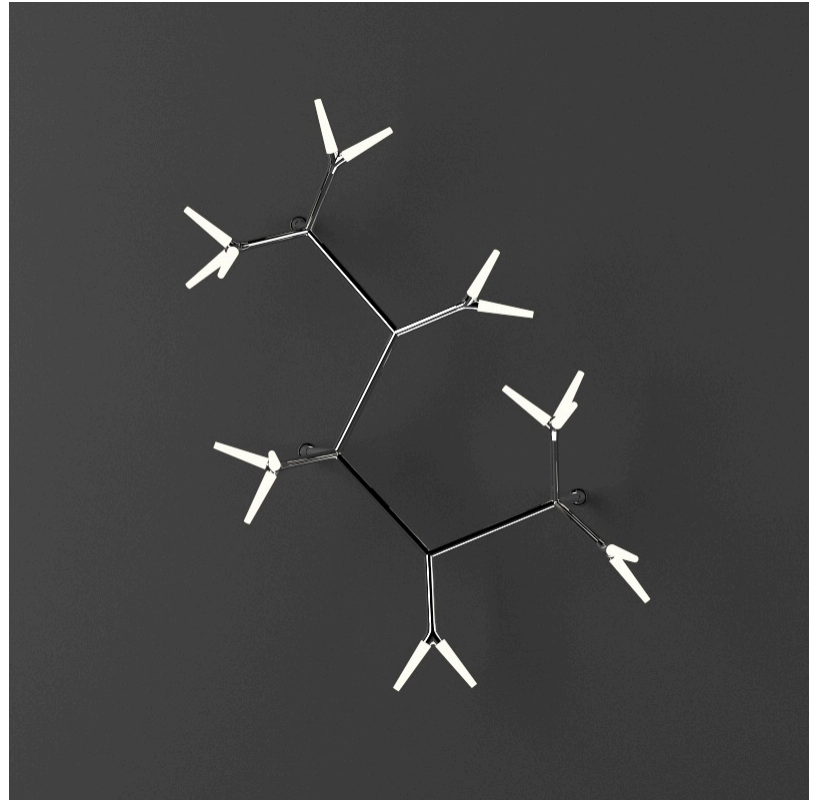

1800mm 70 ⁷/₈"

1100mm 43 ⁵/₁₆"

100mm 3 ¹⁵/₁₆"
50mm 1 ¹⁵/₁₆"

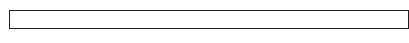

350mm 13 ³/₄"



SPARKS 7 SURFACE

D103142-

PROJECT	_____
TYPE	_____
SPECIFIER	_____
QUANTITY	_____
DATE	_____

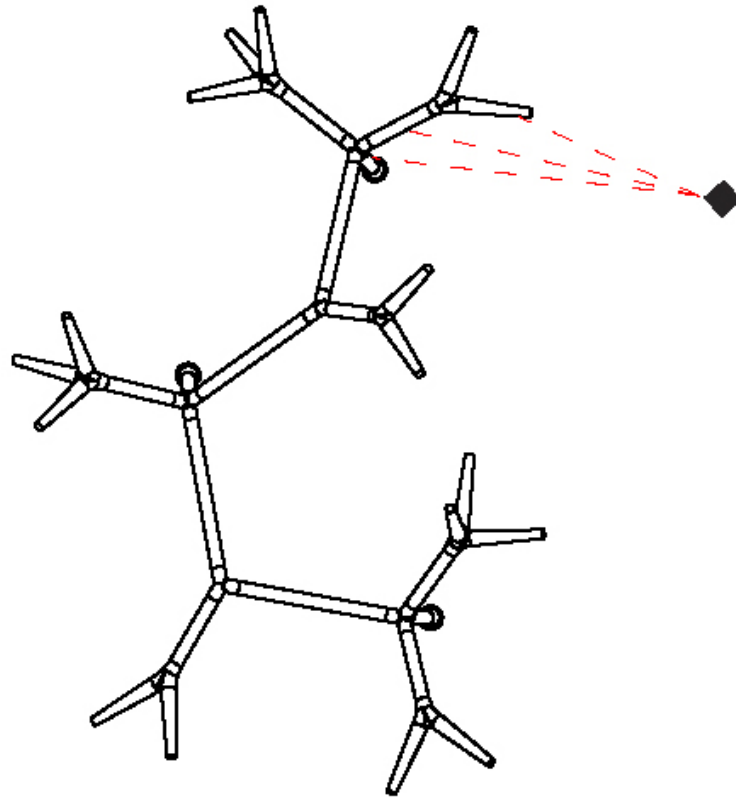

D

PROJECT	_____
TYPE	_____
SPECIFIER	_____
QUANTITY	_____
DATE	_____

SPARKS 9 SURFACE

D103143-

base number	LED Dimming	Finish Options
-------------	-------------	----------------

- To build a product code in our configurator select the specify button on the base model # product page
- To build a manual product code on this datasheet choose from the options listed below in blue font and add the suffix to the base model #

GENERAL

Series: Sparks
Subseries: Sparks 9
Brand: Quasar
Division: Design
Mounting Type: Surface
Mounting Location: Wall
Subcategory: Ambient

PHYSICAL

Shape: Abstract
Length (mm): 1200
Length (in): 47 1/4
Height (mm): 2400
Depth (mm): 900
Height (in): 94 1/2
Depth (in): 35 7/16
Light Distribution: Omnidirectional
Fixture Finish: WHI / PAL
Fixture Material: Metal

ELECTRICAL

Lamp Type: LED
Input Wattage (W): 41.4
Total Output Wattage (W): 28.8
Dimming: Non-Dimming / Phase Dimming (120Vac only) / 0-10V Dimming
Driver Included: Yes
Driver Location: Integrated
Driver Type: Constant Voltage - Universal
Driver Class: Class 2
Input Voltage (V): 120 - 277
Output Voltage (V): 24

LED

Number of LEDs: 9
Color Temperature (°K): 2700
Max. Delivered Lumen (lm): 3384
CRI: >90 CRI
Lamp Life (hrs): 50000

OPTICAL

RATINGS AND CERTIFICATIONS

Certified By: Certified for North American Standards
IP rating: IP20

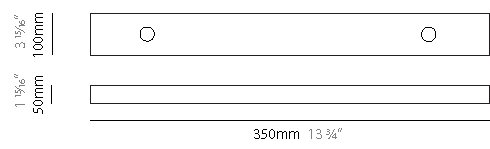
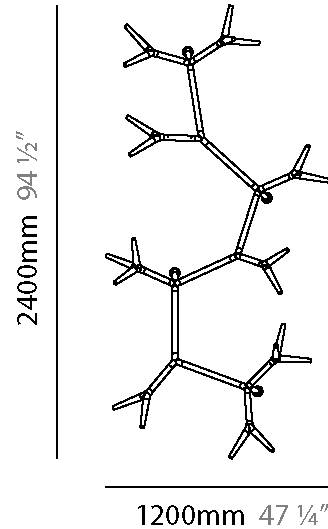
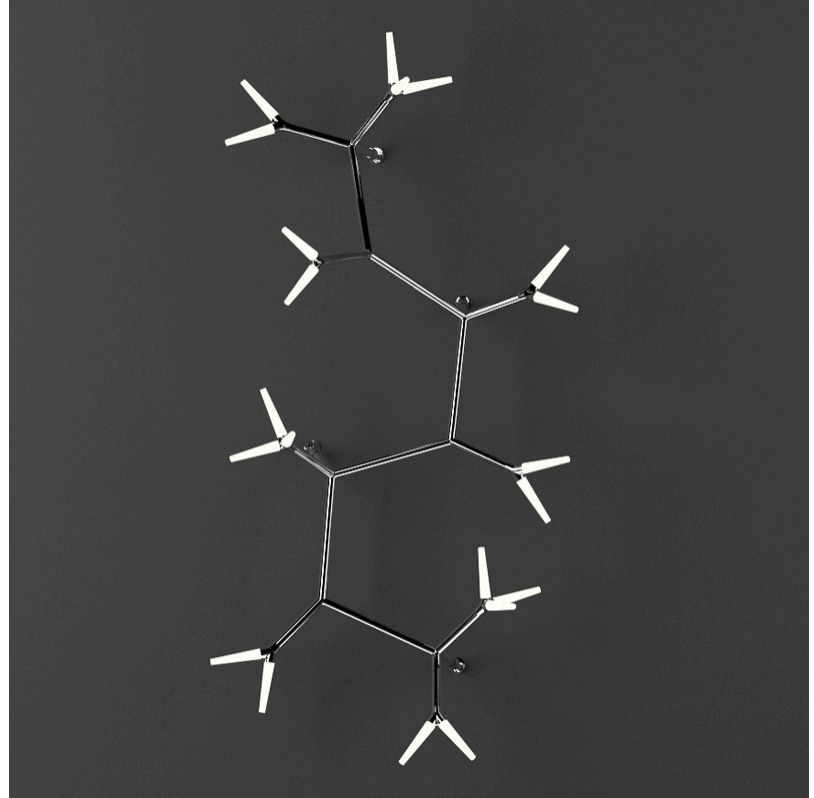

SPARKS 9 SURFACE

D103143-

PROJECT

TYPE

SPECIFIER

QUANTITY

DATE

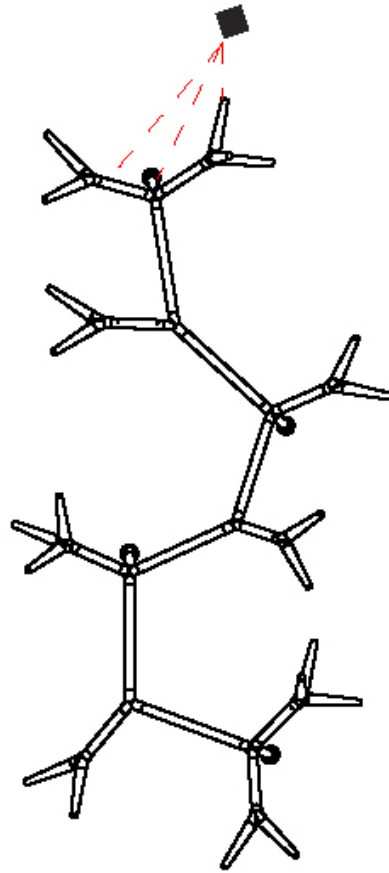

D

SPARKS 11 SURFACE

D103145-

base number LED Finish
 Dimming Options

- To build a product code in our configurator select the specify button on the base model # product page
- To build a manual product code on this datasheet choose from the options listed below in blue font and add the suffix to the base model #

GENERAL

Series: Sparks
 Subseries: Sparks 11
 Brand: Quasar
 Division: Design
 Mounting Type: Surface
 Mounting Location: Wall
 Subcategory: Ambient

PHYSICAL

Shape: Abstract
 Length (mm): 1700
 Length (in): 66 ¹⁵/₁₆
 Height (mm): 2600
 Depth (mm): 900
 Height (in): 102 ³/₈
 Depth (in): 35 ⁷/₁₆
 Light Distribution: Omnidirectional
 Fixture Finish: WHI / PAL
 Fixture Material: Metal

ELECTRICAL

Lamp Type: LED
 Input Wattage (W): 50.6
 Total Output Wattage (W): 35.2
 Dimming: Non-Dimming / Phase Dimming (120Vac only) / 0-10V Dimming
 Driver Included: Yes
 Driver Location: Integrated
 Driver Type: Constant Voltage - Universal
 Driver Class: Class 2
 Input Voltage (V): 120 - 277
 Output Voltage (V): 24

LED

Number of LEDs: 11
 Color Temperature (°K): 2700
 Max. Delivered Lumen (lm): 4136
 CRI: >90 CRI
 Lamp Life (hrs): 50000

OPTICAL

RATINGS AND CERTIFICATIONS

Certified By: Certified for North American Standards
 IP rating: IP20

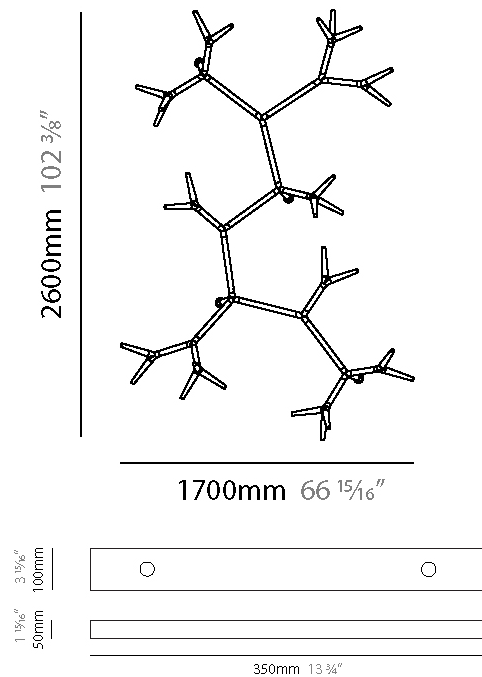
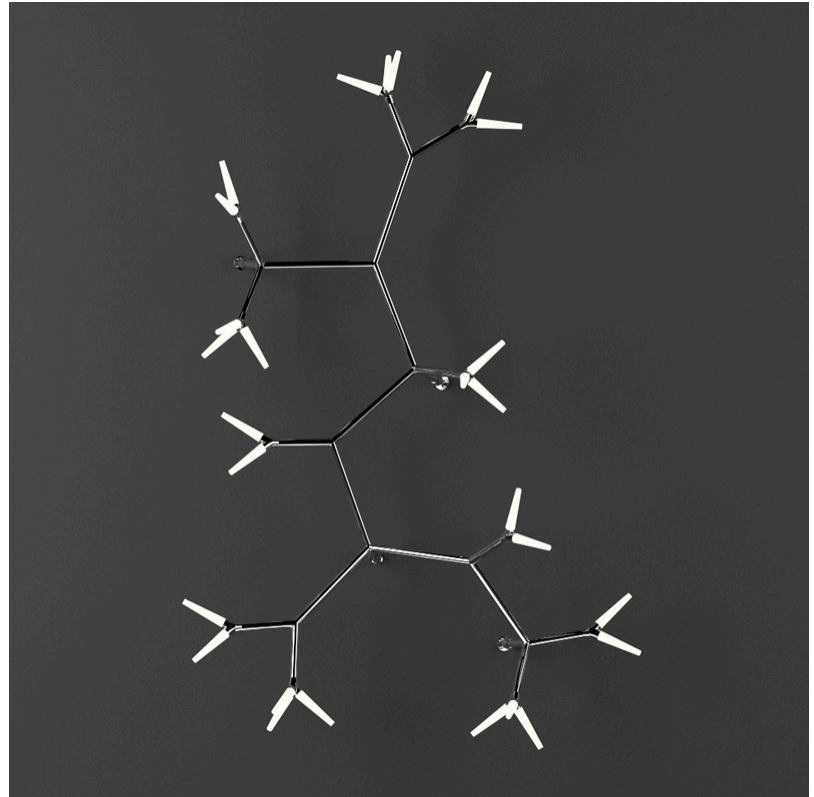

SPARKS 11 SURFACE

D103145-

PROJECT

TYPE

SPECIFIER

QUANTITY

DATE

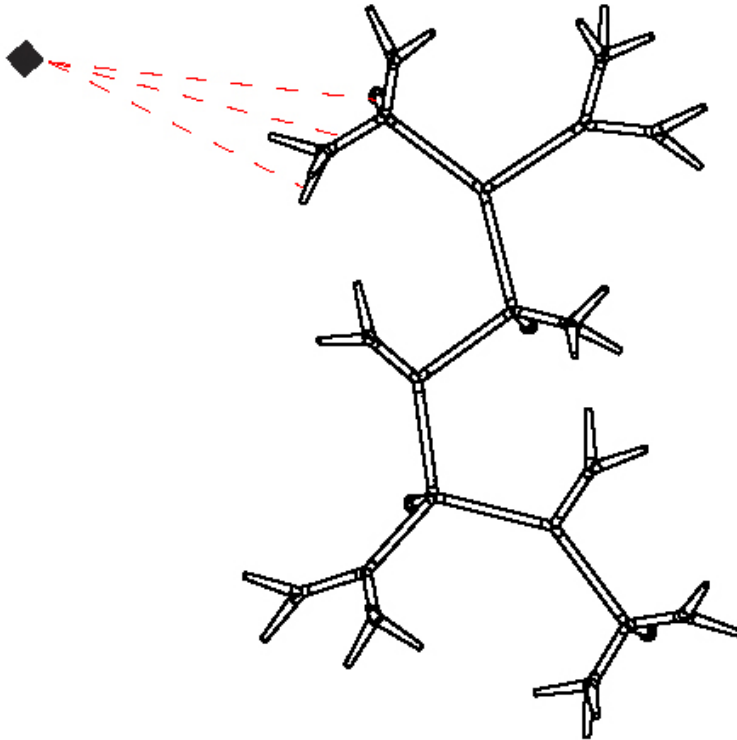

D

SPARKS 15 SURFACE

D103147-

base number LED Dimming Finish Options

PROJECT
TYPE
SPECIFIER
QUANTITY
DATE

- To build a product code in our configurator select the specify button on the base model # product page
- To build a manual product code on this datasheet choose from the options listed below in blue font and add the suffix to the base model #

GENERAL

Series: Sparks
 Subseries: Sparks 15
 Brand: Quasar
 Division: Design
 Mounting Type: Surface
 Mounting Location: Wall
 Subcategory: Ambient

PHYSICAL

Shape: Abstract
 Length (mm): 1900
 Length (in): 74 ¹³/₁₆
 Height (mm): 3340
 Depth (mm): 900
 Height (in): 131 ¹/₂
 Depth (in): 35 ⁷/₁₆
 Light Distribution: Omnidirectional
 Weight (kg): 17
 Weight (lbs): 37.48
 Fixture Finish: WHI / PAL
 Fixture Material: Metal

ELECTRICAL

Lamp Type: LED
 Input Wattage (W): 69
 Total Output Wattage (W): 48
 Dimming: Non-Dimming / Phase Dimming (120Vac only) / 0-10V Dimming
 Driver Included: Yes
 Driver Location: Integrated
 Driver Type: Constant Voltage - Universal
 Driver Class: Class 2
 Input Voltage (V): 120 - 277
 Output Voltage (V): 24

LED

Number of LEDs: 15
 Color Temperature (°K): 2700
 Max. Delivered Lumen (lm): 5640
 CRI: >90 CRI
 Lamp Life (hrs): 50000

OPTICAL

RATINGS AND CERTIFICATIONS

Certified By: Certified for North American Standards
 IP rating: IP20

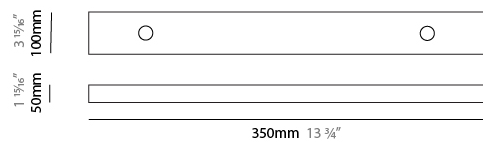
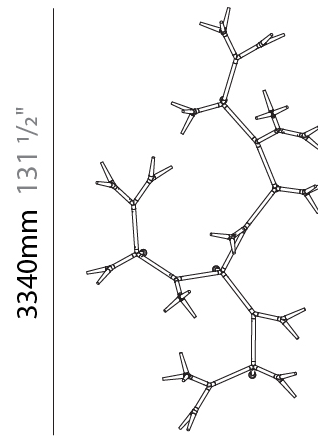
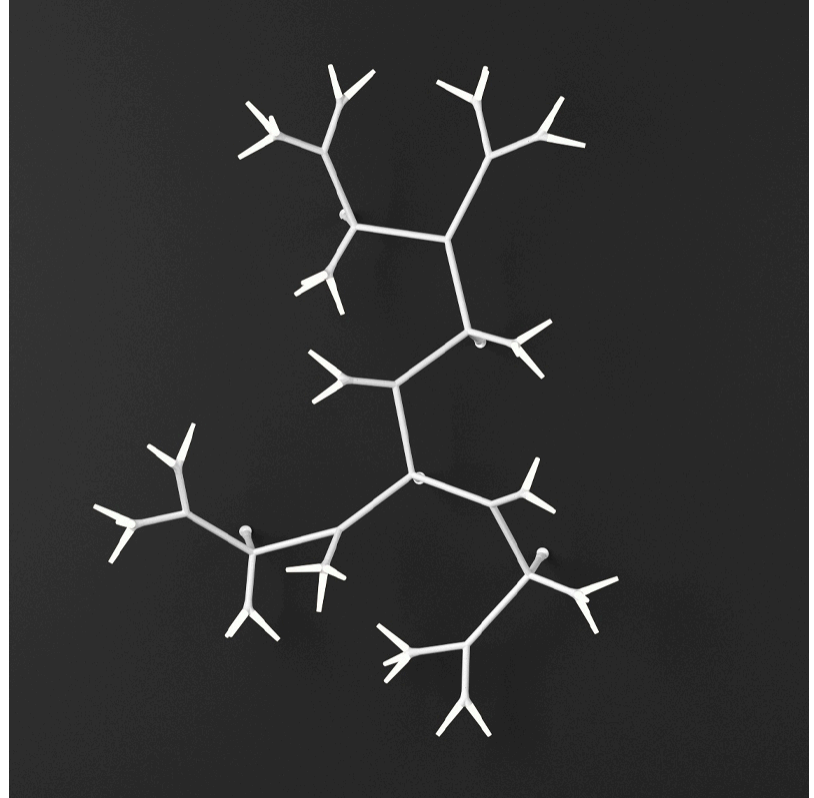

D103147-

PROJECT

TYPE

SPECIFIER

QUANTITY

DATE

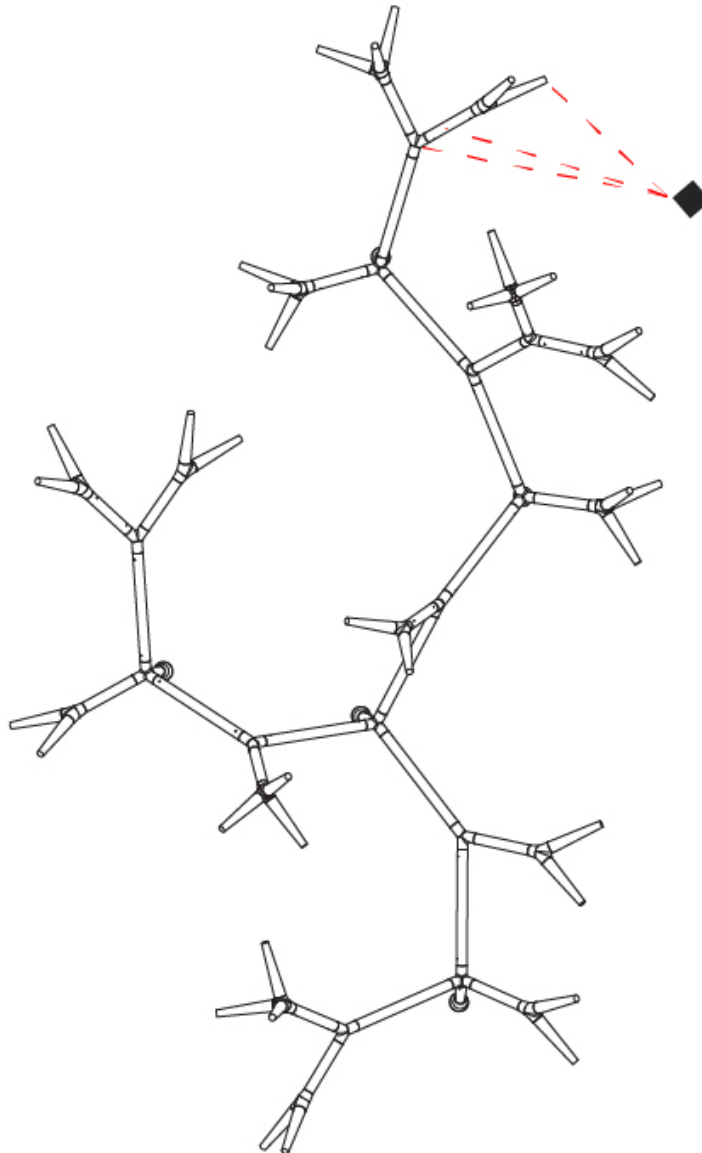

D

SPARKS 17 SURFACE

D103148-

base number LED Dimming Finish Options

- To build a product code in our configurator select the specify button on the base model # product page
- To build a manual product code on this datasheet choose from the options listed below in blue font and add the suffix to the base model #

GENERAL

Series: Sparks
 Subseries: Sparks 17
 Brand: Quasar
 Division: Design
 Mounting Type: Surface
 Mounting Location: Wall
 Subcategory: Ambient

PHYSICAL

Shape: Abstract
 Length (mm): 2590
 Length (in): 101 ¹⁵/₁₆
 Height (mm): 3250
 Depth (mm): 900
 Height (in): 127 ¹⁵/₁₆
 Depth (in): 35 ⁷/₁₆
 Light Distribution: Omnidirectional
 Weight (kg): 21
 Weight (lbs): 46.30
 Fixture Finish: WHI / PAL
 Fixture Material: Metal

ELECTRICAL

Lamp Type: LED
 Input Wattage (W): 78.2
 Total Output Wattage (W): 54.4
 Dimming: Non-Dimming / Phase Dimming (120Vac only) / 0-10V Dimming
 Driver Included: Yes
 Driver Location: Integrated
 Driver Type: Constant Voltage - Universal
 Driver Class: Class 2
 Input Voltage (V): 120 - 277
 Output Voltage (V): 24

LED

Number of LEDs: 17
 Color Temperature (°K): 2700
 Max. Delivered Lumen (lm): 6392
 CRI: >90 CRI
 Lamp Life (hrs): 50000

OPTICAL

RATINGS AND CERTIFICATIONS

Certified By: Certified for North American Standards
 IP rating: IP20

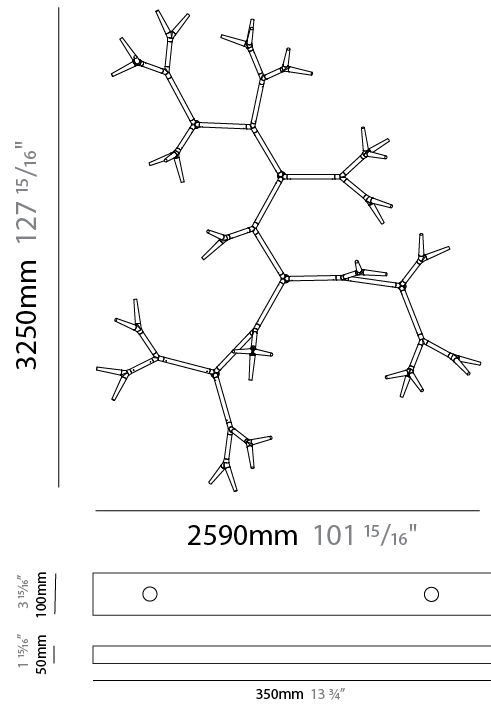
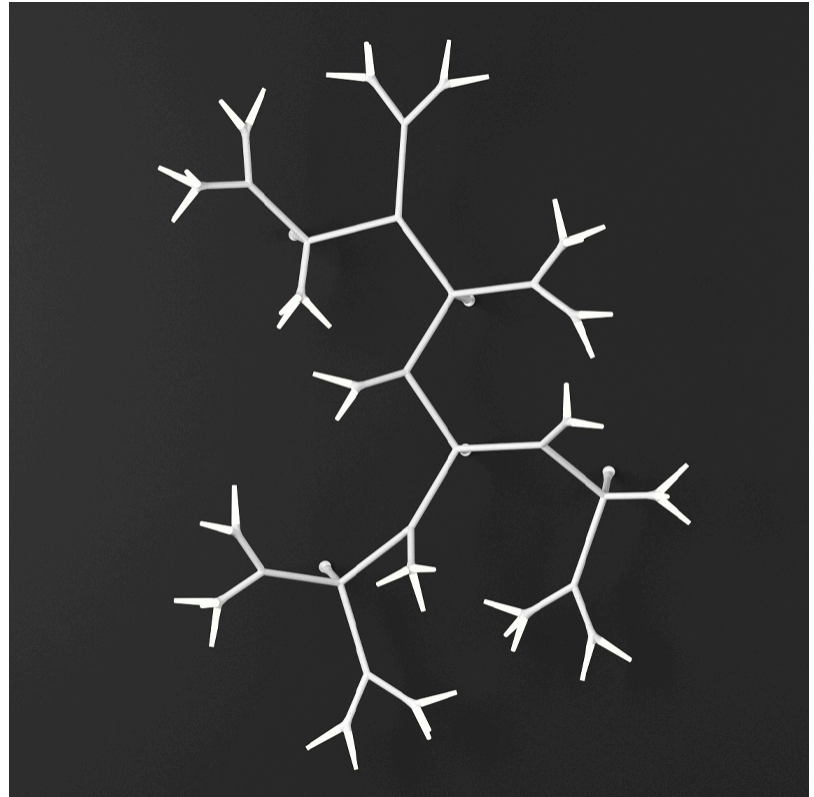

SPARKS 17 SURFACE

D103148-

PROJECT

TYPE

SPECIFIER

QUANTITY

DATE

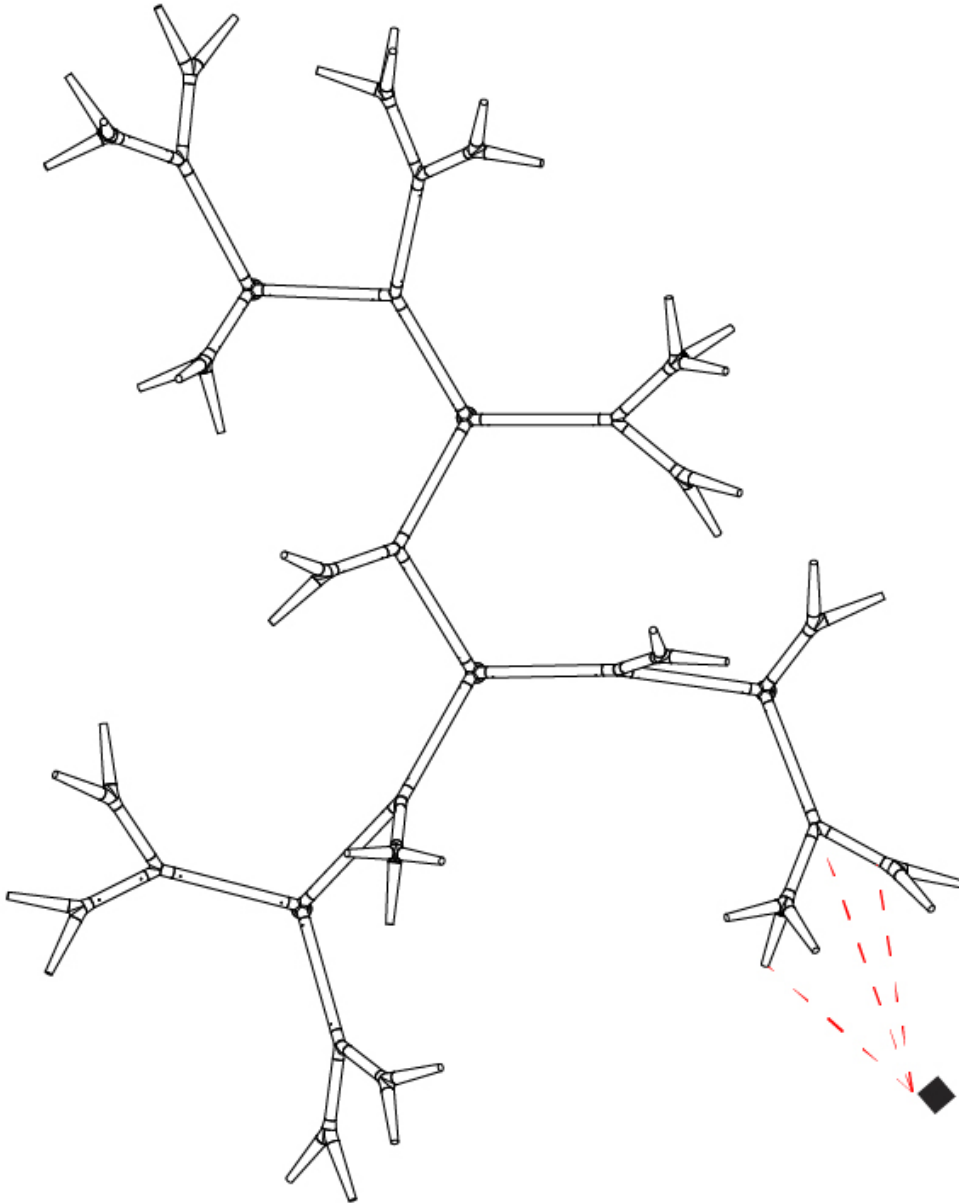

D

PROJECT	
TYPE	
SPECIFIER	
QUANTITY	
DATE	

SPARKS 19 SURFACE

D103149-

base number	LED Dimming	Finish Options
-------------	-------------	----------------

- To build a product code in our configurator select the specify button on the base model # product page
- To build a manual product code on this datasheet choose from the options listed below in blue font and add the suffix to the base model #

GENERAL

Series: Sparks
Subseries: Sparks 19
Brand: Quasar
Division: Design
Mounting Type: Surface
Mounting Location: Wall
Subcategory: Ambient

PHYSICAL

Shape: Abstract
Length (mm): 1880
Length (in): 74
Height (mm): 5300
Depth (mm): 900
Height (in): 208 ¹¹ / ₁₆
Depth (in): 35 ⁷ / ₁₆
Light Distribution: Omnidirectional
Weight (kg): 24
Weight (lbs): 52.91
Fixture Finish: WHI / PAL
Fixture Material: Metal

ELECTRICAL

Lamp Type: LED
Input Wattage (W): 87.4
Total Output Wattage (W): 60.8
Dimming: 0-10V Dimming / Phase Dimming (120Vac Only)
Driver Included: Yes
Driver Location: Integrated
Driver Type: Constant Voltage - Universal
Driver Class: Class 2
Input Voltage (V): 120 - 277
Output Voltage (V): 24

LED

Number of LEDs: 19
Color Temperature (°K): 2700
Max. Delivered Lumen (lm): 7144
CRI: >90 CRI
Lamp Life (hrs): 50000

OPTICAL

RATINGS AND CERTIFICATIONS

Certified By: Certified for North American Standards
IP rating: IP20

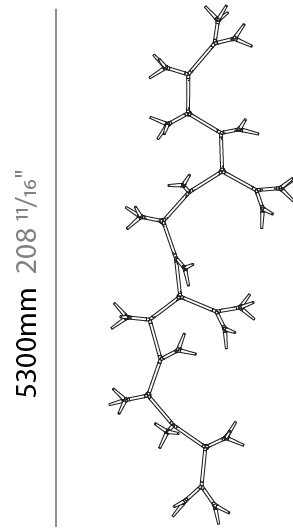
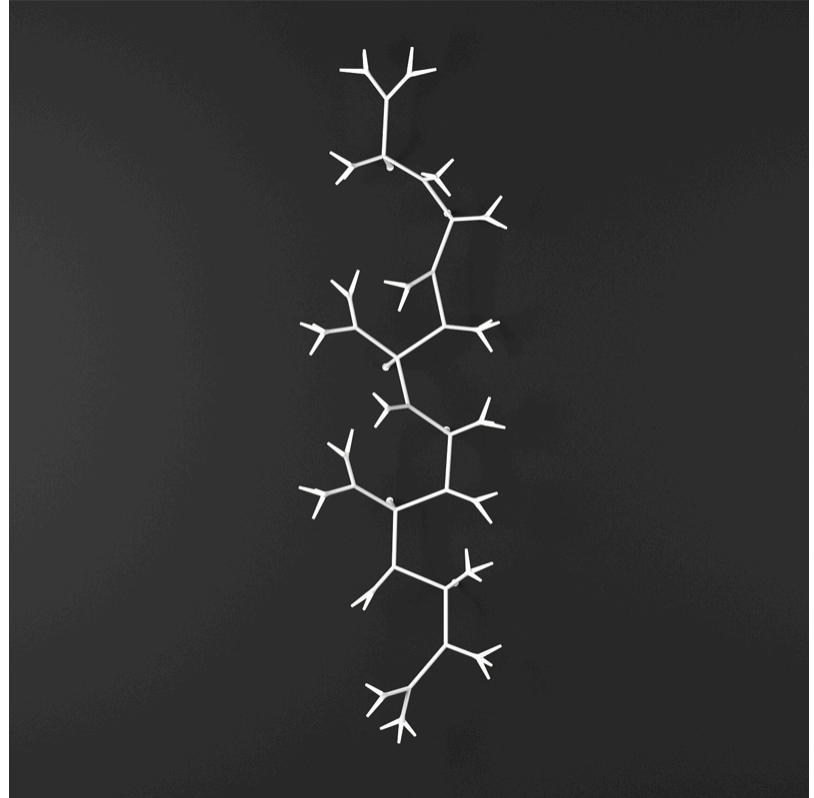

1880mm 74"

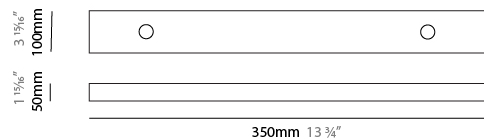

D103149-

PROJECT

TYPE

SPECIFIER

QUANTITY

DATE

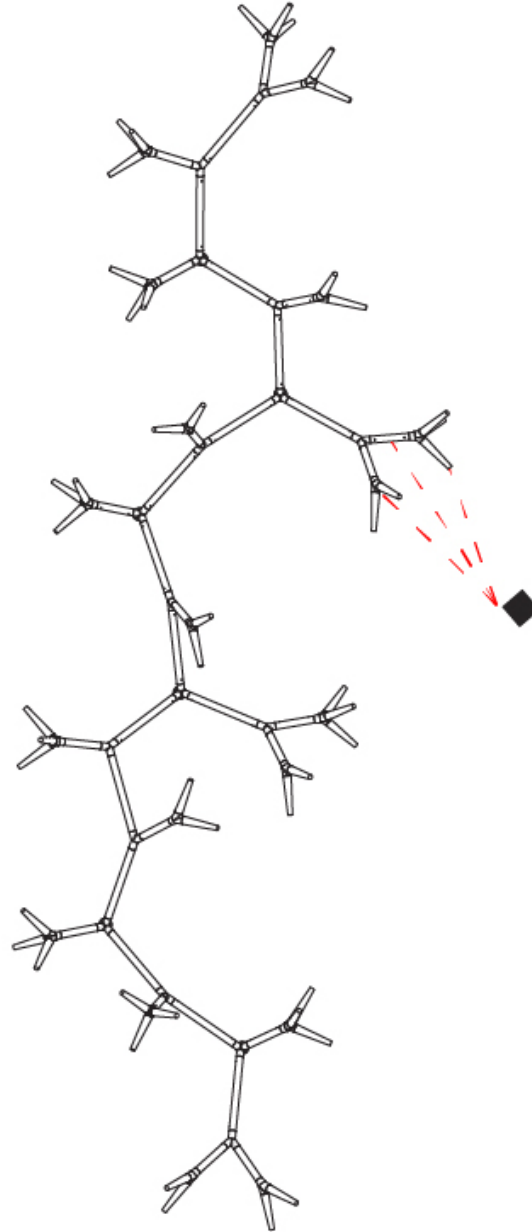

D

SPARKS

COLOR FINISH CHART

PROJECT

TYPE

SPECIFIER

QUANTITY

DATE

Fixture Finish

White - WHI



Polished Aluminum - PAL

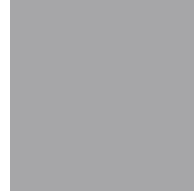

Digital: Not all screens are calibrated the same, and therefore, colors will appear differently between screens.

Physical: When texture is involved, there will be variations in color, character and tone within a product series and between product families.



PROJECT	
TYPE	
SPECIFIER	
QUANTITY	
DATE	

LEGEND

floor-mounted	pivotal	special LED (upon request) RGB, RGBW, tunable, gold+, meat+, art+, fashion+
wall and ceiling: recessed and surface mounted	rotating	warm dim / natural dimming LED
ceiling-mounted and wall-mounted	illuminate tilted	rechargeable battery powered
wall-mounted	color of suspension cable	fixture with natural vivid LED (upon request)
omni-directional light distribution	length of suspension cable	color rendering index
direct light distribution	reflector degree selection	color temperature
direct/indirect light distribution	super spot	lumen (luminous flux)
indirect light distribution	lens	efficacy (lumens per watt)
asymmetric light distribution	lens pack	Unified Glare Rating (UGR) range from 5-40
aura light distribution	shine ring	marine grade (AISI 316 stainless steel)
round wall or ceiling cut-out	integrated shine ring with diffuser	walk on
square wall or ceiling cut-out	free individual colors 01-29	drive on
the supplied jig specifies the cutout dimensions	individual colors: 00 (free of charge), 01-25 (extra charge)	Dark Sky Compliance
minimum distance (meters) lamp - object	luminaire part to be colored (F1)	Americans with Disabilities Act (less than 4" off the wall located between 27"-84" from floor)
recessed depth	luminaire part to be colored (F2)	lamp protected against explosion
ceiling thickness in mm	luminaire part to be colored (F3)	blown glass using traditional methods by master glass blower
ceiling thickness selection	luminaire part to be colored (F4)	acoustic material
dimmable DP (phase), DV (0-10V), DD (dali), DS (step-dim)	luminaire part to be colored (F5)	protection class I, protection insulation
included or excluded LED driver/transformer/control gear	color of 3-circuit adaptor	protection class II, protection insulation
separately switchable	indirect diffuser	ETL Certified to UL and CSA Standards
sensor	direct diffuser	UL Certified to UL and CSA Standards
remote control	ball-proof (upon request)	CSA Certified to UL and CSA Standards
available upon request	accessory	Certified for North American Standards

IP RATING

IP20	protected against ingress of solid bodies greater than 12.5mm (finger)
IP33	protected against ingress of solid bodies greater than 2.5mm protected against sprays of water up to 60 degrees from the vertical (rain)
IP40	protected against ingress of solid bodies greater than 1mm (wire) no protection against the ingress of moisture
IP43	protected against ingress of solid bodies greater than 1mm (wire) protected against sprays of water up to 60 degrees from the vertical (rain)
IP44	protected against ingress of solid bodies greater than 1mm (wire) protected against water splashed from all directions
IP54	protected against limited ingress of dust (wet rooms/covered outdoor areas) protected against water splashed from all directions
IP65	protected against ingress of dust protected against jets of water
IP66	protected against ingress of dust protected against powerful jets of water or heavy seas
IP67	protected against ingress of dust protected against immersion of water between 15cm - 1m for 30 minutes
IP68	protected against ingress of dust protected against immersion of water under pressure for long periods

IK RATING

IK01	protected against 0.14 joules impact (equivalent to 0.25kg mass dropped from 56mm above the surface)
IK02	protected against 0.2 joules impact (equivalent to 0.25kg mass dropped from 80mm above the surface)
IK03	protected against 0.35 joules impact (equivalent to 0.25kg mass dropped from 140mm above the surface)
IK04	protected against 0.5 joules impact (equivalent to 0.25kg mass dropped from 200mm above the surface)
IK05	protected against 0.7 joules impact (equivalent to 0.25kg mass dropped from 280mm above the surface)
IK06	protected against 1 joules impact (equivalent to 0.25kg mass dropped from 400mm above the surface)
IK07	protected against 2 joules impact (equivalent to 0.5kg mass dropped from 400mm above the surface)
IK08	protected against 5 joules impact (equivalent to 1.7kg mass dropped from 300mm above the surface)
IK09	protected against 10 joules impact (equivalent to 5.0kg mass dropped from 200mm above the surface)
IK10	protected against 20 joules impact (equivalent to 5.0kg mass dropped from 400mm above the surface)