

PROJECT	_____
TYPE	_____
SPECIFIER	_____
QUANTITY	_____
DATE	_____

SPARKS DOUBLE HEAD SURFACE

D103134-

base number Finish
Options

- To build a product code in our configurator select the specify button on the base model # product page
- To build a manual product code on this datasheet choose from the options listed below in blue font and add the suffix to the base model #

GENERAL

Series: Sparks
 Subseries: Sparks Double Head
 Brand: Quasar
 Division: Design
 Mounting Type: Surface
 Mounting Location: Wall
 Subcategory: Ambient

PHYSICAL

Shape: Abstract
 Length (mm): 225
 Length (in): 8 7/8
 Height (mm): 330
 Depth (mm): 190
 Height (in): 13
 Depth (in): 7 1/2
 Light Distribution: Omnidirectional
 Weight (kg): 3
 Weight (lbs): 6.6
 Fixture Finish: WHI / PAL
 Fixture Material: Metal

ELECTRICAL

Lamp Type: LED
 Input Wattage (W): 4.2
 Total Output Wattage (W): 3.2
 Dimming: Non-Dimmable
 Driver Included: Yes
 Driver Location: Integrated
 Driver Type: Constant Current - Universal
 Driver Class: Class 2
 Input Voltage (V): 120 - 277
 Constant Current (MA): 350
 Upon Request: (Not included - see components) Remote: 0-10Vdc dimming / Phase dimming @120Vac only

LED

Number of LEDs: 1
 Color Temperature (°K): 2700
 Max. Delivered Lumen (lm): 376
 CRI: >90 CRI
 Lamp Life (hrs): 50000

OPTICAL

RATINGS AND CERTIFICATIONS

Certified By: Certified for North American Standards
 IP rating: IP20

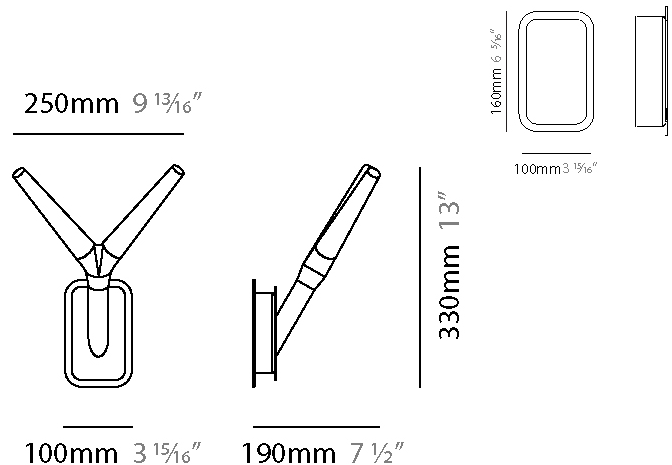

SPARKS DOUBLE HEAD SURFACE

D103134-

PROJECT

TYPE

SPECIFIER

QUANTITY

DATE

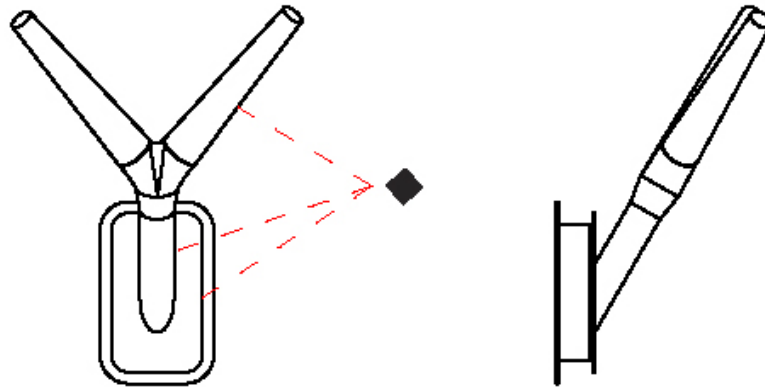

D

SPARKS TRIPLE HEAD SURFACE

D103136-

base number _____
 Finish _____
 Options _____

- To build a product code in our configurator select the specify button on the base model # product page
- To build a manual product code on this datasheet choose from the options listed below in blue font and add the suffix to the base model #

GENERAL

Series: Sparks _____
 Subseries: Sparks Triple Head _____
 Brand: Quasar _____
 Division: Design _____
 Mounting Type: Surface _____
 Mounting Location: Wall _____
 Subcategory: Ambient _____

PHYSICAL

Shape: Abstract _____
 Length (mm): 270 _____
 Length (in): 10 ⁵/₈ _____
 Height (mm): 340 _____
 Depth (mm): 290 _____
 Height (in): 13 ³/₈ _____
 Depth (in): 11 ¹/₁₆ _____
 Light Distribution: Omnidirectional _____
 Weight (kg): 3 _____
 Weight (lbs): 6.6 _____
 Fixture Finish: WHI / PAL _____
 Fixture Material: Metal _____

ELECTRICAL

Lamp Type: LED _____
 Input Wattage (W): 4.2 _____
 Total Output Wattage (W): 1.2 _____
 Dimming: Non-Dimmable _____
 Driver Included: Yes _____
 Driver Location: Integrated _____
 Driver Type: Constant Current - Universal _____
 Driver Class: Class 2 _____
 Input Voltage (V): 120 - 277 _____
 Constant Current (MA): 350 _____
 Upon Request: (Not included - see components) Remote: 0-10Vdc dimming / Phase dimming @120Vac only

LED

Number of LEDs: 1 _____
 Color Temperature (°K): 2700 _____
 Max. Delivered Lumen (lm): 376 _____
 CRI: >90 CRI _____
 Lamp Life (hrs): 50000 _____

OPTICAL

RATINGS AND CERTIFICATIONS

Certified By: Certified for North American Standards _____
 IP rating: IP20 _____



250mm 9 13/16"

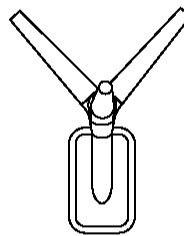

100mm 3 15/16"

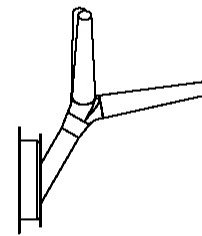

290mm 11 7/16"

340mm 13 3/8"

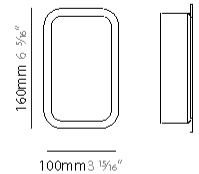

160mm 6 1/4"

100mm 3 15/16"



SPARKS TRIPLE HEAD SURFACE

D103136-

PROJECT	_____
TYPE	_____
SPECIFIER	_____
QUANTITY	_____
DATE	_____

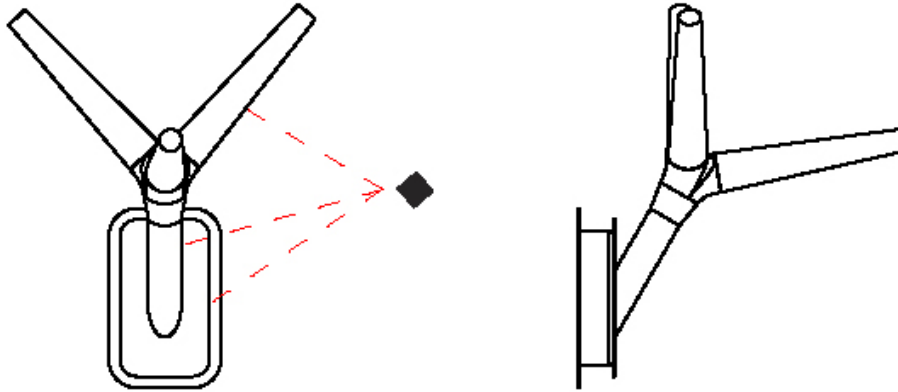

PROJECT	_____
TYPE	_____
SPECIFIER	_____
QUANTITY	_____
DATE	_____

SPARKS 7 SURFACE

D103142-

base number	LED Dimming	Finish Options
-------------	-------------	----------------

- To build a product code in our configurator select the specify button on the base model # product page
- To build a manual product code on this datasheet choose from the options listed below in blue font and add the suffix to the base model #

GENERAL

Series: Sparks
Subseries: Sparks 7
Brand: Quasar
Division: Design
Mounting Type: Surface
Mounting Location: Wall
Subcategory: Ambient

PHYSICAL

Shape: Abstract
Length (mm): 1100
Length (in): 43 ⁵ / ₁₆
Height (mm): 1800
Depth (mm): 900
Height (in): 70 ⁷ / ₈
Depth (in): 35 ⁷ / ₁₆
Light Distribution: Omnidirectional
Fixture Finish: WHI / PAL
Fixture Material: Metal

ELECTRICAL

Lamp Type: LED
Input Wattage (W): 32.2
Total Output Wattage (W): 22.4
Dimming: Non-Dimming / Phase Dimming (120Vac only) / 0-10V Dimming
Driver Included: Yes
Driver Location: Integrated
Driver Type: Constant Voltage - Universal
Driver Class: Class 2
Input Voltage (V): 120 - 277
Output Voltage (V): 24

LED

Number of LEDs: 7
Color Temperature (°K): 2700
Max. Delivered Lumen (lm): 2632
CRI: >90 CRI
Lamp Life (hrs): 50000

OPTICAL

RATINGS AND CERTIFICATIONS

Certified By: Certified for North American Standards
IP rating: IP20

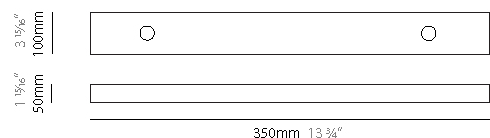
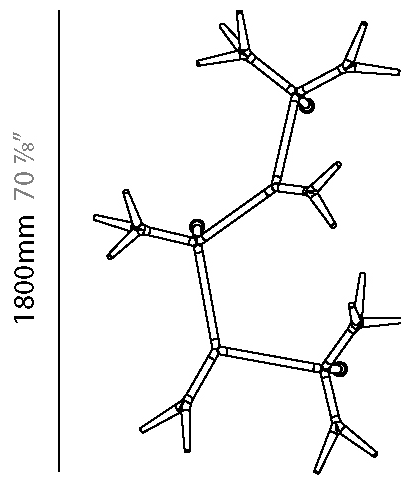
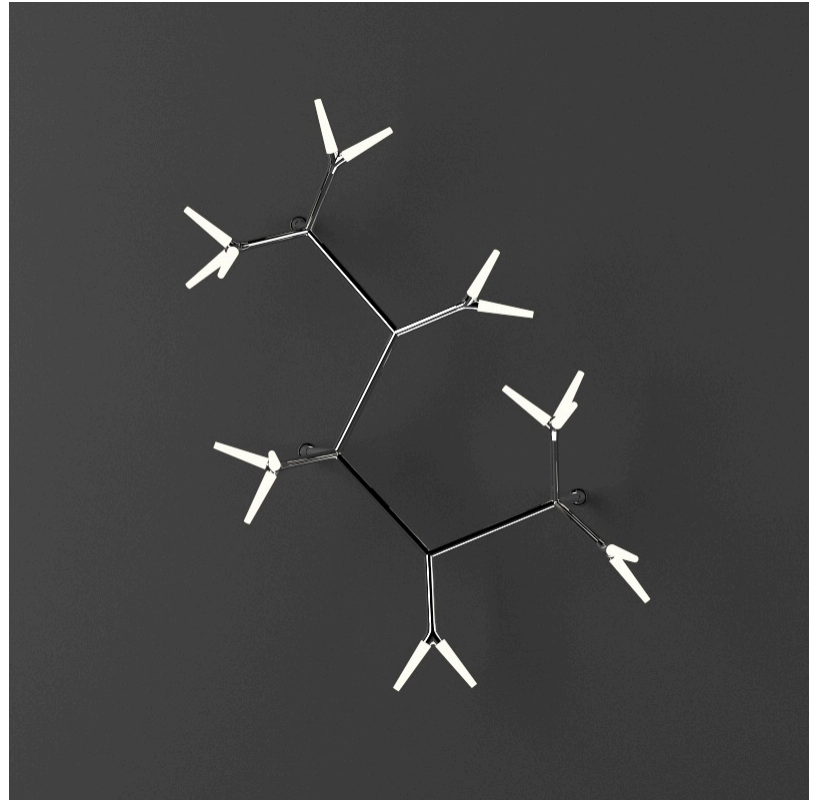

SPARKS 7 SURFACE

D103142-

PROJECT	_____
TYPE	_____
SPECIFIER	_____
QUANTITY	_____
DATE	_____

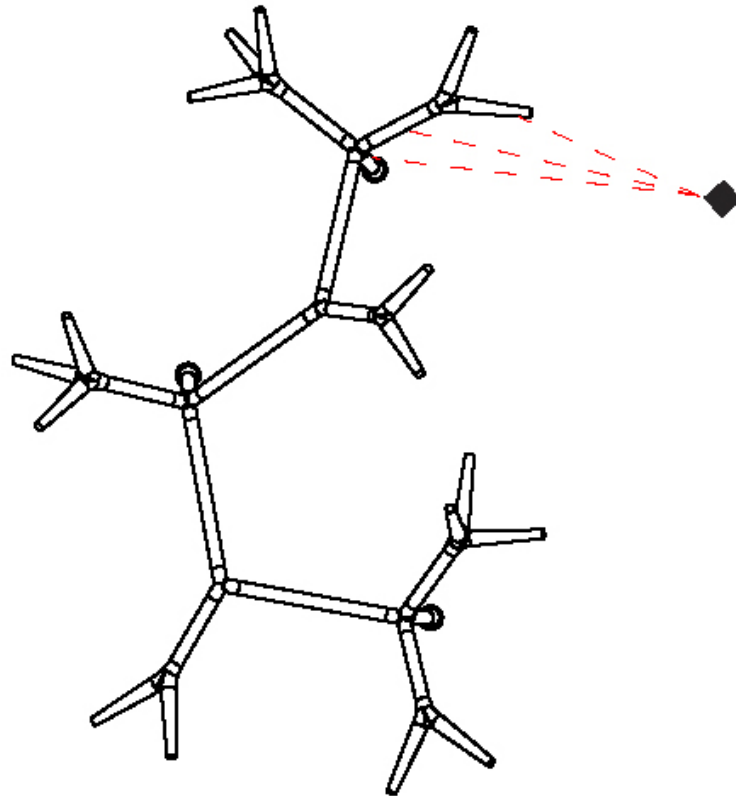

D

PROJECT	
TYPE	
SPECIFIER	
QUANTITY	
DATE	

SPARKS 9 SURFACE

D103143-

base number	LED Dimming	Finish Options
-------------	-------------	----------------

- To build a product code in our configurator select the specify button on the base model # product page
- To build a manual product code on this datasheet choose from the options listed below in blue font and add the suffix to the base model #

GENERAL

Series: Sparks
Subseries: Sparks 9
Brand: Quasar
Division: Design
Mounting Type: Surface
Mounting Location: Wall
Subcategory: Ambient

PHYSICAL

Shape: Abstract
Length (mm): 1200
Length (in): 47 1/4
Height (mm): 2400
Depth (mm): 900
Height (in): 94 1/2
Depth (in): 35 7/16
Light Distribution: Omnidirectional
Fixture Finish: WHI / PAL
Fixture Material: Metal

ELECTRICAL

Lamp Type: LED
Input Wattage (W): 41.4
Total Output Wattage (W): 28.8
Dimming: Non-Dimming / Phase Dimming (120Vac only) / 0-10V Dimming
Driver Included: Yes
Driver Location: Integrated
Driver Type: Constant Voltage - Universal
Driver Class: Class 2
Input Voltage (V): 120 - 277
Output Voltage (V): 24

LED

Number of LEDs: 9
Color Temperature (°K): 2700
Max. Delivered Lumen (lm): 3384
CRI: >90 CRI
Lamp Life (hrs): 50000

OPTICAL

RATINGS AND CERTIFICATIONS

Certified By: Certified for North American Standards
IP rating: IP20

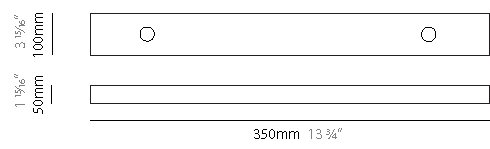
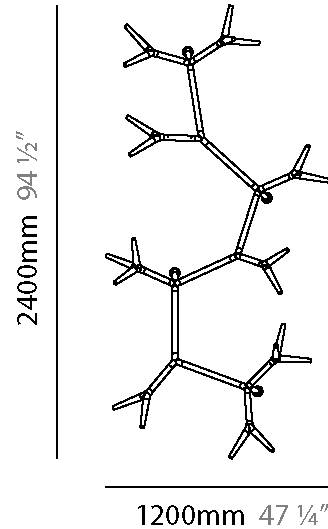
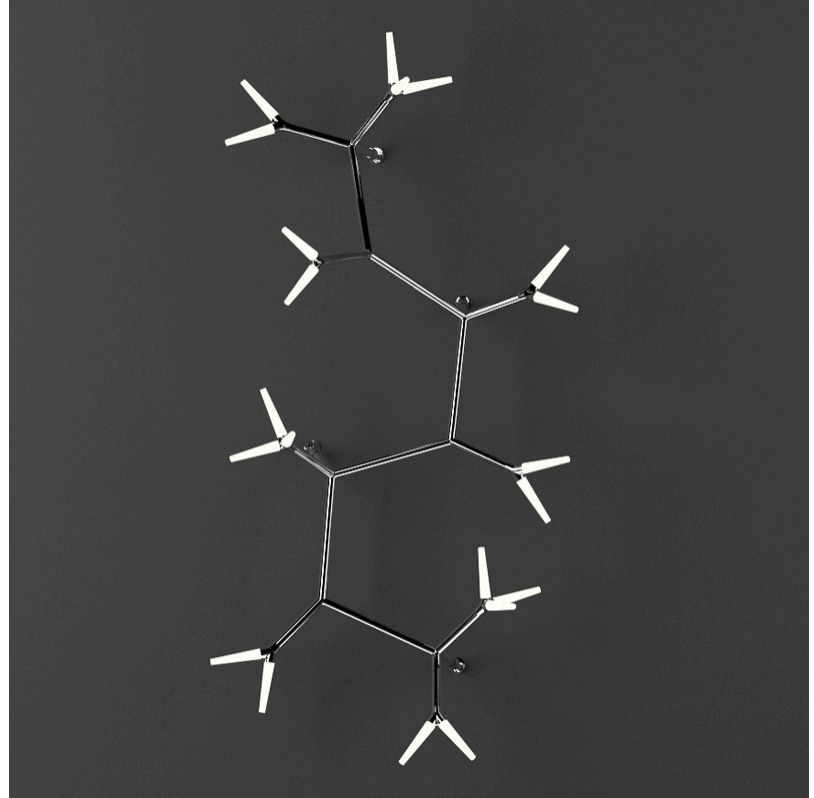

D103143-

PROJECT

TYPE

SPECIFIER

QUANTITY

DATE

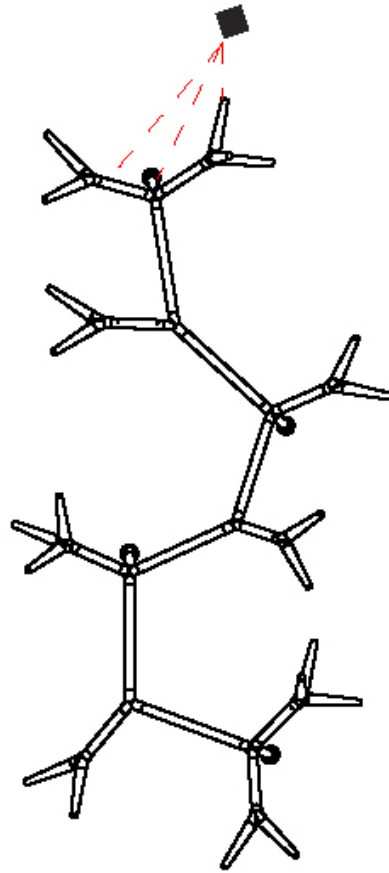

D

SPARKS 11 SURFACE

D103145-

base number LED Finish
 Dimming Options

- To build a product code in our configurator select the specify button on the base model # product page
- To build a manual product code on this datasheet choose from the options listed below in blue font and add the suffix to the base model #

GENERAL

Series: Sparks
 Subseries: Sparks 11
 Brand: Quasar
 Division: Design
 Mounting Type: Surface
 Mounting Location: Wall
 Subcategory: Ambient

PHYSICAL

Shape: Abstract
 Length (mm): 1700
 Length (in): 66 ¹⁵/₁₆
 Height (mm): 2600
 Depth (mm): 900
 Height (in): 102 ³/₈
 Depth (in): 35 ⁷/₁₆
 Light Distribution: Omnidirectional
 Fixture Finish: WHI / PAL
 Fixture Material: Metal

ELECTRICAL

Lamp Type: LED
 Input Wattage (W): 50.6
 Total Output Wattage (W): 35.2
 Dimming: Non-Dimming / Phase Dimming (120Vac only) / 0-10V Dimming
 Driver Included: Yes
 Driver Location: Integrated
 Driver Type: Constant Voltage - Universal
 Driver Class: Class 2
 Input Voltage (V): 120 - 277
 Output Voltage (V): 24

LED

Number of LEDs: 11
 Color Temperature (°K): 2700
 Max. Delivered Lumen (lm): 4136
 CRI: >90 CRI
 Lamp Life (hrs): 50000

OPTICAL

RATINGS AND CERTIFICATIONS

Certified By: Certified for North American Standards
 IP rating: IP20

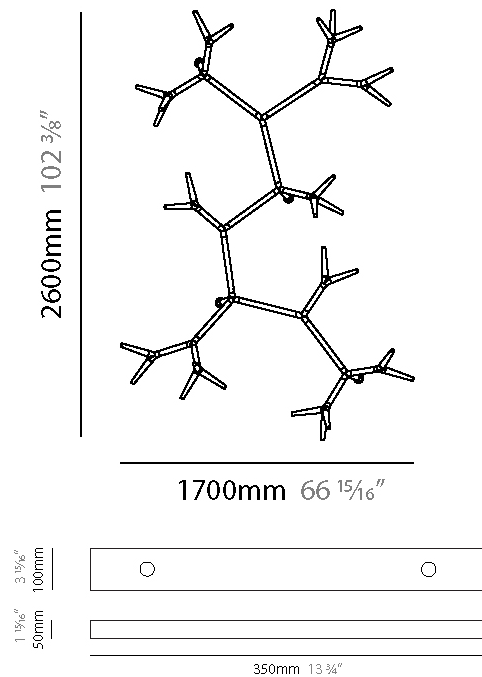
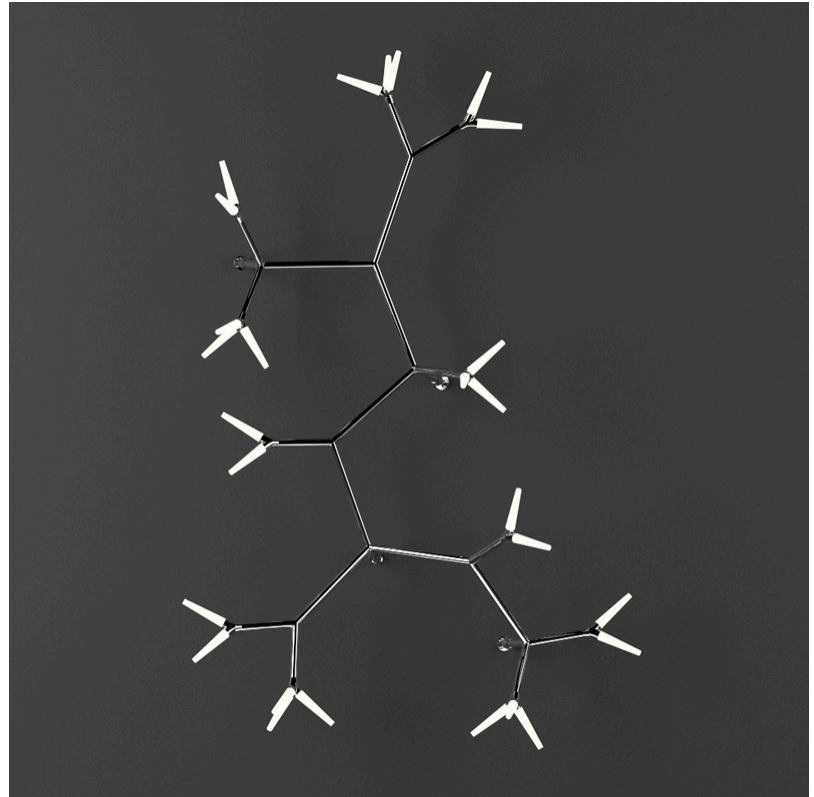

SPARKS 11 SURFACE

D103145-

PROJECT

TYPE

SPECIFIER

QUANTITY

DATE

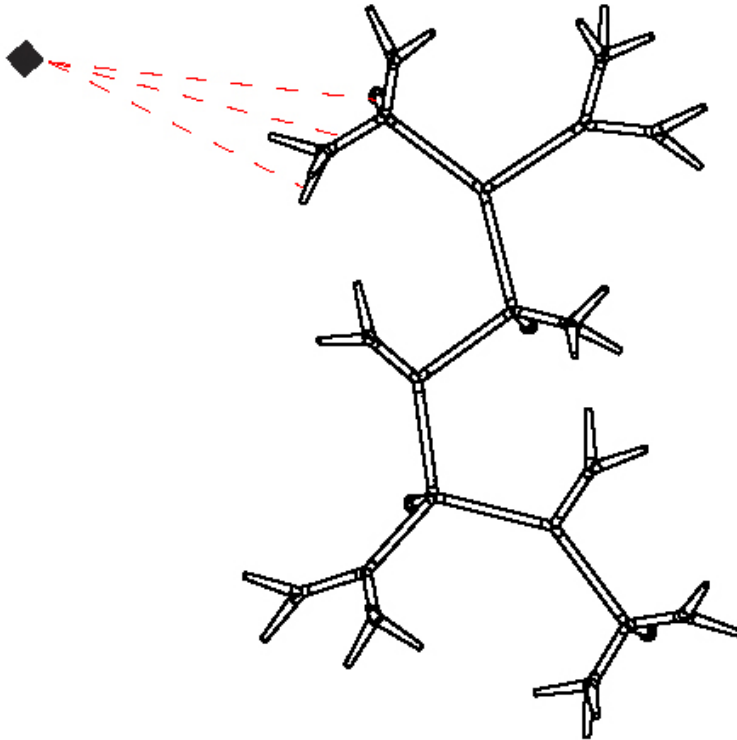

D

SPARKS 15 SURFACE

D103147-

base number LED Dimming Finish Options

- To build a product code in our configurator select the specify button on the base model # product page
- To build a manual product code on this datasheet choose from the options listed below in blue font and add the suffix to the base model #

GENERAL

Series: Sparks
 Subseries: Sparks 15
 Brand: Quasar
 Division: Design
 Mounting Type: Surface
 Mounting Location: Wall
 Subcategory: Ambient

PHYSICAL

Shape: Abstract
 Length (mm): 1900
 Length (in): 74 ¹³/₁₆
 Height (mm): 3340
 Depth (mm): 900
 Height (in): 131 ¹/₂
 Depth (in): 35 ⁷/₁₆
 Light Distribution: Omnidirectional
 Weight (kg): 17
 Weight (lbs): 37.48
 Fixture Finish: WHI / PAL
 Fixture Material: Metal

ELECTRICAL

Lamp Type: LED
 Input Wattage (W): 69
 Total Output Wattage (W): 48
 Dimming: Non-Dimming / Phase Dimming (120Vac only) / 0-10V Dimming
 Driver Included: Yes
 Driver Location: Integrated
 Driver Type: Constant Voltage - Universal
 Driver Class: Class 2
 Input Voltage (V): 120 - 277
 Output Voltage (V): 24

LED

Number of LEDs: 15
 Color Temperature (°K): 2700
 Max. Delivered Lumen (lm): 5640
 CRI: >90 CRI
 Lamp Life (hrs): 50000

OPTICAL

RATINGS AND CERTIFICATIONS

Certified By: Certified for North American Standards
 IP rating: IP20

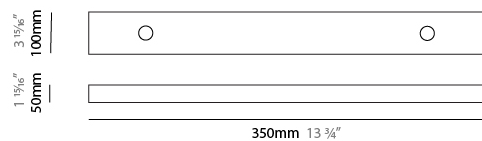
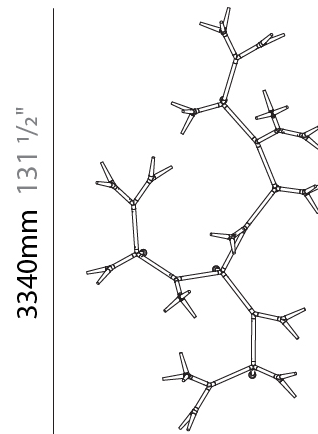
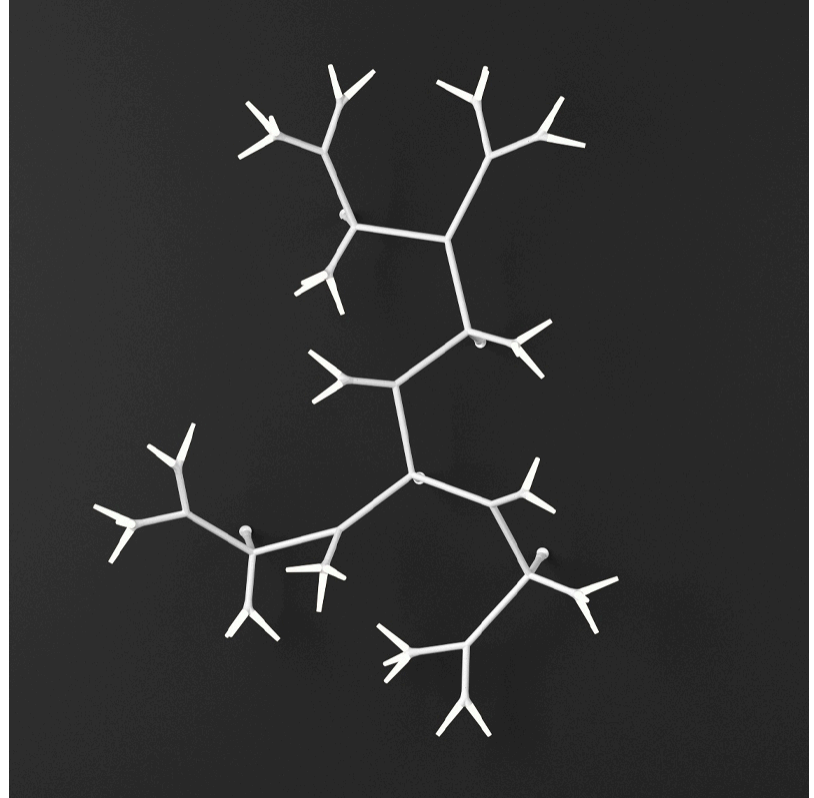

D103147-

PROJECT

TYPE

SPECIFIER

QUANTITY

DATE

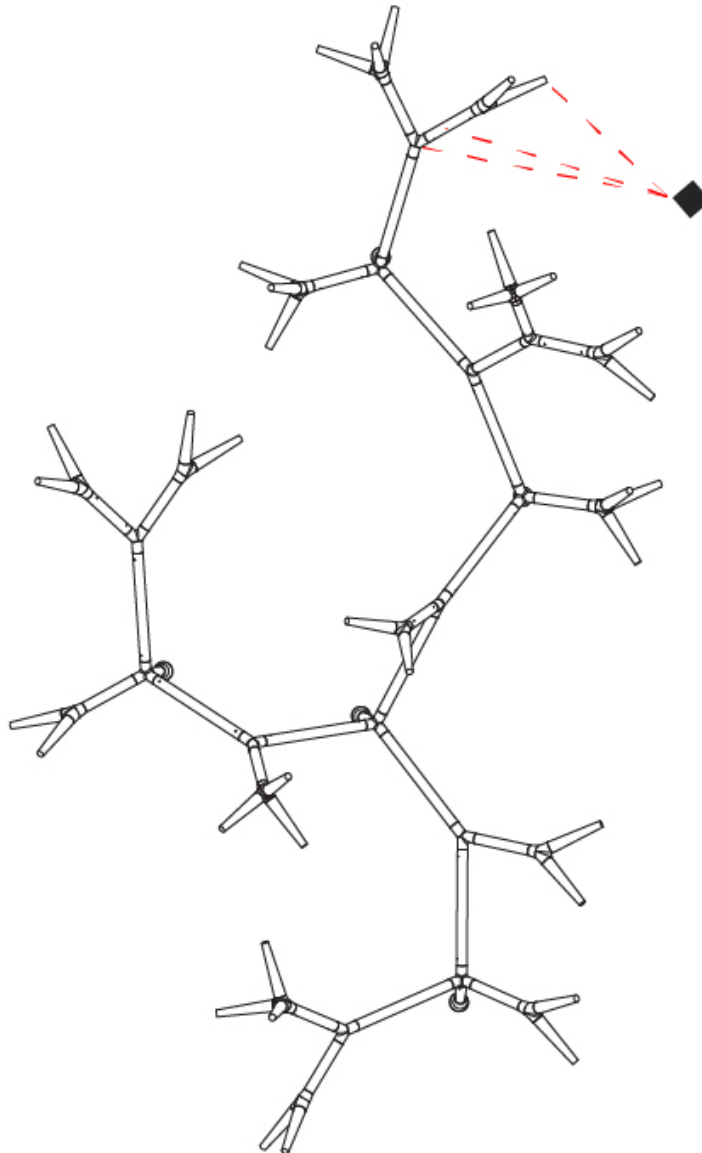

D

SPARKS 17 SURFACE

D103148-

base number LED Dimming Finish Options

- To build a product code in our configurator select the specify button on the base model # product page
- To build a manual product code on this datasheet choose from the options listed below in blue font and add the suffix to the base model #

GENERAL

Series: Sparks
 Subseries: Sparks 17
 Brand: Quasar
 Division: Design
 Mounting Type: Surface
 Mounting Location: Wall
 Subcategory: Ambient

PHYSICAL

Shape: Abstract
 Length (mm): 2590
 Length (in): 101 ¹⁵/₁₆
 Height (mm): 3250
 Depth (mm): 900
 Height (in): 127 ¹⁵/₁₆
 Depth (in): 35 ⁷/₁₆
 Light Distribution: Omnidirectional
 Weight (kg): 21
 Weight (lbs): 46.30
 Fixture Finish: WHI / PAL
 Fixture Material: Metal

ELECTRICAL

Lamp Type: LED
 Input Wattage (W): 78.2
 Total Output Wattage (W): 54.4
 Dimming: Non-Dimming / Phase Dimming (120Vac only) / 0-10V Dimming
 Driver Included: Yes
 Driver Location: Integrated
 Driver Type: Constant Voltage - Universal
 Driver Class: Class 2
 Input Voltage (V): 120 - 277
 Output Voltage (V): 24

LED

Number of LEDs: 17
 Color Temperature (°K): 2700
 Max. Delivered Lumen (lm): 6392
 CRI: >90 CRI
 Lamp Life (hrs): 50000

OPTICAL

RATINGS AND CERTIFICATIONS

Certified By: Certified for North American Standards
 IP rating: IP20

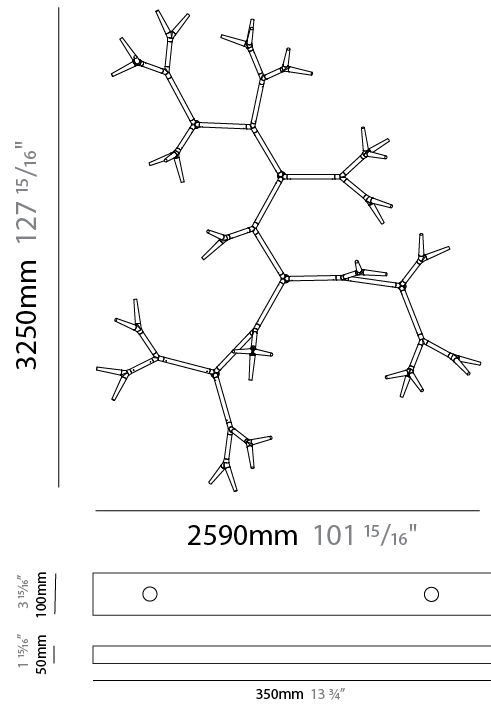
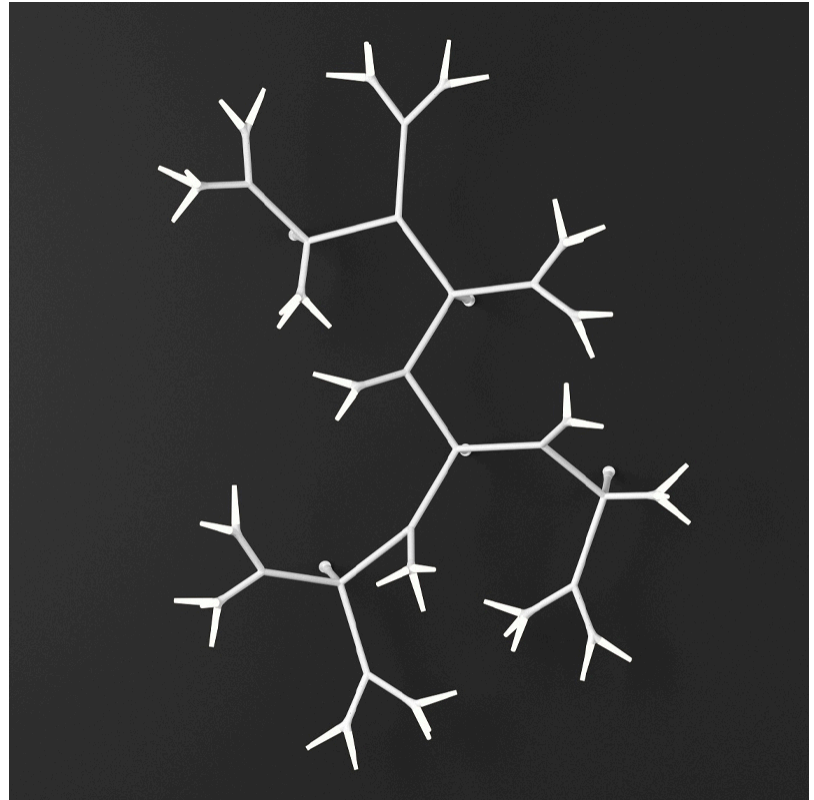

SPARKS 17 SURFACE

D103148-

PROJECT

TYPE

SPECIFIER

QUANTITY

DATE

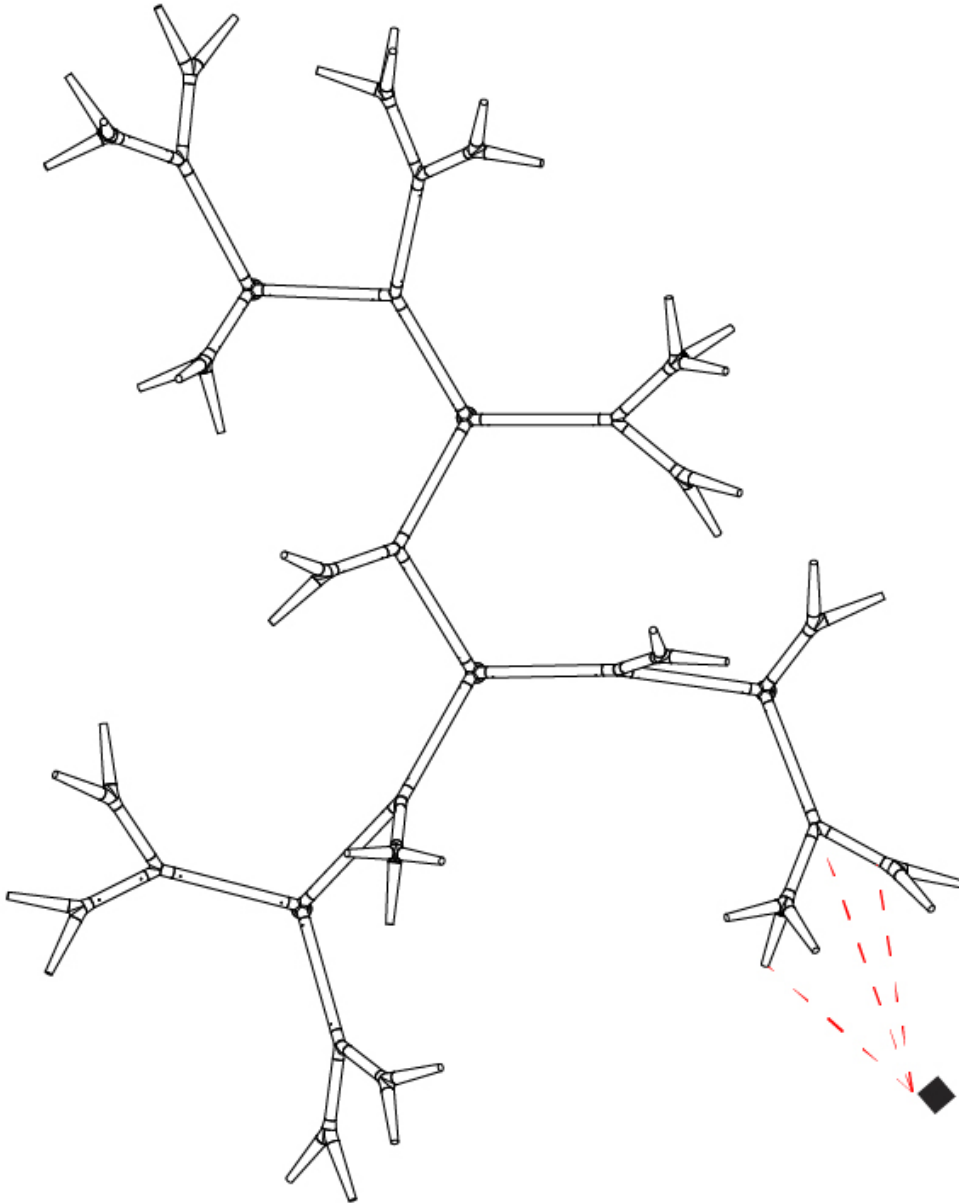

D

PROJECT	
TYPE	
SPECIFIER	
QUANTITY	
DATE	

SPARKS 19 SURFACE

D103149-

base number	LED Dimming	Finish Options
-------------	-------------	----------------

- To build a product code in our configurator select the specify button on the base model # product page
- To build a manual product code on this datasheet choose from the options listed below in blue font and add the suffix to the base model #

GENERAL

Series: Sparks
Subseries: Sparks 19
Brand: Quasar
Division: Design
Mounting Type: Surface
Mounting Location: Wall
Subcategory: Ambient

PHYSICAL

Shape: Abstract
Length (mm): 1880
Length (in): 74
Height (mm): 5300
Depth (mm): 900
Height (in): 208 ¹¹ / ₁₆
Depth (in): 35 ⁷ / ₁₆
Light Distribution: Omnidirectional
Weight (kg): 24
Weight (lbs): 52.91
Fixture Finish: WHI / PAL
Fixture Material: Metal

ELECTRICAL

Lamp Type: LED
Input Wattage (W): 87.4
Total Output Wattage (W): 60.8
Dimming: 0-10V Dimming / Phase Dimming (120Vac Only)
Driver Included: Yes
Driver Location: Integrated
Driver Type: Constant Voltage - Universal
Driver Class: Class 2
Input Voltage (V): 120 - 277
Output Voltage (V): 24

LED

Number of LEDs: 19
Color Temperature (°K): 2700
Max. Delivered Lumen (lm): 7144
CRI: >90 CRI
Lamp Life (hrs): 50000

OPTICAL

RATINGS AND CERTIFICATIONS

Certified By: Certified for North American Standards
IP rating: IP20

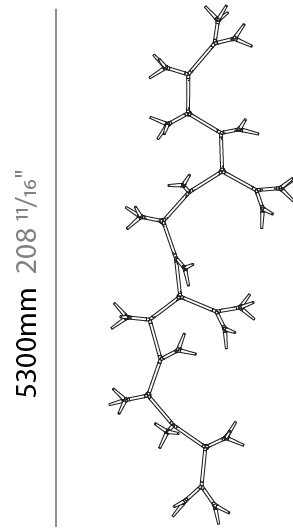
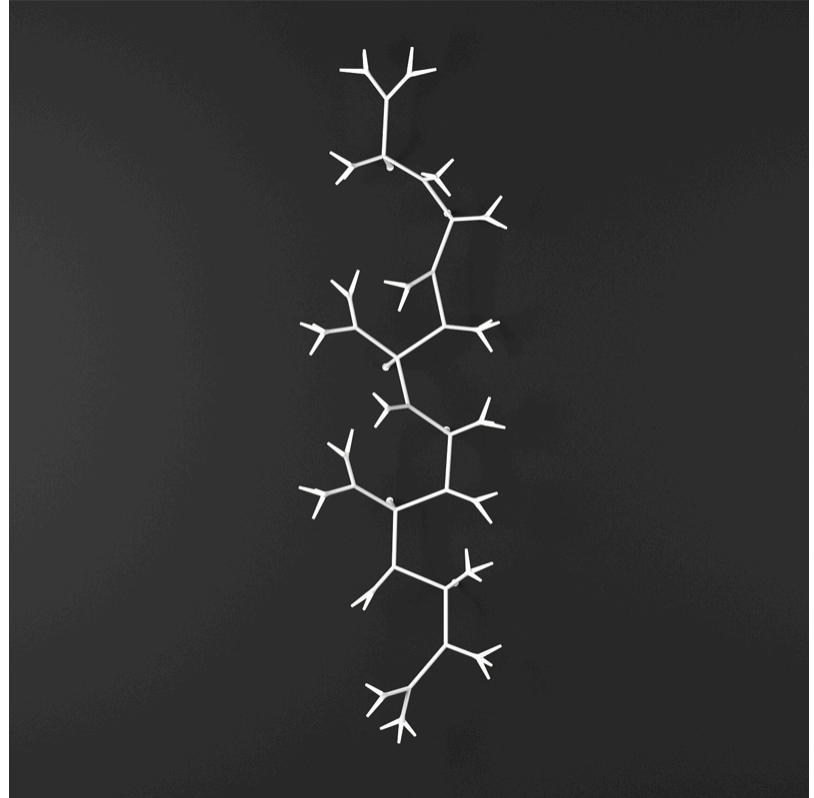

1880mm 74"

1 15/16"
50mm
3 13/16"
100mm

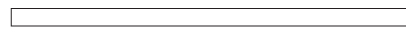

350mm 13 3/4"



SPARKS 19 SURFACE

D103149-

PROJECT

TYPE

SPECIFIER

QUANTITY

DATE

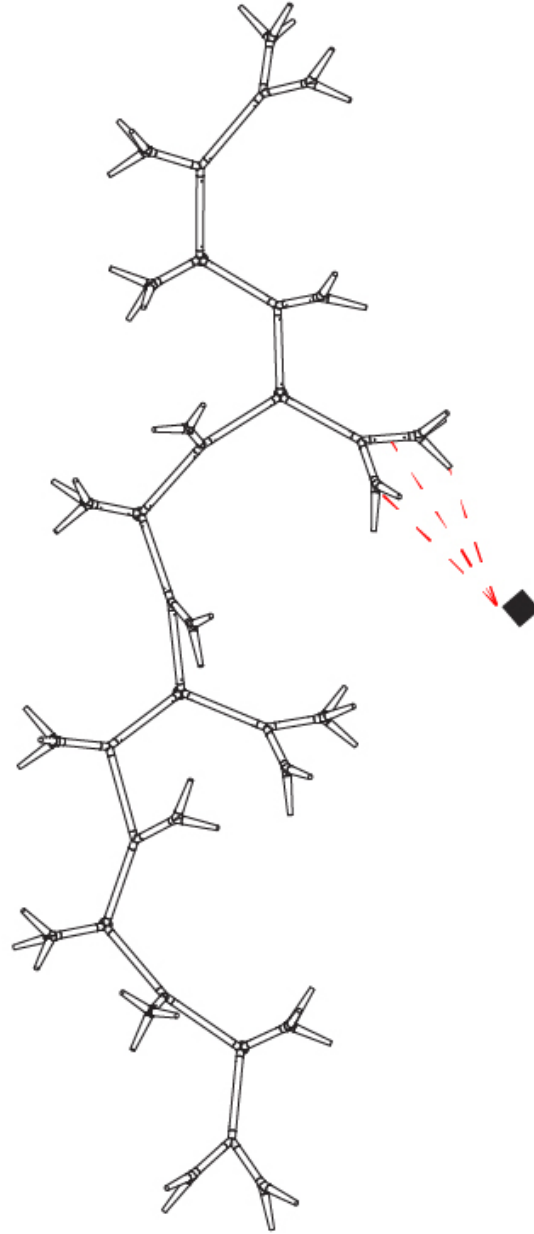

D

SPARKS

COLOR FINISH CHART

PROJECT

TYPE

SPECIFIER

QUANTITY

DATE

Fixture Finish

White - WHI



Polished Alumimum - PAL

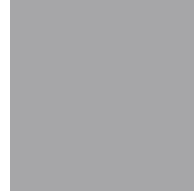

Digital: Not all screens are calibrated the same, and therefore, colors will appear differently between screens.











Physical: When texture is involved, there will be variations in color, character and tone within a product series and between product families.



LEGEND

	floor-mounted		pivotal		special LED (upon request) RGB, RGBW, tunable, gold+, meat+, art+, fashion+
	wall and ceiling: recessed and surface mounted		rotating		warm dim / natural dimming LED
	ceiling-mounted and wall-mounted		illuminate tilted		rechargeable battery powered
	wall-mounted		color of suspension cable		fixture with natural vivid LED (upon request)
	omni-directional light distribution		length of suspension cable		color rendering index
	direct light distribution		reflector degree selection		color temperature
	direct/indirect light distribution		super spot		lumen (luminous flux)
	indirect light distribution		lens		efficacy (lumens per watt)
	asymmetric light distribution		lens pack		Unified Glare Rating (UGR) range from 5-40
	aura light distribution		shine ring		marine grade (AISI 316 stainless steel)
	round wall or ceiling cut-out		integrated shine ring with diffuser		walk on
	square wall or ceiling cut-out		free individual colors 01-29		drive on
	the supplied jig specifies the cutout dimensions		individual colors: 00 (free of charge), 01-25 (extra charge)		Dark Sky Compliance
	minimum distance (meters) lamp - object		luminaire part to be colored (F1)		Americans with Disabilities Act (less than 4" off the wall located between 27"-84" from floor)
	recessed depth		luminaire part to be colored (F2)		lamp protected against explosion
	ceiling thickness in mm		luminaire part to be colored (F3)		blown glass using traditional methods by master glass blower
	ceiling thickness selection		luminaire part to be colored (F4)		acoustic material
	dimnable DP (phase), DV (0-10V), DD (dali), DS (step-dim)		luminaire part to be colored (F5)		protection class I, protection insulation
	included or excluded LED driver/transformer/control gear		color of 3-circuit adaptor		protection class II, protection insulation
	separately switchable		indirect diffuser		ETL Certified to UL and CSA Standards
	sensor		direct diffuser		UL Certified to UL and CSA Standards
	remote control		ball-proof (upon request)		CSA Certified to UL and CSA Standards
	available upon request		accessory		Certified for North American Standards

IP RATING

	protected against ingress of solid bodies greater than 12.5mm (finger)
	protected against ingress of solid bodies greater than 2.5mm protected against sprays of water up to 60 degrees from the vertical (rain)
	protected against ingress of solid bodies greater than 1mm (wire) no protection against the ingress of moisture
	protected against ingress of solid bodies greater than 1mm (wire) protected against sprays of water up to 60 degrees from the vertical (rain)
	protected against ingress of solid bodies greater than 1mm (wire) protected against water splashed from all directions
	protected against limited ingress of dust (wet rooms/covered outdoor areas) protected against water splashed from all directions
	protected against ingress of dust protected against jets of water
	protected against ingress of dust protected against powerful jets of water or heavy seas
	protected against ingress of dust protected against immersion of water between 15cm - 1m for 30 minutes
	protected against ingress of dust protected against immersion of water under pressure for long periods

IK RATING

	protected against 0.14 joules impact (equivalent to 0.25kg mass dropped from 56mm above the surface)
	protected against 0.2 joules impact (equivalent to 0.25kg mass dropped from 80mm above the surface)
	protected against 0.35 joules impact (equivalent to 0.25kg mass dropped from 140mm above the surface)
	protected against 0.5 joules impact (equivalent to 0.25kg mass dropped from 200mm above the surface)
	protected against 0.7 joules impact (equivalent to 0.25kg mass dropped from 280mm above the surface)
	protected against 1 joules impact (equivalent to 0.25kg mass dropped from 400mm above the surface)
	protected against 2 joules impact (equivalent to 0.5kg mass dropped from 400mm above the surface)
	protected against 5 joules impact (equivalent to 1.7kg mass dropped from 300mm above the surface)
	protected against 10 joules impact (equivalent to 5.0kg mass dropped from 200mm above the surface)
	protected against 20 joules impact (equivalent to 5.0kg mass dropped from 400mm above the surface)