

SPARKS 3 SUSPENSION

D101686-

base number LED Dimming Finish Options

- To build a product code in our configurator select the specify button on the base model # product page
- To build a manual product code on this datasheet choose from the options listed below in blue font and add the suffix to the base model #

GENERAL

Series: Sparks
 Subseries: Sparks 3
 Brand: Quasar
 Division: Design
 Mounting Type: Suspension
 Mounting Location: Ceiling
 Subcategory: Ambient

PHYSICAL

Shape: Abstract
 Diameter (mm): 780
 Diameter (in): 30 ¹¹/₁₆
 Height (mm): 520
 Height (in): 20 ¹/₂
 Max. Overall Height (mm): 2520
 Max. Overall Height (in): 99 ³/₁₆
 Light Distribution: Omnidirectional
 Weight (kg): 5
 Weight (lbs): 11.02
[Fixture Finish: WHI / PAL](#)
 Fixture Material: Metal
 Cable Details: 2000mm Cable

ELECTRICAL

Lamp Type: LED
 Input Wattage (W): 13.8
 Total Output Wattage (W): 9.6
[Dimming: Non-Dimming / Phase Dimming \(120vac Only\)](#)
 Driver Included: Yes
 Driver Location: Integrated
 Driver Type: Constant Voltage - Universal
 Driver Class: Class 2
 Input Voltage (V): 120 - 277
 Output Voltage (V): 24
 Upon Request: (Not included - see components) Remote: 0-10Vdc dimming

LED

Number of LEDs: 3
 Color Temperature (°K): 2700
 Max. Delivered Lumen (lm): 1128
 CRI: >90 CRI
 Lamp Life (hrs): 50000

OPTICAL

RATINGS AND CERTIFICATIONS

Certified By: Certified for North American Standards
 IP rating: IP20

PROJECT	_____
TYPE	_____
SPECIFIER	_____
QUANTITY	_____
DATE	_____

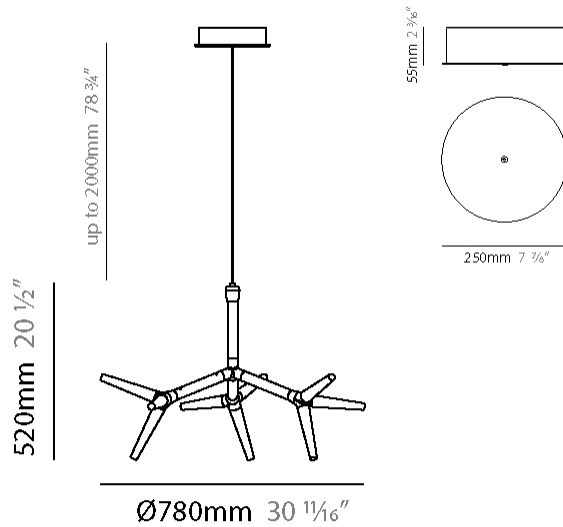
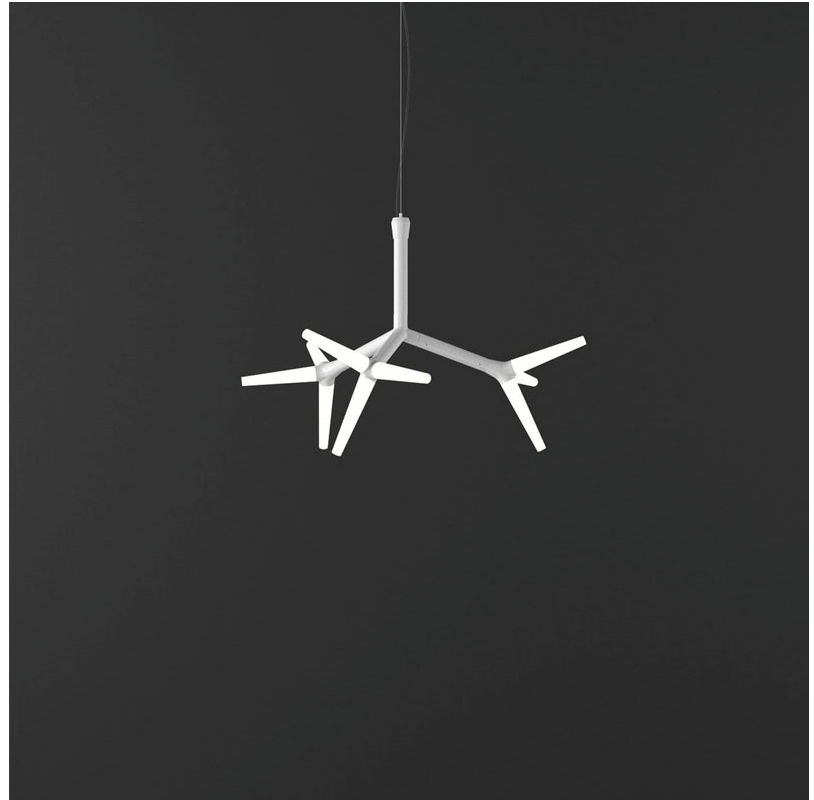

SPARKS 3 SUSPENSION

D101686-

PROJECT

TYPE

SPECIFIER

QUANTITY

DATE

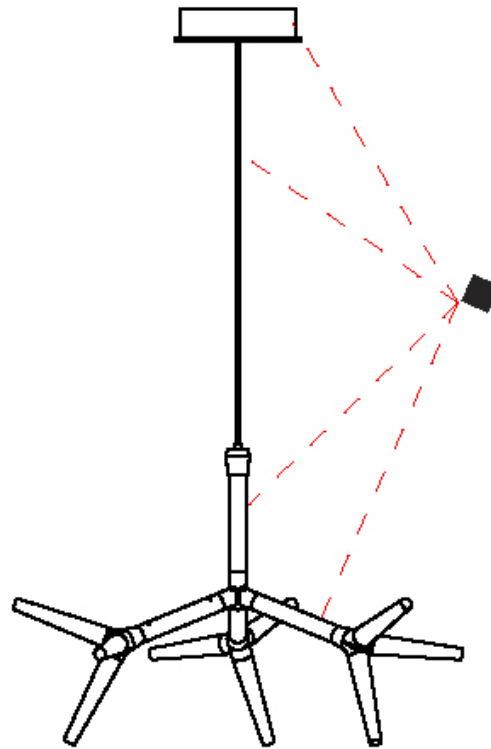

D

PROJECT	
TYPE	
SPECIFIER	
QUANTITY	
DATE	

SPARKS 6 SUSPENSION

D101688-

base number LED Dimming Finish Options

- To build a product code in our configurator select the specify button on the base model # product page
- To build a manual product code on this datasheet choose from the options listed below in blue font and add the suffix to the base model #

GENERAL

Series: Sparks
 Subseries: Sparks 6
 Brand: Quasar
 Division: Design
 Mounting Type: Suspension
 Mounting Location: Ceiling
 Subcategory: Ambient

PHYSICAL

Shape: Abstract
 Length (mm): 1300
 Length (in): 51 ³/₁₆"
 Width (mm): 730
 Width (in): 28 ³/₄"
 Height (mm): 980
 Height (in): 38 ⁹/₁₆"
 Max. Overall Height (mm): 2980
 Max. Overall Height (in): 117 ⁵/₁₆"
 Light Distribution: Omnidirectional
 Weight (kg): 7
 Weight (lbs): 15.43
 Fixture Finish: WHI / PAL
 Fixture Material: Metal
 Cable Details: 2000mm Cable

ELECTRICAL

Lamp Type: LED
 Input Wattage (W): 27.6
 Total Output Wattage (W): 19.2
 Dimming: Non-Dimming / Phase Dimming (120vac Only)
 Driver Included: Yes
 Driver Location: Integrated
 Driver Type: Constant Voltage - Universal
 Driver Class: Class 2
 Input Voltage (V): 120 - 277
 Output Voltage (V): 24
 Upon Request: (Not included - see components) Remote: 0-10Vdc dimming

LED

Number of LEDs: 6
 Color Temperature (°K): 2700
 Max. Delivered Lumen (lm): 2256
 CRI: >90 CRI
 Lamp Life (hrs): 50000

OPTICAL

RATINGS AND CERTIFICATIONS

Certified By: Certified for North American Standards
 IP rating: IP20

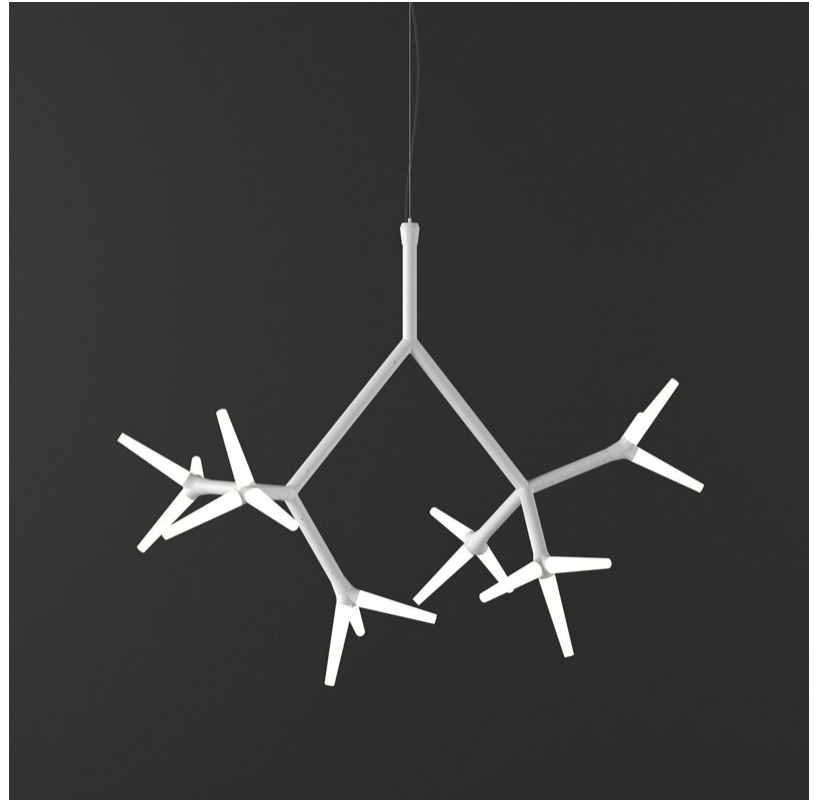

SPARKS 6 SUSPENSION

D101688-

PROJECT

TYPE

SPECIFIER

QUANTITY

DATE

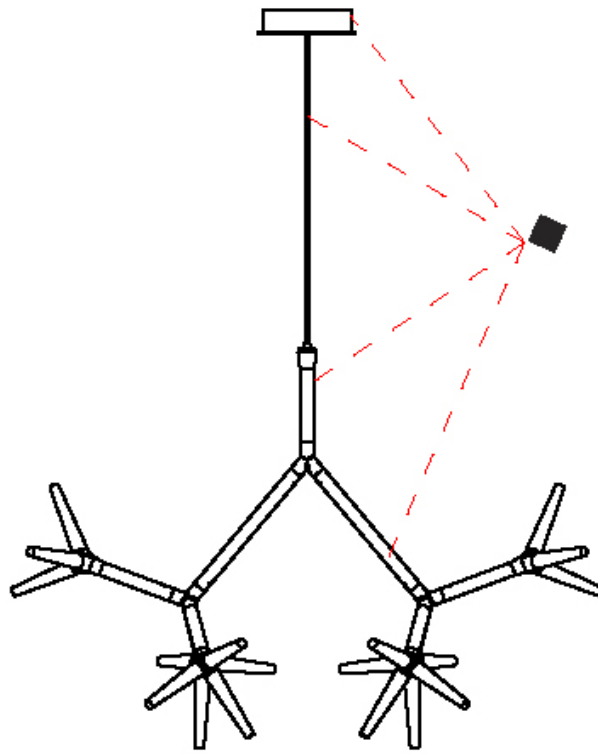

D

PROJECT	_____
TYPE	_____
SPECIFIER	_____
QUANTITY	_____
DATE	_____

SPARKS 9 SUSPENSION

D101690-

base number	LED	Finish
	Dimming	Options

- To build a product code in our configurator select the specify button on the base model # product page
- To build a manual product code on this datasheet choose from the options listed below in blue font and add the suffix to the base model #

GENERAL

Series: Sparks
Subseries: Sparks 9
Brand: Quasar
Division: Design
Mounting Type: Suspension
Mounting Location: Ceiling
Subcategory: Ambient

PHYSICAL

Shape: Abstract
Diameter (mm): 1370
Diameter (in): 53 ¹⁵ / ₁₆
Height (mm): 800
Height (in): 31 ¹ / ₂
Max. Overall Height (mm): 2800
Max. Overall Height (in): 110 ¹ / ₄
Light Distribution: Omnidirectional
Weight (kg): 10
Weight (lbs): 22.05
Fixture Finish: WHI / PAL
Fixture Material: Metal
Cable Details: 2000mm Cable

ELECTRICAL

Lamp Type: LED
Input Wattage (W): 41.4
Total Output Wattage (W): 28.8
Dimming: Non-Dimming / Phase Dimming (120vac Only)
Driver Included: Yes
Driver Location: Integrated
Driver Type: Constant Voltage - Universal
Driver Class: Class 2
Input Voltage (V): 120 - 277
Output Voltage (V): 24
Upon Request: (Not included - see components) Remote: 0-10Vdc dimming

LED

Number of LEDs: 9
Color Temperature (°K): 2700
Max. Delivered Lumen (lm): 3384
CRI: >90 CRI
Lamp Life (hrs): 50000

OPTICAL

RATINGS AND CERTIFICATIONS

Certified By: Certified for North American Standards
IP rating: IP20



SPARKS 9 SUSPENSION

D101690-

PROJECT	_____
TYPE	_____
SPECIFIER	_____
QUANTITY	_____
DATE	_____

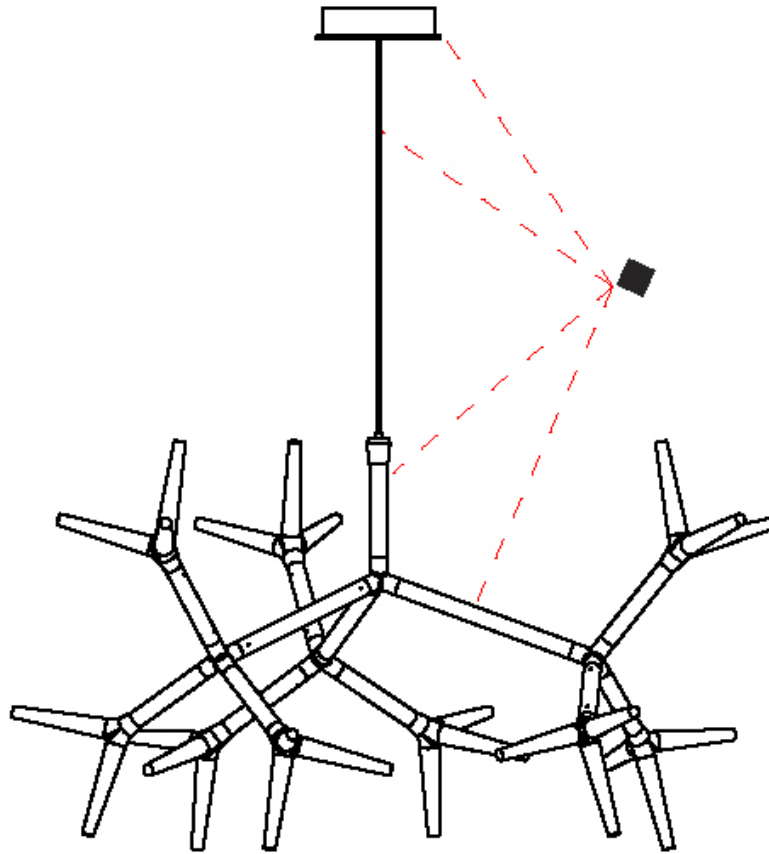

D

PROJECT	
TYPE	
SPECIFIER	
QUANTITY	
DATE	

SPARKS 6 SUSPENSION

D101692-

base number LED Dimming - Finish Options

- To build a product code in our configurator select the specify button on the base model # product page
- To build a manual product code on this datasheet choose from the options listed below in blue font and add the suffix to the base model #

GENERAL

Series: Sparks
 Subseries: Sparks 6
 Brand: Quasar
 Division: Design
 Mounting Type: Suspension
 Mounting Location: Ceiling
 Subcategory: Ambient

PHYSICAL

Shape: Abstract
 Length (mm): 1900
 Length (in): 74 ¹³/₁₆
 Width (mm): 870
 Width (in): 34 ¹/₄
 Height (mm): 860
 Height (in): 33 ⁷/₈
 Max. Overall Height (mm): 2860
 Max. Overall Height (in): 112 ⁵/₈
 Light Distribution: Omnidirectional
 Weight (kg): 7
 Weight (lbs): 15.43
 Fixture Finish: WHI / PAL
 Fixture Material: Metal
 Cable Details: 2000mm Cable

ELECTRICAL

Lamp Type: LED
 Input Wattage (W): 27.6
 Total Output Wattage (W): 19.2
 Dimming: [Non-Dimming / Phase Dimming \(120Vac only\) / 0-10V Dimming](#)
 Driver Included: Yes
 Driver Location: Integrated
 Driver Type: Constant Voltage - Universal
 Driver Class: Class 2
 Input Voltage (V): 120 - 277
 Output Voltage (V): 24

LED

Number of LEDs: 6
 Color Temperature (°K): 2700
 Max. Delivered Lumen (lm): 2256
 CRI: >90 CRI
 Lamp Life (hrs): 50000

OPTICAL

RATINGS AND CERTIFICATIONS

Certified By: Certified for North American Standards
 IP rating: IP20

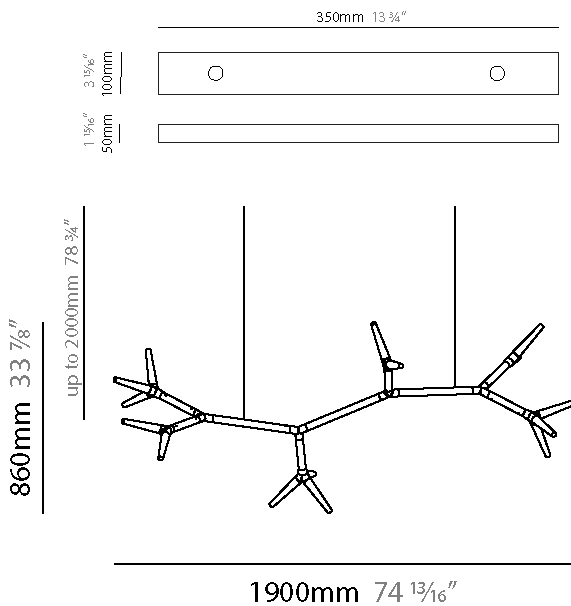

D101692-

PROJECT

TYPE

SPECIFIER

QUANTITY

DATE

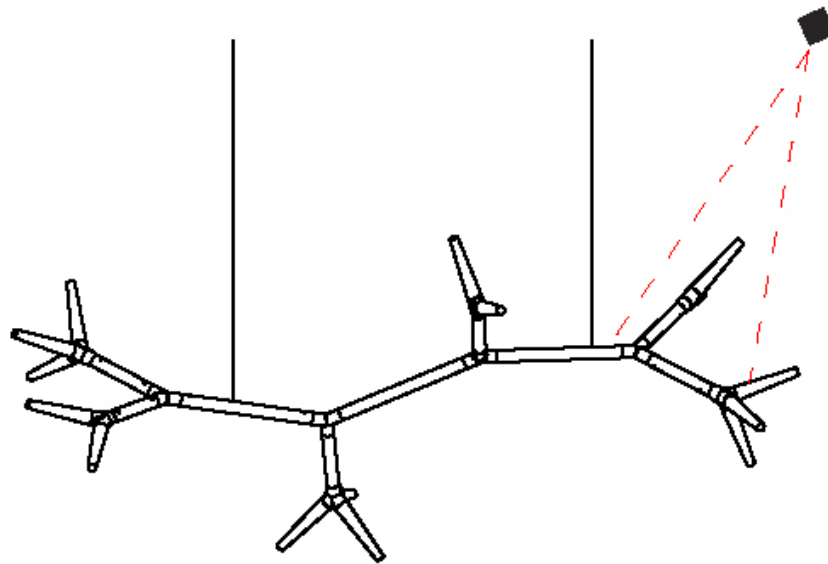

D

SPARKS 10 SUSPENSION

D101720-

base number LED Dimming - Finish Options

- To build a product code in our configurator select the specify button on the base model # product page
- To build a manual product code on this datasheet choose from the options listed below in blue font and add the suffix to the base model #

GENERAL

Series: Sparks
 Subseries: Sparks 10
 Brand: Quasar
 Division: Design
 Mounting Type: Suspension
 Mounting Location: Ceiling
 Subcategory: Ambient

PHYSICAL

Shape: Abstract
 Length (mm): 3000
 Length (in): 118 1/8
 Width (mm): 1000
 Width (in): 39 5/8
 Height (mm): 800
 Height (in): 31 1/2
 Max. Overall Height (mm): 2800
 Max. Overall Height (in): 110 1/4
 Light Distribution: Omnidirectional
 Weight (kg): 10
 Weight (lbs): 22.05
 Fixture Finish: WHI / PAL
 Fixture Material: Metal
 Cable Details: 2000mm Cable

ELECTRICAL

Lamp Type: LED
 Input Wattage (W): 46
 Dimming: Non-Dimming / Phase Dimming (120Vac only) / 0-10V Dimming
 Driver Included: Yes
 Driver Location: Integrated
 Driver Type: Constant Voltage - Universal
 Driver Class: Class 2
 Input Voltage (V): 120 - 277
 Output Voltage (V): 24

LED

Number of LEDs: 10
 Color Temperature (°K): 2700
 Max. Delivered Lumen (lm): 3760
 CRI: >90 CRI
 Lamp Life (hrs): 50000

OPTICAL

RATINGS AND CERTIFICATIONS

Certified By: Certified for North American Standards
 IP rating: IP20

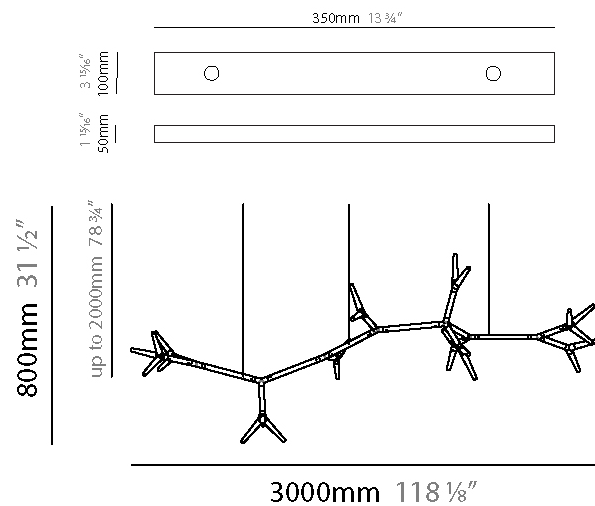

SPARKS 10 SUSPENSION

D101720-

PROJECT

TYPE

SPECIFIER

QUANTITY

DATE



PROJECT	
TYPE	
SPECIFIER	
QUANTITY	
DATE	

SPARKS DOUBLE HEAD SURFACE

D103134-

base number Finish
Options

- To build a product code in our configurator select the specify button on the base model # product page
- To build a manual product code on this datasheet choose from the options listed below in blue font and add the suffix to the base model #

GENERAL

Series: Sparks
Subseries: Sparks Double Head
Brand: Quasar
Division: Design
Mounting Type: Surface
Mounting Location: Wall
Subcategory: Ambient

PHYSICAL

Shape: Abstract
Length (mm): 225
Length (in): 8 7/8
Height (mm): 330
Depth (mm): 190
Height (in): 13
Depth (in): 7 1/2
Light Distribution: Omnidirectional
Weight (kg): 3
Weight (lbs): 6.6
[Fixture Finish: WHI / PAL](#)
Fixture Material: Metal

ELECTRICAL

Lamp Type: LED
Input Wattage (W): 4.2
Total Output Wattage (W): 3.2
Dimming: Non-Dimmable
Driver Included: Yes
Driver Location: Integrated
Driver Type: Constant Current - Universal
Driver Class: Class 2
Input Voltage (V): 120 - 277
Constant Current (MA): 350
Upon Request: (Not included - see components) Remote: 0-10Vdc dimming / Phase dimming @120Vac only

LED

Number of LEDs: 1
Color Temperature (°K): 2700
Max. Delivered Lumen (lm): 376
CRI: >90 CRI
Lamp Life (hrs): 50000

OPTICAL

RATINGS AND CERTIFICATIONS

Certified By: Certified for North American Standards
IP rating: IP20

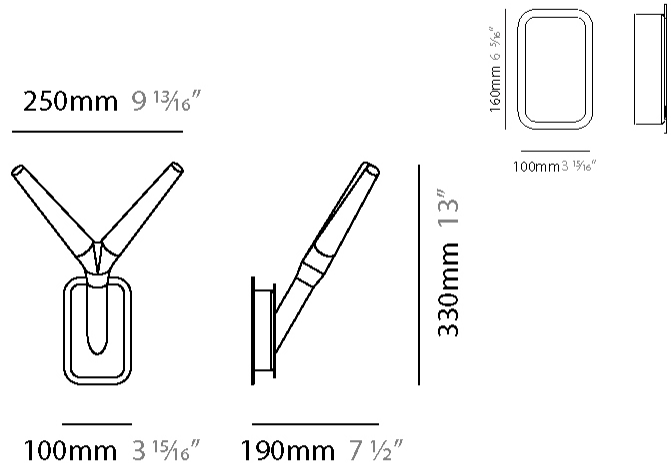

SPARKS DOUBLE HEAD SURFACE

D103134-

PROJECT _____

TYPE _____

SPECIFIER _____

QUANTITY _____

DATE _____

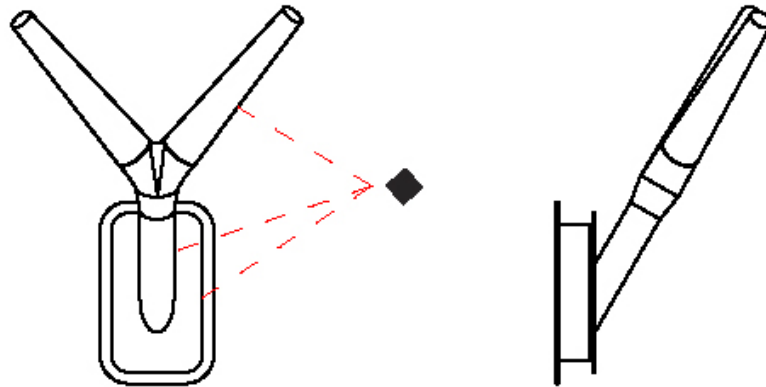

PROJECT	_____
TYPE	_____
SPECIFIER	_____
QUANTITY	_____
DATE	_____

SPARKS TRIPLE HEAD SURFACE

D103136-

base number Finish
Options

- To build a product code in our configurator select the specify button on the base model # product page
- To build a manual product code on this datasheet choose from the options listed below in blue font and add the suffix to the base model #

GENERAL

Series: Sparks
 Subseries: Sparks Triple Head
 Brand: Quasar
 Division: Design
 Mounting Type: Surface
 Mounting Location: Wall
 Subcategory: Ambient

PHYSICAL

Shape: Abstract
 Length (mm): 270
 Length (in): 10 ⁵/₈
 Height (mm): 340
 Depth (mm): 290
 Height (in): 13 ³/₈
 Depth (in): 11 ¹/₁₆
 Light Distribution: Omnidirectional
 Weight (kg): 3
 Weight (lbs): 6.6
 Fixture Finish: WHI / PAL
 Fixture Material: Metal

ELECTRICAL

Lamp Type: LED
 Input Wattage (W): 4.2
 Total Output Wattage (W): 1.2
 Dimming: Non-Dimmable
 Driver Included: Yes
 Driver Location: Integrated
 Driver Type: Constant Current - Universal
 Driver Class: Class 2
 Input Voltage (V): 120 - 277
 Constant Current (MA): 350
 Upon Request: (Not included - see components) Remote: 0-10Vdc dimming / Phase dimming @120Vac only

LED

Number of LEDs: 1
 Color Temperature (°K): 2700
 Max. Delivered Lumen (lm): 376
 CRI: >90 CRI
 Lamp Life (hrs): 50000

OPTICAL

RATINGS AND CERTIFICATIONS

Certified By: Certified for North American Standards
 IP rating: IP20

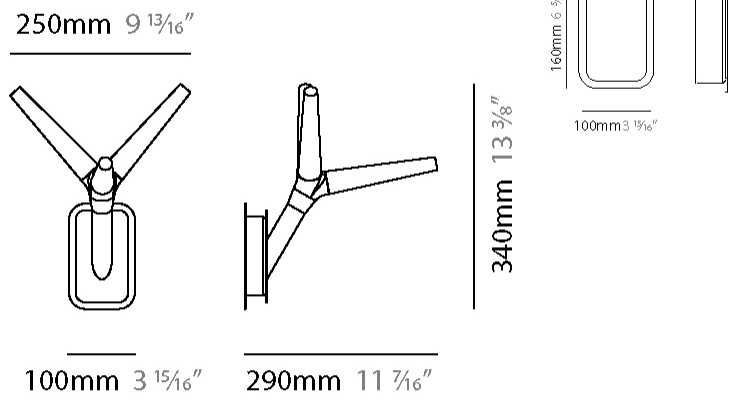

SPARKS TRIPLE HEAD SURFACE

D103136-

PROJECT _____

TYPE _____

SPECIFIER _____

QUANTITY _____

DATE _____

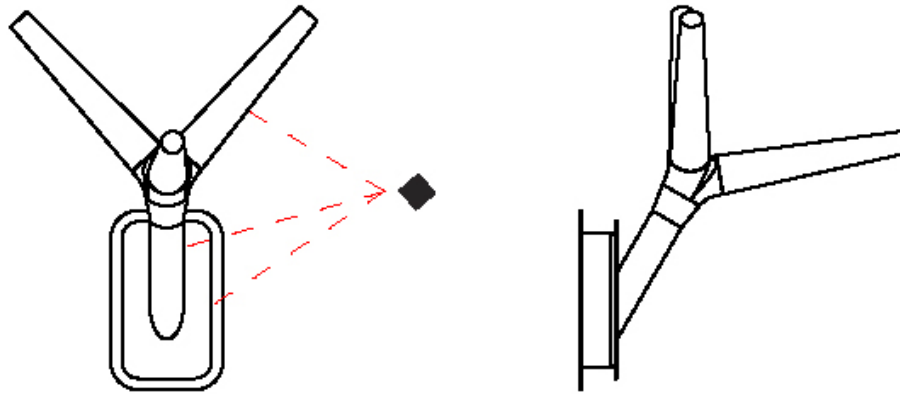

D

PROJECT	_____
TYPE	_____
SPECIFIER	_____
QUANTITY	_____
DATE	_____

SPARKS 7 SURFACE

D103142-

base number	LED Dimming	Finish Options
-------------	-------------	----------------

- To build a product code in our configurator select the specify button on the base model # product page
- To build a manual product code on this datasheet choose from the options listed below in blue font and add the suffix to the base model #

GENERAL

Series: Sparks
Subseries: Sparks 7
Brand: Quasar
Division: Design
Mounting Type: Surface
Mounting Location: Wall
Subcategory: Ambient

PHYSICAL

Shape: Abstract
Length (mm): 1100
Length (in): 43 ⁵ / ₁₆
Height (mm): 1800
Depth (mm): 900
Height (in): 70 ⁷ / ₈
Depth (in): 35 ⁷ / ₁₆
Light Distribution: Omnidirectional
Fixture Finish: WHI / PAL
Fixture Material: Metal

ELECTRICAL

Lamp Type: LED
Input Wattage (W): 32.2
Total Output Wattage (W): 22.4
Dimming: Non-Dimming / Phase Dimming (120Vac only) / 0-10V Dimming
Driver Included: Yes
Driver Location: Integrated
Driver Type: Constant Voltage - Universal
Driver Class: Class 2
Input Voltage (V): 120 - 277
Output Voltage (V): 24

LED

Number of LEDs: 7
Color Temperature (°K): 2700
Max. Delivered Lumen (lm): 2632
CRI: >90 CRI
Lamp Life (hrs): 50000

OPTICAL

RATINGS AND CERTIFICATIONS

Certified By: Certified for North American Standards
IP rating: IP20

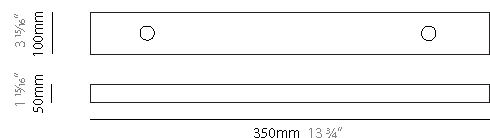
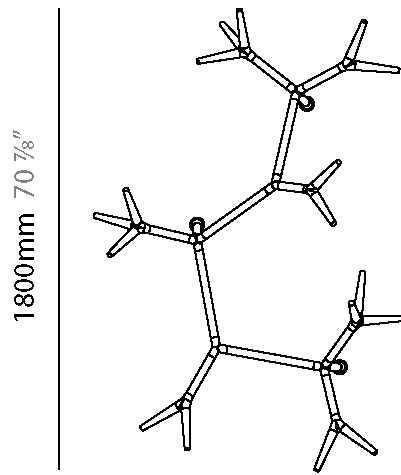
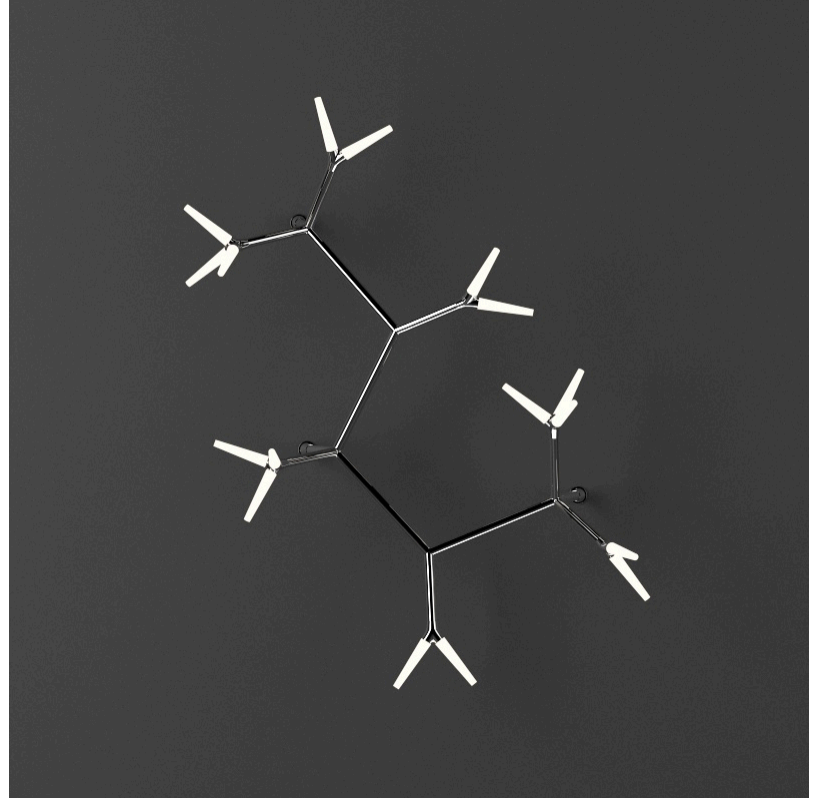

SPARKS 7 SURFACE

D103142-

PROJECT	_____
TYPE	_____
SPECIFIER	_____
QUANTITY	_____
DATE	_____

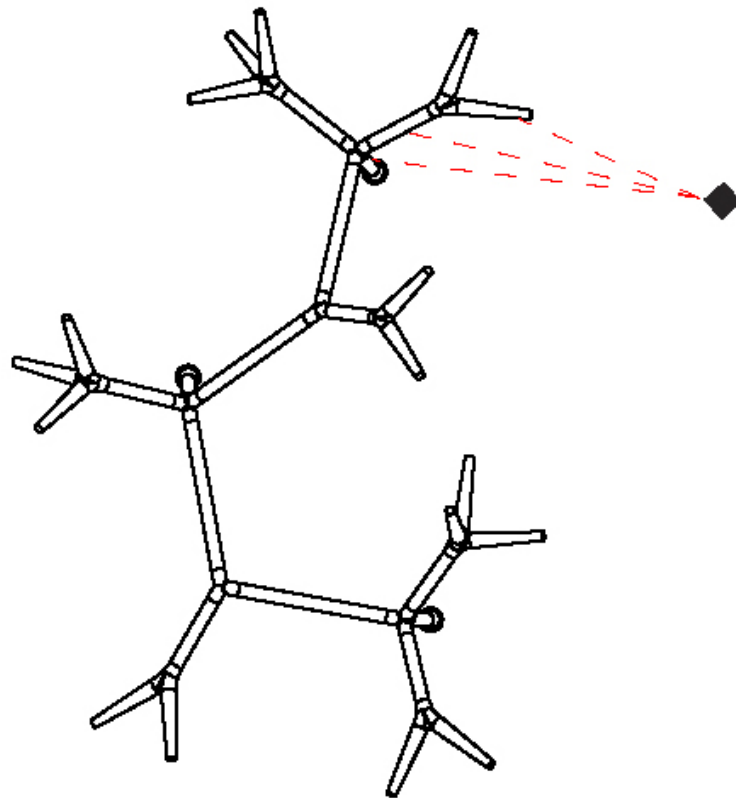

D

PROJECT	_____
TYPE	_____
SPECIFIER	_____
QUANTITY	_____
DATE	_____

SPARKS 9 SURFACE

D103143-

base number	LED	Finish
	Dimming	Options

- To build a product code in our configurator select the specify button on the base model # product page
- To build a manual product code on this datasheet choose from the options listed below in blue font and add the suffix to the base model #

GENERAL

Series: Sparks
Subseries: Sparks 9
Brand: Quasar
Division: Design
Mounting Type: Surface
Mounting Location: Wall
Subcategory: Ambient

PHYSICAL

Shape: Abstract
Length (mm): 1200
Length (in): 47 1/4
Height (mm): 2400
Depth (mm): 900
Height (in): 94 1/2
Depth (in): 35 7/16
Light Distribution: Omnidirectional
Fixture Finish: WHI / PAL
Fixture Material: Metal

ELECTRICAL

Lamp Type: LED
Input Wattage (W): 41.4
Total Output Wattage (W): 28.8
Dimming: Non-Dimming / Phase Dimming (120Vac only) / 0-10V Dimming
Driver Included: Yes
Driver Location: Integrated
Driver Type: Constant Voltage - Universal
Driver Class: Class 2
Input Voltage (V): 120 - 277
Output Voltage (V): 24

LED

Number of LEDs: 9
Color Temperature (°K): 2700
Max. Delivered Lumen (lm): 3384
CRI: >90 CRI
Lamp Life (hrs): 50000

OPTICAL

RATINGS AND CERTIFICATIONS

Certified By: Certified for North American Standards
IP rating: IP20

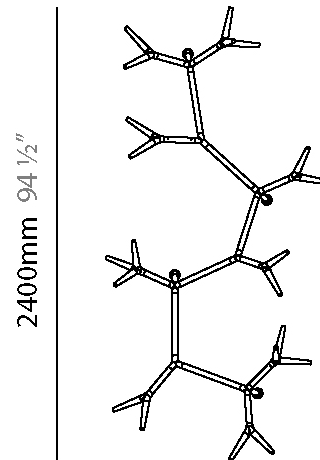
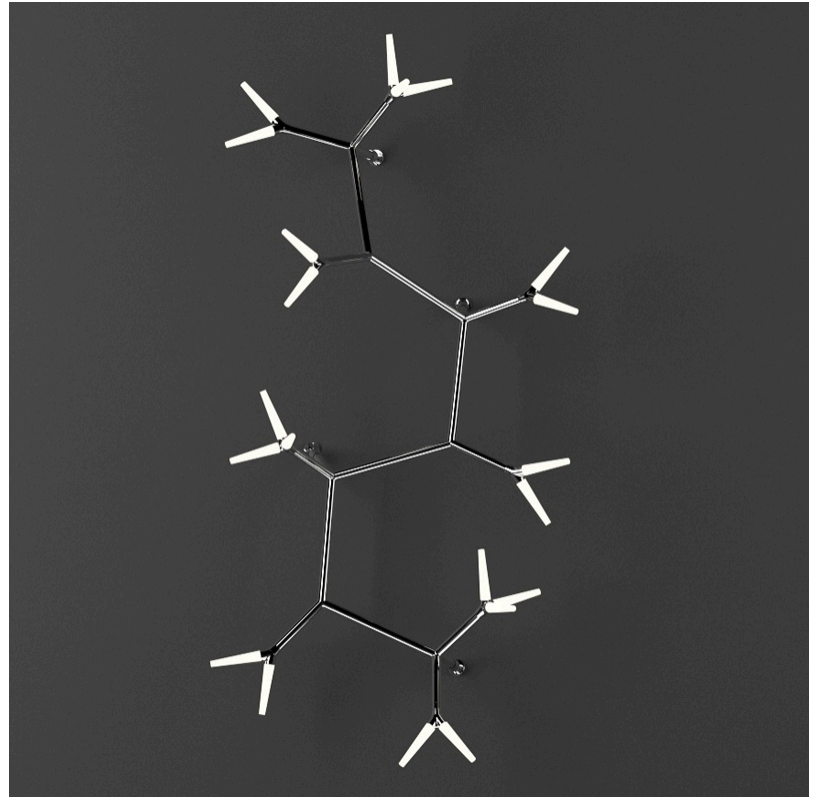

D103143-

PROJECT

TYPE

SPECIFIER

QUANTITY

DATE

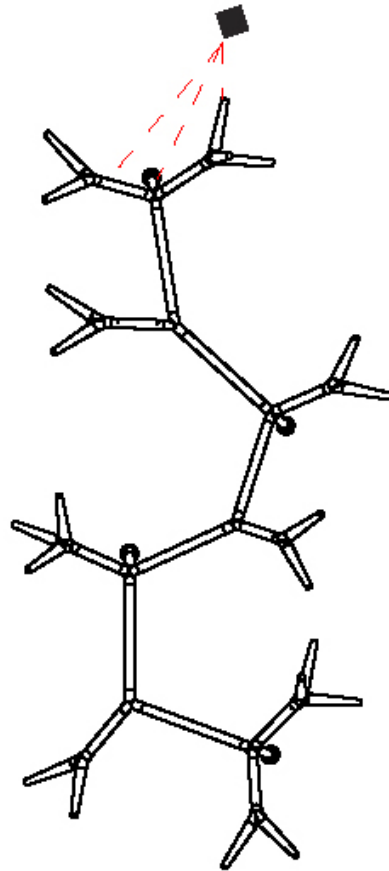

D

SPARKS 11 SURFACE

D103145-

base number LED Dimming - Finish Options

PROJECT _____

TYPE _____

SPECIFIER _____

QUANTITY _____

DATE _____

- To build a product code in our configurator select the specify button on the base model # product page
- To build a manual product code on this datasheet choose from the options listed below in blue font and add the suffix to the base model #

GENERAL

Series: Sparks _____

Subseries: Sparks 11 _____

Brand: Quasar _____

Division: Design _____

Mounting Type: Surface _____

Mounting Location: Wall _____

Subcategory: Ambient _____

PHYSICAL

Shape: Abstract _____

Length (mm): 1700 _____

Length (in): 66 ¹⁵/₁₆ _____

Height (mm): 2600 _____

Depth (mm): 900 _____

Height (in): 102 ³/₈ _____

Depth (in): 35 ⁷/₁₆ _____

Light Distribution: Omnidirectional _____

Fixture Finish: WHI / PAL _____

Fixture Material: Metal _____

ELECTRICAL

Lamp Type: LED _____

Input Wattage (W): 50.6 _____

Total Output Wattage (W): 35.2 _____

Dimming: Non-Dimming / Phase Dimming (120Vac only) / 0-10V Dimming _____

Driver Included: Yes _____

Driver Location: Integrated _____

Driver Type: Constant Voltage - Universal _____

Driver Class: Class 2 _____

Input Voltage (V): 120 - 277 _____

Output Voltage (V): 24 _____

LED

Number of LEDs: 11 _____

Color Temperature (°K): 2700 _____

Max. Delivered Lumen (lm): 4136 _____

CRI: >90 CRI _____

Lamp Life (hrs): 50000 _____

OPTICAL

RATINGS AND CERTIFICATIONS

Certified By: Certified for North American Standards _____

IP rating: IP20 _____

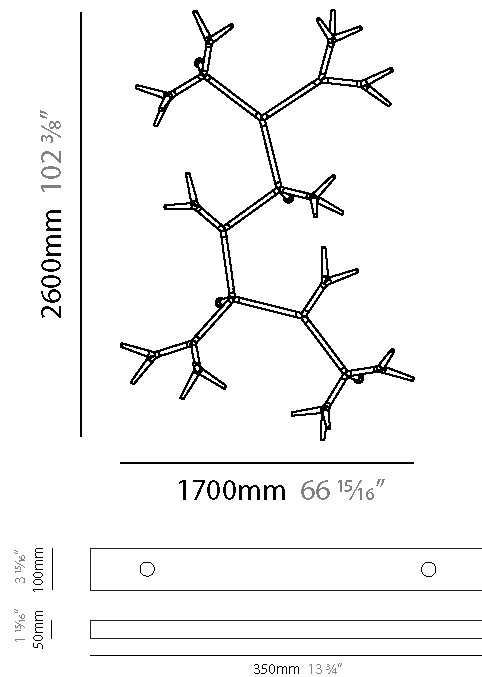
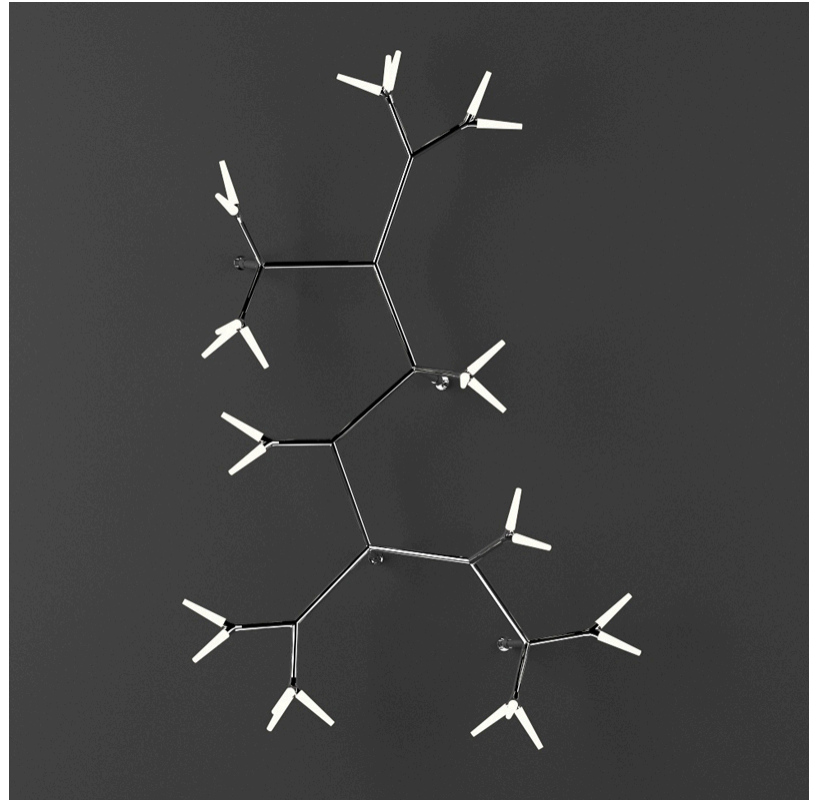

SPARKS 11 SURFACE

D103145-

PROJECT

TYPE

SPECIFIER

QUANTITY

DATE

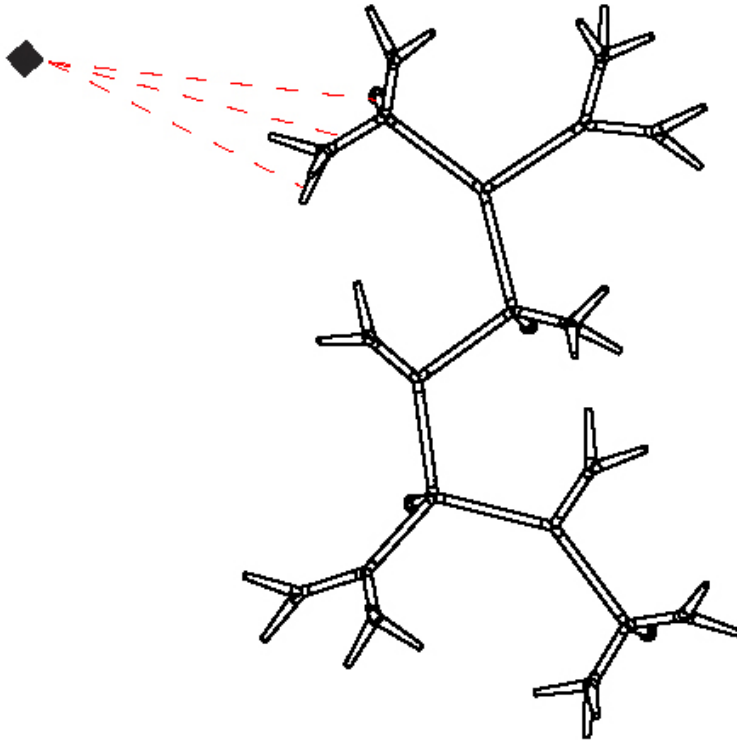

D

SPARKS 15 SURFACE

D103147-

base number LED Dimming Finish Options

- To build a product code in our configurator select the specify button on the base model # product page
- To build a manual product code on this datasheet choose from the options listed below in blue font and add the suffix to the base model #

GENERAL

Series: Sparks
 Subseries: Sparks 15
 Brand: Quasar
 Division: Design
 Mounting Type: Surface
 Mounting Location: Wall
 Subcategory: Ambient

PHYSICAL

Shape: Abstract
 Length (mm): 1900
 Length (in): 74 ¹³/₁₆
 Height (mm): 3340
 Depth (mm): 900
 Height (in): 131 ¹/₂
 Depth (in): 35 ⁷/₁₆
 Light Distribution: Omnidirectional
 Weight (kg): 17
 Weight (lbs): 37.48
 Fixture Finish: WHI / PAL
 Fixture Material: Metal

ELECTRICAL

Lamp Type: LED
 Input Wattage (W): 69
 Total Output Wattage (W): 48
 Dimming: Non-Dimming / Phase Dimming (120Vac only) / 0-10V Dimming
 Driver Included: Yes
 Driver Location: Integrated
 Driver Type: Constant Voltage - Universal
 Driver Class: Class 2
 Input Voltage (V): 120 - 277
 Output Voltage (V): 24

LED

Number of LEDs: 15
 Color Temperature (°K): 2700
 Max. Delivered Lumen (lm): 5640
 CRI: >90 CRI
 Lamp Life (hrs): 50000

OPTICAL

RATINGS AND CERTIFICATIONS

Certified By: Certified for North American Standards
 IP rating: IP20

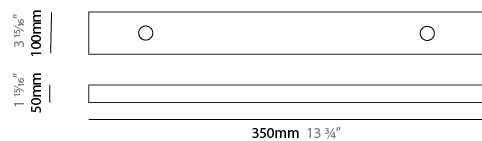
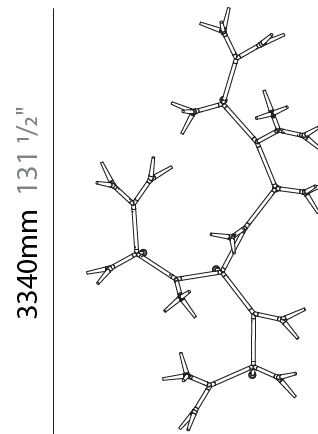
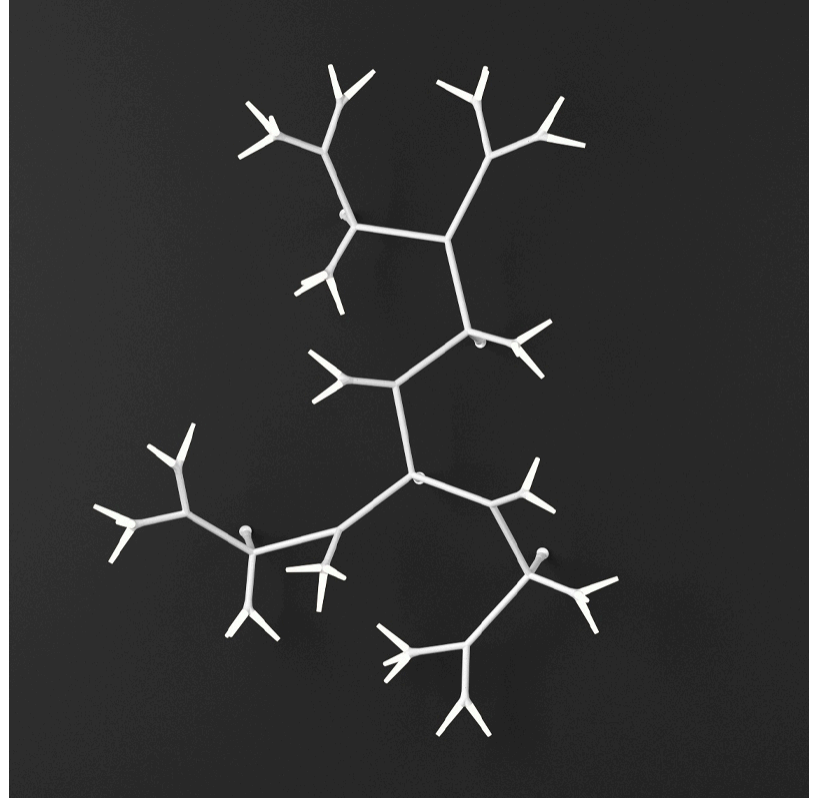

SPARKS 15 SURFACE

D103147-

PROJECT

TYPE

SPECIFIER

QUANTITY

DATE

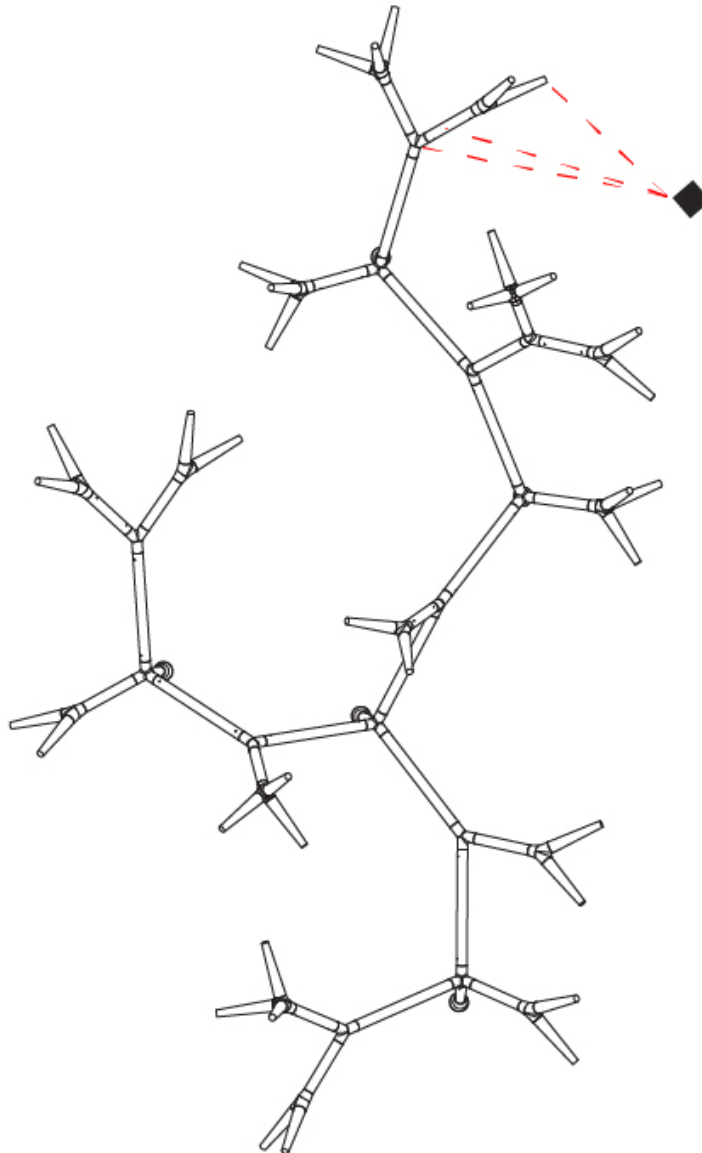

D

SPARKS 17 SURFACE

D103148-

base number LED Dimming Finish Options

- To build a product code in our configurator select the specify button on the base model # product page
- To build a manual product code on this datasheet choose from the options listed below in blue font and add the suffix to the base model #

GENERAL

Series: Sparks
 Subseries: Sparks 17
 Brand: Quasar
 Division: Design
 Mounting Type: Surface
 Mounting Location: Wall
 Subcategory: Ambient

PHYSICAL

Shape: Abstract
 Length (mm): 2590
 Length (in): 101 ¹⁵/₁₆
 Height (mm): 3250
 Depth (mm): 900
 Height (in): 127 ¹⁵/₁₆
 Depth (in): 35 ⁷/₁₆
 Light Distribution: Omnidirectional
 Weight (kg): 21
 Weight (lbs): 46.30
 Fixture Finish: WHI / PAL
 Fixture Material: Metal

ELECTRICAL

Lamp Type: LED
 Input Wattage (W): 78.2
 Total Output Wattage (W): 54.4
 Dimming: Non-Dimming / Phase Dimming (120Vac only) / 0-10V Dimming
 Driver Included: Yes
 Driver Location: Integrated
 Driver Type: Constant Voltage - Universal
 Driver Class: Class 2
 Input Voltage (V): 120 - 277
 Output Voltage (V): 24

LED

Number of LEDs: 17
 Color Temperature (°K): 2700
 Max. Delivered Lumen (lm): 6392
 CRI: >90 CRI
 Lamp Life (hrs): 50000

OPTICAL

RATINGS AND CERTIFICATIONS

Certified By: Certified for North American Standards
 IP rating: IP20

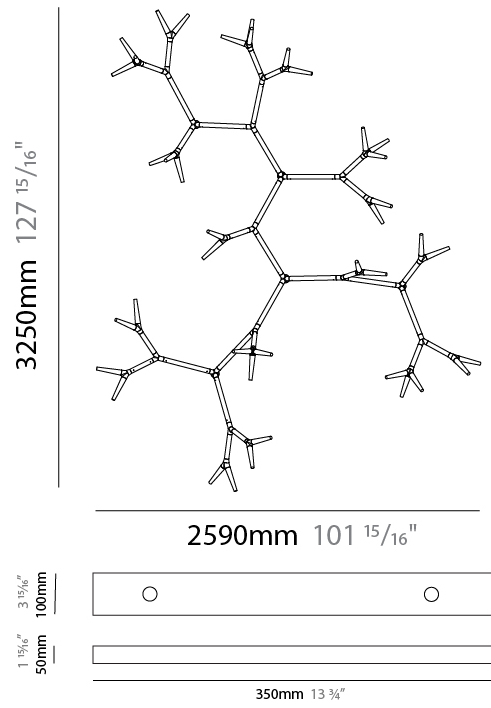
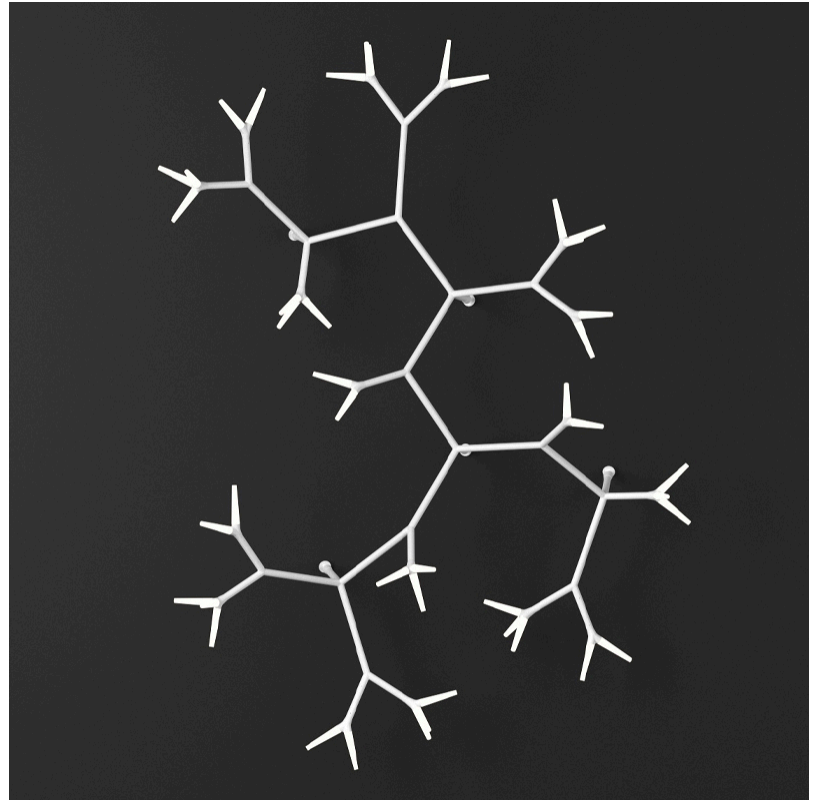

SPARKS 17 SURFACE

D103148-

PROJECT

TYPE

SPECIFIER

QUANTITY

DATE

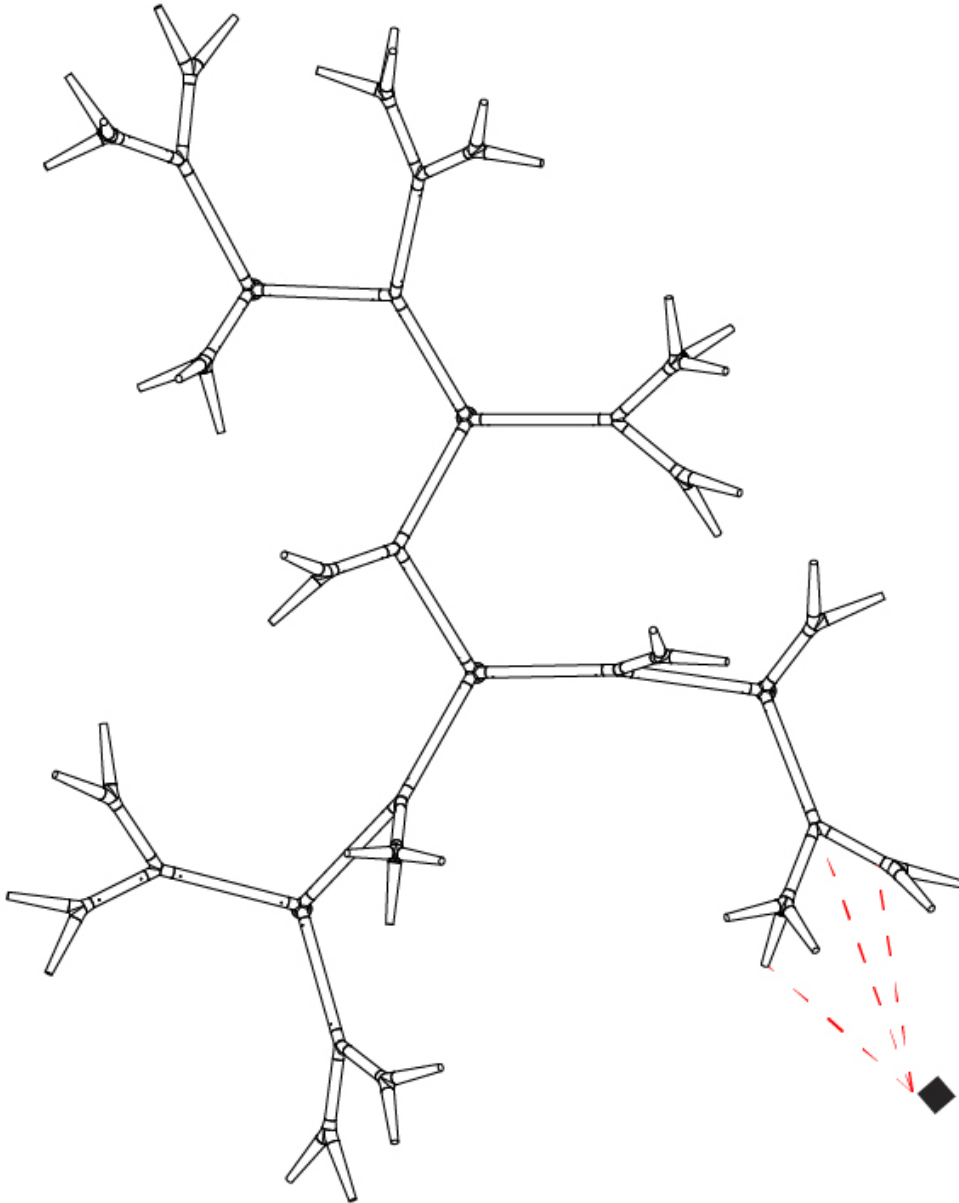

D

PROJECT	
TYPE	
SPECIFIER	
QUANTITY	
DATE	

SPARKS 19 SURFACE

D103149-

base number	LED Dimming	Finish Options
-------------	-------------	----------------

- To build a product code in our configurator select the specify button on the base model # product page
- To build a manual product code on this datasheet choose from the options listed below in blue font and add the suffix to the base model #

GENERAL

Series: Sparks
Subseries: Sparks 19
Brand: Quasar
Division: Design
Mounting Type: Surface
Mounting Location: Wall
Subcategory: Ambient

PHYSICAL

Shape: Abstract
Length (mm): 1880
Length (in): 74
Height (mm): 5300
Depth (mm): 900
Height (in): 208 ¹¹ / ₁₆
Depth (in): 35 ⁷ / ₁₆
Light Distribution: Omnidirectional
Weight (kg): 24
Weight (lbs): 52.91
Fixture Finish: WHI / PAL
Fixture Material: Metal

ELECTRICAL

Lamp Type: LED
Input Wattage (W): 87.4
Total Output Wattage (W): 60.8
Dimming: 0-10V Dimming / Phase Dimming (120Vac Only)
Driver Included: Yes
Driver Location: Integrated
Driver Type: Constant Voltage - Universal
Driver Class: Class 2
Input Voltage (V): 120 - 277
Output Voltage (V): 24

LED

Number of LEDs: 19
Color Temperature (°K): 2700
Max. Delivered Lumen (lm): 7144
CRI: >90 CRI
Lamp Life (hrs): 50000

OPTICAL

RATINGS AND CERTIFICATIONS

Certified By: Certified for North American Standards
IP rating: IP20

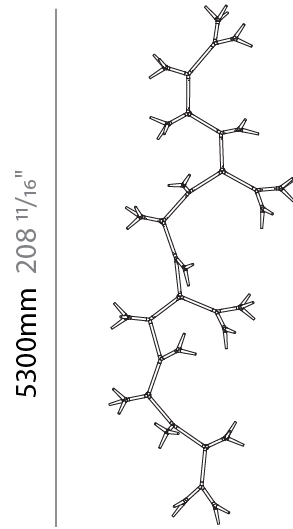
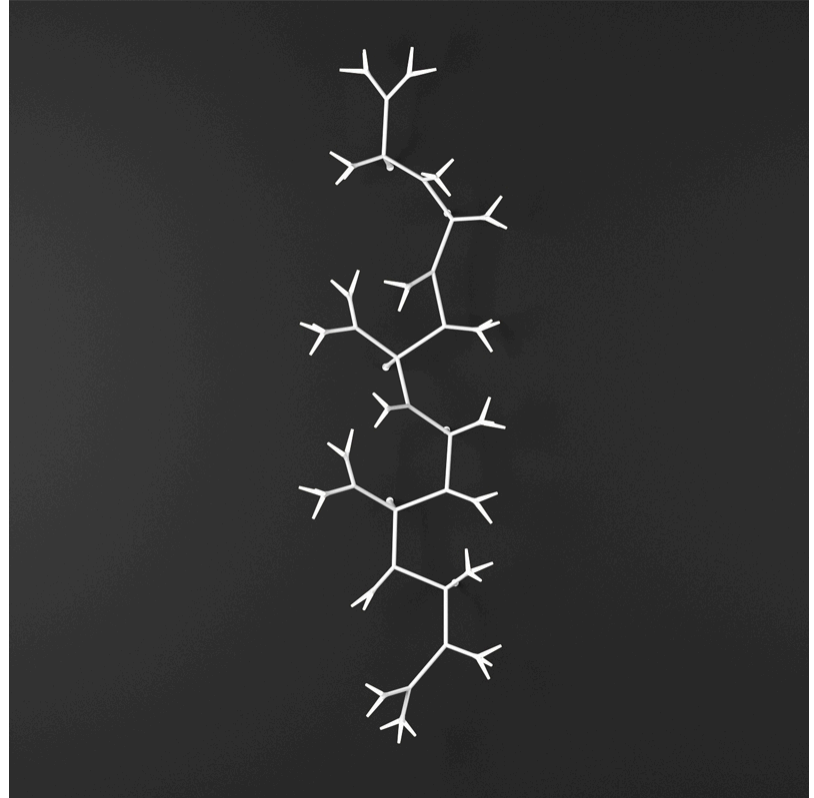

1880mm 74"

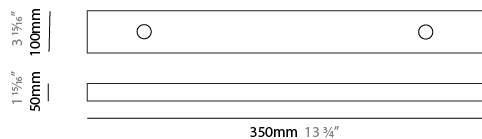

SPARKS 19 SURFACE

D103149-

PROJECT

TYPE

SPECIFIER

QUANTITY

DATE

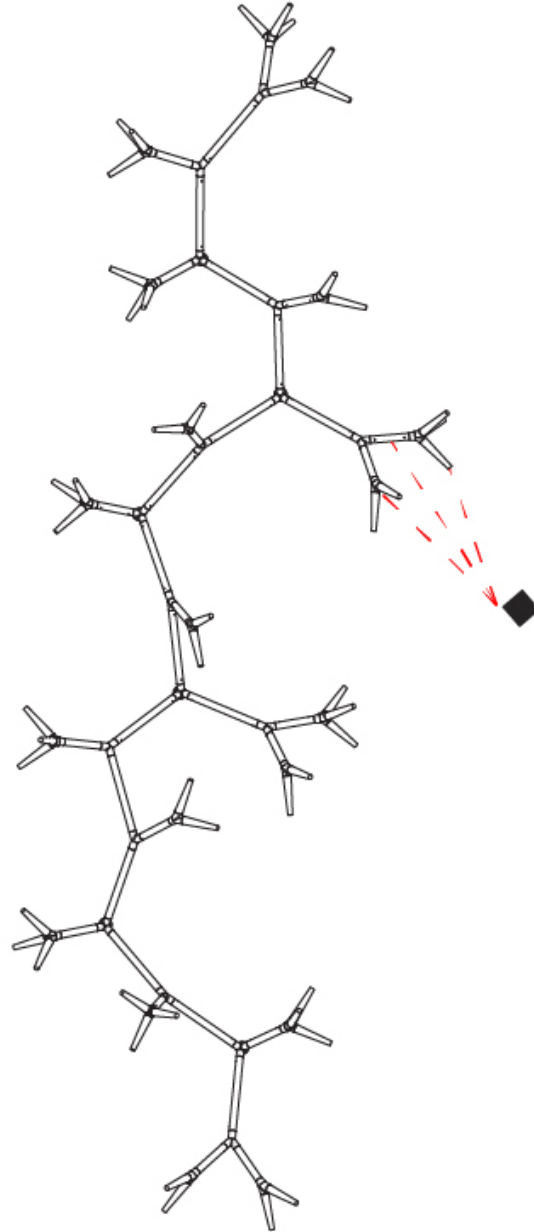

D

PROJECT	_____
TYPE	_____
SPECIFIER	_____
QUANTITY	_____
DATE	_____

SPARKS MODULAR SYSTEM SURFACE

D10SP-MOD-SYS

base number

1. To build a product code in our configurator select the specify button on the base model # product page
2. To build a manual product code on this datasheet choose from the options listed below in blue font and add the suffix to the base model #

GENERAL

Series: Sparks
Subseries: Sparks Modular System
Brand: Quasar
Division: Design
Mounting Type: Surface
Mounting Location: Ceiling
Subcategory: Modular

PHYSICAL

Shape: Abstract
Light Distribution: Omnidirectional
Fixture Finish: WHI / PAL
Fixture Material: Metal

ELECTRICAL

Lamp Type: LED
Dimming: Non-Dimming / Phase Dimming (120Vac only) / 0-10V Dimming
Driver Included: No
Driver Location: Remote
Driver Type: Constant Voltage - Universal
Driver Class: Class 2
Input Voltage (V): 120 - 277
Output Voltage (V): 24

LED

Color Temperature (°K): 2700
CRI: >90 CRI
Lamp Life (hrs): 50000

OPTICAL

RATINGS AND CERTIFICATIONS

Certified By: Certified for North American Standards
IP rating: IP20

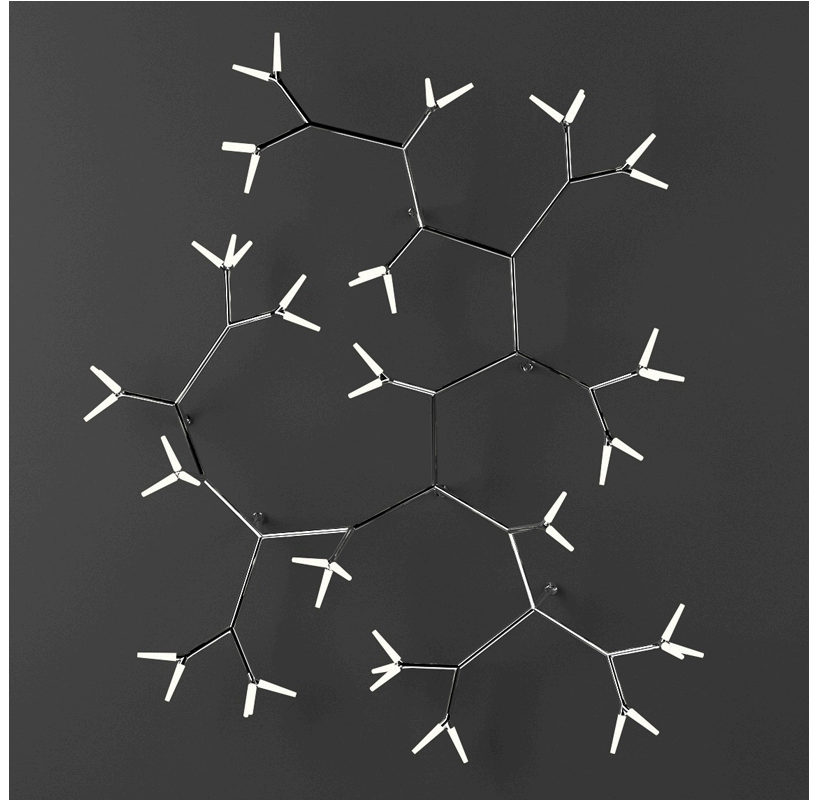

PROJECT

TYPE

SPECIFIER

QUANTITY

DATE

Fixture Finish

White - WHI



Polished Aluminum - PAL

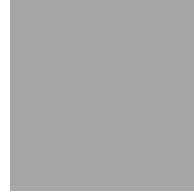

Digital: Not all screens are calibrated the same, and therefore, colors will appear differently between screens.

Physical: When texture is involved, there will be variations in color, character and tone within a product series and between product families.



PROJECT	
TYPE	
SPECIFIER	
QUANTITY	
DATE	

LEGEND

	floor-mounted		pivotal		special LED (upon request) RGB, RGBW, tunable, gold+, meat+, art+, fashion+
	wall and ceiling: recessed and surface mounted		rotating		warm dim / natural dimming LED
	ceiling-mounted and wall-mounted		illuminate tilted		rechargeable battery powered
	wall-mounted		color of suspension cable		fixture with natural vivid LED (upon request)
	omni-directional light distribution		length of suspension cable		color rendering index
	direct light distribution		reflector degree selection		color temperature
	direct/indirect light distribution		super spot		lumen (luminous flux)
	indirect light distribution		lens		efficacy (lumens per watt)
	asymmetric light distribution		lens pack		Unified Glare Rating (UGR) range from 5-40
	aura light distribution		shine ring		marine grade (AISI 316 stainless steel)
	round wall or ceiling cut-out		integrated shine ring with diffuser		walk on
	square wall or ceiling cut-out		free individual colors 01-29		drive on
	the supplied jig specifies the cutout dimensions		individual colors: 00 (free of charge), 01-25 (extra charge)		Dark Sky Compliance
	minimum distance (meters) lamp - object		luminaire part to be colored (F1)		Americans with Disabilities Act (less than 4" off the wall located between 27"-84" from floor)
	recessed depth		luminaire part to be colored (F2)		lamp protected against explosion
	ceiling thickness in mm		luminaire part to be colored (F3)		blown glass using traditional methods by master glass blower
	ceiling thickness selection		luminaire part to be colored (F4)		acoustic material
	dimnable DP (phase), DV (0-10V), DD (dali), DS (step-dim)		luminaire part to be colored (F5)		protection class I, protection insulation
	included or excluded LED driver/transformer/control gear		color of 3-circuit adaptor		protection class II, protection insulation
	separately switchable		indirect diffuser		ETL Certified to UL and CSA Standards
	sensor		direct diffuser		UL Certified to UL and CSA Standards
	remote control		ball-proof (upon request)		CSA Certified to UL and CSA Standards
	available upon request		accessory		Certified for North American Standards

IP RATING

	protected against ingress of solid bodies greater than 12.5mm (finger)
	protected against ingress of solid bodies greater than 2.5mm protected against sprays of water up to 60 degrees from the vertical (rain)
	protected against ingress of solid bodies greater than 1mm (wire) no protection against the ingress of moisture
	protected against ingress of solid bodies greater than 1mm (wire) protected against sprays of water up to 60 degrees from the vertical (rain)
	protected against ingress of solid bodies greater than 1mm (wire) protected against water splashed from all directions
	protected against limited ingress of dust (wet rooms/covered outdoor areas) protected against water splashed from all directions
	protected against ingress of dust protected against jets of water
	protected against ingress of dust protected against powerful jets of water or heavy seas
	protected against ingress of dust protected against immersion of water between 15cm - 1m for 30 minutes
	protected against ingress of dust protected against immersion of water under pressure for long periods

IK RATING

	protected against 0.14 joules impact (equivalent to 0.25kg mass dropped from 56mm above the surface)
	protected against 0.2 joules impact (equivalent to 0.25kg mass dropped from 80mm above the surface)
	protected against 0.35 joules impact (equivalent to 0.25kg mass dropped from 140mm above the surface)
	protected against 0.5 joules impact (equivalent to 0.25kg mass dropped from 200mm above the surface)
	protected against 0.7 joules impact (equivalent to 0.25kg mass dropped from 280mm above the surface)
	protected against 1 joules impact (equivalent to 0.25kg mass dropped from 400mm above the surface)
	protected against 2 joules impact (equivalent to 0.5kg mass dropped from 400mm above the surface)
	protected against 5 joules impact (equivalent to 1.7kg mass dropped from 300mm above the surface)
	protected against 10 joules impact (equivalent to 5.0kg mass dropped from 200mm above the surface)
	protected against 20 joules impact (equivalent to 5.0kg mass dropped from 400mm above the surface)