

## SPARKS 3 SUSPENSION

**D101686-** \_\_\_\_\_ - \_\_\_\_\_

base number      LED Dimming      Finish Options

- To build a product code in our configurator select the specify button on the base model # product page
- To build a manual product code on this datasheet choose from the options listed below in blue font and add the suffix to the base model #

### GENERAL

Series: Sparks  
 Subseries: Sparks 3  
 Brand: Quasar  
 Division: Design  
 Mounting Type: Suspension  
 Mounting Location: Ceiling  
 Subcategory: Ambient

### PHYSICAL

Shape: Abstract  
 Diameter (mm): 780  
 Diameter (in): 30 <sup>11</sup>/<sub>16</sub>  
 Height (mm): 520  
 Height (in): 20 <sup>1</sup>/<sub>2</sub>  
 Max. Overall Height (mm): 2520  
 Max. Overall Height (in): 99 <sup>3</sup>/<sub>16</sub>  
 Light Distribution: Omnidirectional  
 Weight (kg): 5  
 Weight (lbs): 11.02  
[Fixture Finish: WHI / PAL](#)  
 Fixture Material: Metal  
 Cable Details: 2000mm Cable

### ELECTRICAL

Lamp Type: LED  
 Input Wattage (W): 13.8  
 Total Output Wattage (W): 9.6  
[Dimming: Non-Dimming / Phase Dimming \(120vac Only\)](#)  
 Driver Included: Yes  
 Driver Location: Integrated  
 Driver Type: Constant Voltage - Universal  
 Driver Class: Class 2  
 Input Voltage (V): 120 - 277  
 Output Voltage (V): 24  
 Upon Request: (Not included - see components) Remote: 0-10Vdc dimming

### LED

Number of LEDs: 3  
 Color Temperature (°K): 2700  
 Max. Delivered Lumen (lm): 1128  
 CRI: >90 CRI  
 Lamp Life (hrs): 50000

### OPTICAL

### RATINGS AND CERTIFICATIONS

Certified By: Certified for North American Standards  
 IP rating: IP20

PROJECT	_____
TYPE	_____
SPECIFIER	_____
QUANTITY	_____
DATE	_____

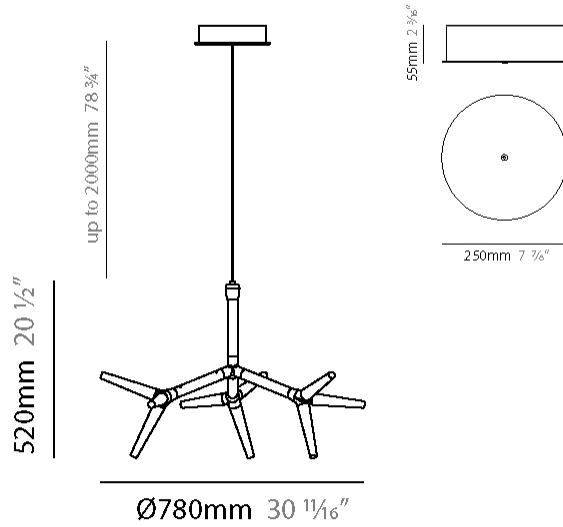

## SPARKS 3 SUSPENSION

D101686-

PROJECT \_\_\_\_\_

TYPE \_\_\_\_\_

SPECIFIER \_\_\_\_\_

QUANTITY \_\_\_\_\_

DATE \_\_\_\_\_



D

PROJECT	
TYPE	
SPECIFIER	
QUANTITY	
DATE	

## SPARKS 6 SUSPENSION

### D101688-

base number      LED Dimming      Finish Options

- To build a product code in our configurator select the specify button on the base model # product page
- To build a manual product code on this datasheet choose from the options listed below in blue font and add the suffix to the base model #

#### GENERAL

Series: Sparks  
 Subseries: Sparks 6  
 Brand: Quasar  
 Division: Design  
 Mounting Type: Suspension  
 Mounting Location: Ceiling  
 Subcategory: Ambient

#### PHYSICAL

Shape: Abstract  
 Length (mm): 1300  
 Length (in): 51 <sup>3</sup>/<sub>16</sub>"  
 Width (mm): 730  
 Width (in): 28 <sup>3</sup>/<sub>4</sub>"  
 Height (mm): 980  
 Height (in): 38 <sup>9</sup>/<sub>16</sub>"  
 Max. Overall Height (mm): 2980  
 Max. Overall Height (in): 117 <sup>5</sup>/<sub>16</sub>"  
 Light Distribution: Omnidirectional  
 Weight (kg): 7  
 Weight (lbs): 15.43  
 Fixture Finish: WHI / PAL  
 Fixture Material: Metal  
 Cable Details: 2000mm Cable

#### ELECTRICAL

Lamp Type: LED  
 Input Wattage (W): 27.6  
 Total Output Wattage (W): 19.2  
 Dimming: Non-Dimming / Phase Dimming (120vac Only)  
 Driver Included: Yes  
 Driver Location: Integrated  
 Driver Type: Constant Voltage - Universal  
 Driver Class: Class 2  
 Input Voltage (V): 120 - 277  
 Output Voltage (V): 24  
 Upon Request: (Not included - see components) Remote: 0-10Vdc dimming

#### LED

Number of LEDs: 6  
 Color Temperature (°K): 2700  
 Max. Delivered Lumen (lm): 2256  
 CRI: >90 CRI  
 Lamp Life (hrs): 50000

#### OPTICAL

#### RATINGS AND CERTIFICATIONS

Certified By: Certified for North American Standards  
 IP rating: IP20

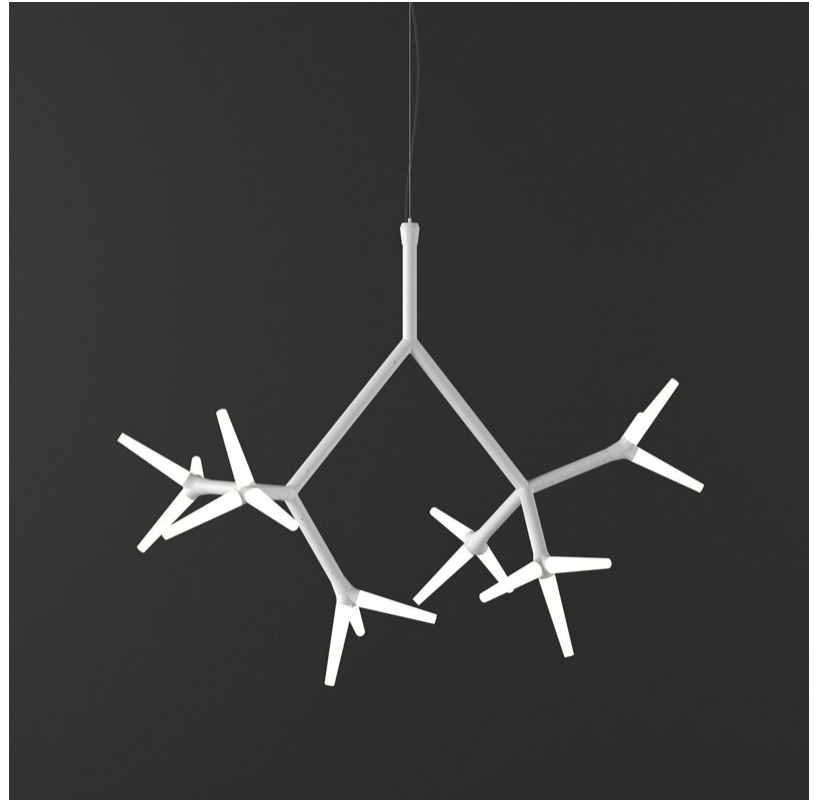

## SPARKS 6 SUSPENSION

D101688-

PROJECT \_\_\_\_\_

TYPE \_\_\_\_\_

SPECIFIER \_\_\_\_\_

QUANTITY \_\_\_\_\_

DATE \_\_\_\_\_

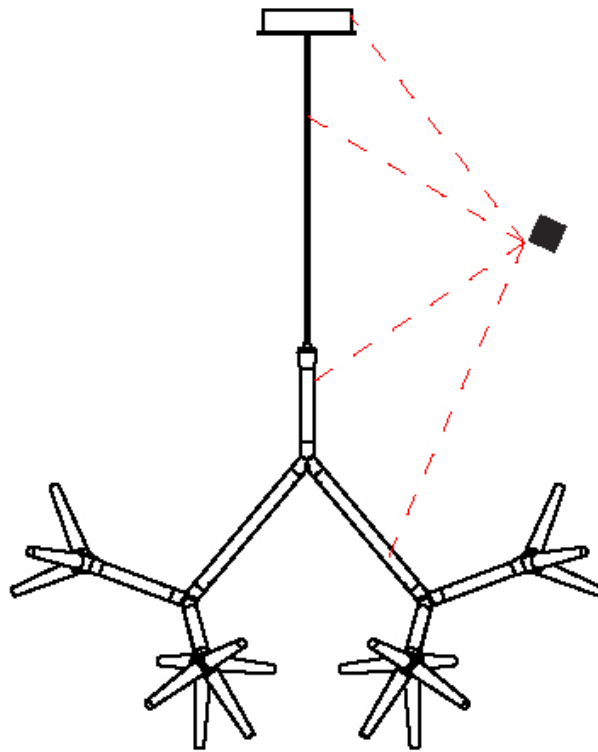

D

PROJECT	_____
TYPE	_____
SPECIFIER	_____
QUANTITY	_____
DATE	_____

## SPARKS 9 SUSPENSION

### D101690-

base number	LED	Finish
	Dimming	Options

- To build a product code in our configurator select the specify button on the base model # product page
- To build a manual product code on this datasheet choose from the options listed below in blue font and add the suffix to the base model #

#### GENERAL

Series: Sparks
Subseries: Sparks 9
Brand: Quasar
Division: Design
Mounting Type: Suspension
Mounting Location: Ceiling
Subcategory: Ambient

#### PHYSICAL

Shape: Abstract
Diameter (mm): 1370
Diameter (in): 53 <sup>15</sup> / <sub>16</sub>
Height (mm): 800
Height (in): 31 <sup>1</sup> / <sub>2</sub>
Max. Overall Height (mm): 2800
Max. Overall Height (in): 110 <sup>3</sup> / <sub>4</sub>
Light Distribution: Omnidirectional
Weight (kg): 10
Weight (lbs): 22.05
Fixture Finish: WHI / PAL
Fixture Material: Metal
Cable Details: 2000mm Cable

#### ELECTRICAL

Lamp Type: LED
Input Wattage (W): 41.4
Total Output Wattage (W): 28.8
Dimming: Non-Dimming / Phase Dimming (120vac Only)
Driver Included: Yes
Driver Location: Integrated
Driver Type: Constant Voltage - Universal
Driver Class: Class 2
Input Voltage (V): 120 - 277
Output Voltage (V): 24
Upon Request: (Not included - see components) Remote: 0-10Vdc dimming

#### LED

Number of LEDs: 9
Color Temperature (°K): 2700
Max. Delivered Lumen (lm): 3384
CRI: >90 CRI
Lamp Life (hrs): 50000

#### OPTICAL

#### RATINGS AND CERTIFICATIONS

Certified By: Certified for North American Standards
IP rating: IP20



## SPARKS 9 SUSPENSION

D101690-

PROJECT \_\_\_\_\_

TYPE \_\_\_\_\_

SPECIFIER \_\_\_\_\_

QUANTITY \_\_\_\_\_

DATE \_\_\_\_\_

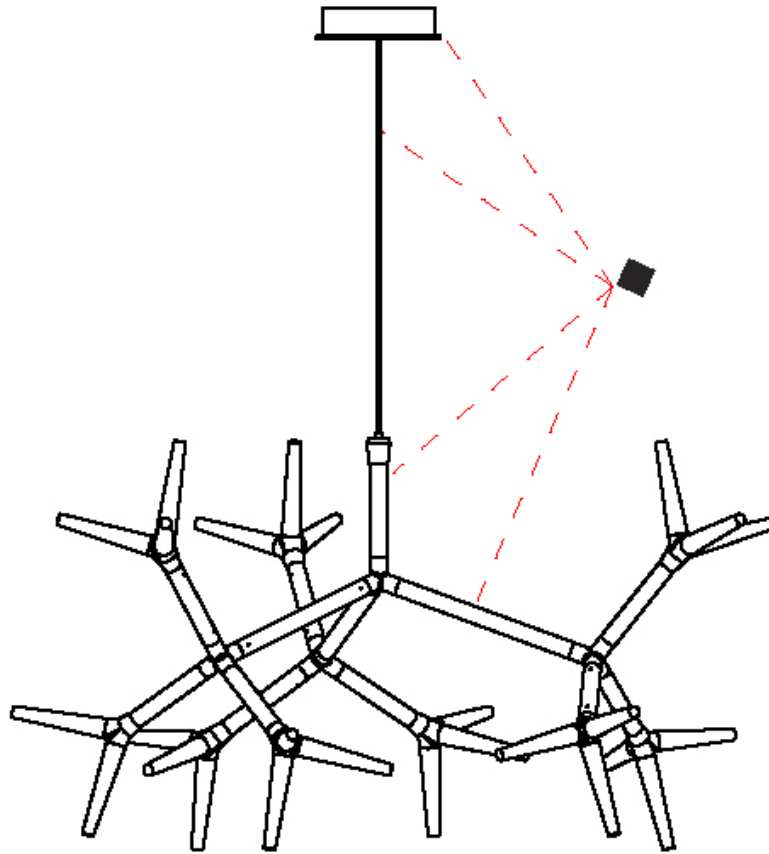

D

PROJECT	
TYPE	
SPECIFIER	
QUANTITY	
DATE	

## SPARKS 6 SUSPENSION

### D101692-

base number	LED Dimming	Finish Options
-------------	-------------	----------------

- To build a product code in our configurator select the specify button on the base model # product page
- To build a manual product code on this datasheet choose from the options listed below in blue font and add the suffix to the base model #

#### GENERAL

Series: Sparks
Subseries: Sparks 6
Brand: Quasar
Division: Design
Mounting Type: Suspension
Mounting Location: Ceiling
Subcategory: Ambient

#### PHYSICAL

Shape: Abstract
Length (mm): 1900
Length (in): 74 <sup>13</sup> / <sub>16</sub>
Width (mm): 870
Width (in): 34 <sup>1</sup> / <sub>4</sub>
Height (mm): 860
Height (in): 33 <sup>7</sup> / <sub>8</sub>
Max. Overall Height (mm): 2860
Max. Overall Height (in): 112 <sup>5</sup> / <sub>8</sub>
Light Distribution: Omnidirectional
Weight (kg): 7
Weight (lbs): 15.43
Fixture Finish: WHI / PAL
Fixture Material: Metal
Cable Details: 2000mm Cable

#### ELECTRICAL

Lamp Type: LED
Input Wattage (W): 27.6
Total Output Wattage (W): 19.2
Dimming: Non-Dimming / Phase Dimming (120Vac only) / 0-10V Dimming
Driver Included: Yes
Driver Location: Integrated
Driver Type: Constant Voltage - Universal
Driver Class: Class 2
Input Voltage (V): 120 - 277
Output Voltage (V): 24

#### LED

Number of LEDs: 6
Color Temperature (°K): 2700
Max. Delivered Lumen (lm): 2256
CRI: >90 CRI
Lamp Life (hrs): 50000

#### OPTICAL

#### RATINGS AND CERTIFICATIONS

Certified By: Certified for North American Standards
IP rating: IP20

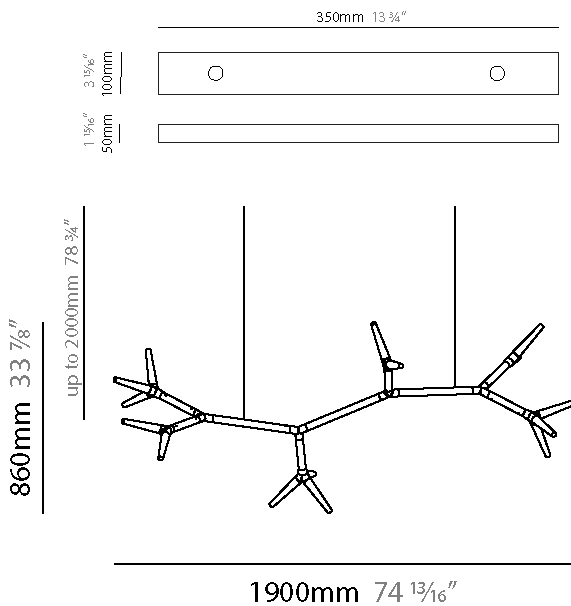
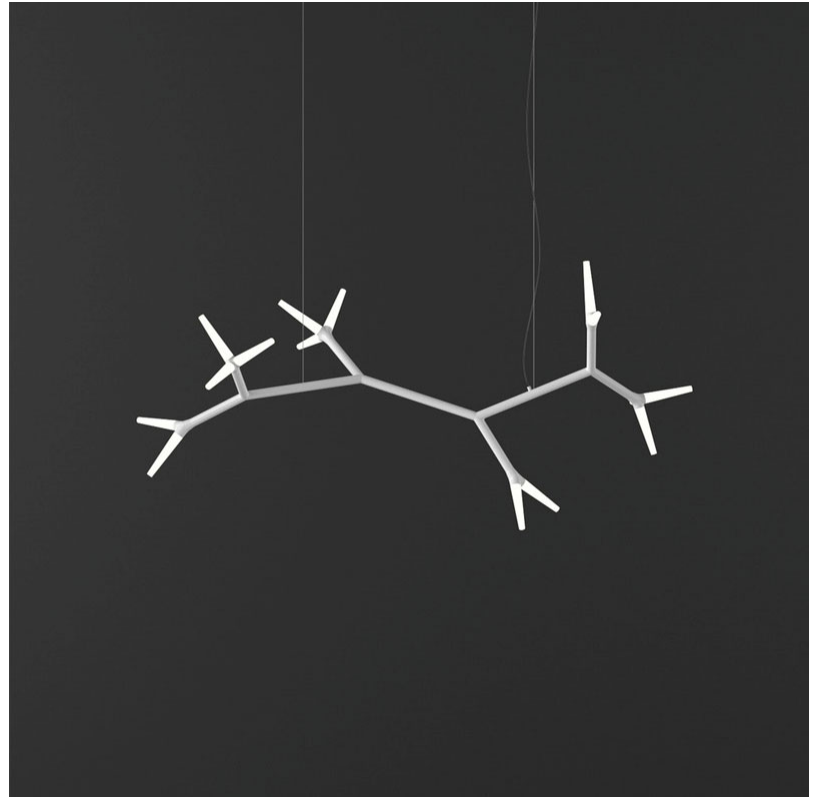

## SPARKS 6 SUSPENSION

D101692-

PROJECT \_\_\_\_\_

TYPE \_\_\_\_\_

SPECIFIER \_\_\_\_\_

QUANTITY \_\_\_\_\_

DATE \_\_\_\_\_

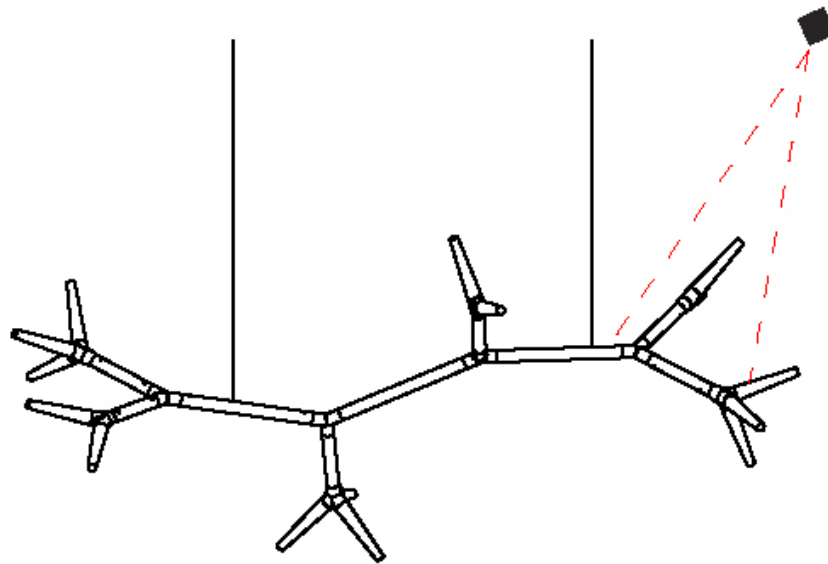

D



## SPARKS 10 SUSPENSION

### D101720-

base number      LED Dimming      -      Finish Options

- To build a product code in our configurator select the specify button on the base model # product page
- To build a manual product code on this datasheet choose from the options listed below in blue font and add the suffix to the base model #

#### GENERAL

Series: Sparks  
 Subseries: Sparks 10  
 Brand: Quasar  
 Division: Design  
 Mounting Type: Suspension  
 Mounting Location: Ceiling  
 Subcategory: Ambient

#### PHYSICAL

Shape: Abstract  
 Length (mm): 3000  
 Length (in): 118 1/8  
 Width (mm): 1000  
 Width (in): 39 5/8  
 Height (mm): 800  
 Height (in): 31 1/2  
 Max. Overall Height (mm): 2800  
 Max. Overall Height (in): 110 1/4  
 Light Distribution: Omnidirectional  
 Weight (kg): 10  
 Weight (lbs): 22.05  
 Fixture Finish: WHI / PAL  
 Fixture Material: Metal  
 Cable Details: 2000mm Cable

#### ELECTRICAL

Lamp Type: LED  
 Input Wattage (W): 46  
 Dimming: Non-Dimming / Phase Dimming (120Vac only) / 0-10V Dimming  
 Driver Included: Yes  
 Driver Location: Integrated  
 Driver Type: Constant Voltage - Universal  
 Driver Class: Class 2  
 Input Voltage (V): 120 - 277  
 Output Voltage (V): 24

#### LED

Number of LEDs: 10  
 Color Temperature (°K): 2700  
 Max. Delivered Lumen (lm): 3760  
 CRI: >90 CRI  
 Lamp Life (hrs): 50000

#### OPTICAL

#### RATINGS AND CERTIFICATIONS

Certified By: Certified for North American Standards  
 IP rating: IP20

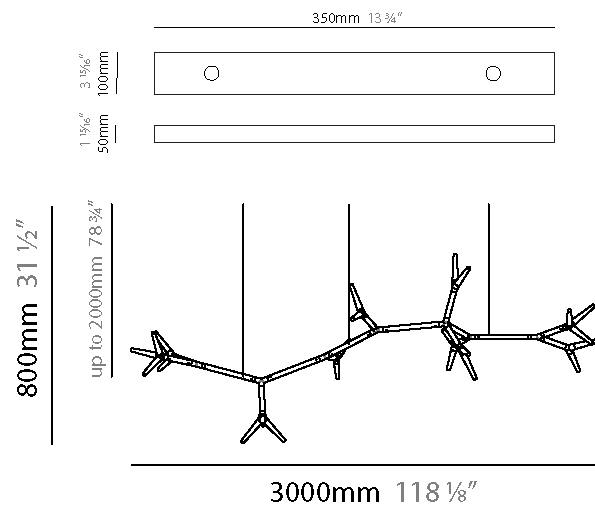

## SPARKS 10 SUSPENSION

D101720-

PROJECT

TYPE

SPECIFIER

QUANTITY

DATE



D

PROJECT	
TYPE	
SPECIFIER	
QUANTITY	
DATE	

## SPARKS DOUBLE HEAD SURFACE

### D103134-

base number Finish  
Options

- To build a product code in our configurator select the specify button on the base model # product page
- To build a manual product code on this datasheet choose from the options listed below in blue font and add the suffix to the base model #

#### GENERAL

Series: Sparks  
Subseries: Sparks Double Head  
Brand: Quasar  
Division: Design  
Mounting Type: Surface  
Mounting Location: Wall  
Subcategory: Ambient

#### PHYSICAL

Shape: Abstract  
Length (mm): 225  
Length (in): 8 7/8  
Height (mm): 330  
Depth (mm): 190  
Height (in): 13  
Depth (in): 7 1/2  
Light Distribution: Omnidirectional  
Weight (kg): 3  
Weight (lbs): 6.6  
[Fixture Finish: WHI / PAL](#)  
Fixture Material: Metal

#### ELECTRICAL

Lamp Type: LED  
Input Wattage (W): 4.2  
Total Output Wattage (W): 3.2  
Dimming: Non-Dimmable  
Driver Included: Yes  
Driver Location: Integrated  
Driver Type: Constant Current - Universal  
Driver Class: Class 2  
Input Voltage (V): 120 - 277  
Constant Current (MA): 350  
Upon Request: (Not included - see components) Remote: 0-10Vdc dimming / Phase dimming @120Vac only

#### LED

Number of LEDs: 1  
Color Temperature (°K): 2700  
Max. Delivered Lumen (lm): 376  
CRI: >90 CRI  
Lamp Life (hrs): 50000

#### OPTICAL

#### RATINGS AND CERTIFICATIONS

Certified By: Certified for North American Standards  
IP rating: IP20

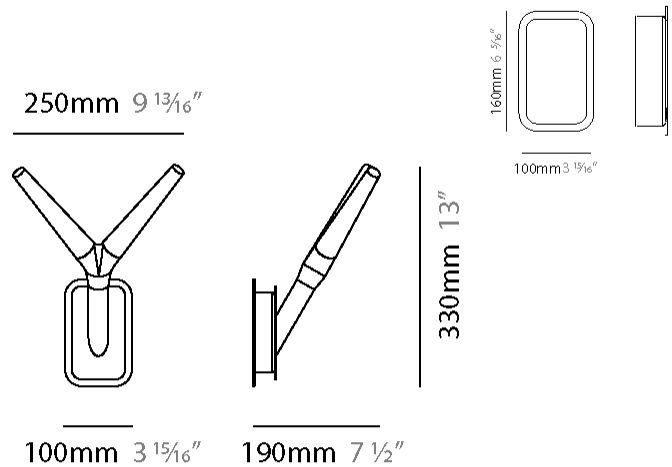

## SPARKS DOUBLE HEAD SURFACE

D103134-

PROJECT	_____
TYPE	_____
SPECIFIER	_____
QUANTITY	_____
DATE	_____

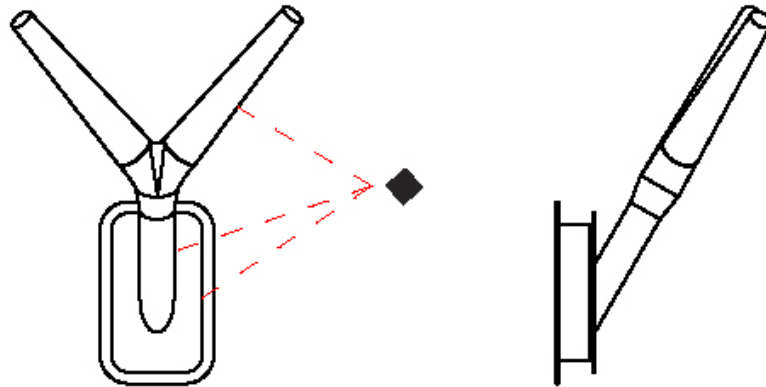

## SPARKS TRIPLE HEAD SURFACE

### D103136-

base number \_\_\_\_\_  
 Finish \_\_\_\_\_  
 Options \_\_\_\_\_

- To build a product code in our configurator select the specify button on the base model # product page
- To build a manual product code on this datasheet choose from the options listed below in blue font and add the suffix to the base model #

#### GENERAL

Series: Sparks \_\_\_\_\_  
 Subseries: Sparks Triple Head \_\_\_\_\_  
 Brand: Quasar \_\_\_\_\_  
 Division: Design \_\_\_\_\_  
 Mounting Type: Surface \_\_\_\_\_  
 Mounting Location: Wall \_\_\_\_\_  
 Subcategory: Ambient \_\_\_\_\_

#### PHYSICAL

Shape: Abstract \_\_\_\_\_  
 Length (mm): 270 \_\_\_\_\_  
 Length (in): 10 <sup>5</sup>/<sub>8</sub> \_\_\_\_\_  
 Height (mm): 340 \_\_\_\_\_  
 Depth (mm): 290 \_\_\_\_\_  
 Height (in): 13 <sup>3</sup>/<sub>8</sub> \_\_\_\_\_  
 Depth (in): 11 <sup>1</sup>/<sub>16</sub> \_\_\_\_\_  
 Light Distribution: Omnidirectional \_\_\_\_\_  
 Weight (kg): 3 \_\_\_\_\_  
 Weight (lbs): 6.6 \_\_\_\_\_  
 Fixture Finish: WHI / PAL \_\_\_\_\_  
 Fixture Material: Metal \_\_\_\_\_

#### ELECTRICAL

Lamp Type: LED \_\_\_\_\_  
 Input Wattage (W): 4.2 \_\_\_\_\_  
 Total Output Wattage (W): 1.2 \_\_\_\_\_  
 Dimming: Non-Dimmable \_\_\_\_\_  
 Driver Included: Yes \_\_\_\_\_  
 Driver Location: Integrated \_\_\_\_\_  
 Driver Type: Constant Current - Universal \_\_\_\_\_  
 Driver Class: Class 2 \_\_\_\_\_  
 Input Voltage (V): 120 - 277 \_\_\_\_\_  
 Constant Current (MA): 350 \_\_\_\_\_  
 Upon Request: (Not included - see components) Remote: 0-10Vdc dimming / Phase dimming @120Vac only

#### LED

Number of LEDs: 1 \_\_\_\_\_  
 Color Temperature (°K): 2700 \_\_\_\_\_  
 Max. Delivered Lumen (lm): 376 \_\_\_\_\_  
 CRI: >90 CRI \_\_\_\_\_  
 Lamp Life (hrs): 50000 \_\_\_\_\_

#### OPTICAL

#### RATINGS AND CERTIFICATIONS

Certified By: Certified for North American Standards \_\_\_\_\_  
 IP rating: IP20 \_\_\_\_\_

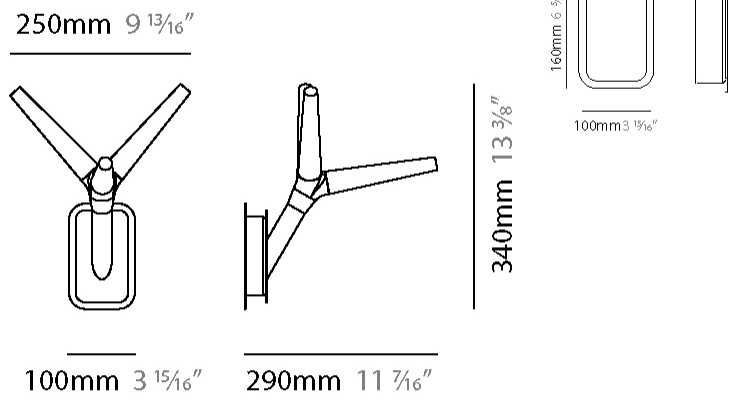

## SPARKS TRIPLE HEAD SURFACE

D103136-

PROJECT	_____
TYPE	_____
SPECIFIER	_____
QUANTITY	_____
DATE	_____

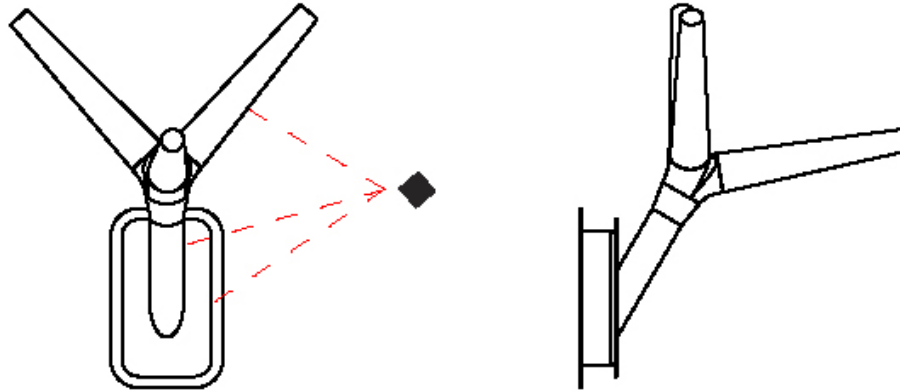

## SPARKS 7 SURFACE

**D103142-** \_\_\_\_\_ - \_\_\_\_\_

base number      LED Dimming      Finish Options

PROJECT	_____
TYPE	_____
SPECIFIER	_____
QUANTITY	_____
DATE	_____

- To build a product code in our configurator select the specify button on the base model # product page
- To build a manual product code on this datasheet choose from the options listed below in blue font and add the suffix to the base model #

### GENERAL

Series: Sparks  
 Subseries: Sparks 7  
 Brand: Quasar  
 Division: Design  
 Mounting Type: Surface  
 Mounting Location: Wall  
 Subcategory: Ambient

### PHYSICAL

Shape: Abstract  
 Length (mm): 1100  
 Length (in): 43 <sup>5</sup>/<sub>16</sub>  
 Height (mm): 1800  
 Depth (mm): 900  
 Height (in): 70 <sup>7</sup>/<sub>8</sub>  
 Depth (in): 35 <sup>7</sup>/<sub>16</sub>  
 Light Distribution: Omnidirectional  
 Fixture Finish: WHI / PAL  
 Fixture Material: Metal

### ELECTRICAL

Lamp Type: LED  
 Input Wattage (W): 32.2  
 Total Output Wattage (W): 22.4  
 Dimming: Non-Dimming / Phase Dimming (120Vac only) / 0-10V Dimming  
 Driver Included: Yes  
 Driver Location: Integrated  
 Driver Type: Constant Voltage - Universal  
 Driver Class: Class 2  
 Input Voltage (V): 120 - 277  
 Output Voltage (V): 24

### LED

Number of LEDs: 7  
 Color Temperature (°K): 2700  
 Max. Delivered Lumen (lm): 2632  
 CRI: >90 CRI  
 Lamp Life (hrs): 50000

### OPTICAL

### RATINGS AND CERTIFICATIONS

Certified By: Certified for North American Standards  
 IP rating: IP20

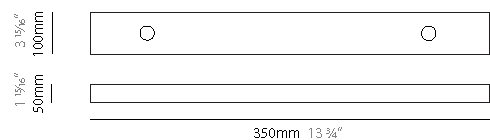
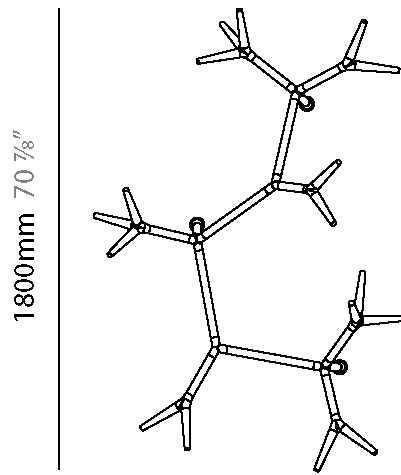
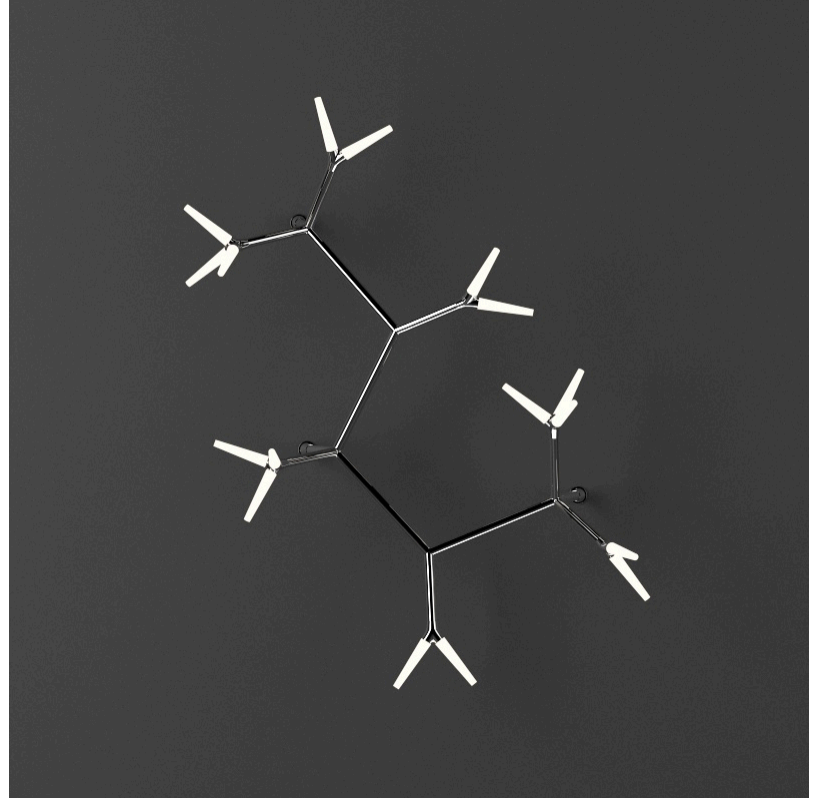

## SPARKS 7 SURFACE

D103142-

PROJECT	_____
TYPE	_____
SPECIFIER	_____
QUANTITY	_____
DATE	_____

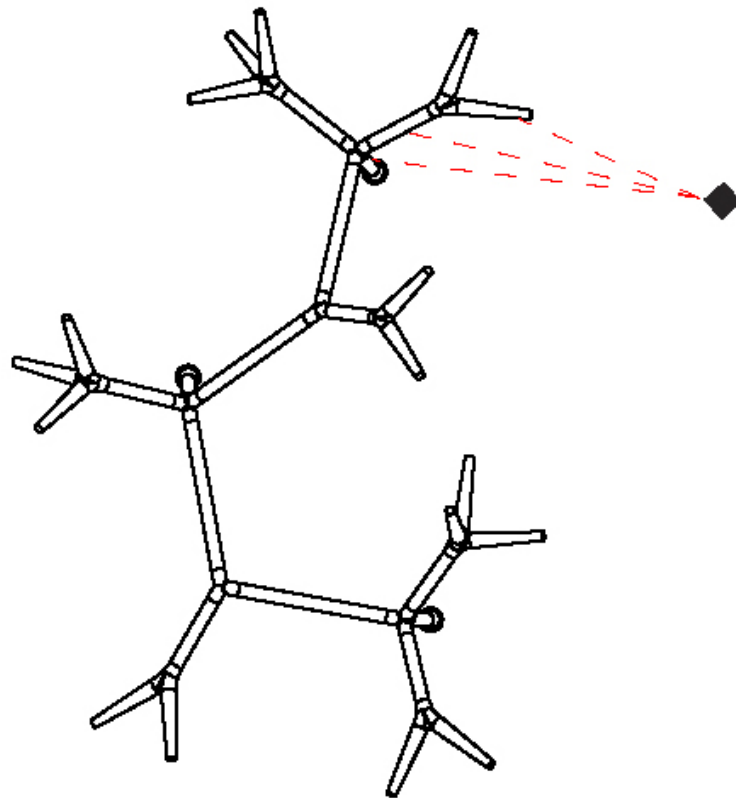

D



PROJECT	_____
TYPE	_____
SPECIFIER	_____
QUANTITY	_____
DATE	_____

## SPARKS 9 SURFACE

### D103143-

base number	LED Dimming	Finish Options
-------------	-------------	----------------

- To build a product code in our configurator select the specify button on the base model # product page
- To build a manual product code on this datasheet choose from the options listed below in blue font and add the suffix to the base model #

#### GENERAL

Series: Sparks
Subseries: Sparks 9
Brand: Quasar
Division: Design
Mounting Type: Surface
Mounting Location: Wall
Subcategory: Ambient

#### PHYSICAL

Shape: Abstract
Length (mm): 1200
Length (in): 47 1/4
Height (mm): 2400
Depth (mm): 900
Height (in): 94 1/2
Depth (in): 35 7/16
Light Distribution: Omnidirectional
Fixture Finish: WHI / PAL
Fixture Material: Metal

#### ELECTRICAL

Lamp Type: LED
Input Wattage (W): 41.4
Total Output Wattage (W): 28.8
Dimming: Non-Dimming / Phase Dimming (120Vac only) / 0-10V Dimming
Driver Included: Yes
Driver Location: Integrated
Driver Type: Constant Voltage - Universal
Driver Class: Class 2
Input Voltage (V): 120 - 277
Output Voltage (V): 24

#### LED

Number of LEDs: 9
Color Temperature (°K): 2700
Max. Delivered Lumen (lm): 3384
CRI: >90 CRI
Lamp Life (hrs): 50000

#### OPTICAL

#### RATINGS AND CERTIFICATIONS

Certified By: Certified for North American Standards
IP rating: IP20

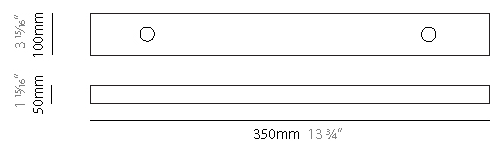
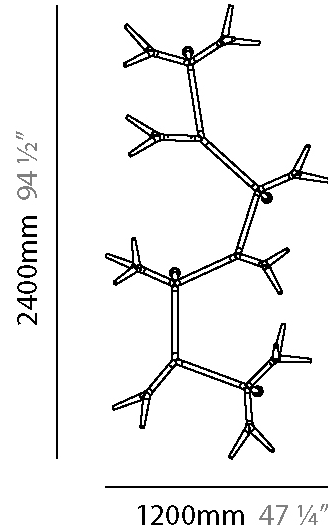
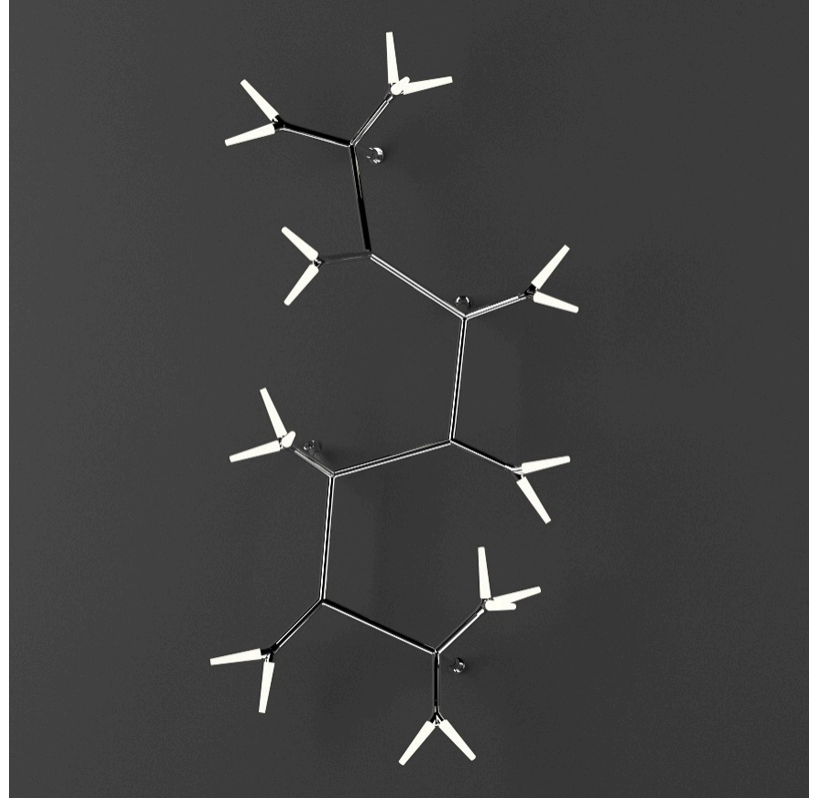

## SPARKS 9 SURFACE

D103143-

PROJECT

TYPE

SPECIFIER

QUANTITY

DATE

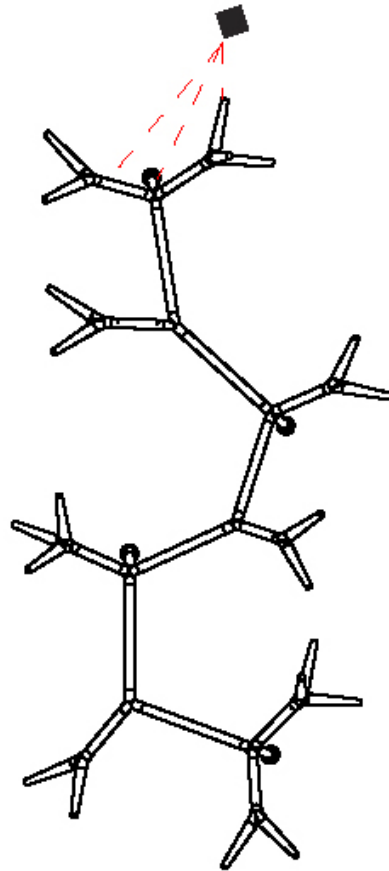

D

## SPARKS 11 SURFACE

### D103145-

base number      LED      Finish  
 Dimming      Options

- To build a product code in our configurator select the specify button on the base model # product page
- To build a manual product code on this datasheet choose from the options listed below in blue font and add the suffix to the base model #

#### GENERAL

Series: Sparks  
 Subseries: Sparks 11  
 Brand: Quasar  
 Division: Design  
 Mounting Type: Surface  
 Mounting Location: Wall  
 Subcategory: Ambient

#### PHYSICAL

Shape: Abstract  
 Length (mm): 1700  
 Length (in): 66 <sup>15</sup>/<sub>16</sub>  
 Height (mm): 2600  
 Depth (mm): 900  
 Height (in): 102 <sup>3</sup>/<sub>8</sub>  
 Depth (in): 35 <sup>7</sup>/<sub>16</sub>  
 Light Distribution: Omnidirectional  
 Fixture Finish: WHI / PAL  
 Fixture Material: Metal

#### ELECTRICAL

Lamp Type: LED  
 Input Wattage (W): 50.6  
 Total Output Wattage (W): 35.2  
 Dimming: Non-Dimming / Phase Dimming (120Vac only) / 0-10V Dimming  
 Driver Included: Yes  
 Driver Location: Integrated  
 Driver Type: Constant Voltage - Universal  
 Driver Class: Class 2  
 Input Voltage (V): 120 - 277  
 Output Voltage (V): 24

#### LED

Number of LEDs: 11  
 Color Temperature (°K): 2700  
 Max. Delivered Lumen (lm): 4136  
 CRI: >90 CRI  
 Lamp Life (hrs): 50000

#### OPTICAL

#### RATINGS AND CERTIFICATIONS

Certified By: Certified for North American Standards  
 IP rating: IP20

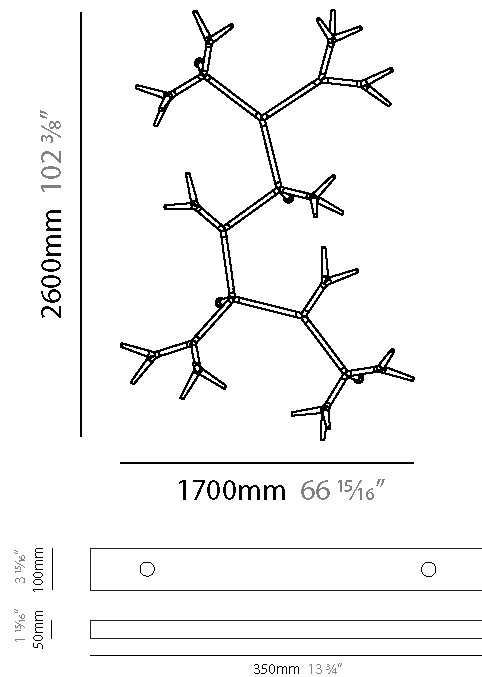
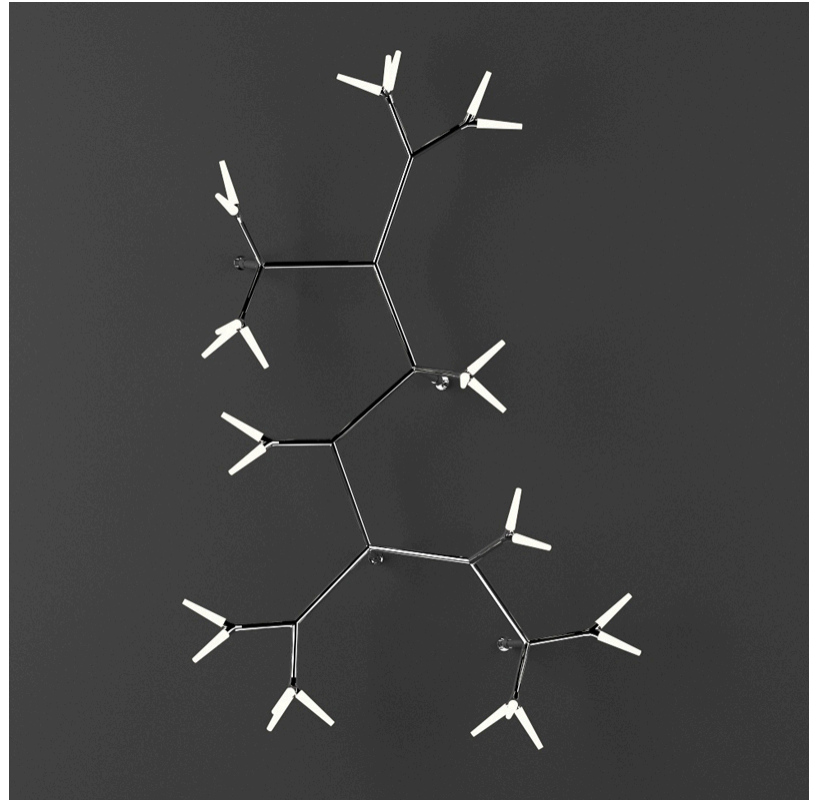

## SPARKS 11 SURFACE

D103145-

PROJECT

TYPE

SPECIFIER

QUANTITY

DATE

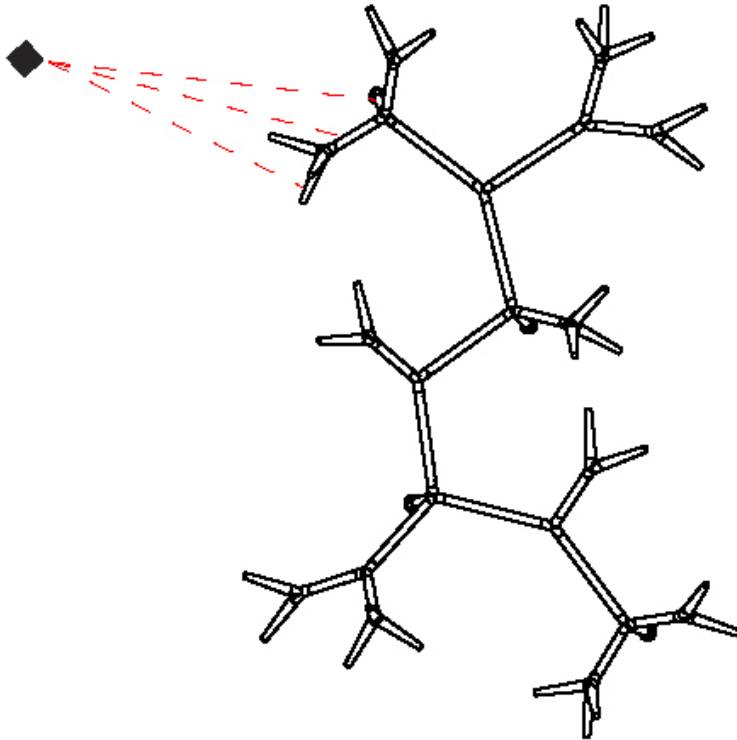

D

## SPARKS 15 SURFACE

### D103147-

base number      LED Dimming      Finish Options

PROJECT
TYPE
SPECIFIER
QUANTITY
DATE

- To build a product code in our configurator select the specify button on the base model # product page
- To build a manual product code on this datasheet choose from the options listed below in blue font and add the suffix to the base model #

#### GENERAL

Series: Sparks  
 Subseries: Sparks 15  
 Brand: Quasar  
 Division: Design  
 Mounting Type: Surface  
 Mounting Location: Wall  
 Subcategory: Ambient

#### PHYSICAL

Shape: Abstract  
 Length (mm): 1900  
 Length (in): 74 <sup>13</sup>/<sub>16</sub>  
 Height (mm): 3340  
 Depth (mm): 900  
 Height (in): 131 <sup>1</sup>/<sub>2</sub>  
 Depth (in): 35 <sup>7</sup>/<sub>16</sub>  
 Light Distribution: Omnidirectional  
 Weight (kg): 17  
 Weight (lbs): 37.48  
 Fixture Finish: WHI / PAL  
 Fixture Material: Metal

#### ELECTRICAL

Lamp Type: LED  
 Input Wattage (W): 69  
 Total Output Wattage (W): 48  
 Dimming: Non-Dimming / Phase Dimming (120Vac only) / 0-10V Dimming  
 Driver Included: Yes  
 Driver Location: Integrated  
 Driver Type: Constant Voltage - Universal  
 Driver Class: Class 2  
 Input Voltage (V): 120 - 277  
 Output Voltage (V): 24

#### LED

Number of LEDs: 15  
 Color Temperature (°K): 2700  
 Max. Delivered Lumen (lm): 5640  
 CRI: >90 CRI  
 Lamp Life (hrs): 50000

#### OPTICAL

#### RATINGS AND CERTIFICATIONS

Certified By: Certified for North American Standards  
 IP rating: IP20

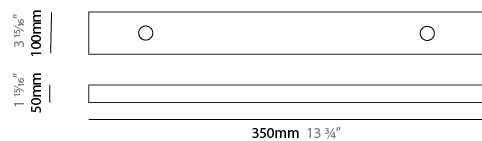
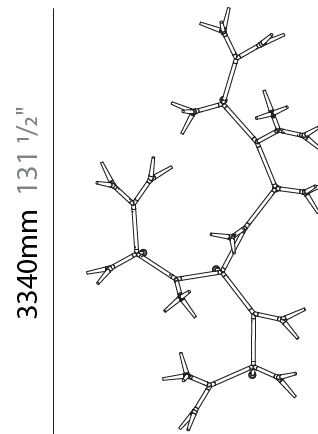
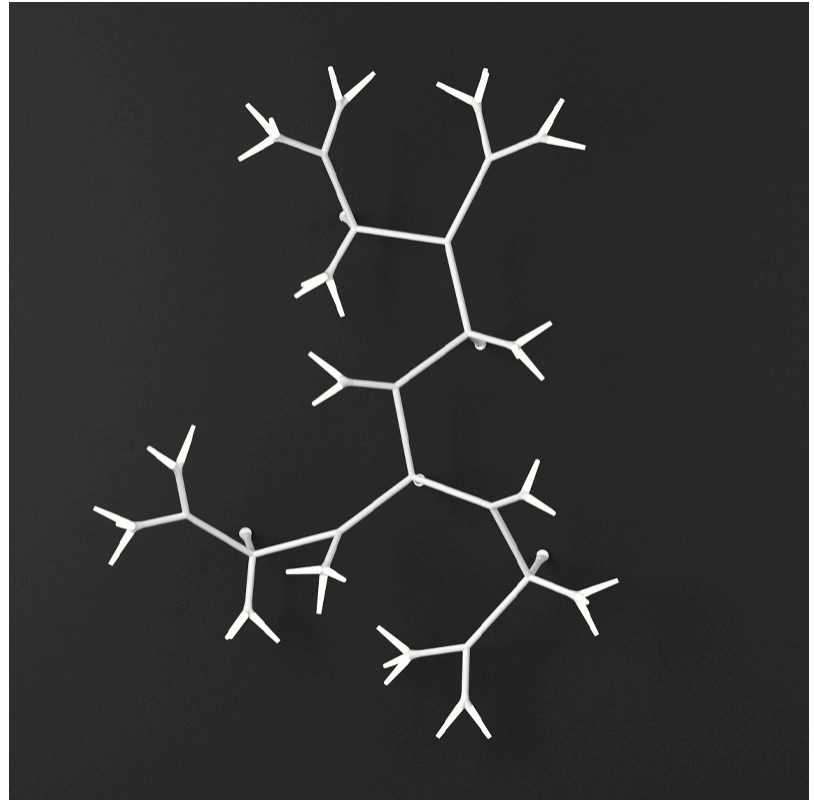

D103147-

PROJECT

TYPE

SPECIFIER

QUANTITY

DATE

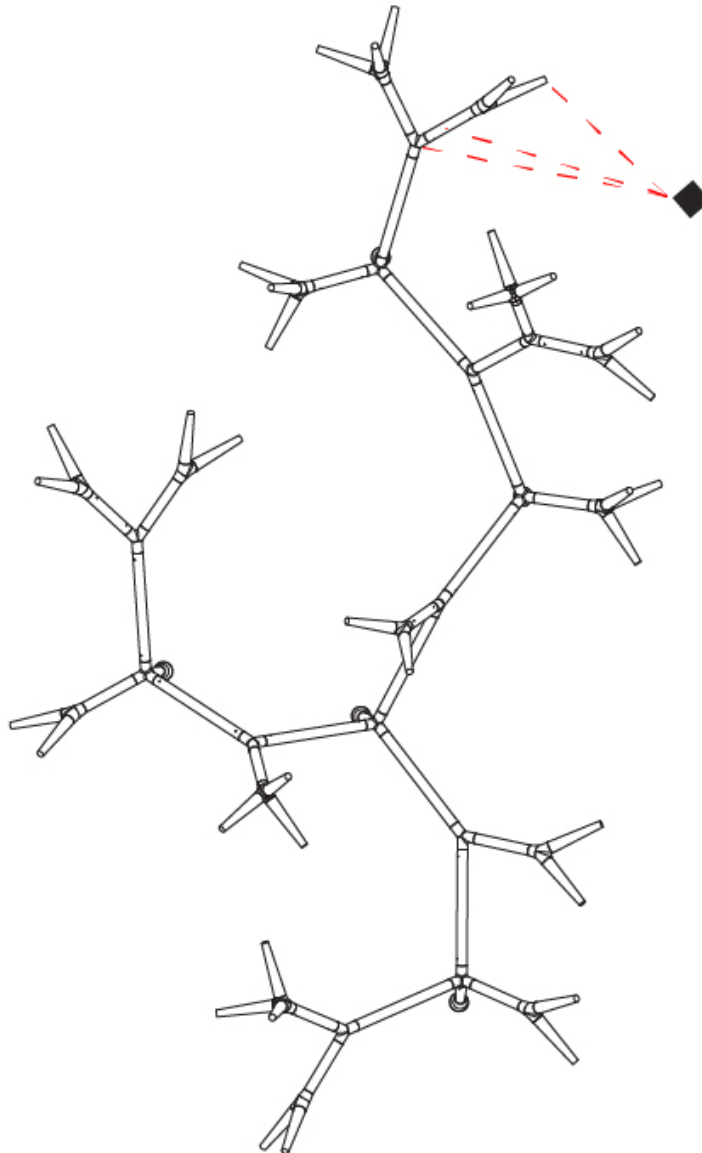

D

## SPARKS 17 SURFACE

### D103148-

base number      LED Dimming      Finish Options

- To build a product code in our configurator select the specify button on the base model # product page
- To build a manual product code on this datasheet choose from the options listed below in blue font and add the suffix to the base model #

#### GENERAL

Series: Sparks  
 Subseries: Sparks 17  
 Brand: Quasar  
 Division: Design  
 Mounting Type: Surface  
 Mounting Location: Wall  
 Subcategory: Ambient

#### PHYSICAL

Shape: Abstract  
 Length (mm): 2590  
 Length (in): 101 <sup>15</sup>/<sub>16</sub>  
 Height (mm): 3250  
 Depth (mm): 900  
 Height (in): 127 <sup>15</sup>/<sub>16</sub>  
 Depth (in): 35 <sup>7</sup>/<sub>16</sub>  
 Light Distribution: Omnidirectional  
 Weight (kg): 21  
 Weight (lbs): 46.30  
 Fixture Finish: WHI / PAL  
 Fixture Material: Metal

#### ELECTRICAL

Lamp Type: LED  
 Input Wattage (W): 78.2  
 Total Output Wattage (W): 54.4  
 Dimming: Non-Dimming / Phase Dimming (120Vac only) / 0-10V Dimming  
 Driver Included: Yes  
 Driver Location: Integrated  
 Driver Type: Constant Voltage - Universal  
 Driver Class: Class 2  
 Input Voltage (V): 120 - 277  
 Output Voltage (V): 24

#### LED

Number of LEDs: 17  
 Color Temperature (°K): 2700  
 Max. Delivered Lumen (lm): 6392  
 CRI: >90 CRI  
 Lamp Life (hrs): 50000

#### OPTICAL

#### RATINGS AND CERTIFICATIONS

Certified By: Certified for North American Standards  
 IP rating: IP20

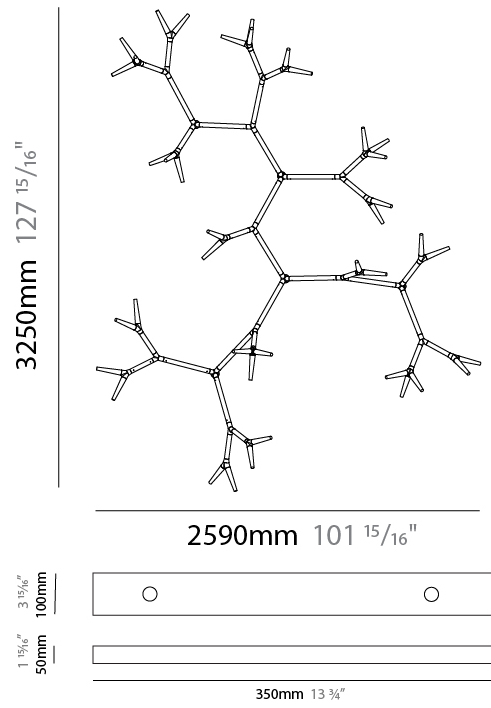
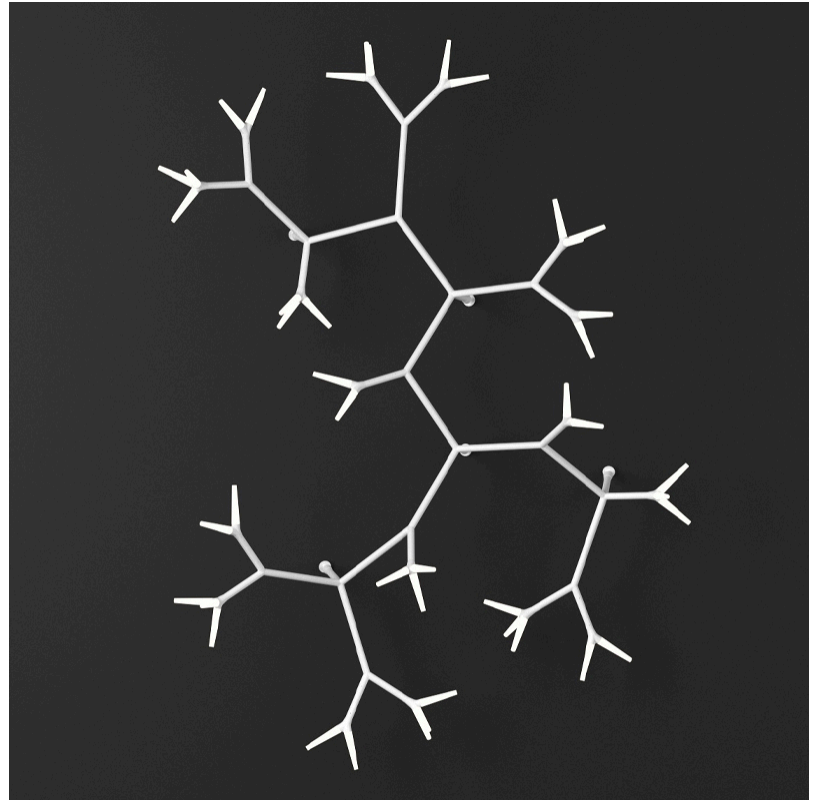

## SPARKS 17 SURFACE

D103148-

PROJECT

TYPE

SPECIFIER

QUANTITY

DATE

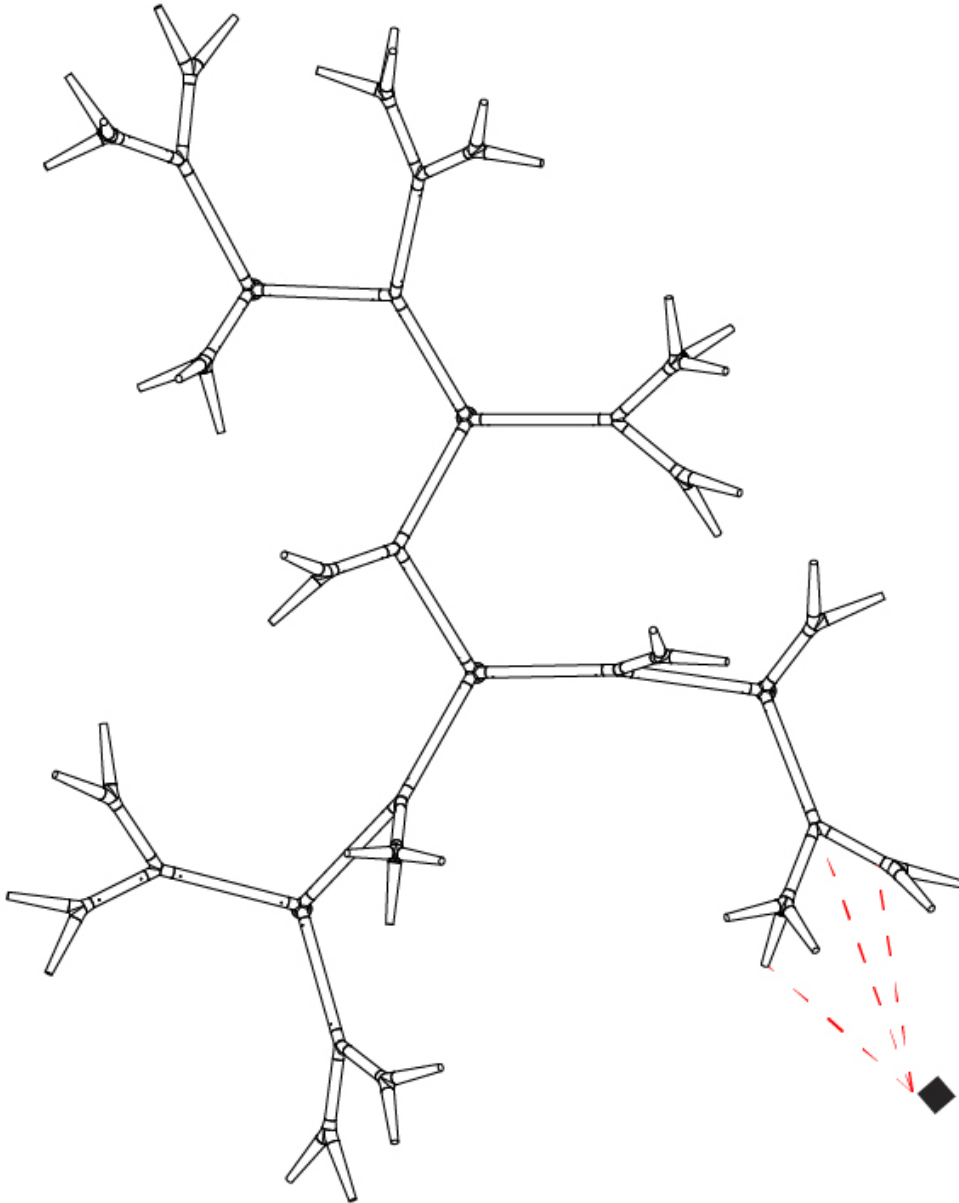

D



PROJECT	
TYPE	
SPECIFIER	
QUANTITY	
DATE	

## SPARKS 19 SURFACE

### D103149-

base number	LED Dimming	Finish Options
-------------	-------------	----------------

- To build a product code in our configurator select the specify button on the base model # product page
- To build a manual product code on this datasheet choose from the options listed below in blue font and add the suffix to the base model #

#### GENERAL

Series: Sparks
Subseries: Sparks 19
Brand: Quasar
Division: Design
Mounting Type: Surface
Mounting Location: Wall
Subcategory: Ambient

#### PHYSICAL

Shape: Abstract
Length (mm): 1880
Length (in): 74
Height (mm): 5300
Depth (mm): 900
Height (in): 208 <sup>11</sup> / <sub>16</sub>
Depth (in): 35 <sup>7</sup> / <sub>16</sub>
Light Distribution: Omnidirectional
Weight (kg): 24
Weight (lbs): 52.91
Fixture Finish: WHI / PAL
Fixture Material: Metal

#### ELECTRICAL

Lamp Type: LED
Input Wattage (W): 87.4
Total Output Wattage (W): 60.8
Dimming: 0-10V Dimming / Phase Dimming (120Vac Only)
Driver Included: Yes
Driver Location: Integrated
Driver Type: Constant Voltage - Universal
Driver Class: Class 2
Input Voltage (V): 120 - 277
Output Voltage (V): 24

#### LED

Number of LEDs: 19
Color Temperature (°K): 2700
Max. Delivered Lumen (lm): 7144
CRI: >90 CRI
Lamp Life (hrs): 50000

#### OPTICAL

#### RATINGS AND CERTIFICATIONS

Certified By: Certified for North American Standards
IP rating: IP20

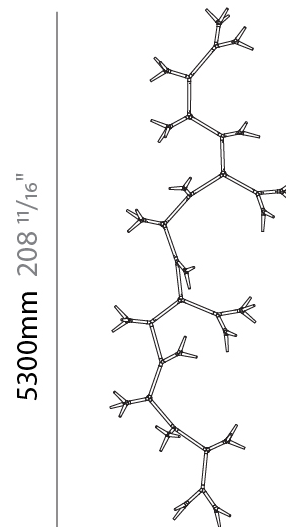
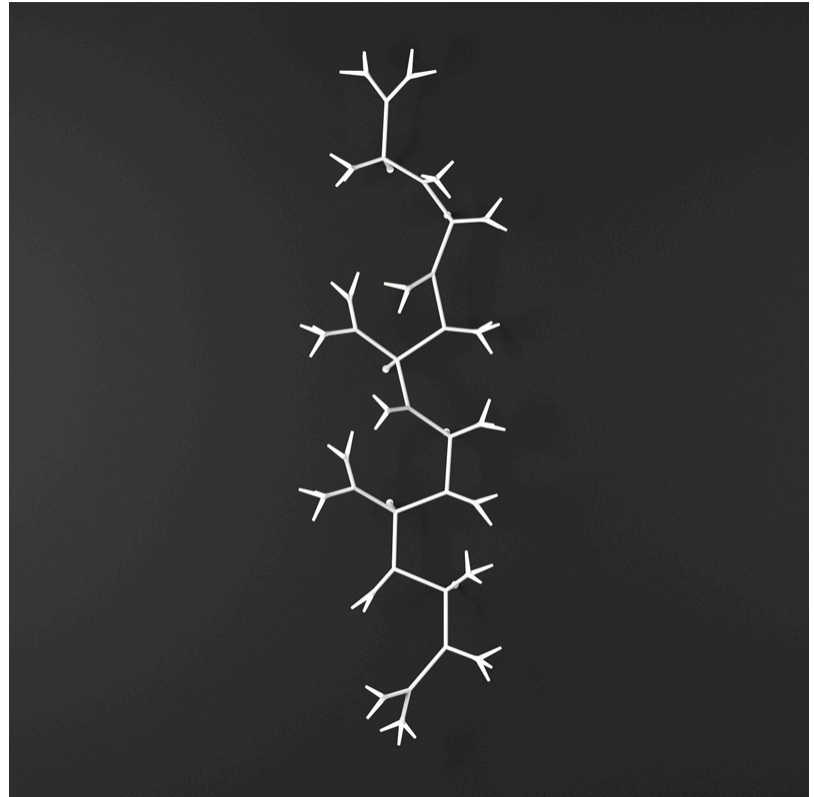

1880mm 74"



## SPARKS 19 SURFACE

D103149-

PROJECT

TYPE

SPECIFIER

QUANTITY

DATE

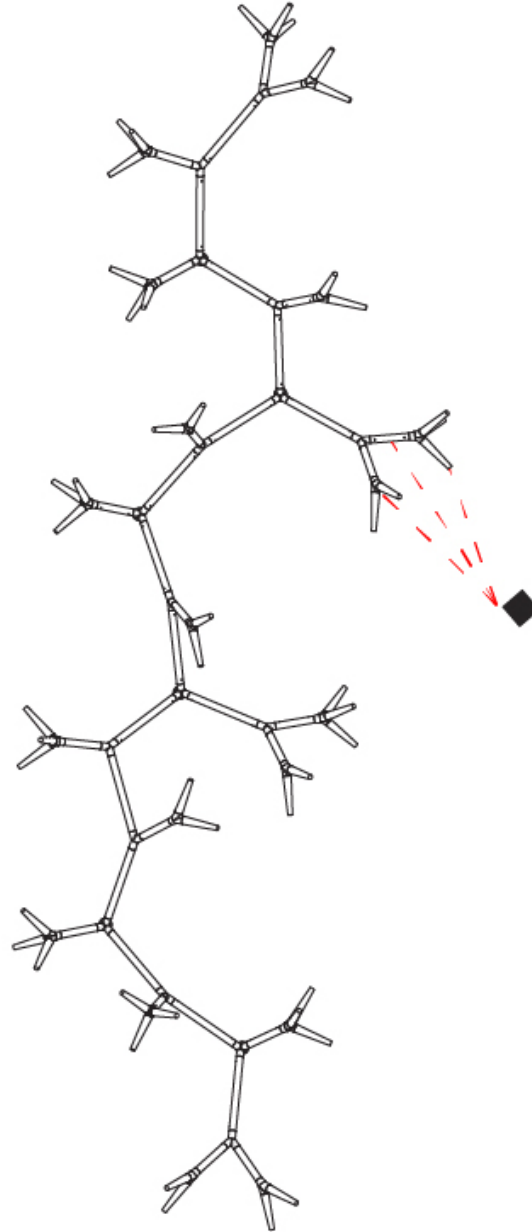

D

PROJECT	_____
TYPE	_____
SPECIFIER	_____
QUANTITY	_____
DATE	_____

## SPARKS MODULAR SYSTEM SURFACE

### D10SP-MOD-SYS

base number

1. To build a product code in our configurator select the specify button on the base model # product page
2. To build a manual product code on this datasheet choose from the options listed below in blue font and add the suffix to the base model #

#### GENERAL

Series: Sparks  
Subseries: Sparks Modular System  
Brand: Quasar  
Division: Design  
Mounting Type: Surface  
Mounting Location: Ceiling  
Subcategory: Modular

#### PHYSICAL

Shape: Abstract  
Light Distribution: Omnidirectional  
Fixture Finish: WHI / PAL  
Fixture Material: Metal

#### ELECTRICAL

Lamp Type: LED  
Dimming: Non-Dimming / Phase Dimming (120Vac only) / 0-10V Dimming  
Driver Included: No  
Driver Location: Remote  
Driver Type: Constant Voltage - Universal  
Driver Class: Class 2  
Input Voltage (V): 120 - 277  
Output Voltage (V): 24

#### LED

Color Temperature (°K): 2700  
CRI: >90 CRI  
Lamp Life (hrs): 50000

#### OPTICAL

#### RATINGS AND CERTIFICATIONS

Certified By: Certified for North American Standards  
IP rating: IP20

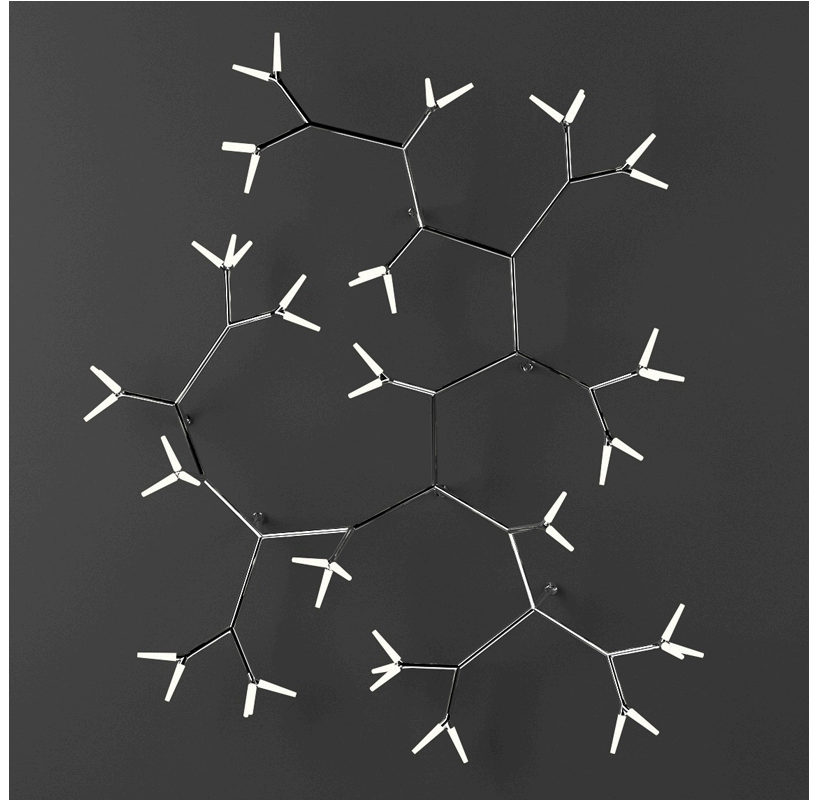

PROJECT \_\_\_\_\_

TYPE \_\_\_\_\_

SPECIFIER \_\_\_\_\_

QUANTITY \_\_\_\_\_

DATE \_\_\_\_\_

### Fixture Finish

White - WHI



Polished Aluminum - PAL

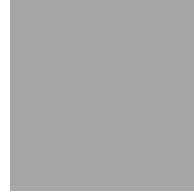

**Digital:** Not all screens are calibrated the same, and therefore, colors will appear differently between screens.

**Physical:** When texture is involved, there will be variations in color, character and tone within a product series and between product families.



### LEGEND

	floor-mounted		pivotal		special LED (upon request) RGB, RGBW, tunable, gold+, meat+, art+, fashion+
	wall and ceiling: recessed and surface mounted		rotating		warm dim / natural dimming LED
	ceiling-mounted and wall-mounted		illuminate tilted		rechargeable battery powered
	wall-mounted		color of suspension cable		fixture with natural vivid LED (upon request)
	omni-directional light distribution		length of suspension cable		color rendering index
	direct light distribution		reflector degree selection		color temperature
	direct/indirect light distribution		super spot		lumen (luminous flux)
	indirect light distribution		lens		efficacy (lumens per watt)
	asymmetric light distribution		lens pack		Unified Glare Rating (UGR) range from 5-40
	aura light distribution		shine ring		marine grade (AISI 316 stainless steel)
	round wall or ceiling cut-out		integrated shine ring with diffuser		walk on
	square wall or ceiling cut-out		free individual colors 01-29		drive on
	the supplied jig specifies the cutout dimensions		individual colors: 00 (free of charge), 01-25 (extra charge)		Dark Sky Compliance
	minimum distance (meters) lamp - object		luminaire part to be colored (F1)		Americans with Disabilities Act (less than 4" off the wall located between 27"-84" from floor)
	recessed depth		luminaire part to be colored (F2)		lamp protected against explosion
	ceiling thickness in mm		luminaire part to be colored (F3)		blown glass using traditional methods by master glass blower
	ceiling thickness selection		luminaire part to be colored (F4)		acoustic material
	dimmable DP (phase), DV (0-10V), DD (dali), DS (step-dim)		luminaire part to be colored (F5)		protection class I, protection insulation
	included or excluded LED driver/transformer/control gear		color of 3-circuit adaptor		protection class II, protection insulation
	separately switchable		indirect diffuser		ETL Certified to UL and CSA Standards
	sensor		direct diffuser		UL Certified to UL and CSA Standards
	remote control		ball-proof (upon request)		CSA Certified to UL and CSA Standards
	available upon request		accessory		Certified for North American Standards

### IP RATING

	protected against ingress of solid bodies greater than 12.5mm (finger)
	protected against ingress of solid bodies greater than 2.5mm protected against sprays of water up to 60 degrees from the vertical (rain)
	protected against ingress of solid bodies greater than 1mm (wire) no protection against the ingress of moisture
	protected against ingress of solid bodies greater than 1mm (wire) protected against sprays of water up to 60 degrees from the vertical (rain)
	protected against ingress of solid bodies greater than 1mm (wire) protected against water splashed from all directions
	protected against limited ingress of dust (wet rooms/covered outdoor areas) protected against water splashed from all directions
	protected against ingress of dust protected against jets of water
	protected against ingress of dust protected against powerful jets of water or heavy seas
	protected against ingress of dust protected against immersion of water between 15cm - 1m for 30 minutes
	protected against ingress of dust protected against immersion of water under pressure for long periods

### IK RATING

	protected against 0.14 joules impact (equivalent to 0.25kg mass dropped from 56mm above the surface)
	protected against 0.2 joules impact (equivalent to 0.25kg mass dropped from 80mm above the surface)
	protected against 0.35 joules impact (equivalent to 0.25kg mass dropped from 140mm above the surface)
	protected against 0.5 joules impact (equivalent to 0.25kg mass dropped from 200mm above the surface)
	protected against 0.7 joules impact (equivalent to 0.25kg mass dropped from 280mm above the surface)
	protected against 1 joules impact (equivalent to 0.25kg mass dropped from 400mm above the surface)
	protected against 2 joules impact (equivalent to 0.5kg mass dropped from 400mm above the surface)
	protected against 5 joules impact (equivalent to 1.7kg mass dropped from 300mm above the surface)
	protected against 10 joules impact (equivalent to 5.0kg mass dropped from 200mm above the surface)
	protected against 20 joules impact (equivalent to 5.0kg mass dropped from 400mm above the surface)