

| | |
|-----------|--|
| PROJECT | |
| TYPE | |
| SPECIFIER | |
| QUANTITY | |
| DATE | |

SPICA 1 PENDANT SUSPENSION

D101527-

base number Finish
Options

- To build a product code in our configurator select the specify button on the base model # product page
- To build a manual product code on this datasheet choose from the options listed below in blue font and add the suffix to the base model #

GENERAL

Series: Spica
Subseries: Spica 1 Pendant
Brand: Quasar
Division: Design
Mounting Type: Suspension
Mounting Location: Ceiling

PHYSICAL

Shape: Abstract
Diameter (mm): 200
Diameter (in): 7 7/8
Height (mm): 150
Height (in): 5 7/8
Max. Overall Height (mm): 2150
Max. Overall Height (in): 84 5/8
Light Distribution: Direct
Weight (kg): 1
Weight (lbs): 2.2
Diffuser: Acrylic Shade - See Finish Options
[Fixture Finish: RED / ORG / YEL / GRN / BLU / TRA](#)
Fixture Material: Aluminum
Cable Details: 2000mm (78 3/4") Black Cable

ELECTRICAL

Lamp Type: LED
Total Output Wattage (W): 2.2
Dimming: Phase Dimming (120Vac Only)
Driver Included: No
Driver Location: Remote
Driver Type: Constant Current - 120 / 277Vac
Driver Class: Class 2
Input Voltage (V): 120 - 277
Constant Current (MA): 250
Upon Request: (Not included - see components) Phase dimming @120Vac only / Non-dimming @277Vac

LED

Number of LEDs: 1
Color Temperature (°K): 2700
Max. Delivered Lumen (lm): 150
CRI: >90 CRI
Lamp Life (hrs): 50000

OPTICAL

RATINGS AND CERTIFICATIONS

Certified By: Certified for North American Standards
IP rating: IP20



SPICA 1 PENDANT SUSPENSION

D101527-

PROJECT

TYPE

SPECIFIER

QUANTITY

DATE



D

| |
|-----------|
| PROJECT |
| TYPE |
| SPECIFIER |
| QUANTITY |
| DATE |

SPICA 1 PENDANT SUSPENSION

D101624-

base number Finish
Options

- To build a product code in our configurator select the specify button on the base model # product page
- To build a manual product code on this datasheet choose from the options listed below in blue font and add the suffix to the base model #

GENERAL

Series: Spica
 Subseries: Spica 1 Pendant
 Brand: Quasar
 Division: Design
 Mounting Type: Suspension
 Mounting Location: Ceiling
 Subcategory: Pendant

PHYSICAL

Shape: Abstract
 Diameter (mm): 200
 Diameter (in): 7 7/8
 Height (mm): 150
 Height (in): 5 7/8
 Max. Overall Height (mm): 2150
 Max. Overall Height (in): 84 5/8
 Light Distribution: Direct
 Weight (kg): 1
 Weight (lbs): 2.2
 Diffuser: Acrylic Shade – See Finish Options
 Fixture Finish: [RED](#) / [ORG](#) / [YEL](#) / [GRN](#) / [BLU](#) / [TRA](#)
 Fixture Material: Aluminum
 Cable Details: 2000mm (78 3/4") Black Cable

ELECTRICAL

Lamp Type: LED
 Total Output Wattage (W): 2.2
 Driver Included: No
 Driver Location: Remote
 Driver Type: Constant Current - 120 / 277Vac
 Driver Class: Class 2
 Input Voltage (V): 120 - 277
 Constant Current (MA): 250
 Upon Request: (Not included - see components) Remote: 0-10Vdc dimming / Phase dimming @120Vac only / Non-dimming 277Vac

LED

Color Temperature (°K): 2700
 Max. Delivered Lumen (lm): 150
 CRI: >90 CRI
 Lamp Life (hrs): 50000

OPTICAL

RATINGS AND CERTIFICATIONS

Certified By: Certified for North American Standards
 IP rating: IP20

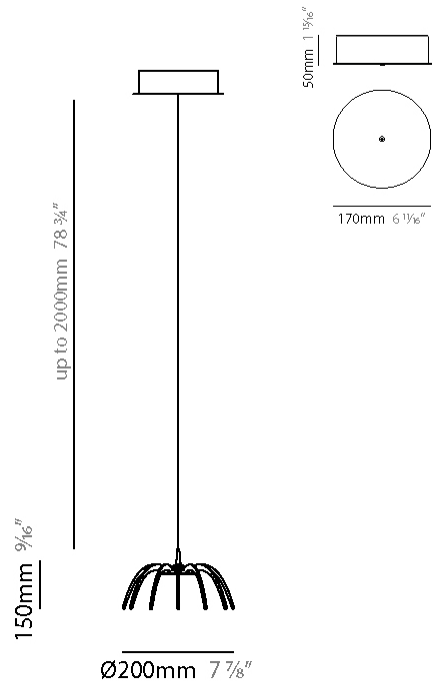

SPICA 1 PENDANT SUSPENSION

D101624-

PROJECT

TYPE

SPECIFIER

QUANTITY

DATE



D

SPICA 3 PENDANT SUSPENSION

D101636-

base number Finish
Options

- To build a product code in our configurator select the specify button on the base model # product page
- To build a manual product code on this datasheet choose from the options listed below in blue font and add the suffix to the base model #

GENERAL

Series: Spica _____
Subseries: Spica 3 Pendant _____
Brand: Quasar _____
Division: Design _____
Mounting Type: Suspension _____
Mounting Location: Ceiling _____

PHYSICAL

Shape: Abstract _____
Diameter (mm): 300 _____
Diameter (in): 11 ¹³/₁₆ _____
Length (mm): 1200 _____
Length (in): 47 ¹/₄ _____
Height (mm): 150 _____
Height (in): 5 ⁷/₈ _____
Max. Overall Height (mm): 2150 _____
Max. Overall Height (in): 84 ⁵/₈ _____
Light Distribution: Direct _____
Weight (kg): 5 _____
Weight (lbs): 11.02 _____
Diffuser: Acrylic Shade – See Finish Options _____
Fixture Finish: [RED](#) / [ORG](#) / [YEL](#) / [GRN](#) / [BLU](#) / [TRA](#) _____
Fixture Material: Aluminum _____
Cable Details: 2000mm (78 3/4") Black Cable _____

ELECTRICAL

Lamp Type: LED _____
Total Output Wattage (W): 6.6 _____
Dimming: Phase Dimming (120Vac Only) _____
Driver Included: Yes _____
Driver Location: Integrated _____
Driver Type: Constant Current - 120Vac _____
Driver Class: Class 2 _____
Input Voltage (V): 120 - 277 _____
Constant Current (MA): 250 _____
Upon Request: (Not included - see components) Integral: Phase dimming @120Vac only / Non-dimming @277Vac _____

LED

Color Temperature (°K): 2700 _____
Max. Delivered Lumen (lm): 450 _____
CRI: >90 CRI _____
Lamp Life (hrs): 50000 _____

OPTICAL

RATINGS AND CERTIFICATIONS

Certified By: Certified for North American Standards _____
IP rating: IP20 _____

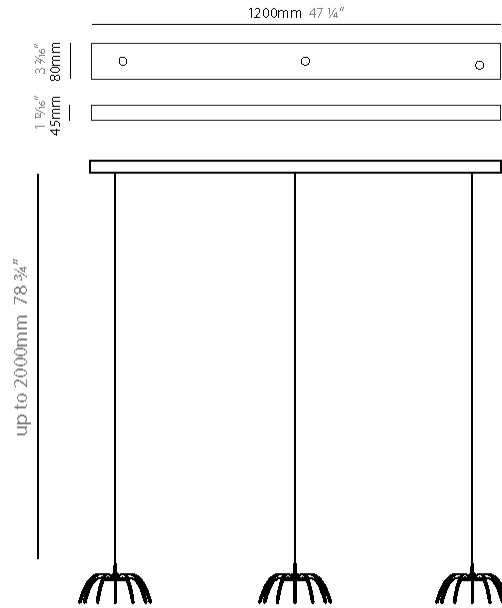

SPICA 3 PENDANT SUSPENSION

D101636-

PROJECT

TYPE

SPECIFIER

QUANTITY

DATE

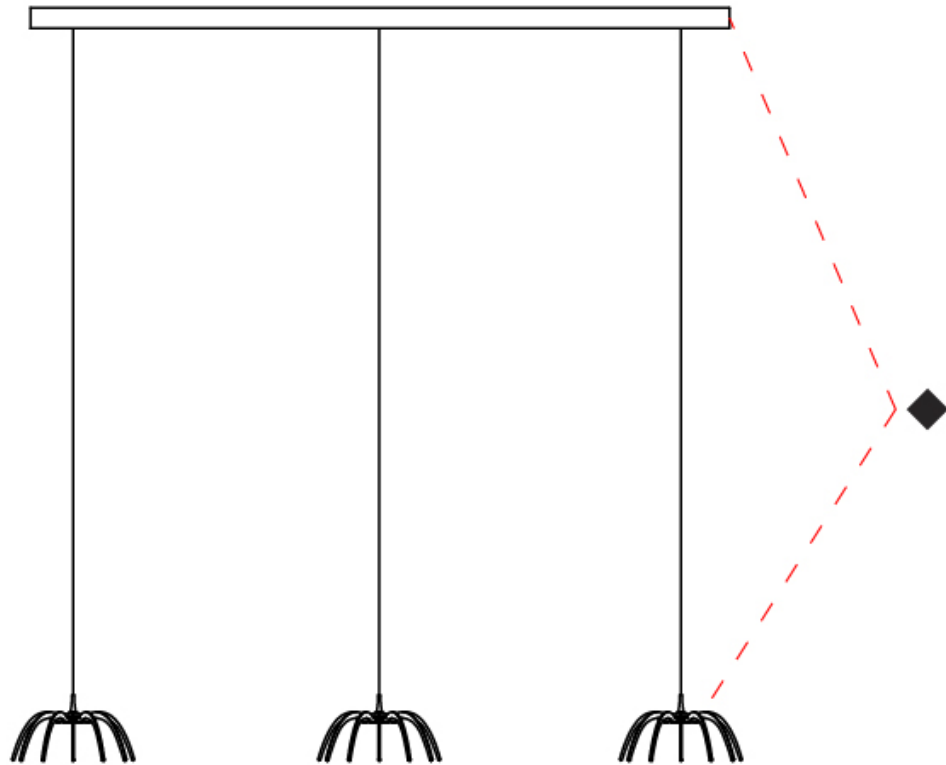

D

| | |
|-----------|--|
| PROJECT | |
| TYPE | |
| SPECIFIER | |
| QUANTITY | |
| DATE | |

SPICA 7 PENDANT SUSPENSION

D101695

base number

- To build a product code in our configurator select the specify button on the base model # product page
- To build a manual product code on this datasheet choose from the options listed below in blue font and add the suffix to the base model #

GENERAL

Series: Spica
 Subseries: Spica 7 Pendant
 Brand: Quasar
 Division: Design
 Mounting Type: Suspension
 Mounting Location: Ceiling

PHYSICAL

Shape: Abstract
 Diameter (mm): 600
 Diameter (in): 23 5/8
 Height (mm): 150
 Height (in): 5 7/8
 Max. Overall Height (mm): 2150
 Max. Overall Height (in): 84 5/8
 Light Distribution: Direct
 Diffuser: Acrylic Shade – See Finish Options
 Fixture Finish: RED / ORG / YEL / GRN / BLU / TRA
 Fixture Material: Aluminum
 Cable Details: 2000mm (78 3/4") Black Cable

ELECTRICAL

Lamp Type: LED
 Total Output Wattage (W): 15.4
 Max. Wattage Per Lamp (W): 2.2
 Dimming: Phase Dimming (120Vac Only)
 Driver Included: Yes
 Driver Location: Integrated
 Driver Type: Constant Current - 120Vac
 Driver Class: Class 2
 Input Voltage (V): 120 - 277
 Constant Current (MA): 250
 Upon Request: (Not included - see components) Integral: Phase dimming @120Vac only / Non-dimming @277Vac

LED

Number of LEDs: 7
 Color Temperature (°K): 2700
 Max. Delivered Lumen (lm): 1050
 CRI: >90 CRI
 Lamp Life (hrs): 50000

OPTICAL

RATINGS AND CERTIFICATIONS

Certified By: Certified for North American Standards
 IP rating: IP20

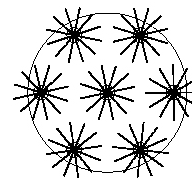
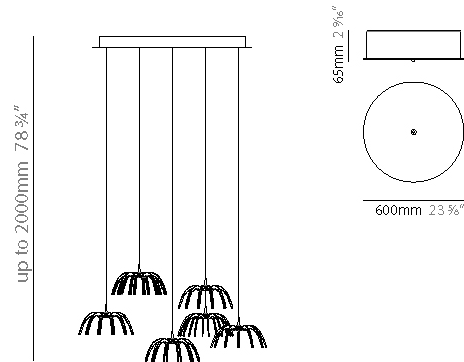

Ø600mm 23 5/8"



SPICA 7 PENDANT SUSPENSION

D101695

PROJECT

TYPE

SPECIFIER

QUANTITY

DATE

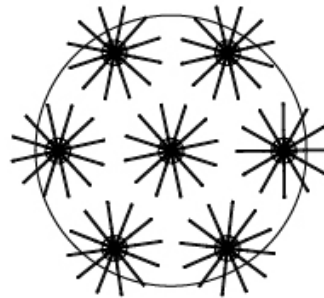
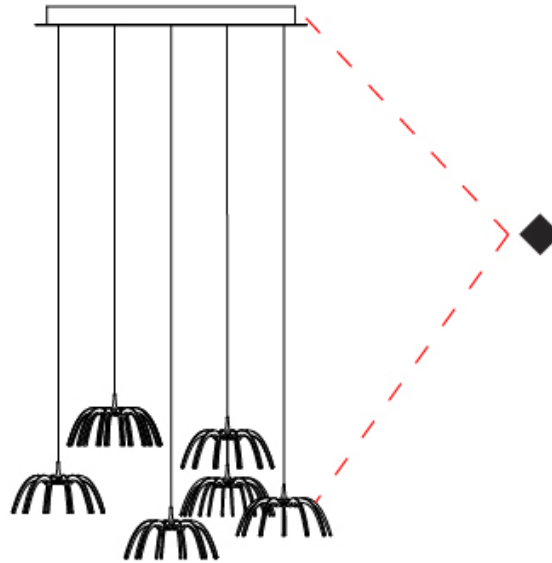

D

| | |
|-----------|-------|
| PROJECT | _____ |
| TYPE | _____ |
| SPECIFIER | _____ |
| QUANTITY | _____ |
| DATE | _____ |

Fixture Finish

Red - RED



Orange - ORG



Yellow - YEL



Green - GRN



Blue - BLU



Transparent - TRA



Digital: Not all screens are calibrated the same, and therefore, colors will appear differently between screens.

Physical: When texture is involved, there will be variations in color, character and tone within a product series and between product families.



| | |
|-----------|--|
| PROJECT | |
| TYPE | |
| SPECIFIER | |
| QUANTITY | |
| DATE | |

LEGEND

| | | |
|---|--|--|
| floor-mounted | pivotal | special LED (upon request) RGB, RGBW, tunable, gold+, meat+, art+, fashion+ |
| wall and ceiling: recessed and surface mounted | rotating | warm dim / natural dimming LED |
| ceiling-mounted and wall-mounted | illuminate tilted | rechargeable battery powered |
| wall-mounted | color of suspension cable | fixture with natural vivid LED (upon request) |
| omni-directional light distribution | length of suspension cable | color rendering index |
| direct light distribution | reflector degree selection | color temperature |
| direct/indirect light distribution | super spot | lumen (luminous flux) |
| indirect light distribution | lens | efficacy (lumens per watt) |
| asymmetric light distribution | lens pack | Unified Glare Rating (UGR) range from 5-40 |
| aura light distribution | shine ring | marine grade (AISI 316 stainless steel) |
| round wall or ceiling cut-out | integrated shine ring with diffuser | walk on |
| square wall or ceiling cut-out | free individual colors 01-29 | drive on |
| the supplied jig specifies the cutout dimensions | individual colors: 00 (free of charge), 01-25 (extra charge) | Dark Sky Compliance |
| minimum distance (meters) lamp - object | luminaire part to be colored (F1) | Americans with Disabilities Act (less than 4" off the wall located between 27"-84" from floor) |
| recessed depth | luminaire part to be colored (F2) | lamp protected against explosion |
| ceiling thickness in mm | luminaire part to be colored (F3) | blown glass using traditional methods by master glass blower |
| ceiling thickness selection | luminaire part to be colored (F4) | acoustic material |
| dimmable DP (phase), DV (0-10V), DD (dali), DS (step-dim) | luminaire part to be colored (F5) | protection class I, protection insulation |
| included or excluded LED driver/transformer/control gear | color of 3-circuit adaptor | protection class II, protection insulation |
| separately switchable | indirect diffuser | ETL Certified to UL and CSA Standards |
| sensor | direct diffuser | UL Certified to UL and CSA Standards |
| remote control | ball-proof (upon request) | CSA Certified to UL and CSA Standards |
| available upon request | accessory | Certified for North American Standards |

IP RATING

| | |
|------|--|
| IP20 | protected against ingress of solid bodies greater than 12.5mm (finger) |
| IP33 | protected against ingress of solid bodies greater than 2.5mm protected against sprays of water up to 60 degrees from the vertical (rain) |
| IP40 | protected against ingress of solid bodies greater than 1mm (wire) no protection against the ingress of moisture |
| IP43 | protected against ingress of solid bodies greater than 1mm (wire) protected against sprays of water up to 60 degrees from the vertical (rain) |
| IP44 | protected against ingress of solid bodies greater than 1mm (wire) protected against water splashed from all directions |
| IP54 | protected against limited ingress of dust (wet rooms/covered outdoor areas) protected against water splashed from all directions |
| IP65 | protected against ingress of dust protected against jets of water |
| IP66 | protected against ingress of dust protected against powerful jets of water or heavy seas |
| IP67 | protected against ingress of dust protected against immersion of water between 15cm - 1m for 30 minutes |
| IP68 | protected against ingress of dust protected against immersion of water under pressure for long periods |

IK RATING

| | |
|------|---|
| IK01 | protected against 0.14 joules impact (equivalent to 0.25kg mass dropped from 56mm above the surface) |
| IK02 | protected against 0.2 joules impact (equivalent to 0.25kg mass dropped from 80mm above the surface) |
| IK03 | protected against 0.35 joules impact (equivalent to 0.25kg mass dropped from 140mm above the surface) |
| IK04 | protected against 0.5 joules impact (equivalent to 0.25kg mass dropped from 200mm above the surface) |
| IK05 | protected against 0.7 joules impact (equivalent to 0.25kg mass dropped from 280mm above the surface) |
| IK06 | protected against 1 joules impact (equivalent to 0.25kg mass dropped from 400mm above the surface) |
| IK07 | protected against 2 joules impact (equivalent to 0.5kg mass dropped from 400mm above the surface) |
| IK08 | protected against 5 joules impact (equivalent to 1.7kg mass dropped from 300mm above the surface) |
| IK09 | protected against 10 joules impact (equivalent to 5.0kg mass dropped from 200mm above the surface) |
| IK10 | protected against 20 joules impact (equivalent to 5.0kg mass dropped from 400mm above the surface) |