

PROJECT	
TYPE	
SPECIFIER	
QUANTITY	
DATE	

SPICA 1 PENDANT SUSPENSION

D101527-

base number Finish
Options

- To build a product code in our configurator select the specify button on the base model # product page
- To build a manual product code on this datasheet choose from the options listed below in blue font and add the suffix to the base model #

GENERAL

Series: Spica
Subseries: Spica 1 Pendant
Brand: Quasar
Division: Design
Mounting Type: Suspension
Mounting Location: Ceiling

PHYSICAL

Shape: Abstract
Diameter (mm): 200
Diameter (in): 7 7/8
Height (mm): 150
Height (in): 5 7/8
Max. Overall Height (mm): 2150
Max. Overall Height (in): 84 5/8
Light Distribution: Direct
Weight (kg): 1
Weight (lbs): 2.2
Diffuser: Acrylic Shade - See Finish Options
[Fixture Finish: RED / ORG / YEL / GRN / BLU / TRA](#)
Fixture Material: Aluminum
Cable Details: 2000mm (78 3/4") Black Cable

ELECTRICAL

Lamp Type: LED
Total Output Wattage (W): 2.2
Dimming: Phase Dimming (120Vac Only)
Driver Included: No
Driver Location: Remote
Driver Type: Constant Current - 120 / 277Vac
Driver Class: Class 2
Input Voltage (V): 120 - 277
Constant Current (MA): 250
Upon Request: (Not included - see components) Phase dimming @120Vac only / Non-dimming @277Vac

LED

Number of LEDs: 1
Color Temperature (°K): 2700
Max. Delivered Lumen (lm): 150
CRI: >90 CRI
Lamp Life (hrs): 50000

OPTICAL

RATINGS AND CERTIFICATIONS

Certified By: Certified for North American Standards
IP rating: IP20



SPICA 1 PENDANT SUSPENSION

D101527-

PROJECT

TYPE

SPECIFIER

QUANTITY

DATE



D

PROJECT
TYPE
SPECIFIER
QUANTITY
DATE

SPICA 1 PENDANT SUSPENSION

D101624-

base number Finish
Options

- To build a product code in our configurator select the specify button on the base model # product page
- To build a manual product code on this datasheet choose from the options listed below in blue font and add the suffix to the base model #

GENERAL

Series: Spica
Subseries: Spica 1 Pendant
Brand: Quasar
Division: Design
Mounting Type: Suspension
Mounting Location: Ceiling
Subcategory: Pendant

PHYSICAL

Shape: Abstract
Diameter (mm): 200
Diameter (in): 7 7/8
Height (mm): 150
Height (in): 5 7/8
Max. Overall Height (mm): 2150
Max. Overall Height (in): 84 5/8
Light Distribution: Direct
Weight (kg): 1
Weight (lbs): 2.2
Diffuser: Acrylic Shade – See Finish Options
Fixture Finish: RED / ORG / YEL / GRN / BLU / TRA
Fixture Material: Aluminum
Cable Details: 2000mm (78 3/4") Black Cable

ELECTRICAL

Lamp Type: LED
Total Output Wattage (W): 2.2
Driver Included: No
Driver Location: Remote
Driver Type: Constant Current - 120 / 277Vac
Driver Class: Class 2
Input Voltage (V): 120 - 277
Constant Current (MA): 250
Upon Request: (Not included - see components) Remote: 0-10Vdc dimming / Phase dimming @120Vac only / Non-dimming 277Vac

LED

Color Temperature (°K): 2700
Max. Delivered Lumen (lm): 150
CRI: >90 CRI
Lamp Life (hrs): 50000

OPTICAL

RATINGS AND CERTIFICATIONS

Certified By: Certified for North American Standards
IP rating: IP20

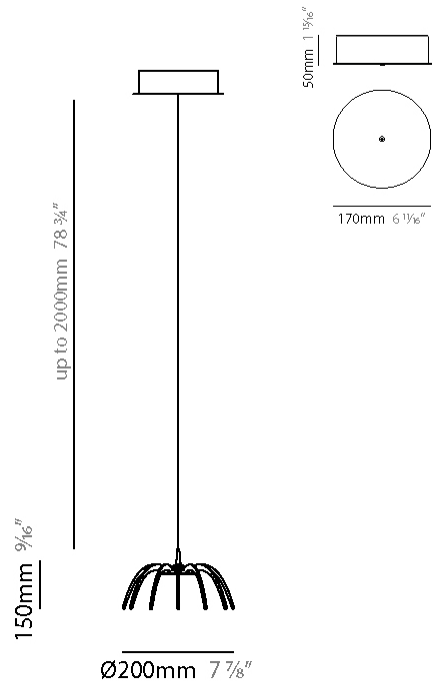

SPICA 1 PENDANT SUSPENSION

D101624-

PROJECT

TYPE

SPECIFIER

QUANTITY

DATE



SPICA 3 PENDANT SUSPENSION

D101636-

base number _____
 Finish Options _____

- To build a product code in our configurator select the specify button on the base model # product page
- To build a manual product code on this datasheet choose from the options listed below in blue font and add the suffix to the base model #

GENERAL

Series: Spica _____
 Subseries: Spica 3 Pendant _____
 Brand: Quasar _____
 Division: Design _____
 Mounting Type: Suspension _____
 Mounting Location: Ceiling _____

PHYSICAL

Shape: Abstract _____
 Diameter (mm): 300 _____
 Diameter (in): 11 ¹³/₁₆ _____
 Length (mm): 1200 _____
 Length (in): 47 ¹/₄ _____
 Height (mm): 150 _____
 Height (in): 5 ⁷/₈ _____
 Max. Overall Height (mm): 2150 _____
 Max. Overall Height (in): 84 ⁵/₈ _____
 Light Distribution: Direct _____
 Weight (kg): 5 _____
 Weight (lbs): 11.02 _____
 Diffuser: Acrylic Shade – See Finish Options _____
 Fixture Finish: RED / ORG / YEL / GRN / BLU / TRA _____
 Fixture Material: Aluminum _____
 Cable Details: 2000mm (78 3/4") Black Cable _____

ELECTRICAL

Lamp Type: LED _____
 Total Output Wattage (W): 6.6 _____
 Dimming: Phase Dimming (120Vac Only) _____
 Driver Included: Yes _____
 Driver Location: Integrated _____
 Driver Type: Constant Current - 120Vac _____
 Driver Class: Class 2 _____
 Input Voltage (V): 120 - 277 _____
 Constant Current (MA): 250 _____
 Upon Request: (Not included - see components) Integral: Phase dimming @120Vac only / Non-dimming @277Vac _____

LED

Color Temperature (°K): 2700 _____
 Max. Delivered Lumen (lm): 450 _____
 CRI: >90 CRI _____
 Lamp Life (hrs): 50000 _____

OPTICAL

RATINGS AND CERTIFICATIONS

Certified By: Certified for North American Standards _____
 IP rating: IP20 _____

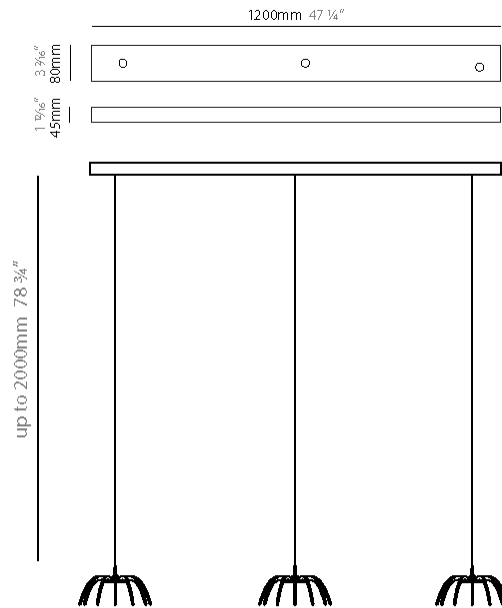

SPICA 3 PENDANT SUSPENSION

D101636-

PROJECT

TYPE

SPECIFIER

QUANTITY

DATE

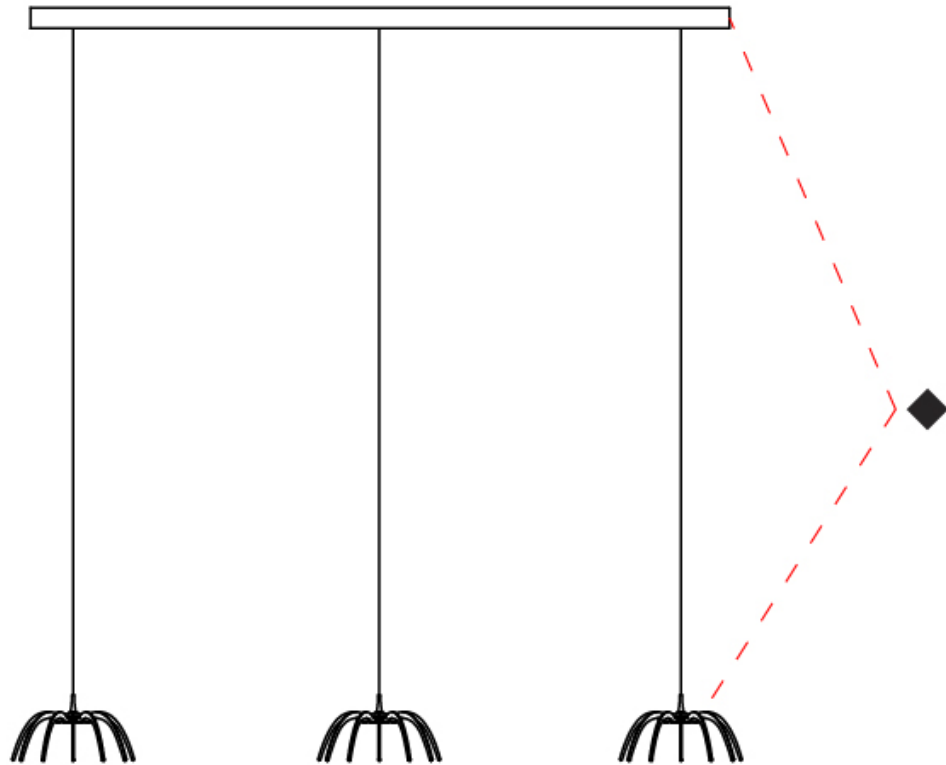

D

PROJECT	
TYPE	
SPECIFIER	
QUANTITY	
DATE	

SPICA 7 PENDANT SUSPENSION

D101695

base number

- To build a product code in our configurator select the specify button on the base model # product page
- To build a manual product code on this datasheet choose from the options listed below in blue font and add the suffix to the base model #

GENERAL

Series: Spica
 Subseries: Spica 7 Pendant
 Brand: Quasar
 Division: Design
 Mounting Type: Suspension
 Mounting Location: Ceiling

PHYSICAL

Shape: Abstract
 Diameter (mm): 600
 Diameter (in): 23 5/8
 Height (mm): 150
 Height (in): 5 7/8
 Max. Overall Height (mm): 2150
 Max. Overall Height (in): 84 5/8
 Light Distribution: Direct
 Diffuser: Acrylic Shade – See Finish Options
 Fixture Finish: RED / ORG / YEL / GRN / BLU / TRA
 Fixture Material: Aluminum
 Cable Details: 2000mm (78 3/4") Black Cable

ELECTRICAL

Lamp Type: LED
 Total Output Wattage (W): 15.4
 Max. Wattage Per Lamp (W): 2.2
 Dimming: Phase Dimming (120Vac Only)
 Driver Included: Yes
 Driver Location: Integrated
 Driver Type: Constant Current - 120Vac
 Driver Class: Class 2
 Input Voltage (V): 120 - 277
 Constant Current (MA): 250
 Upon Request: (Not included - see components) Integral: Phase dimming @120Vac only / Non-dimming @277Vac

LED

Number of LEDs: 7
 Color Temperature (°K): 2700
 Max. Delivered Lumen (lm): 1050
 CRI: >90 CRI
 Lamp Life (hrs): 50000

OPTICAL

RATINGS AND CERTIFICATIONS

Certified By: Certified for North American Standards
 IP rating: IP20

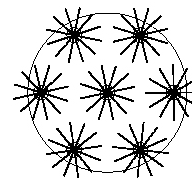
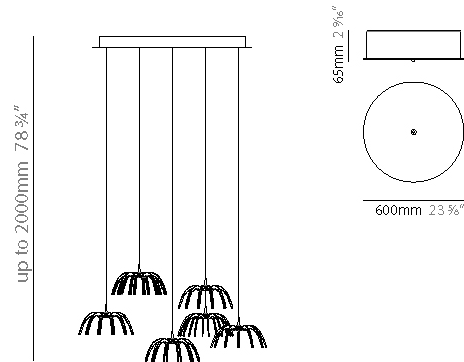

Ø600mm 23 5/8"



SPICA 7 PENDANT SUSPENSION

D101695

PROJECT

TYPE

SPECIFIER

QUANTITY

DATE

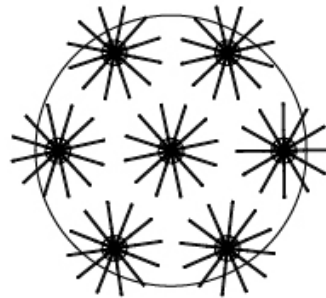
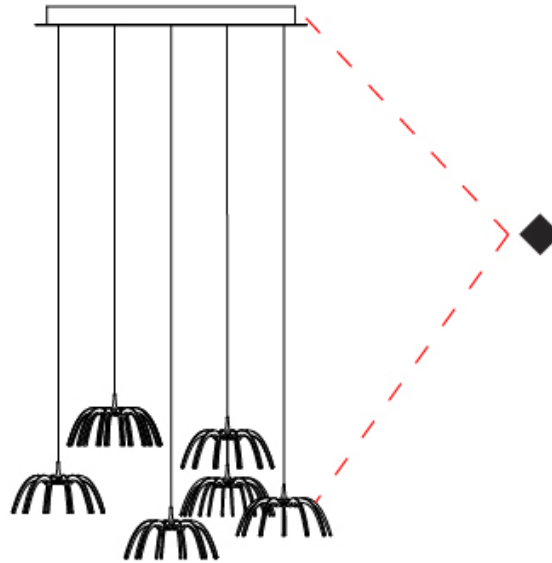

D

SPICA COLOR FINISH CHART

PROJECT	_____
TYPE	_____
SPECIFIER	_____
QUANTITY	_____
DATE	_____

Fixture Finish

Red - RED



Orange - ORG



Yellow - YEL



Green - GRN



Blue - BLU



Transparent - TRA



Digital: Not all screens are calibrated the same, and therefore, colors will appear differently between screens.

Physical: When texture is involved, there will be variations in color, character and tone within a product series and between product families.



PROJECT	
TYPE	
SPECIFIER	
QUANTITY	
DATE	

LEGEND

floor-mounted	pivotal	special LED (upon request) RGB, RGBW, tunable, gold+, meat+, art+, fashion+
wall and ceiling: recessed and surface mounted	rotating	warm dim / natural dimming LED
ceiling-mounted and wall-mounted	illuminate tilted	rechargeable battery powered
wall-mounted	color of suspension cable	fixture with natural vivid LED (upon request)
omni-directional light distribution	length of suspension cable	color rendering index
direct light distribution	reflector degree selection	color temperature
direct/indirect light distribution	super spot	lumen (luminous flux)
indirect light distribution	lens	efficacy (lumens per watt)
asymmetric light distribution	lens pack	Unified Glare Rating (UGR) range from 5-40
aura light distribution	shine ring	marine grade (AISI 316 stainless steel)
round wall or ceiling cut-out	integrated shine ring with diffuser	walk on
square wall or ceiling cut-out	free individual colors 01-29	drive on
the supplied jig specifies the cutout dimensions	individual colors: 00 (free of charge), 01-25 (extra charge)	Dark Sky Compliance
minimum distance (meters) lamp - object	luminaire part to be colored (F1)	Americans with Disabilities Act (less than 4" off the wall located between 27"-84" from floor)
recessed depth	luminaire part to be colored (F2)	lamp protected against explosion
ceiling thickness in mm	luminaire part to be colored (F3)	blown glass using traditional methods by master glass blower
ceiling thickness selection	luminaire part to be colored (F4)	acoustic material
dimmable DP (phase), DV (0-10V), DD (dali), DS (step-dim)	luminaire part to be colored (F5)	protection class I, protection insulation
included or excluded LED driver/transformer/control gear	color of 3-circuit adaptor	protection class II, protection insulation
separately switchable	indirect diffuser	ETL Certified to UL and CSA Standards
sensor	direct diffuser	UL Certified to UL and CSA Standards
remote control	ball-proof (upon request)	CSA Certified to UL and CSA Standards
available upon request	accessory	Certified for North American Standards

IP RATING

IP20	protected against ingress of solid bodies greater than 12.5mm (finger)
IP33	protected against ingress of solid bodies greater than 2.5mm protected against sprays of water up to 60 degrees from the vertical (rain)
IP40	protected against ingress of solid bodies greater than 1mm (wire) no protection against the ingress of moisture
IP43	protected against ingress of solid bodies greater than 1mm (wire) protected against sprays of water up to 60 degrees from the vertical (rain)
IP44	protected against ingress of solid bodies greater than 1mm (wire) protected against water splashed from all directions
IP54	protected against limited ingress of dust (wet rooms/covered outdoor areas) protected against water splashed from all directions
IP65	protected against ingress of dust protected against jets of water
IP66	protected against ingress of dust protected against powerful jets of water or heavy seas
IP67	protected against ingress of dust protected against immersion of water between 15cm - 1m for 30 minutes
IP68	protected against ingress of dust protected against immersion of water under pressure for long periods

IK RATING

IK01	protected against 0.14 joules impact (equivalent to 0.25kg mass dropped from 56mm above the surface)
IK02	protected against 0.2 joules impact (equivalent to 0.25kg mass dropped from 80mm above the surface)
IK03	protected against 0.35 joules impact (equivalent to 0.25kg mass dropped from 140mm above the surface)
IK04	protected against 0.5 joules impact (equivalent to 0.25kg mass dropped from 200mm above the surface)
IK05	protected against 0.7 joules impact (equivalent to 0.25kg mass dropped from 280mm above the surface)
IK06	protected against 1 joules impact (equivalent to 0.25kg mass dropped from 400mm above the surface)
IK07	protected against 2 joules impact (equivalent to 0.5kg mass dropped from 400mm above the surface)
IK08	protected against 5 joules impact (equivalent to 1.7kg mass dropped from 300mm above the surface)
IK09	protected against 10 joules impact (equivalent to 5.0kg mass dropped from 200mm above the surface)
IK10	protected against 20 joules impact (equivalent to 5.0kg mass dropped from 400mm above the surface)