

PROJECT _____
 TYPE _____
 SPECIFIER _____
 QUANTITY _____
 DATE _____

STENDIMI SUSPENSION

D131040- _____
 base number

- To build a product code in our configurator select the specify button on the base model # product page
- To build a manual product code on this datasheet choose from the options listed below in blue font and add the suffix to the base model #

GENERAL

Series: Stendimi _____
 Brand: Knikerboker _____
 Division: Design _____
 Mounting Type: Suspension _____
 Mounting Location: Ceiling _____
 Subcategory: Pendant _____

PHYSICAL

Shape: Abstract _____
 Length (mm): 200 _____
 Length (in): 7 ⁷/₈ _____
 Height (mm): 230 _____
 Height (in): 9 ¹/₁₆ _____
 Max. Overall Height (mm): 2230 _____
 Max. Overall Height (in): 87 ¹³/₁₆ _____
 Light Distribution: Direct / Indirect _____
 Fixture Finish: EWH / EBK / MAN / COF / PRD / SLF / GLF / CLF / BRL / EWS / EWG / EWC / EWR / EBS / EBG / EBC / EBC / EBB / MAS / MAD / MAC / MAB / COS / CGO / CCL / CBL / PRS / PRG / PRC / PRB _____
 Fixture Material: Metal _____
 Cable Details: Silicon Cable 2000mm / 78 3/4" _____

ELECTRICAL

Lamp Type: LED _____
 Total Output Wattage (W): 9.8 _____
 Dimming: Non-Dimmable _____
 Driver Included: No _____
 Driver Location: External _____
 Driver Type: LED driver (Not Included) _____
 Driver Class: Class 2 _____
 Housing: ENCP4 _____
 Input Voltage (V): 120 _____

LED

Color Temperature (°K): 3000 _____
 Max. Delivered Lumen (lm): 1080 _____
 CRI: >80 CRI _____

OPTICAL

RATINGS AND CERTIFICATIONS

Certified By: Certified for North American Standards _____
 IP rating: IP20 _____

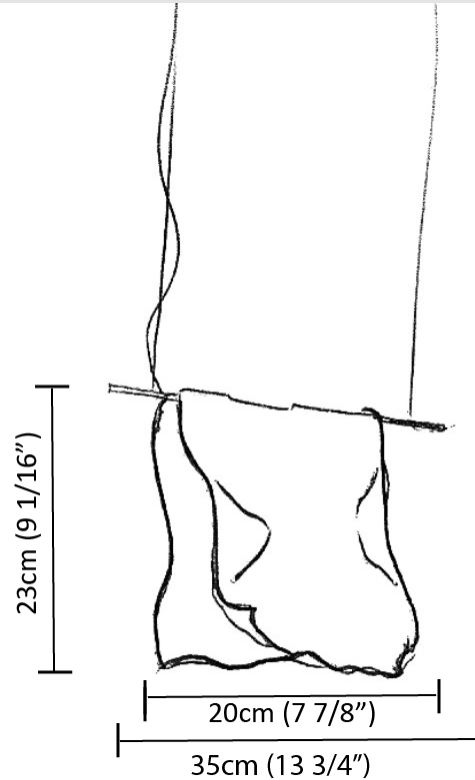

STENDIMI SUSPENSION

D131044- _____
base number

| | |
|-----------|-------|
| PROJECT | _____ |
| TYPE | _____ |
| SPECIFIER | _____ |
| QUANTITY | _____ |
| DATE | _____ |

- To build a product code in our configurator select the specify button on the base model # product page
- To build a manual product code on this datasheet choose from the options listed below in blue font and add the suffix to the base model #

GENERAL

Series: Stendimi
 Brand: Knikerboker
 Division: Design
 Mounting Type: Suspension
 Mounting Location: Ceiling
 Subcategory: Pendant

PHYSICAL

Shape: Abstract
 Length (mm): 400
 Length (in): 15 3/4
 Height (mm): 450
 Height (in): 17 11/16
 Max. Overall Height (mm): 2450
 Max. Overall Height (in): 96 7/16
 Light Distribution: Direct / Indirect
 Fixture Finish: EWH / EBK / MAN / COF / PRD / SLF / GLF / CLF / BRL / EWS / EWG / EWC / EWR / EBS / EBG / EBC / EBC / EBB / MAS / MAD / MAC / MAB / COS / CGO / CCL / CBL / PRS / PRG / PRC / PRB
 Fixture Material: Metal
 Cable Details: Silicon Cable 2000mm / 78 3/4"

ELECTRICAL

Lamp Type: LED
 Total Output Wattage (W): 14.7
 Dimming: 0-10V Dimming
 Driver Included: Yes
 Driver Location: Integrated
 Driver Type: Constant Voltage - Universal
 Driver Class: Class 2
 Input Voltage (V): 120 - 277
 Output Voltage (V): 24
 Upon Request: (Not included - see components) Remote: 0-10Vdc dimming / (Included) Integral Non-dimming 277Vac

LED

Number of LEDs: 4 strips
 Color Temperature (°K): 3000
 Max. Delivered Lumen (lm): 1620
 CRI: >80 CRI
 Lamp Life (hrs): 50000

OPTICAL

RATINGS AND CERTIFICATIONS

Certified By: Certified for North American Standards
 IP rating: IP20

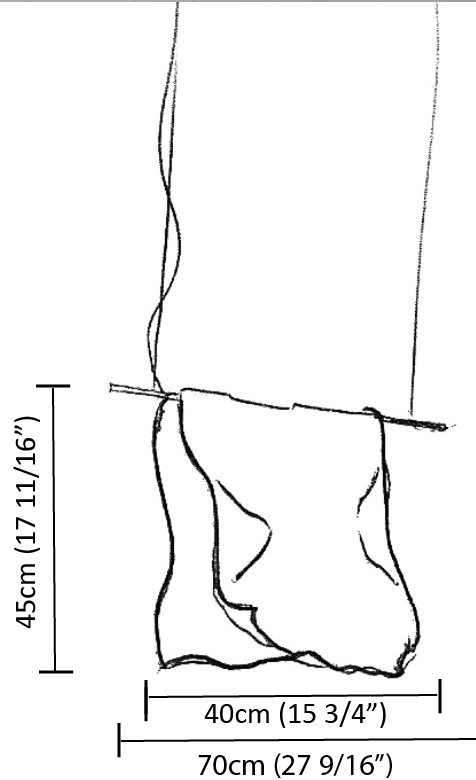

STENDIMI SUSPENSION

D131048- _____
base number

| | |
|-----------|-------|
| PROJECT | _____ |
| TYPE | _____ |
| SPECIFIER | _____ |
| QUANTITY | _____ |
| DATE | _____ |

- To build a product code in our configurator select the specify button on the base model # product page
- To build a manual product code on this datasheet choose from the options listed below in blue font and add the suffix to the base model #

GENERAL

Series: Stendimi
 Brand: Knikerboker
 Division: Design
 Mounting Type: Suspension
 Mounting Location: Ceiling
 Subcategory: Pendant

PHYSICAL

Shape: Abstract
 Length (mm): 800
 Length (in): 31 ½
 Height (mm): 950
 Height (in): 37 ¾
 Max. Overall Height (mm): 2950
 Max. Overall Height (in): 116 ⅝
 Light Distribution: Direct / Indirect
 Fixture Finish: EWH / EBK / MAN / COF / PRD / SLF / GLF / CLF / BRL / EWS / EWG / EWC / EWR / EBS / EBG / EBC / EBC / EBB / MAS / MAD / MAC / MAB / COS / CGO / CCL / CBL / PRS / PRG / PRC / PRB
 Fixture Material: Metal
 Cable Details: 2 Steel Cables 2000mm

ELECTRICAL

Lamp Type: LED
 Total Output Wattage (W): 29.4
 Dimming: 0-10V Dimming
 Driver Included: Yes
 Driver Location: Integrated
 Driver Type: Constant Voltage - Universal
 Driver Class: Class 2
 Input Voltage (V): 120 - 277
 Output Voltage (V): 24
 Upon Request: (Not included - see components) Remote: 0-10Vdc dimming / (Included) Integral Non-dimming 277Vac

LED

Number of LEDs: 8 strips
 Color Temperature (°K): 3000
 Max. Delivered Lumen (lm): 3240
 CRI: >80 CRI
 Lamp Life (hrs): 50000

OPTICAL

RATINGS AND CERTIFICATIONS

Certified By: Certified for North American Standards
 IP rating: IP20

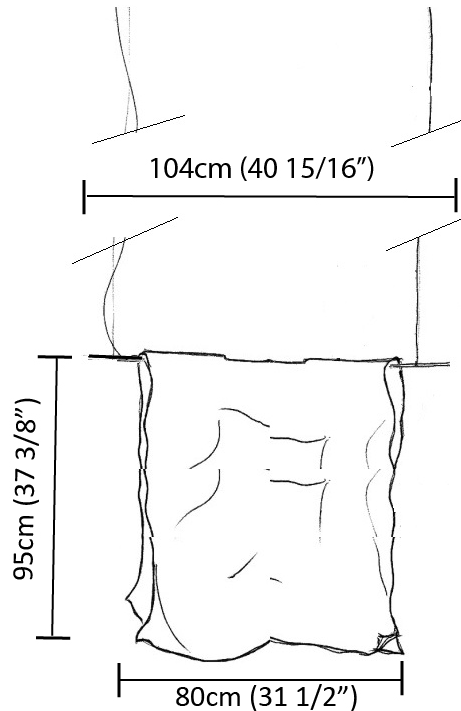

D

STENDIMI SUSPENSION

D131061- _____
base number

| | |
|-----------|-------|
| PROJECT | _____ |
| TYPE | _____ |
| SPECIFIER | _____ |
| QUANTITY | _____ |
| DATE | _____ |

- To build a product code in our configurator select the specify button on the base model # product page
- To build a manual product code on this datasheet choose from the options listed below in blue font and add the suffix to the base model #

GENERAL

Series: Stendimi
 Brand: Knikerboker
 Division: Design
 Mounting Type: Suspension
 Mounting Location: Ceiling
 Subcategory: Pendant

PHYSICAL

Shape: Abstract
 Length (mm): 1000
 Length (in): 39 3/8
 Height (mm): 750
 Height (in): 29 1/2
 Max. Overall Height (mm): 2750
 Max. Overall Height (in): 108 1/4
 Light Distribution: Direct / Indirect
 Fixture Finish: EWH / EBK / MAN / COF / PRD / SLF / GLF / CLF / BRL / EWS / EWG / EWC / EWR / EBS / EBG / EBC / EBC / EBB / MAS / MAD / MAC / MAB / COS / CGO / CCL / CBL / PRS / PRG / PRC / PRB
 Fixture Material: Metal
 Cable Details: Silicon Cable 2000mm / 78 3/4"

ELECTRICAL

Lamp Type: LED
 Total Output Wattage (W): 29.4
 Dimming: 0-10V Dimming
 Driver Included: Yes
 Driver Location: Integrated
 Driver Type: Constant Voltage - Universal
 Driver Class: Class 2
 Input Voltage (V): 120 - 277
 Output Voltage (V): 24
 Upon Request: (Not included - see components) Remote: 0-10Vdc dimming / (Included) Integral Non-dimming 277Vac

LED

Number of LEDs: 8 strips
 Color Temperature (°K): 3000
 Max. Delivered Lumen (lm): 3240
 CRI: >80 CRI
 Lamp Life (hrs): 50000

OPTICAL

RATINGS AND CERTIFICATIONS

Certified By: Certified for North American Standards
 IP rating: IP20

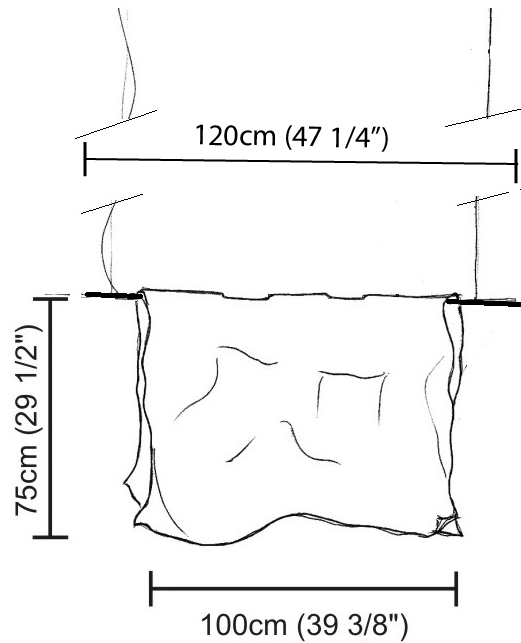

STENDIMI COLOR FINISH CHART

| |
|-----------|
| PROJECT |
| TYPE |
| SPECIFIER |
| QUANTITY |
| DATE |

Fixture Finish

Embossed White - EWH



Embossed Black - EBK



Metallic Anthracite - MAN



Coffee - COF

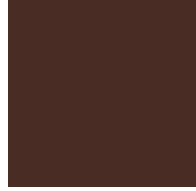

Purple Red - PRD



Silver Leaf - SLF

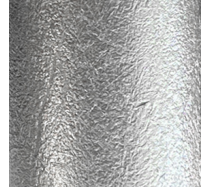

Gold Leaf - GLF



Copper Leaf - CLF

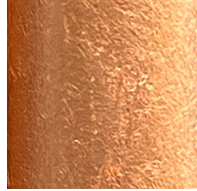

Bronze Leaf - BRL



Metallic Anthracite / Silver Leaf - MAS

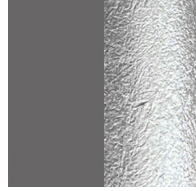

Metallic Anthracite / Gold Leaf - MAD



Metallic Anthracite / Copper Leaf - MAC

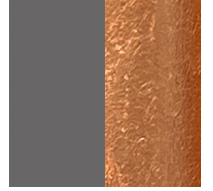

Metallic Anthracite / Bronze Leaf - MAB

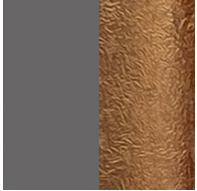

Coffee / Silver Leaf - COS

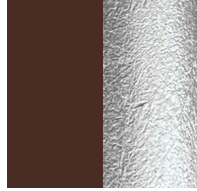

Coffee / Gold Leaf - CGO

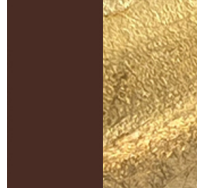

Coffee / Copper Leaf - CCL



Coffee / Bronze Leaf - CBL



Purple Red / Silver Leaf - PRS

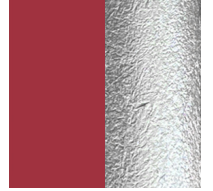

Purple Red / Gold Leaf - PRG

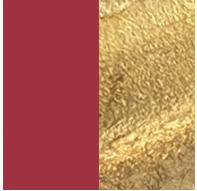

Purple Red / Copper Leaf - PRC

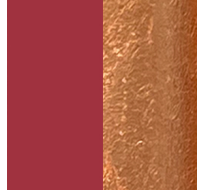

Purple Red / Bronze Leaf - PRB



Digital: Not all screens are calibrated the same, and therefore, colors will appear differently between screens.

Physical: When texture is involved, there will be variations in color, character and tone within a product series and between product families.



LEGEND

| | | | | | |
|--|---|---|--|---|--|
|  | floor-mounted |  | pivotal |  | special LED (upon request) RGB, RGBW, tunable, gold+, meat+, art+, fashion+ |
|  | wall and ceiling: recessed and surface mounted |  | rotating |  | warm dim / natural dimming LED |
|  | ceiling-mounted and wall-mounted |  | illuminate tilted |  | rechargeable battery powered |
|  | wall-mounted |  | color of suspension cable |  | fixture with natural vivid LED (upon request) |
|  | omni-directional light distribution |  | length of suspension cable |  | color rendering index |
|  | direct light distribution |  | reflector degree selection |  | color temperature |
|  | direct/indirect light distribution |  | super spot |  | lumen (luminous flux) |
|  | indirect light distribution |  | lens |  | efficacy (lumens per watt) |
|  | asymmetric light distribution |  | lens pack |  | Unified Glare Rating (UGR) range from 5-40 |
|  | aura light distribution |  | shine ring |  | marine grade (AISI 316 stainless steel) |
|  | round wall or ceiling cut-out |  | integrated shine ring with diffuser |  | walk on |
|  | square wall or ceiling cut-out |  | free individual colors 01-29 |  | drive on |
|  | the supplied jig specifies the cutout dimensions |  | individual colors: 00 (free of charge), 01-25 (extra charge) |  | Dark Sky Compliance |
|  | minimum distance (meters) lamp - object |  | luminaire part to be colored (F1) |  | Americans with Disabilities Act (less than 4" off the wall located between 27"-84" from floor) |
|  | recessed depth |  | luminaire part to be colored (F2) |  | lamp protected against explosion |
|  | ceiling thickness in mm |  | luminaire part to be colored (F3) |  | blown glass using traditional methods by master glass blower |
|  | ceiling thickness selection |  | luminaire part to be colored (F4) |  | acoustic material |
|  | dimmable DP (phase), DV (0-10V), DD (dali), DS (step-dim) |  | luminaire part to be colored (F5) |  | protection class I, protection insulation |
|  | included or excluded LED driver/transformer/control gear |  | color of 3-circuit adaptor |  | protection class II, protection insulation |
|  | separately switchable |  | indirect diffuser |  | ETL Certified to UL and CSA Standards |
|  | sensor |  | direct diffuser |  | UL Certified to UL and CSA Standards |
|  | remote control |  | ball-proof (upon request) |  | CSA Certified to UL and CSA Standards |
|  | available upon request |  | accessory |  | Certified for North American Standards |

IP RATING

| | |
|---|--|
|  | protected against ingress of solid bodies greater than 12.5mm (finger) |
|  | protected against ingress of solid bodies greater than 2.5mm protected against sprays of water up to 60 degrees from the vertical (rain) |
|  | protected against ingress of solid bodies greater than 1mm (wire) no protection against the ingress of moisture |
|  | protected against ingress of solid bodies greater than 1mm (wire) protected against sprays of water up to 60 degrees from the vertical (rain) |
|  | protected against ingress of solid bodies greater than 1mm (wire) protected against water splashed from all directions |
|  | protected against limited ingress of dust (wet rooms/covered outdoor areas) protected against water splashed from all directions |
|  | protected against ingress of dust protected against jets of water |
|  | protected against ingress of dust protected against powerful jets of water or heavy seas |
|  | protected against ingress of dust protected against immersion of water between 15cm - 1m for 30 minutes |
|  | protected against ingress of dust protected against immersion of water under pressure for long periods |

IK RATING

| | |
|---|---|
|  | protected against 0.14 joules impact (equivalent to 0.25kg mass dropped from 56mm above the surface) |
|  | protected against 0.2 joules impact (equivalent to 0.25kg mass dropped from 80mm above the surface) |
|  | protected against 0.35 joules impact (equivalent to 0.25kg mass dropped from 140mm above the surface) |
|  | protected against 0.5 joules impact (equivalent to 0.25kg mass dropped from 200mm above the surface) |
|  | protected against 0.7 joules impact (equivalent to 0.25kg mass dropped from 280mm above the surface) |
|  | protected against 1 joules impact (equivalent to 0.25kg mass dropped from 400mm above the surface) |
|  | protected against 2 joules impact (equivalent to 0.5kg mass dropped from 400mm above the surface) |
|  | protected against 5 joules impact (equivalent to 1.7kg mass dropped from 300mm above the surface) |
|  | protected against 10 joules impact (equivalent to 5.0kg mass dropped from 200mm above the surface) |
|  | protected against 20 joules impact (equivalent to 5.0kg mass dropped from 400mm above the surface) |