

|           |
|-----------|
| PROJECT   |
| TYPE      |
| SPECIFIER |
| QUANTITY  |
| DATE      |

## TAO MONOPOINT SUSPENSION

### D141111-

base number                      Finish  
Options

- To build a product code in our configurator select the specify button on the base model # product page
- To build a manual product code on this datasheet choose from the options listed below in blue font and add the suffix to the base model #

#### GENERAL

Series: Tao  
 Subseries: Tao Monopoint  
 Brand: Cangini & Tucci  
 Division: Design  
 Mounting Type: Suspension  
 Mounting Location: Ceiling  
 Subcategory: Pendant

#### PHYSICAL

Shape: Cylinder  
 Diameter (mm): 80  
 Diameter (in): 3 1/8  
 Height (mm): 300  
 Height (in): 11 13/16  
 Max. Overall Height (mm): 1800  
 Max. Overall Height (in): 70 7/8  
 Light Distribution: Omnidirectional  
 Weight (kg): 0.80  
 Weight (lbs): 1.76  
 Fixture Finish: [AMB](#) / [GRN](#) / [PNK](#) / [RUB](#) / [SMK](#) / [TOB](#) / [TRA](#) / [RGD](#) / [TIM](#)  
 Holder Finish: CHR  
 Fixture Material: Glass / Metal  
 Cable Details: 1500mm Cable

#### ELECTRICAL

Number of Lamps: 1  
 Lamp Type: LED Retrofit  
 Bulb Included: Bulb Not Included  
 Max. Wattage Per Lamp (W): 3  
 Lamp Base: G9  
 Input Voltage (V): 120  
 Upon Request: GU24 / 277Vac

#### LED

#### OPTICAL

#### RATINGS AND CERTIFICATIONS

Certified By: Certified for North American Standards  
 IP rating: IP20

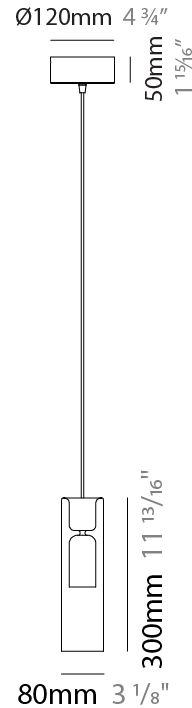

## TAO MONOPOINT SUSPENSION

D141111-

PROJECT

TYPE

SPECIFIER

QUANTITY

DATE

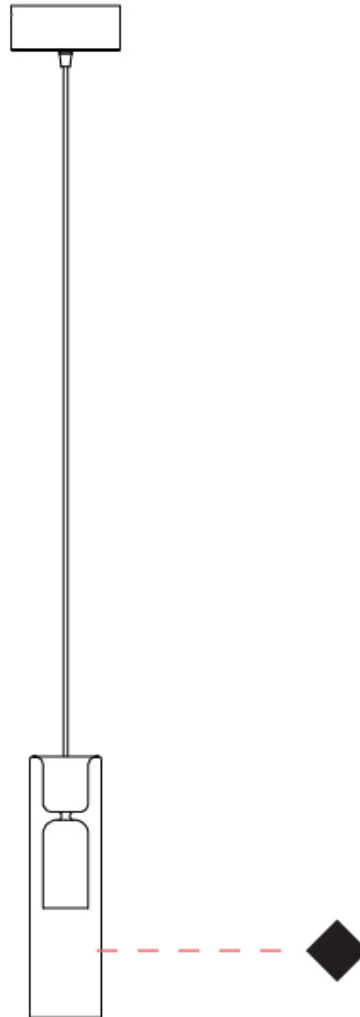

D

|           |  |
|-----------|--|
| PROJECT   |  |
| TYPE      |  |
| SPECIFIER |  |
| QUANTITY  |  |
| DATE      |  |

## TAO MONOPOINT SUSPENSION

### D141112-

base number            Finish             
Options           

- To build a product code in our configurator select the specify button on the base model # product page
- To build a manual product code on this datasheet choose from the options listed below in blue font and add the suffix to the base model #

#### GENERAL

Series: Tao             
 Subseries: Tao Monopoint             
 Brand: Cangini & Tucci             
 Division: Design             
 Mounting Type: Suspension             
 Mounting Location: Ceiling             
 Subcategory: Pendant           

#### PHYSICAL

Shape: Cylinder             
 Diameter (mm): 100             
 Diameter (in): 3 <sup>15</sup>/<sub>16</sub>             
 Height (mm): 370             
 Height (in): 14 <sup>9</sup>/<sub>16</sub>             
 Max. Overall Height (mm): 1870             
 Max. Overall Height (in): 73 <sup>5</sup>/<sub>8</sub>             
 Light Distribution: Omnidirectional             
 Weight (kg): 1.5             
 Weight (lbs): 3.31             
 Fixture Finish: AMB / GRN / PNK / RUB / SMK / TOB / TRA / RGD / TIM             
 Holder Finish: CHR             
 Fixture Material: Glass / Metal             
 Cable Details: 1500mm Cable           

#### ELECTRICAL

Number of Lamps: 1             
 Lamp Type: LED Retrofit             
 Bulb Included: Bulb Not Included             
 Max. Wattage Per Lamp (W): 8             
 Lamp Base: E26             
 Input Voltage (V): 120             
 Upon Request: GU24 / 277Vac           

#### LED

#### OPTICAL

#### RATINGS AND CERTIFICATIONS

Certified By: Certified for North American Standards             
 IP rating: IP20           

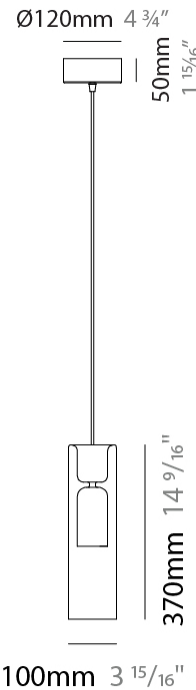

## TAO MONOPOINT SUSPENSION

D141112-

PROJECT

TYPE

SPECIFIER

QUANTITY

DATE

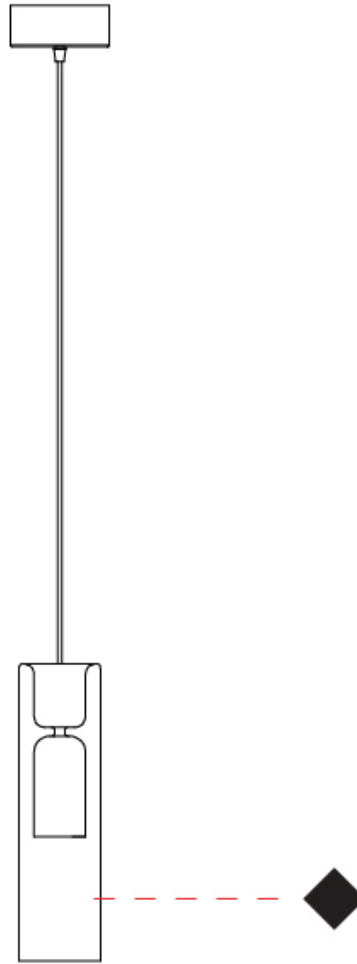

D

## TAO 2 LIGHT SWAG SUSPENSION

### D141115-

base number \_\_\_\_\_  
 Finish \_\_\_\_\_  
 Options \_\_\_\_\_

- To build a product code in our configurator select the specify button on the base model # product page
- To build a manual product code on this datasheet choose from the options listed below in blue font and add the suffix to the base model #

#### GENERAL

Series: Tao \_\_\_\_\_  
 Subseries: Tao 2 Light Swag \_\_\_\_\_  
 Brand: Cangini & Tucci \_\_\_\_\_  
 Division: Design \_\_\_\_\_  
 Mounting Type: Suspension \_\_\_\_\_  
 Mounting Location: Ceiling \_\_\_\_\_  
 Subcategory: Pendant \_\_\_\_\_

#### PHYSICAL

Shape: Cylinder \_\_\_\_\_  
 Diameter (mm): 80 \_\_\_\_\_  
 Diameter (in): 3 1/8 \_\_\_\_\_  
 Height (mm): 300 \_\_\_\_\_  
 Height (in): 11 13/16 \_\_\_\_\_  
 Max. Overall Height (mm): 2300 \_\_\_\_\_  
 Max. Overall Height (in): 90 9/16 \_\_\_\_\_  
 Light Distribution: Omnidirectional \_\_\_\_\_  
 Weight (kg): 1.5 \_\_\_\_\_  
 Weight (lbs): 3.31 \_\_\_\_\_  
 Fixture Finish: [AMB](#) / [GRN](#) / [PNK](#) / [RUB](#) / [SMK](#) / [TOB](#) / [TRA](#) / [RGD](#) / [TIM](#) \_\_\_\_\_  
 Holder Finish: CHR \_\_\_\_\_  
 Fixture Material: Glass / Metal \_\_\_\_\_  
 Cable Details: 2000mm Cable \_\_\_\_\_

#### ELECTRICAL

Number of Lamps: 2 \_\_\_\_\_  
 Lamp Type: LED Retrofit \_\_\_\_\_  
 Bulb Included: Bulb Not Included \_\_\_\_\_  
 Total Output Wattage (W): 6 \_\_\_\_\_  
 Max. Wattage Per Lamp (W): 3 \_\_\_\_\_  
 Lamp Base: G9 \_\_\_\_\_  
 Input Voltage (V): 120 \_\_\_\_\_

#### LED

#### OPTICAL

#### RATINGS AND CERTIFICATIONS

Certified By: Certified for North American Standards \_\_\_\_\_  
 IP rating: IP20 \_\_\_\_\_

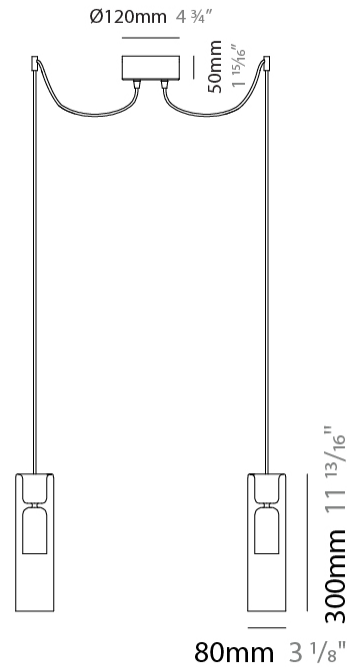

## TAO 2 LIGHT SWAG SUSPENSION

D141115-

PROJECT \_\_\_\_\_

TYPE \_\_\_\_\_

SPECIFIER \_\_\_\_\_

QUANTITY \_\_\_\_\_

DATE \_\_\_\_\_

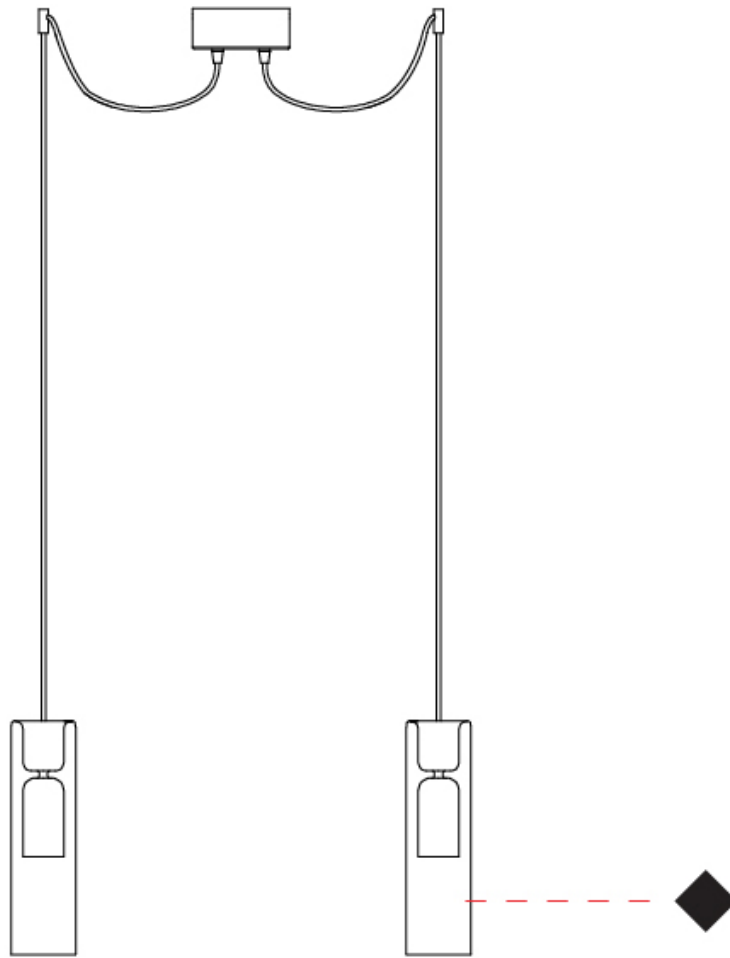

D

|           |       |
|-----------|-------|
| PROJECT   | _____ |
| TYPE      | _____ |
| SPECIFIER | _____ |
| QUANTITY  | _____ |
| DATE      | _____ |

## TAO 2 LIGHT SWAG SUSPENSION

### D141116-

base number Finish  
Options

- To build a product code in our configurator select the specify button on the base model # product page
- To build a manual product code on this datasheet choose from the options listed below in blue font and add the suffix to the base model #

#### GENERAL

Series: Tao  
 Subseries: Tao 2 Light Swag  
 Brand: Cangini & Tucci  
 Division: Design  
 Mounting Type: Suspension  
 Mounting Location: Ceiling  
 Subcategory: Pendant

#### PHYSICAL

Shape: Cylinder  
 Diameter (mm): 100  
 Diameter (in): 3 <sup>15</sup>/<sub>16</sub>  
 Height (mm): 370  
 Height (in): 14 <sup>9</sup>/<sub>16</sub>  
 Max. Overall Height (mm): 1870  
 Max. Overall Height (in): 73 <sup>5</sup>/<sub>8</sub>  
 Light Distribution: Omnidirectional  
 Weight (kg): 3.2  
 Weight (lbs): 7.05  
 Fixture Finish: [AMB](#) / [GRN](#) / [PNK](#) / [RUB](#) / [SMK](#) / [TOB](#) / [TRA](#) / [RGD](#) / [TIM](#)  
 Holder Finish: CHR  
 Fixture Material: Glass / Metal  
 Cable Details: 1500mm Cable

#### ELECTRICAL

Number of Lamps: 2  
 Lamp Type: LED Retrofit  
 Bulb Included: Bulb Not Included  
 Total Output Wattage (W): 16  
 Max. Wattage Per Lamp (W): 8  
 Lamp Base: E26  
 Input Voltage (V): 120  
 Upon Request: GU24 / 277Vac

#### LED

#### OPTICAL

#### RATINGS AND CERTIFICATIONS

Certified By: Certified for North American Standards  
 IP rating: IP20

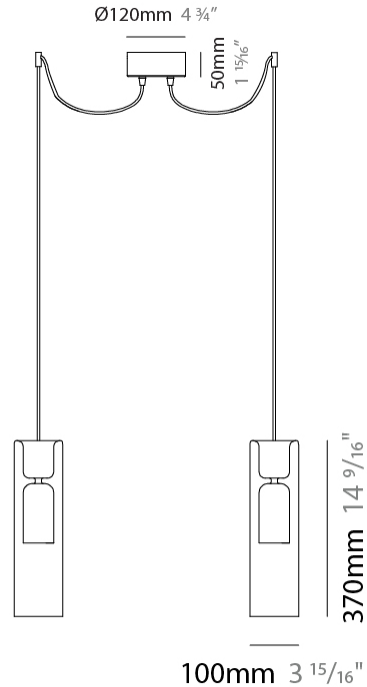

## TAO 2 LIGHT SWAG SUSPENSION

D141116-

PROJECT \_\_\_\_\_

TYPE \_\_\_\_\_

SPECIFIER \_\_\_\_\_

QUANTITY \_\_\_\_\_

DATE \_\_\_\_\_

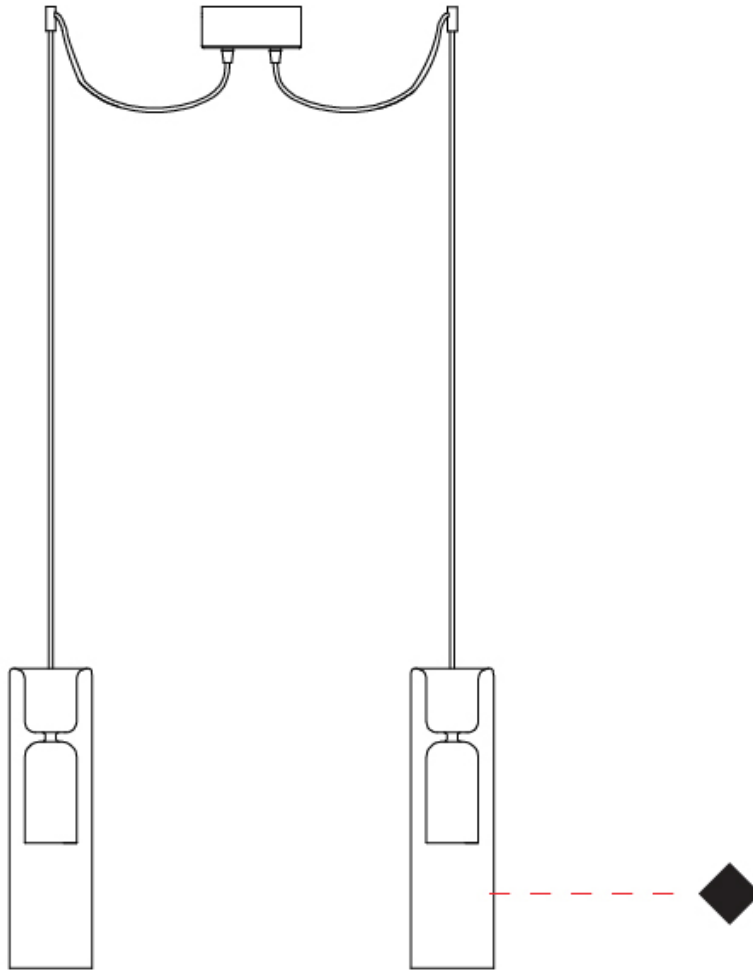

D



|           |
|-----------|
| PROJECT   |
| TYPE      |
| SPECIFIER |
| QUANTITY  |
| DATE      |

## TAO 6 LIGHT CLUSTER SUSPENSION

### D141117-

base number                      Finish                       
Options                     

- To build a product code in our configurator select the specify button on the base model # product page
- To build a manual product code on this datasheet choose from the options listed below in blue font and add the suffix to the base model #

#### GENERAL

Series: Tao                       
 Subseries: Tao 6 Light Cluster                       
 Brand: Cangini & Tucci                       
 Division: Design                       
 Mounting Type: Suspension                       
 Mounting Location: Ceiling                       
 Subcategory: Pendant                     

#### PHYSICAL

Shape: Cylinder                       
 Diameter (mm): 270                       
 Diameter (in): 10 <sup>5</sup>/<sub>8</sub>                       
 Max. Overall Height (mm): 1500                       
 Max. Overall Height (in): 59 <sup>1</sup>/<sub>16</sub>                       
 Light Distribution: Omnidirectional                       
 Weight (kg): 5.25                       
 Weight (lbs): 11.5                       
 Fixture Finish: [AMB](#) / [GRN](#) / [PNK](#) / [RUB](#) / [SMK](#) / [TOB](#) / [TRA](#) / [RGD](#) / [TIM](#)                       
 Holder Finish: PSS                       
 Fixture Material: Glass / Metal                       
 Cable Details: 1500mm Cable                     

#### ELECTRICAL

Number of Lamps: 6                       
 Lamp Type: LED Retrofit                       
 Bulb Included: Bulb Not Included                       
 Total Output Wattage (W): 18                       
 Max. Wattage Per Lamp (W): 3                       
 Lamp Base: G9                       
 Input Voltage (V): 120                     

#### LED

#### OPTICAL

#### RATINGS AND CERTIFICATIONS

Certified By: Certified for North American Standards                       
 IP rating: IP20                     



270mm 10 <sup>5</sup>/<sub>8</sub>"

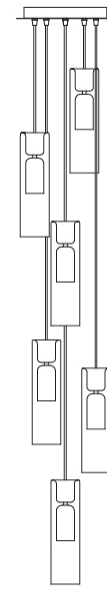

300mm 11 <sup>13</sup>/<sub>16</sub>"

Ø80mm 3 <sup>1</sup>/<sub>8</sub>"



## TAO 6 LIGHT CLUSTER SUSPENSION

D141117-

PROJECT

TYPE

SPECIFIER

QUANTITY

DATE

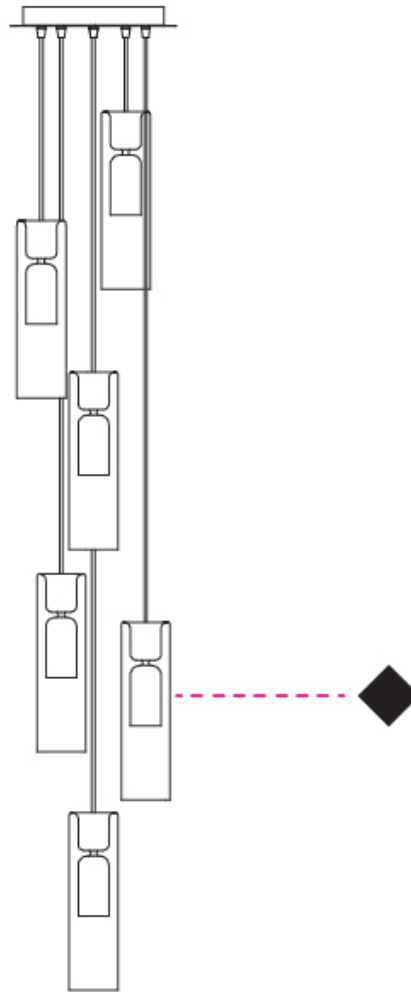

D

|           |
|-----------|
| PROJECT   |
| TYPE      |
| SPECIFIER |
| QUANTITY  |
| DATE      |

## TAO 3 LIGHT CLUSTER SUSPENSION

### D141118-

base number Finish  
Options

- To build a product code in our configurator select the specify button on the base model # product page
- To build a manual product code on this datasheet choose from the options listed below in blue font and add the suffix to the base model #

#### GENERAL

Series: Tao  
 Subseries: Tao 3 Light Cluster  
 Brand: Cangini & Tucci  
 Division: Design  
 Mounting Type: Suspension  
 Mounting Location: Ceiling  
 Subcategory: Pendant

#### PHYSICAL

Shape: Cylinder  
 Diameter (mm): 270  
 Diameter (in): 10 <sup>5</sup>/<sub>8</sub>  
 Height (mm): 1500  
 Height (in): 59 <sup>1</sup>/<sub>16</sub>  
 Light Distribution: Omnidirectional  
 Weight (kg): 5.60  
 Weight (lbs): 12.34  
 Fixture Finish: [AMB](#) / [GRN](#) / [PNK](#) / [RUB](#) / [SMK](#) / [TOB](#) / [TRA](#) / [RGD](#) / [TIM](#)  
 Holder Finish: PSS  
 Fixture Material: Glass / Metal  
 Cable Details: 1500mm Cable

#### ELECTRICAL

Number of Lamps: 3  
 Lamp Type: LED Retrofit  
 Bulb Included: Bulb Not Included  
 Total Output Wattage (W): 24  
 Max. Wattage Per Lamp (W): 8  
 Lamp Base: G9  
 Input Voltage (V): 120

#### LED

#### OPTICAL

#### RATINGS AND CERTIFICATIONS

Certified By: Certified for North American Standards  
 IP rating: IP20



270mm 10 <sup>5</sup>/<sub>8</sub>"

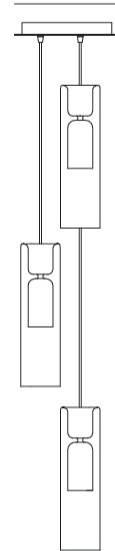

370mm 14 <sup>9</sup>/<sub>16</sub>"

Ø100mm 3 <sup>15</sup>/<sub>16</sub>"



## TAO 3 LIGHT CLUSTER SUSPENSION

D141118-

PROJECT

TYPE

SPECIFIER

QUANTITY

DATE

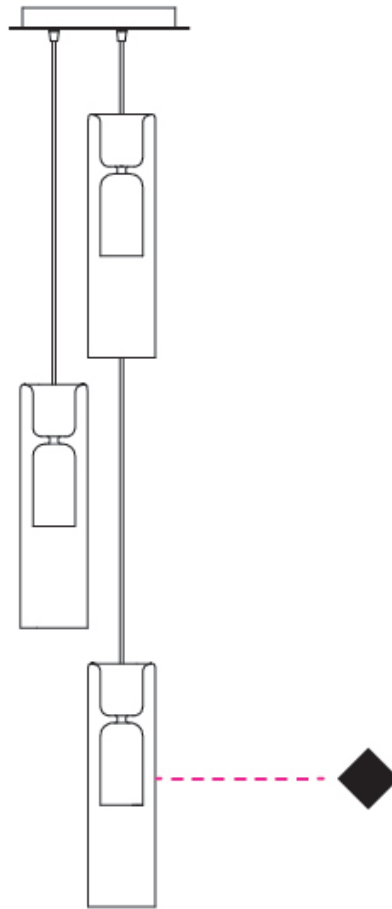

D

|           |  |
|-----------|--|
| PROJECT   |  |
| TYPE      |  |
| SPECIFIER |  |
| QUANTITY  |  |
| DATE      |  |

## TAO 3 LIGHT LINEAR SUSPENSION

### D141120-

base number Finish  
Options

- To build a product code in our configurator select the specify button on the base model # product page
- To build a manual product code on this datasheet choose from the options listed below in blue font and add the suffix to the base model #

#### GENERAL

Series: Tao  
 Subseries: Tao 3 Light Linear  
 Brand: Cangini & Tucci  
 Division: Design  
 Mounting Type: Suspension  
 Mounting Location: Ceiling  
 Subcategory: Pendant

#### PHYSICAL

Shape: Cylinder  
 Length (mm): 700  
 Length (in): 27 9/16  
 Height (mm): 1500  
 Height (in): 59 1/16  
 Light Distribution: Omnidirectional  
 Weight (kg): 6.90  
 Weight (lbs): 15.21  
 Fixture Finish: [AMB](#) / [GRN](#) / [PNK](#) / [RUB](#) / [SMK](#) / [TOB](#) / [TRA](#) / [RGD](#) / [TIM](#)  
 Holder Finish: PSS  
 Fixture Material: Glass / Metal  
 Cable Details: 1500mm Cable

#### ELECTRICAL

Number of Lamps: 3  
 Lamp Type: LED Retrofit  
 Bulb Included: Bulb Not Included  
 Total Output Wattage (W): 24  
 Max. Wattage Per Lamp (W): 8  
 Lamp Base: G9  
 Input Voltage (V): 120

#### LED

#### OPTICAL

#### RATINGS AND CERTIFICATIONS

Certified By: Certified for North American Standards  
 IP rating: IP20

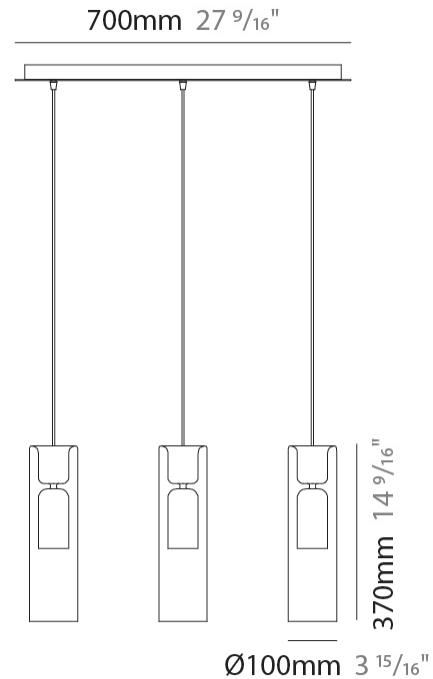

## TAO 3 LIGHT LINEAR SUSPENSION

D141120-

PROJECT \_\_\_\_\_

TYPE \_\_\_\_\_

SPECIFIER \_\_\_\_\_

QUANTITY \_\_\_\_\_

DATE \_\_\_\_\_

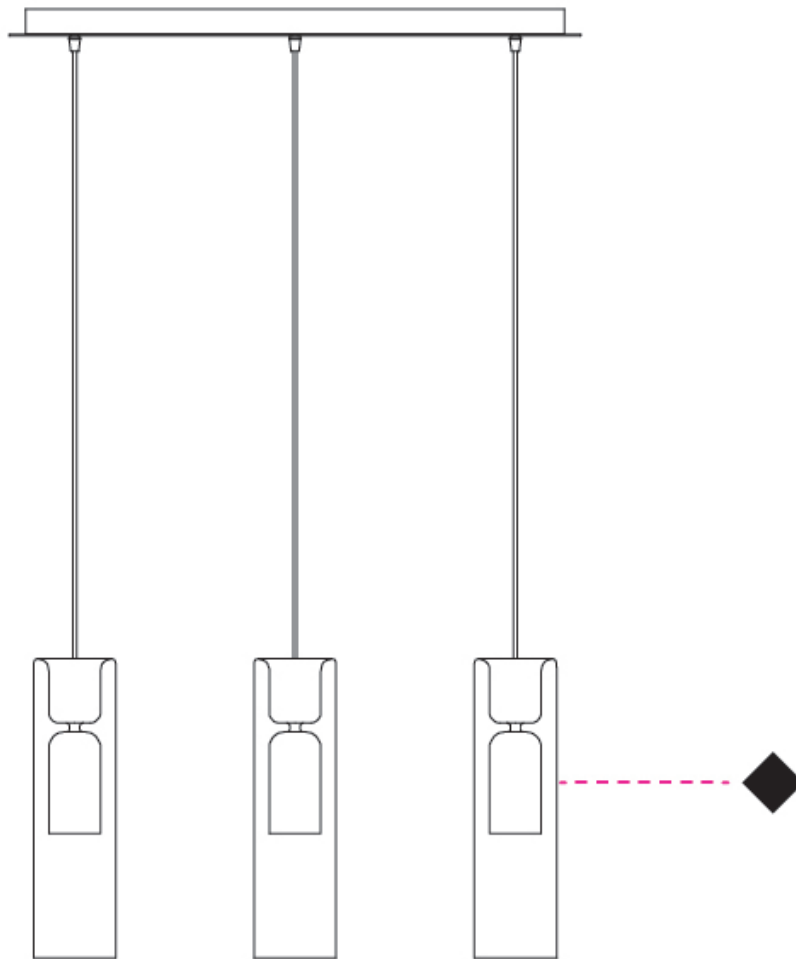

D

|           |  |
|-----------|--|
| PROJECT   |  |
| TYPE      |  |
| SPECIFIER |  |
| QUANTITY  |  |
| DATE      |  |

## TAO SURFACE

### D143018-

base number Finish  
Options

- To build a product code in our configurator select the specify button on the base model # product page
- To build a manual product code on this datasheet choose from the options listed below in blue font and add the suffix to the base model #

#### GENERAL

Series: Tao  
 Brand: Cangiini & Tucci  
 Division: Design  
 Mounting Type: Surface  
 Mounting Location: Wall  
 Subcategory: Ambient

#### PHYSICAL

Shape: Cylinder  
 Diameter (mm): 80  
 Diameter (in): 3 1/8  
 Height (mm): 330  
 Depth (mm): 160  
 Height (in): 13  
 Depth (in): 6 5/16  
 Extension (mm): 160  
 Extension (in): 6 5/16  
 Light Distribution: Omnidirectional  
 Weight (kg): 1.075  
 Weight (lbs): 2.37  
 Fixture Finish: [AMB](#) / [GRN](#) / [PNK](#) / [RUB](#) / [SMK](#) / [TOB](#) / [TRA](#) / [RGD](#) / [TIM](#)  
 Holder Finish: CHR  
 Fixture Material: Glass / Metal

#### ELECTRICAL

Number of Lamps: 1  
 Lamp Type: LED Retrofit  
 Bulb Included: Bulb Not Included  
 Max. Wattage Per Lamp (W): 3  
 Lamp Base: G9  
 Input Voltage (V): 120

#### LED

#### OPTICAL

#### RATINGS AND CERTIFICATIONS

Certified By: Certified for North American Standards  
 IP rating: IP20

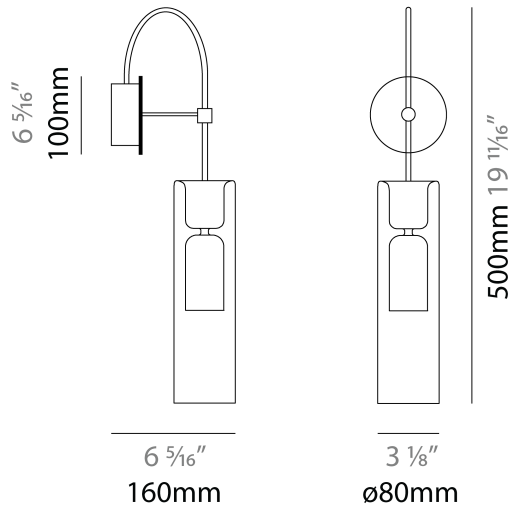

## TAO SURFACE

D143018-

|           |       |
|-----------|-------|
| PROJECT   | _____ |
| TYPE      | _____ |
| SPECIFIER | _____ |
| QUANTITY  | _____ |
| DATE      | _____ |

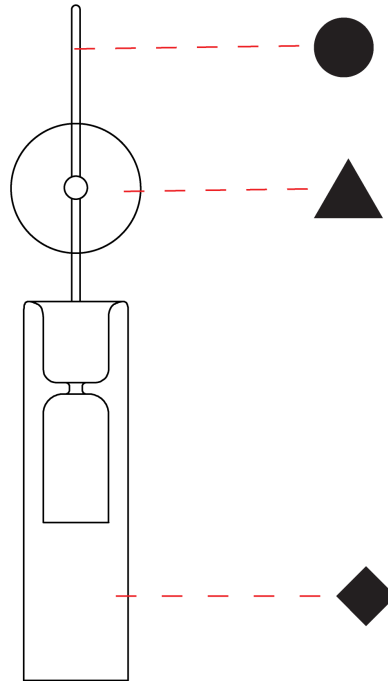

D



|           |
|-----------|
| PROJECT   |
| TYPE      |
| SPECIFIER |
| QUANTITY  |
| DATE      |

## TAO SURFACE

### D143019-

base number                      Finish                       
Options                     

- To build a product code in our configurator select the specify button on the base model # product page
- To build a manual product code on this datasheet choose from the options listed below in blue font and add the suffix to the base model #

#### GENERAL

Series: Tao                       
 Brand: Cangini & Tucci                       
 Division: Design                       
 Mounting Type: Surface                       
 Mounting Location: Wall                       
 Subcategory: Ambient                     

#### PHYSICAL

Shape: Cylinder                       
 Diameter (mm): 100                       
 Diameter (in): 3 <sup>15</sup>/<sub>16</sub>                       
 Height (mm): 370                       
 Height (in): 14 <sup>9</sup>/<sub>16</sub>                       
 Light Distribution: Omnidirectional                       
 Weight (kg): 0.90                       
 Weight (lbs): 1.98                       
 Fixture Finish: [AMB](#) / [GRN](#) / [PNK](#) / [RUB](#) / [SMK](#) / [TOB](#) / [TRA](#) / [RGD](#) / [TIM](#)                       
 Holder Finish: CHR                       
 Fixture Material: Glass / Metal                     

#### ELECTRICAL

Number of Lamps: 1                       
 Lamp Type: LED Retrofit                       
 Bulb Included: Bulb Not Included                       
 Max. Wattage Per Lamp (W): 3                       
 Lamp Base: G9                       
 Input Voltage (V): 120                     

#### LED

#### OPTICAL

#### RATINGS AND CERTIFICATIONS

Certified By: Certified for North American Standards                       
 IP rating: IP20                     

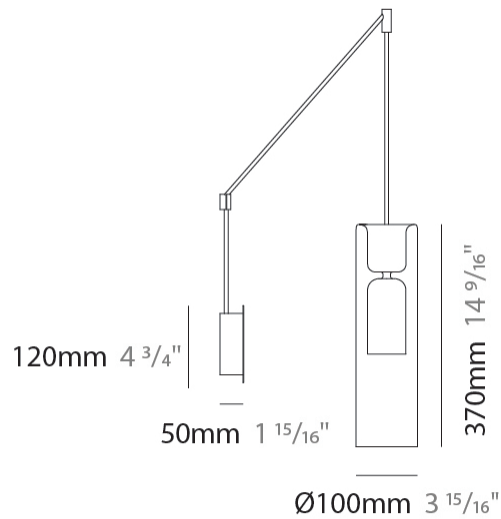

## TAO SURFACE

D143019-

PROJECT

TYPE

SPECIFIER

QUANTITY

DATE

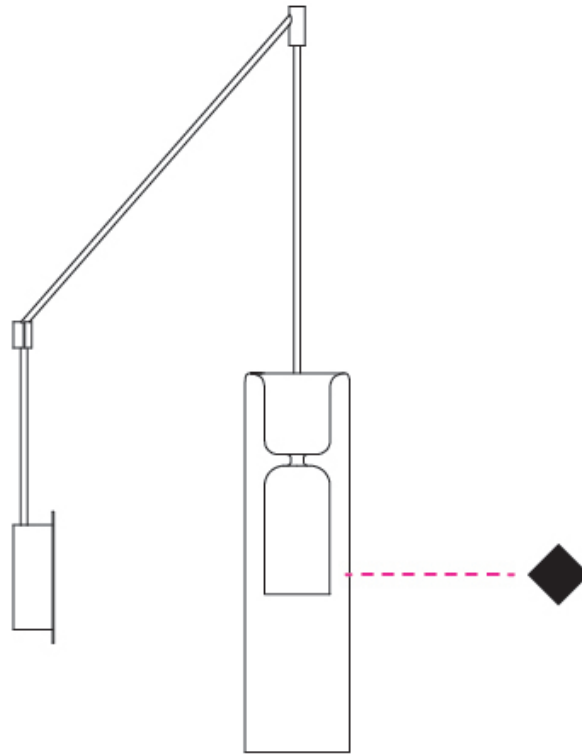

D

|           |       |
|-----------|-------|
| PROJECT   | _____ |
| TYPE      | _____ |
| SPECIFIER | _____ |
| QUANTITY  | _____ |
| DATE      | _____ |

## TAO SURFACE

### D143020-

base number Finish  
Options

- To build a product code in our configurator select the specify button on the base model # product page
- To build a manual product code on this datasheet choose from the options listed below in blue font and add the suffix to the base model #

#### GENERAL

Series: Tao  
 Brand: Cangiini & Tucci  
 Division: Design  
 Mounting Type: Surface  
 Mounting Location: Wall  
 Subcategory: Ambient

#### PHYSICAL

Shape: Cylinder  
 Diameter (mm): 100  
 Diameter (in): 3 <sup>15</sup>/<sub>16</sub>  
 Height (mm): 370  
 Height (in): 14 <sup>9</sup>/<sub>16</sub>  
 Light Distribution: Omnidirectional  
 Weight (kg): 2.40  
 Weight (lbs): 5.29  
 Fixture Finish: [AMB](#) / [GRN](#) / [PNK](#) / [RUB](#) / [SMK](#) / [TOB](#) / [TRA](#) / [RGD](#) / [TIM](#)  
 Holder Finish: CHR  
 Fixture Material: Glass / Metal

#### ELECTRICAL

Number of Lamps: 3  
 Lamp Type: LED Retrofit  
 Bulb Included: Bulb Not Included  
 Total Output Wattage (W): 9  
 Max. Wattage Per Lamp (W): 3  
 Lamp Base: G9  
 Input Voltage (V): 120

#### LED

#### OPTICAL

#### RATINGS AND CERTIFICATIONS

Certified By: Certified for North American Standards  
 IP rating: IP20

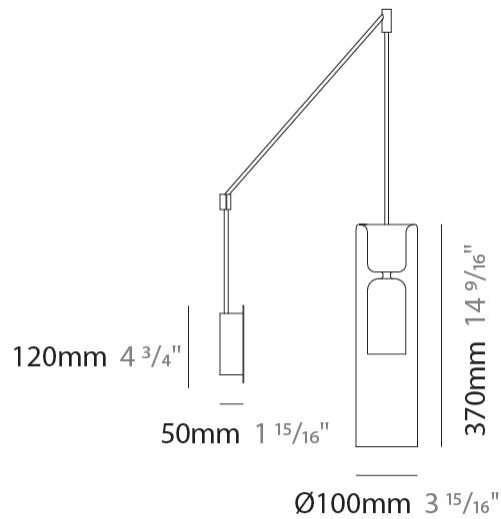

## TAO SURFACE

D143020-

PROJECT

TYPE

SPECIFIER

QUANTITY

DATE

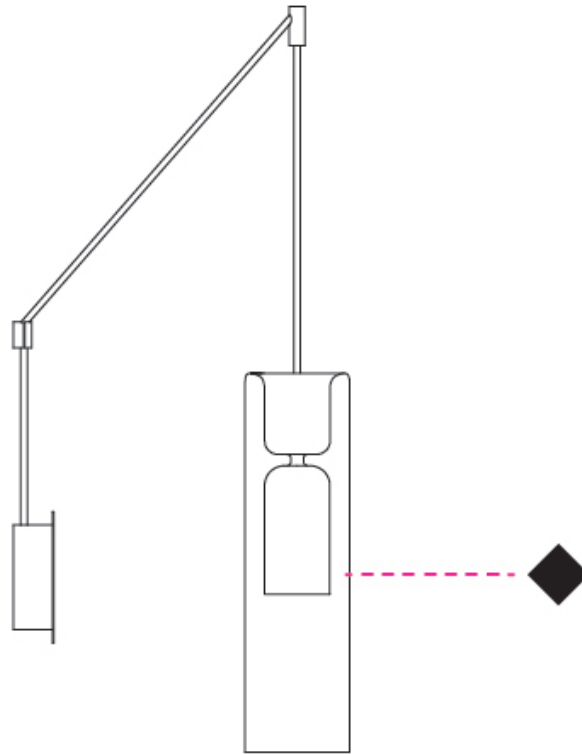

D

## TAO COLOR FINISH CHART

|           |       |
|-----------|-------|
| PROJECT   | _____ |
| TYPE      | _____ |
| SPECIFIER | _____ |
| QUANTITY  | _____ |
| DATE      | _____ |

### Fixture Finish

Amber - AMB



Green - GRN



Pink - PNK



Ruby - RUB



Smoke - SMK



Tobacco - TOB



Transparent - TRA



Rose Gold - RGD



Titanium - TIM



### Holder Finish

Chrome - CHR



Polished Stainless Steel - PSS

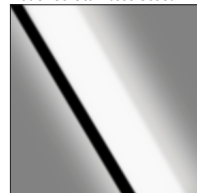

**Digital:** Not all screens are calibrated the same, and therefore, colors will appear differently between screens.

**Physical:** When texture is involved, there will be variations in color, character and tone within a product series and between product families.



|           |  |
|-----------|--|
| PROJECT   |  |
| TYPE      |  |
| SPECIFIER |  |
| QUANTITY  |  |
| DATE      |  |

### LEGEND

|   |  |  |
|---|--|--|
| floor-mounted   | pivotal  | special LED (upon request) RGB, RGBW, tunable, gold+, meat+, art+, fashion+                    |
| wall and ceiling: recessed and surface mounted            | rotating   | warm dim / natural dimming LED   |
| ceiling-mounted and wall-mounted                          | illuminate tilted  | rechargeable battery powered   |
| wall-mounted  | color of suspension cable                                    | fixture with natural vivid LED (upon request)  |
| omni-directional light distribution                       | length of suspension cable                                   | color rendering index  |
| direct light distribution                                 | reflector degree selection                                   | color temperature  |
| direct/indirect light distribution                        | super spot   | lumen (luminous flux)  |
| indirect light distribution                               | lens   | efficacy (lumens per watt)   |
| asymmetric light distribution                             | lens pack  | Unified Glare Rating (UGR) range from 5-40   |
| aura light distribution                                   | shine ring   | marine grade (AISI 316 stainless steel)  |
| round wall or ceiling cut-out                             | integrated shine ring with diffuser                          | walk on  |
| square wall or ceiling cut-out                            | free individual colors 01-29                                 | drive on   |
| the supplied jig specifies the cutout dimensions          | individual colors: 00 (free of charge), 01-25 (extra charge) | Dark Sky Compliance  |
| minimum distance (meters) lamp - object                   | luminaire part to be colored (F1)                            | Americans with Disabilities Act (less than 4" off the wall located between 27"-84" from floor) |
| recessed depth  | luminaire part to be colored (F2)                            | lamp protected against explosion   |
| ceiling thickness in mm                                   | luminaire part to be colored (F3)                            | blown glass using traditional methods by master glass blower                                   |
| ceiling thickness selection                               | luminaire part to be colored (F4)                            | acoustic material  |
| dimmable DP (phase), DV (0-10V), DD (dali), DS (step-dim) | luminaire part to be colored (F5)                            | protection class I, protection insulation  |
| included or excluded LED driver/transformer/control gear  | color of 3-circuit adaptor                                   | protection class II, protection insulation   |
| separately switchable                                     | indirect diffuser  | ETL Certified to UL and CSA Standards  |
| sensor  | direct diffuser  | UL Certified to UL and CSA Standards   |
| remote control  | ball-proof (upon request)                                    | CSA Certified to UL and CSA Standards  |
| available upon request                                    | accessory  | Certified for North American Standards   |

### IP RATING

|      |  |
|------|--|
| IP20 | protected against ingress of solid bodies greater than 12.5mm (finger)   |
| IP33 | protected against ingress of solid bodies greater than 2.5mm<br>protected against sprays of water up to 60 degrees from the vertical (rain)      |
| IP40 | protected against ingress of solid bodies greater than 1mm (wire)<br>no protection against the ingress of moisture                               |
| IP43 | protected against ingress of solid bodies greater than 1mm (wire)<br>protected against sprays of water up to 60 degrees from the vertical (rain) |
| IP44 | protected against ingress of solid bodies greater than 1mm (wire)<br>protected against water splashed from all directions                        |
| IP54 | protected against limited ingress of dust (wet rooms/covered outdoor areas)<br>protected against water splashed from all directions              |
| IP65 | protected against ingress of dust<br>protected against jets of water   |
| IP66 | protected against ingress of dust<br>protected against powerful jets of water or heavy seas  |
| IP67 | protected against ingress of dust<br>protected against immersion of water between 15cm - 1m for 30 minutes                                       |
| IP68 | protected against ingress of dust<br>protected against immersion of water under pressure for long periods  |

### IK RATING

|      |   |
|------|---|
| IK01 | protected against 0.14 joules impact (equivalent to 0.25kg mass dropped from 56mm above the surface)  |
| IK02 | protected against 0.2 joules impact (equivalent to 0.25kg mass dropped from 80mm above the surface)   |
| IK03 | protected against 0.35 joules impact (equivalent to 0.25kg mass dropped from 140mm above the surface) |
| IK04 | protected against 0.5 joules impact (equivalent to 0.25kg mass dropped from 200mm above the surface)  |
| IK05 | protected against 0.7 joules impact (equivalent to 0.25kg mass dropped from 280mm above the surface)  |
| IK06 | protected against 1 joules impact (equivalent to 0.25kg mass dropped from 400mm above the surface)    |
| IK07 | protected against 2 joules impact (equivalent to 0.5kg mass dropped from 400mm above the surface)     |
| IK08 | protected against 5 joules impact (equivalent to 1.7kg mass dropped from 300mm above the surface)     |
| IK09 | protected against 10 joules impact (equivalent to 5.0kg mass dropped from 200mm above the surface)    |
| IK10 | protected against 20 joules impact (equivalent to 5.0kg mass dropped from 400mm above the surface)    |