

PROJECT	
TYPE	
SPECIFIER	
QUANTITY	
DATE	

## TAO MONOPOINT SUSPENSION

### D141111-

base number                      Finish                       
Options                     

- To build a product code in our configurator select the specify button on the base model # product page
- To build a manual product code on this datasheet choose from the options listed below in blue font and add the suffix to the base model #

#### GENERAL

Series: Tao                       
 Subseries: Tao Monopoint                       
 Brand: Cangini & Tucci                       
 Division: Design                       
 Mounting Type: Suspension                       
 Mounting Location: Ceiling                       
 Subcategory: Pendant                     

#### PHYSICAL

Shape: Cylinder                       
 Diameter (mm): 80                       
 Diameter (in): 3 1/8                       
 Height (mm): 300                       
 Height (in): 11 13/16                       
 Max. Overall Height (mm): 1800                       
 Max. Overall Height (in): 70 7/8                       
 Light Distribution: Omnidirectional                       
 Weight (kg): 0.80                       
 Weight (lbs): 1.76                       
 Fixture Finish: [AMB / GRN / PNK / RUB / SMK / TOB / TRA / RGD / TIM](#)                       
 Holder Finish: CHR                       
 Fixture Material: Glass / Metal                       
 Cable Details: 1500mm Cable                     

#### ELECTRICAL

Number of Lamps: 1                       
 Lamp Type: LED Retrofit                       
 Bulb Included: Bulb Not Included                       
 Max. Wattage Per Lamp (W): 3                       
 Lamp Base: G9                       
 Input Voltage (V): 120                       
 Upon Request: GU24 / 277Vac                     

#### LED

#### OPTICAL

#### RATINGS AND CERTIFICATIONS

Certified By: Certified for North American Standards                       
 IP rating: IP20                     

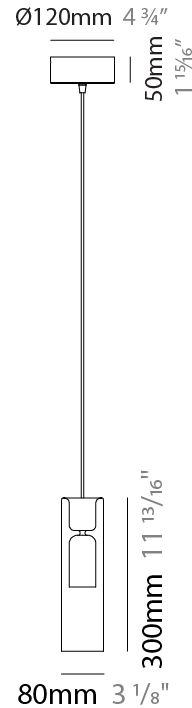

## TAO MONOPOINT SUSPENSION

D141111-

PROJECT

TYPE

SPECIFIER

QUANTITY

DATE

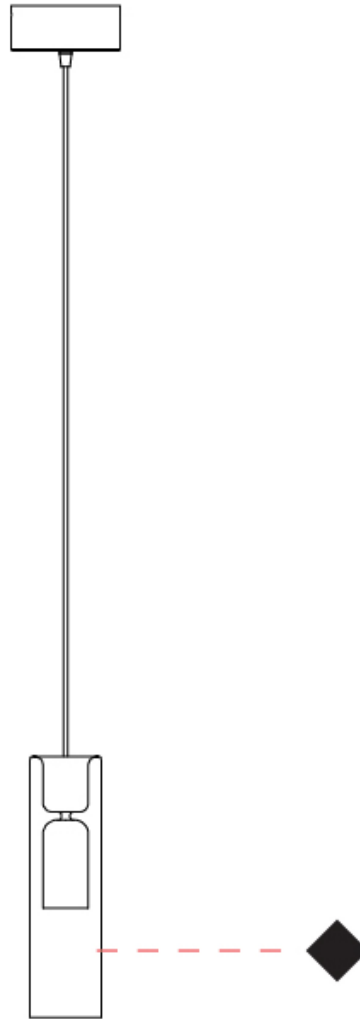

D

PROJECT	_____
TYPE	_____
SPECIFIER	_____
QUANTITY	_____
DATE	_____

## TAO MONOPOINT SUSPENSION

### D141112-

base number            Finish             
Options           

- To build a product code in our configurator select the specify button on the base model # product page
- To build a manual product code on this datasheet choose from the options listed below in blue font and add the suffix to the base model #

#### GENERAL

Series: Tao             
 Subseries: Tao Monopoint             
 Brand: Cangini & Tucci             
 Division: Design             
 Mounting Type: Suspension             
 Mounting Location: Ceiling             
 Subcategory: Pendant           

#### PHYSICAL

Shape: Cylinder             
 Diameter (mm): 100             
 Diameter (in): 3 <sup>15</sup>/<sub>16</sub>             
 Height (mm): 370             
 Height (in): 14 <sup>9</sup>/<sub>16</sub>             
 Max. Overall Height (mm): 1870             
 Max. Overall Height (in): 73 <sup>5</sup>/<sub>8</sub>             
 Light Distribution: Omnidirectional             
 Weight (kg): 1.5             
 Weight (lbs): 3.31             
 Fixture Finish: AMB / GRN / PNK / RUB / SMK / TOB / TRA / RGD / TIM             
 Holder Finish: CHR             
 Fixture Material: Glass / Metal             
 Cable Details: 1500mm Cable           

#### ELECTRICAL

Number of Lamps: 1             
 Lamp Type: LED Retrofit             
 Bulb Included: Bulb Not Included             
 Max. Wattage Per Lamp (W): 8             
 Lamp Base: E26             
 Input Voltage (V): 120             
 Upon Request: GU24 / 277Vac           

#### LED

#### OPTICAL

#### RATINGS AND CERTIFICATIONS

Certified By: Certified for North American Standards             
 IP rating: IP20           

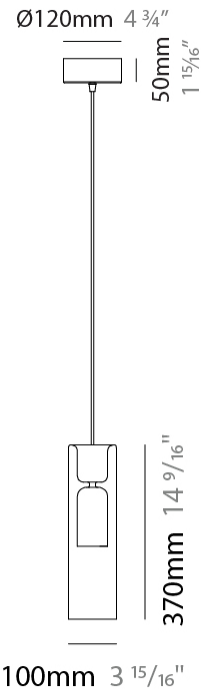

## TAO MONOPOINT SUSPENSION

D141112-

PROJECT

TYPE

SPECIFIER

QUANTITY

DATE

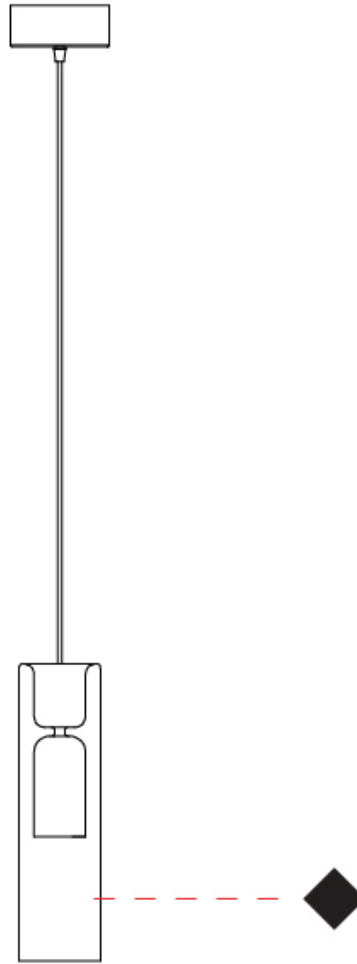

D

PROJECT	_____
TYPE	_____
SPECIFIER	_____
QUANTITY	_____
DATE	_____

## TAO 2 LIGHT SWAG SUSPENSION

### D141115-

base number                      Finish                       
Options                     

- To build a product code in our configurator select the specify button on the base model # product page
- To build a manual product code on this datasheet choose from the options listed below in blue font and add the suffix to the base model #

#### GENERAL

Series: Tao                       
 Subseries: Tao 2 Light Swag                       
 Brand: Cangini & Tucci                       
 Division: Design                       
 Mounting Type: Suspension                       
 Mounting Location: Ceiling                       
 Subcategory: Pendant                     

#### PHYSICAL

Shape: Cylinder                       
 Diameter (mm): 80                       
 Diameter (in): 3 1/8                       
 Height (mm): 300                       
 Height (in): 11 13/16                       
 Max. Overall Height (mm): 2300                       
 Max. Overall Height (in): 90 9/16                       
 Light Distribution: Omnidirectional                       
 Weight (kg): 1.5                       
 Weight (lbs): 3.31                       
 Fixture Finish: AMB / GRN / PNK / RUB / SMK / TOB / TRA / RGD / TIM  
 Holder Finish: CHR                       
 Fixture Material: Glass / Metal                       
 Cable Details: 2000mm Cable                     

#### ELECTRICAL

Number of Lamps: 2                       
 Lamp Type: LED Retrofit                       
 Bulb Included: Bulb Not Included                       
 Total Output Wattage (W): 6                       
 Max. Wattage Per Lamp (W): 3                       
 Lamp Base: G9                       
 Input Voltage (V): 120                     

#### LED

#### OPTICAL

#### RATINGS AND CERTIFICATIONS

Certified By: Certified for North American Standards                       
 IP rating: IP20                     

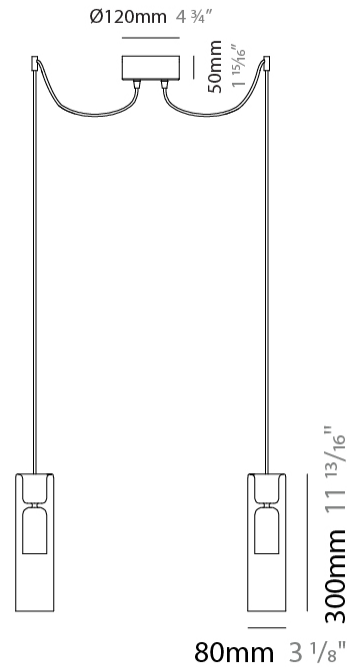

## TAO 2 LIGHT SWAG SUSPENSION

D141115-

PROJECT \_\_\_\_\_

TYPE \_\_\_\_\_

SPECIFIER \_\_\_\_\_

QUANTITY \_\_\_\_\_

DATE \_\_\_\_\_

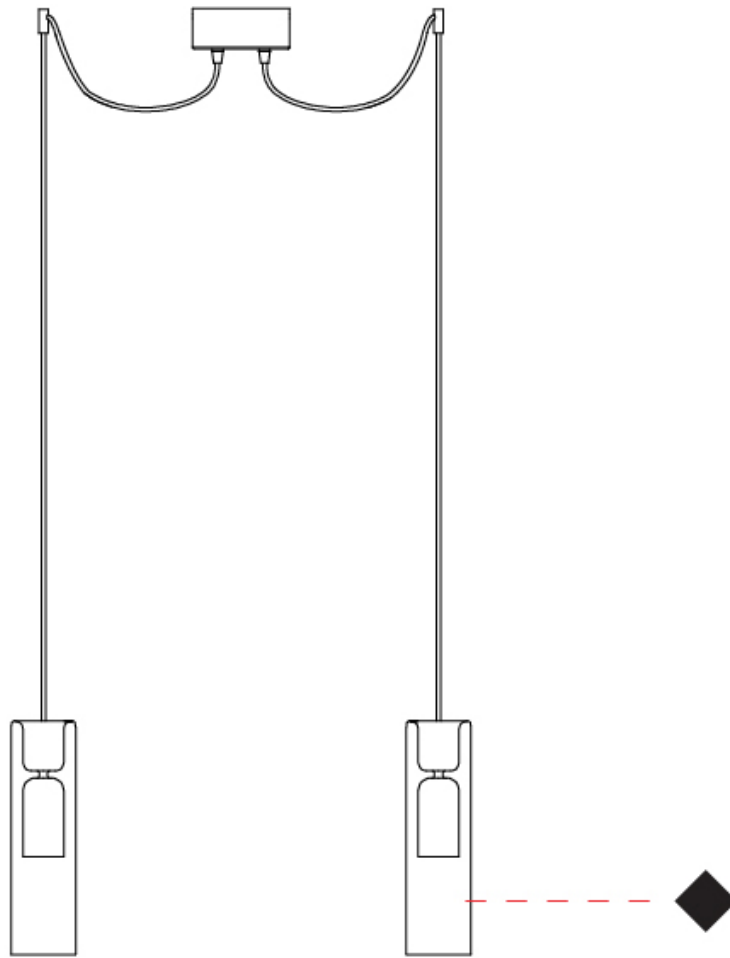

D

PROJECT	_____
TYPE	_____
SPECIFIER	_____
QUANTITY	_____
DATE	_____

## TAO 2 LIGHT SWAG SUSPENSION

### D141116-

base number Finish  
Options

- To build a product code in our configurator select the specify button on the base model # product page
- To build a manual product code on this datasheet choose from the options listed below in blue font and add the suffix to the base model #

#### GENERAL

Series: Tao  
 Subseries: Tao 2 Light Swag  
 Brand: Cangini & Tucci  
 Division: Design  
 Mounting Type: Suspension  
 Mounting Location: Ceiling  
 Subcategory: Pendant

#### PHYSICAL

Shape: Cylinder  
 Diameter (mm): 100  
 Diameter (in): 3 <sup>15</sup>/<sub>16</sub>  
 Height (mm): 370  
 Height (in): 14 <sup>9</sup>/<sub>16</sub>  
 Max. Overall Height (mm): 1870  
 Max. Overall Height (in): 73 <sup>5</sup>/<sub>8</sub>  
 Light Distribution: Omnidirectional  
 Weight (kg): 3.2  
 Weight (lbs): 7.05  
 Fixture Finish: [AMB](#) / [GRN](#) / [PNK](#) / [RUB](#) / [SMK](#) / [TOB](#) / [TRA](#) / [RGD](#) / [TIM](#)  
 Holder Finish: CHR  
 Fixture Material: Glass / Metal  
 Cable Details: 1500mm Cable

#### ELECTRICAL

Number of Lamps: 2  
 Lamp Type: LED Retrofit  
 Bulb Included: Bulb Not Included  
 Total Output Wattage (W): 16  
 Max. Wattage Per Lamp (W): 8  
 Lamp Base: E26  
 Input Voltage (V): 120  
 Upon Request: GU24 / 277Vac

#### LED

#### OPTICAL

#### RATINGS AND CERTIFICATIONS

Certified By: Certified for North American Standards  
 IP rating: IP20

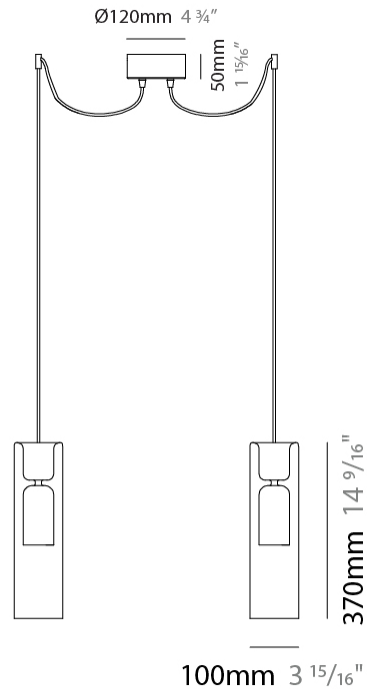

## TAO 2 LIGHT SWAG SUSPENSION

D141116-

PROJECT \_\_\_\_\_

TYPE \_\_\_\_\_

SPECIFIER \_\_\_\_\_

QUANTITY \_\_\_\_\_

DATE \_\_\_\_\_

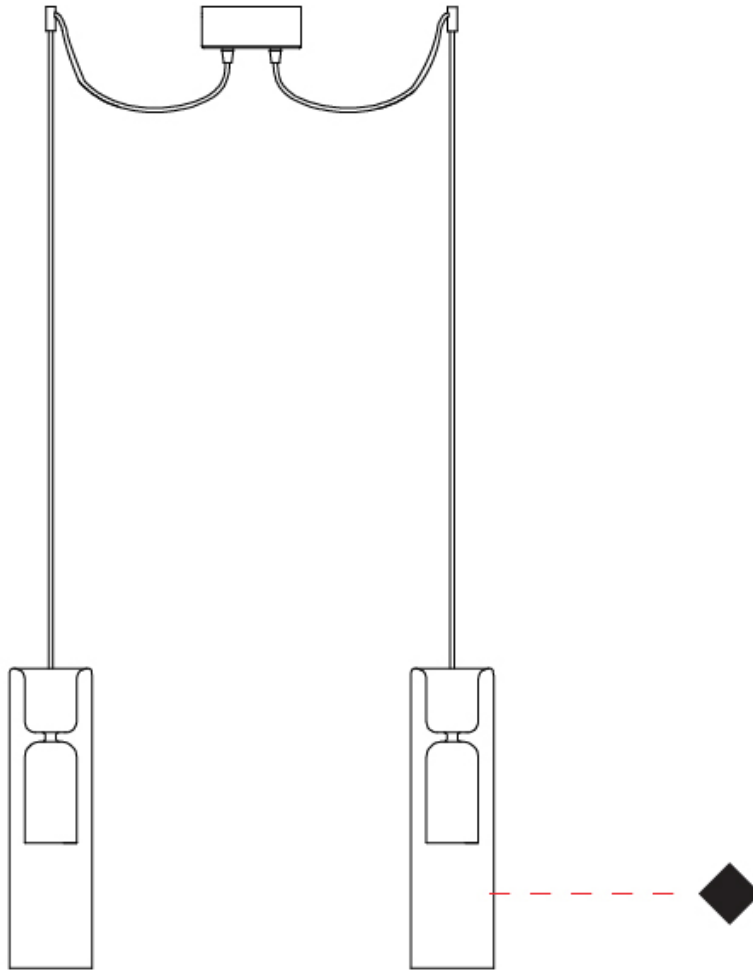

D



PROJECT
TYPE
SPECIFIER
QUANTITY
DATE

## TAO 6 LIGHT CLUSTER SUSPENSION

### D141117-

base number                      Finish                       
Options                     

- To build a product code in our configurator select the specify button on the base model # product page
- To build a manual product code on this datasheet choose from the options listed below in blue font and add the suffix to the base model #

#### GENERAL

Series: Tao                       
 Subseries: Tao 6 Light Cluster                       
 Brand: Cangini & Tucci                       
 Division: Design                       
 Mounting Type: Suspension                       
 Mounting Location: Ceiling                       
 Subcategory: Pendant                     

#### PHYSICAL

Shape: Cylinder                       
 Diameter (mm): 270                       
 Diameter (in): 10 <sup>5</sup>/<sub>8</sub>                       
 Max. Overall Height (mm): 1500                       
 Max. Overall Height (in): 59 <sup>1</sup>/<sub>16</sub>                       
 Light Distribution: Omnidirectional                       
 Weight (kg): 5.25                       
 Weight (lbs): 11.5                       
 Fixture Finish: [AMB](#) / [GRN](#) / [PNK](#) / [RUB](#) / [SMK](#) / [TOB](#) / [TRA](#) / [RGD](#) / [TIM](#)                       
 Holder Finish: PSS                       
 Fixture Material: Glass / Metal                       
 Cable Details: 1500mm Cable                     

#### ELECTRICAL

Number of Lamps: 6                       
 Lamp Type: LED Retrofit                       
 Bulb Included: Bulb Not Included                       
 Total Output Wattage (W): 18                       
 Max. Wattage Per Lamp (W): 3                       
 Lamp Base: G9                       
 Input Voltage (V): 120                     

#### LED

#### OPTICAL

#### RATINGS AND CERTIFICATIONS

Certified By: Certified for North American Standards                       
 IP rating: IP20                     



270mm 10 <sup>5</sup>/<sub>8</sub>"

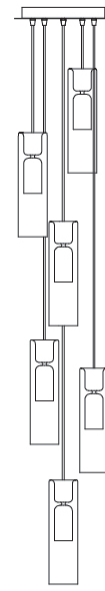

300mm 11 <sup>13</sup>/<sub>16</sub>"

Ø80mm 3 <sup>1</sup>/<sub>8</sub>"



## TAO 6 LIGHT CLUSTER SUSPENSION

D141117-

PROJECT

TYPE

SPECIFIER

QUANTITY

DATE

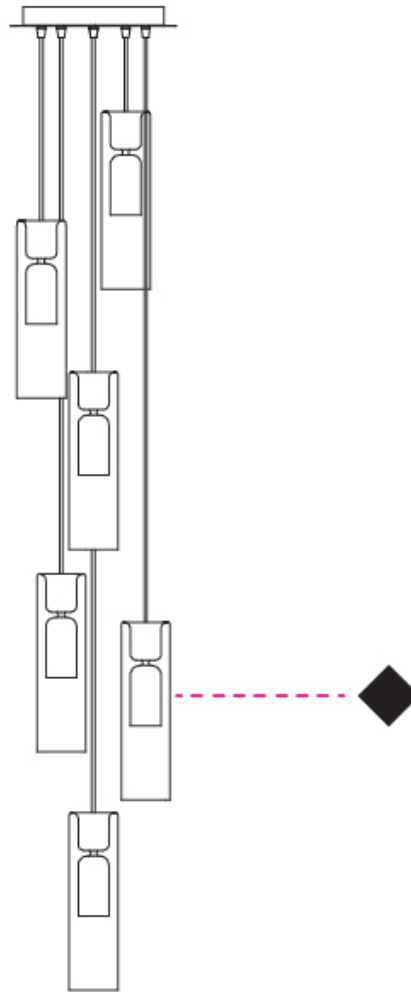

D

PROJECT
TYPE
SPECIFIER
QUANTITY
DATE

## TAO 3 LIGHT CLUSTER SUSPENSION

### D141118-

base number Finish  
Options

- To build a product code in our configurator select the specify button on the base model # product page
- To build a manual product code on this datasheet choose from the options listed below in blue font and add the suffix to the base model #

#### GENERAL

Series: Tao  
 Subseries: Tao 3 Light Cluster  
 Brand: Cangini & Tucci  
 Division: Design  
 Mounting Type: Suspension  
 Mounting Location: Ceiling  
 Subcategory: Pendant

#### PHYSICAL

Shape: Cylinder  
 Diameter (mm): 270  
 Diameter (in): 10 <sup>5</sup>/<sub>8</sub>  
 Height (mm): 1500  
 Height (in): 59 <sup>1</sup>/<sub>16</sub>  
 Light Distribution: Omnidirectional  
 Weight (kg): 5.60  
 Weight (lbs): 12.34  
 Fixture Finish: [AMB](#) / [GRN](#) / [PNK](#) / [RUB](#) / [SMK](#) / [TOB](#) / [TRA](#) / [RGD](#) / [TIM](#)  
 Holder Finish: PSS  
 Fixture Material: Glass / Metal  
 Cable Details: 1500mm Cable

#### ELECTRICAL

Number of Lamps: 3  
 Lamp Type: LED Retrofit  
 Bulb Included: Bulb Not Included  
 Total Output Wattage (W): 24  
 Max. Wattage Per Lamp (W): 8  
 Lamp Base: G9  
 Input Voltage (V): 120

#### LED

#### OPTICAL

#### RATINGS AND CERTIFICATIONS

Certified By: Certified for North American Standards  
 IP rating: IP20



270mm 10 <sup>5</sup>/<sub>8</sub>"

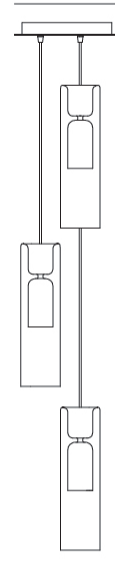

370mm 14 <sup>9</sup>/<sub>16</sub>"

Ø100mm 3 <sup>15</sup>/<sub>16</sub>"



## TAO 3 LIGHT CLUSTER SUSPENSION

D141118-

PROJECT \_\_\_\_\_

TYPE \_\_\_\_\_

SPECIFIER \_\_\_\_\_

QUANTITY \_\_\_\_\_

DATE \_\_\_\_\_

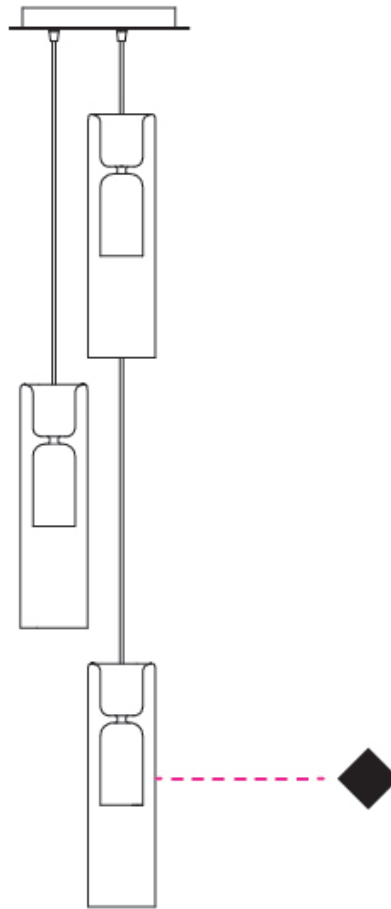

D

PROJECT
TYPE
SPECIFIER
QUANTITY
DATE

## TAO 3 LIGHT LINEAR SUSPENSION

### D141120-

base number Finish  
Options

- To build a product code in our configurator select the specify button on the base model # product page
- To build a manual product code on this datasheet choose from the options listed below in blue font and add the suffix to the base model #

#### GENERAL

Series: Tao  
 Subseries: Tao 3 Light Linear  
 Brand: Cangini & Tucci  
 Division: Design  
 Mounting Type: Suspension  
 Mounting Location: Ceiling  
 Subcategory: Pendant

#### PHYSICAL

Shape: Cylinder  
 Length (mm): 700  
 Length (in): 27 <sup>9</sup>/<sub>16</sub>"  
 Height (mm): 1500  
 Height (in): 59 <sup>1</sup>/<sub>16</sub>"  
 Light Distribution: Omnidirectional  
 Weight (kg): 6.90  
 Weight (lbs): 15.21  
 Fixture Finish: [AMB](#) / [GRN](#) / [PNK](#) / [RUB](#) / [SMK](#) / [TOB](#) / [TRA](#) / [RGD](#) / [TIM](#)  
 Holder Finish: PSS  
 Fixture Material: Glass / Metal  
 Cable Details: 1500mm Cable

#### ELECTRICAL

Number of Lamps: 3  
 Lamp Type: LED Retrofit  
 Bulb Included: Bulb Not Included  
 Total Output Wattage (W): 24  
 Max. Wattage Per Lamp (W): 8  
 Lamp Base: G9  
 Input Voltage (V): 120

#### LED

#### OPTICAL

#### RATINGS AND CERTIFICATIONS

Certified By: Certified for North American Standards  
 IP rating: IP20

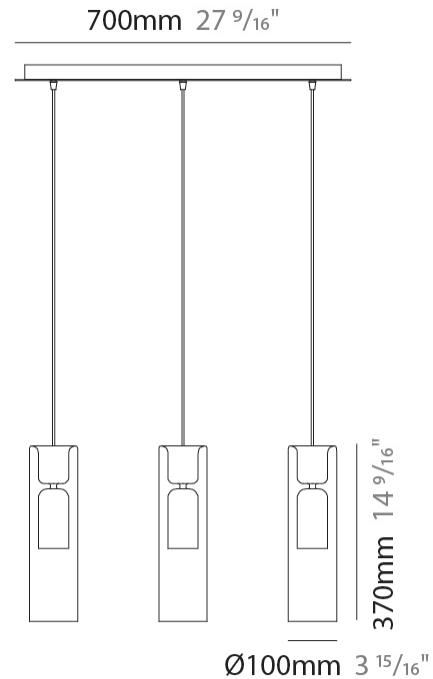

## TAO 3 LIGHT LINEAR SUSPENSION

D141120-

PROJECT \_\_\_\_\_

TYPE \_\_\_\_\_

SPECIFIER \_\_\_\_\_

QUANTITY \_\_\_\_\_

DATE \_\_\_\_\_

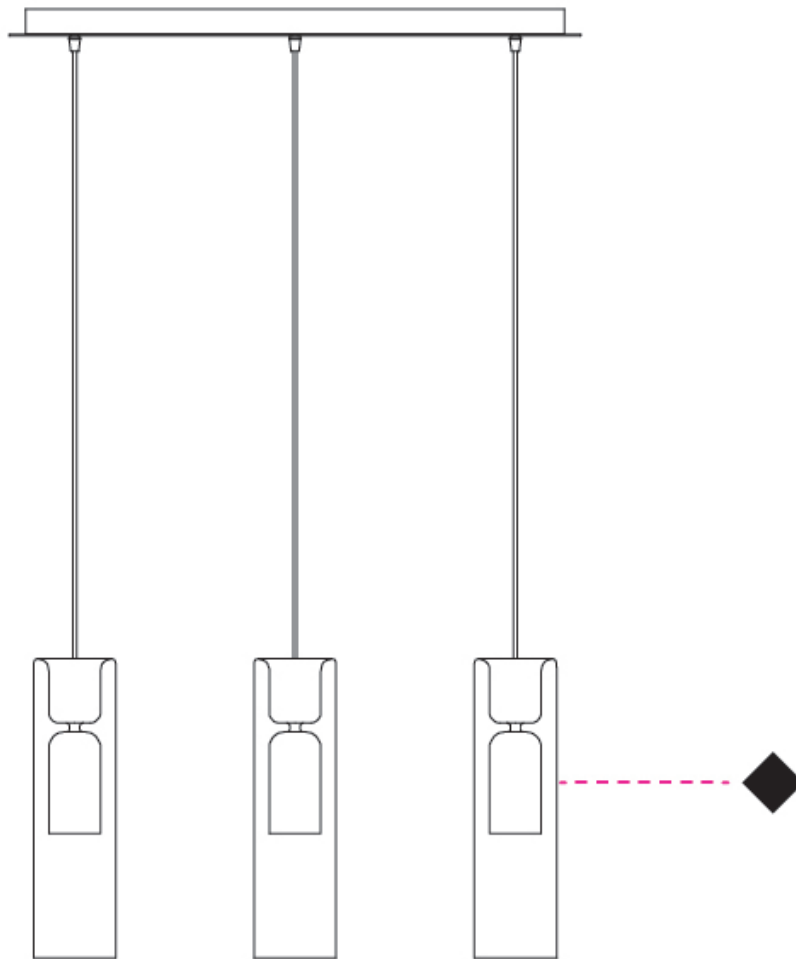

D

PROJECT	
TYPE	
SPECIFIER	
QUANTITY	
DATE	

## TAO SURFACE

### D143018-

base number Finish  
Options

- To build a product code in our configurator select the specify button on the base model # product page
- To build a manual product code on this datasheet choose from the options listed below in blue font and add the suffix to the base model #

#### GENERAL

Series: Tao  
 Brand: Cangiini & Tucci  
 Division: Design  
 Mounting Type: Surface  
 Mounting Location: Wall  
 Subcategory: Ambient

#### PHYSICAL

Shape: Cylinder  
 Diameter (mm): 80  
 Diameter (in): 3 1/8  
 Height (mm): 330  
 Depth (mm): 160  
 Height (in): 13  
 Depth (in): 6 5/16  
 Extension (mm): 160  
 Extension (in): 6 5/16  
 Light Distribution: Omnidirectional  
 Weight (kg): 1.075  
 Weight (lbs): 2.37  
 Fixture Finish: [AMB](#) / [GRN](#) / [PNK](#) / [RUB](#) / [SMK](#) / [TOB](#) / [TRA](#) / [RGD](#) / [TIM](#)  
 Holder Finish: CHR  
 Fixture Material: Glass / Metal

#### ELECTRICAL

Number of Lamps: 1  
 Lamp Type: LED Retrofit  
 Bulb Included: Bulb Not Included  
 Max. Wattage Per Lamp (W): 3  
 Lamp Base: G9  
 Input Voltage (V): 120

#### LED

#### OPTICAL

#### RATINGS AND CERTIFICATIONS

Certified By: Certified for North American Standards  
 IP rating: IP20

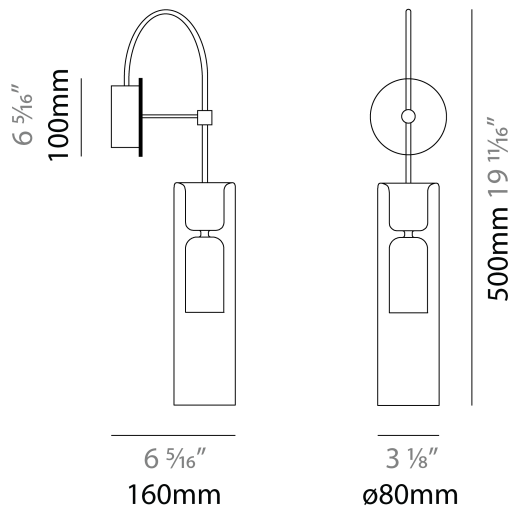

## TAO SURFACE

D143018-

PROJECT	_____
TYPE	_____
SPECIFIER	_____
QUANTITY	_____
DATE	_____

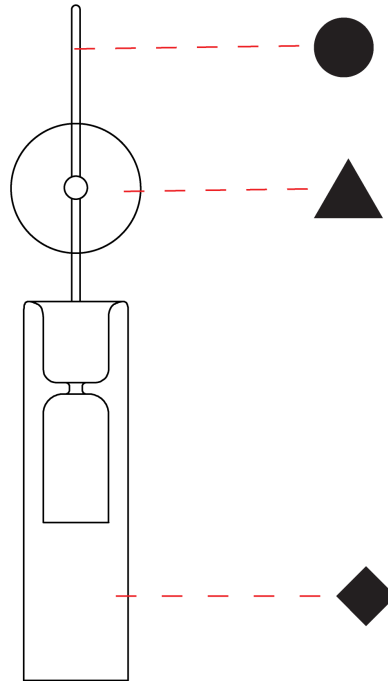



PROJECT
TYPE
SPECIFIER
QUANTITY
DATE

## TAO SURFACE

### D143019-

base number                      Finish                       
Options                     

- To build a product code in our configurator select the specify button on the base model # product page
- To build a manual product code on this datasheet choose from the options listed below in blue font and add the suffix to the base model #

#### GENERAL

Series: Tao                       
 Brand: Cangini & Tucci                       
 Division: Design                       
 Mounting Type: Surface                       
 Mounting Location: Wall                       
 Subcategory: Ambient                     

#### PHYSICAL

Shape: Cylinder                       
 Diameter (mm): 100                       
 Diameter (in): 3 <sup>15</sup>/<sub>16</sub>                       
 Height (mm): 370                       
 Height (in): 14 <sup>9</sup>/<sub>16</sub>                       
 Light Distribution: Omnidirectional                       
 Weight (kg): 0.90                       
 Weight (lbs): 1.98                       
 Fixture Finish: [AMB](#) / [GRN](#) / [PNK](#) / [RUB](#) / [SMK](#) / [TOB](#) / [TRA](#) / [RGD](#) / [TIM](#)                       
 Holder Finish: CHR                       
 Fixture Material: Glass / Metal                     

#### ELECTRICAL

Number of Lamps: 1                       
 Lamp Type: LED Retrofit                       
 Bulb Included: Bulb Not Included                       
 Max. Wattage Per Lamp (W): 3                       
 Lamp Base: G9                       
 Input Voltage (V): 120                     

#### LED

#### OPTICAL

#### RATINGS AND CERTIFICATIONS

Certified By: Certified for North American Standards                       
 IP rating: IP20                     

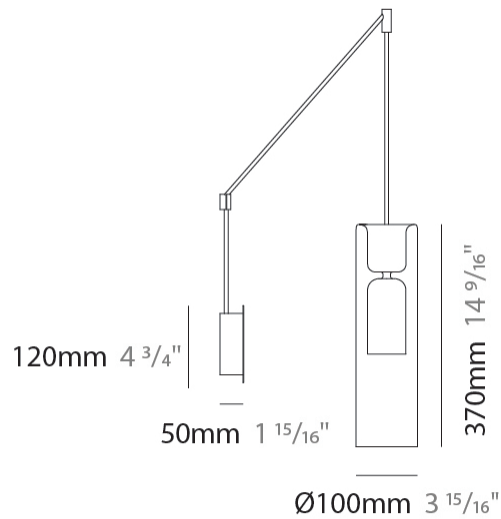

## TAO SURFACE

D143019-

PROJECT \_\_\_\_\_

TYPE \_\_\_\_\_

SPECIFIER \_\_\_\_\_

QUANTITY \_\_\_\_\_

DATE \_\_\_\_\_

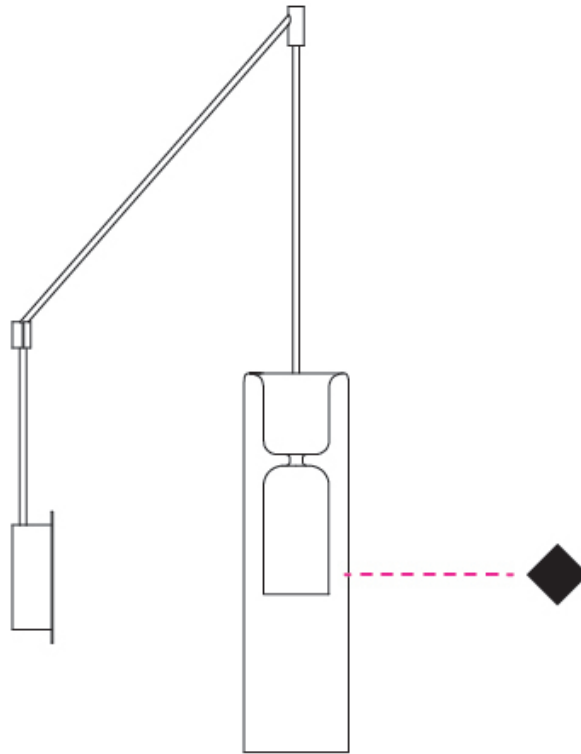

D

PROJECT	_____
TYPE	_____
SPECIFIER	_____
QUANTITY	_____
DATE	_____

## TAO SURFACE

### D143020-

base number                      Finish                       
Options                     

- To build a product code in our configurator select the specify button on the base model # product page
- To build a manual product code on this datasheet choose from the options listed below in blue font and add the suffix to the base model #

#### GENERAL

Series: Tao \_\_\_\_\_  
 Brand: Cangiini & Tucci \_\_\_\_\_  
 Division: Design \_\_\_\_\_  
 Mounting Type: Surface \_\_\_\_\_  
 Mounting Location: Wall \_\_\_\_\_  
 Subcategory: Ambient \_\_\_\_\_

#### PHYSICAL

Shape: Cylinder \_\_\_\_\_  
 Diameter (mm): 100 \_\_\_\_\_  
 Diameter (in): 3 <sup>15</sup>/<sub>16</sub> \_\_\_\_\_  
 Height (mm): 370 \_\_\_\_\_  
 Height (in): 14 <sup>9</sup>/<sub>16</sub> \_\_\_\_\_  
 Light Distribution: Omnidirectional \_\_\_\_\_  
 Weight (kg): 2.40 \_\_\_\_\_  
 Weight (lbs): 5.29 \_\_\_\_\_  
 Fixture Finish: [AMB](#) / [GRN](#) / [PNK](#) / [RUB](#) / [SMK](#) / [TOB](#) / [TRA](#) / [RGD](#) / [TIM](#) \_\_\_\_\_  
 Holder Finish: CHR \_\_\_\_\_  
 Fixture Material: Glass / Metal \_\_\_\_\_

#### ELECTRICAL

Number of Lamps: 3 \_\_\_\_\_  
 Lamp Type: LED Retrofit \_\_\_\_\_  
 Bulb Included: Bulb Not Included \_\_\_\_\_  
 Total Output Wattage (W): 9 \_\_\_\_\_  
 Max. Wattage Per Lamp (W): 3 \_\_\_\_\_  
 Lamp Base: G9 \_\_\_\_\_  
 Input Voltage (V): 120 \_\_\_\_\_

#### LED

#### OPTICAL

#### RATINGS AND CERTIFICATIONS

Certified By: Certified for North American Standards \_\_\_\_\_  
 IP rating: IP20 \_\_\_\_\_

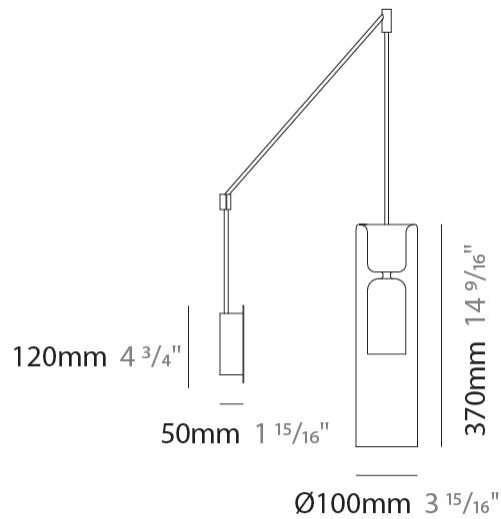

## TAO SURFACE

D143020-

PROJECT

TYPE

SPECIFIER

QUANTITY

DATE

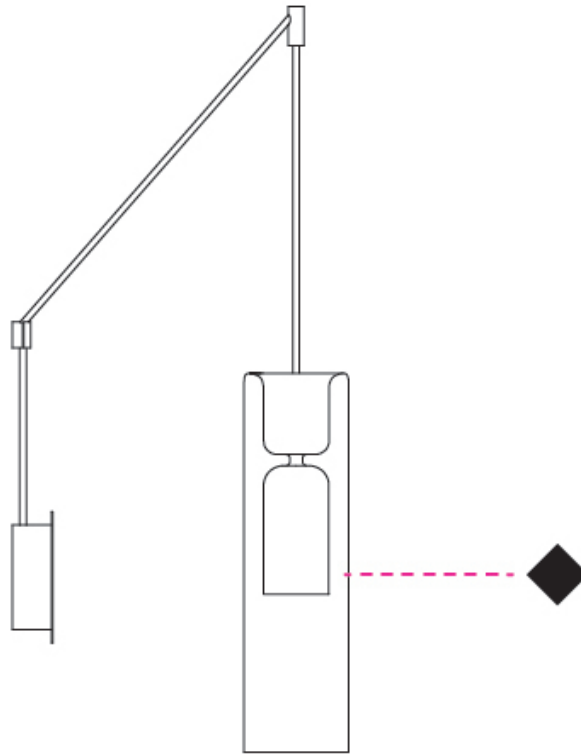

D

## TAO

### COLOR FINISH CHART

#### Fixture Finish

Amber - AMB



Green - GRN



Pink - PNK



Ruby - RUB



Smoke - SMK



Tobacco - TOB



Transparent - TRA



Rose Gold - RGD

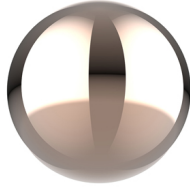

Titanium - TIM



#### Holder Finish

Chrome - CHR



Polished Stainless Steel - PSS



**Digital:** Not all screens are calibrated the same, and therefore, colors will appear differently between screens.

**Physical:** When texture is involved, there will be variations in color, character and tone within a product series and between product families.



PROJECT	
TYPE	
SPECIFIER	
QUANTITY	
DATE	

### LEGEND

floor-mounted	pivotable	special LED (upon request) RGB, RGBW, tunable, gold+, meat+, art+, fashion+
wall and ceiling: recessed and surface mounted	rotating	warm dim / natural dimming LED
ceiling-mounted and wall-mounted	illuminate tilted	rechargeable battery powered
wall-mounted	color of suspension cable	fixture with natural vivid LED (upon request)
omni-directional light distribution	length of suspension cable	color rendering index
direct light distribution	reflector degree selection	color temperature
direct/indirect light distribution	super spot	lumen (luminous flux)
indirect light distribution	lens	efficacy (lumens per watt)
asymmetric light distribution	lens pack	Unified Glare Rating (UGR) range from 5-40
aura light distribution	shine ring	marine grade (AISI 316 stainless steel)
round wall or ceiling cut-out	integrated shine ring with diffuser	walk on
square wall or ceiling cut-out	free individual colors 01-29	drive on
the supplied jig specifies the cutout dimensions	individual colors: 00 (free of charge), 01-25 (extra charge)	Dark Sky Compliance
minimum distance (meters) lamp - object	luminaire part to be colored (F1)	Americans with Disabilities Act (less than 4" off the wall located between 27"-84" from floor)
recessed depth	luminaire part to be colored (F2)	lamp protected against explosion
ceiling thickness in mm	luminaire part to be colored (F3)	blown glass using traditional methods by master glass blower
ceiling thickness selection	luminaire part to be colored (F4)	acoustic material
dimmable DP (phase), DV (0-10V), DD (dali), DS (step-dim)	luminaire part to be colored (F5)	protection class I, protection insulation
included or excluded LED driver/transformer/control gear	color of 3-circuit adaptor	protection class II, protection insulation
separately switchable	indirect diffuser	ETL Certified to UL and CSA Standards
sensor	direct diffuser	UL Certified to UL and CSA Standards
remote control	ball-proof (upon request)	CSA Certified to UL and CSA Standards
available upon request	accessory	Certified for North American Standards

### IP RATING

IP20	protected against ingress of solid bodies greater than 12.5mm (finger)
IP33	protected against ingress of solid bodies greater than 2.5mm protected against sprays of water up to 60 degrees from the vertical (rain)
IP40	protected against ingress of solid bodies greater than 1mm (wire) no protection against the ingress of moisture
IP43	protected against ingress of solid bodies greater than 1mm (wire) protected against sprays of water up to 60 degrees from the vertical (rain)
IP44	protected against ingress of solid bodies greater than 1mm (wire) protected against water splashed from all directions
IP54	protected against limited ingress of dust (wet rooms/covered outdoor areas) protected against water splashed from all directions
IP65	protected against ingress of dust protected against jets of water
IP66	protected against ingress of dust protected against powerful jets of water or heavy seas
IP67	protected against ingress of dust protected against immersion of water between 15cm - 1m for 30 minutes
IP68	protected against ingress of dust protected against immersion of water under pressure for long periods

### IK RATING

IK01	protected against 0.14 joules impact (equivalent to 0.25kg mass dropped from 56mm above the surface)
IK02	protected against 0.2 joules impact (equivalent to 0.25kg mass dropped from 80mm above the surface)
IK03	protected against 0.35 joules impact (equivalent to 0.25kg mass dropped from 140mm above the surface)
IK04	protected against 0.5 joules impact (equivalent to 0.25kg mass dropped from 200mm above the surface)
IK05	protected against 0.7 joules impact (equivalent to 0.25kg mass dropped from 280mm above the surface)
IK06	protected against 1 joules impact (equivalent to 0.25kg mass dropped from 400mm above the surface)
IK07	protected against 2 joules impact (equivalent to 0.5kg mass dropped from 400mm above the surface)
IK08	protected against 5 joules impact (equivalent to 1.7kg mass dropped from 300mm above the surface)
IK09	protected against 10 joules impact (equivalent to 5.0kg mass dropped from 200mm above the surface)
IK10	protected against 20 joules impact (equivalent to 5.0kg mass dropped from 400mm above the surface)