

PROJECT	_____
TYPE	_____
SPECIFIER	_____
QUANTITY	_____
DATE	_____

## TAO MONOPOINT SUSPENSION

### D141111-

base number                      Finish                       
Options                     

- To build a product code in our configurator select the specify button on the base model # product page
- To build a manual product code on this datasheet choose from the options listed below in blue font and add the suffix to the base model #

#### GENERAL

Series: Tao                       
 Subseries: Tao Monopoint                       
 Partner: Cangini & Tucci                       
 Division: Design                       
 Installation: Suspension                       
 Product Type: Pendant                       
 Mounting Location: Ceiling                     

#### PHYSICAL

Shape: Cylinder                       
 Diameter (mm): 80                       
 Diameter (in): 3 1/8                       
 Height (mm): 300                       
 Height (in): 11 13/16                       
 Max. Overall Height (mm): 1800                       
 Max. Overall Height (in): 70 7/8                       
 Weight (kg): 0.80                       
 Weight (lbs): 1.76                       
 Fixture Finish: AMB / GRN / PNK / RUB / SMK / TOB / TRA / RGD / TIM  
 Holder Finish: CHR                       
 Fixture Material: Glass / Metal                       
 Primary Material: Glass - Borosilicate                       
 Cable Details: 1500mm Cable                     

#### ELECTRICAL

Number of Lamps: 1                       
 Lamp Type: LED Retrofit                       
 Bulb Included: Bulb Not Included                       
 Max. Wattage Per Lamp (W): 3                       
 Lamp Base: G9                       
 Input Voltage (V): 120                       
 Upon Request: GU24 / 277Vac                     

#### LED

#### OPTICAL

#### RATINGS AND CERTIFICATIONS

Certified By: Certified for North American Standards                       
 IP rating: IP20                     

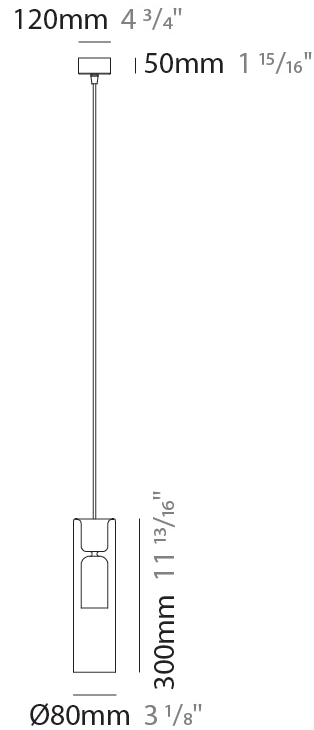

## TAO MONOPOINT SUSPENSION

D141111-

PROJECT

TYPE

SPECIFIER

QUANTITY

DATE



D

PROJECT
TYPE
SPECIFIER
QUANTITY
DATE

## TAO MONOPOINT SUSPENSION

### D141112-

base number Finish  
Options

- To build a product code in our configurator select the specify button on the base model # product page
- To build a manual product code on this datasheet choose from the options listed below in blue font and add the suffix to the base model #

#### GENERAL

Series: Tao  
 Subseries: Tao Monopoint  
 Partner: Cangini & Tucci  
 Division: Design  
 Installation: Suspension  
 Product Type: Pendant  
 Mounting Location: Ceiling

#### PHYSICAL

Shape: Cylinder  
 Diameter (mm): 100  
 Diameter (in): 3 <sup>15</sup>/<sub>16</sub>  
 Height (mm): 370  
 Height (in): 14 <sup>9</sup>/<sub>16</sub>  
 Max. Overall Height (mm): 1870  
 Max. Overall Height (in): 73 <sup>5</sup>/<sub>8</sub>  
 Weight (kg): 1.5  
 Weight (lbs): 3.31  
 Fixture Finish: [AMB](#) / [GRN](#) / [PNK](#) / [RUB](#) / [SMK](#) / [TOB](#) / [TRA](#) / [RGD](#) / [TIM](#)  
 Holder Finish: CHR  
 Fixture Material: Glass / Metal  
 Primary Material: Glass - Borosilicate  
 Cable Details: 1500mm Cable

#### ELECTRICAL

Number of Lamps: 1  
 Lamp Type: LED Retrofit  
 Bulb Included: Bulb Not Included  
 Max. Wattage Per Lamp (W): 8  
 Lamp Base: E26  
 Input Voltage (V): 120  
 Upon Request: GU24 / 277Vac

#### LED

#### OPTICAL

#### RATINGS AND CERTIFICATIONS

Certified By: Certified for North American Standards  
 IP rating: IP20

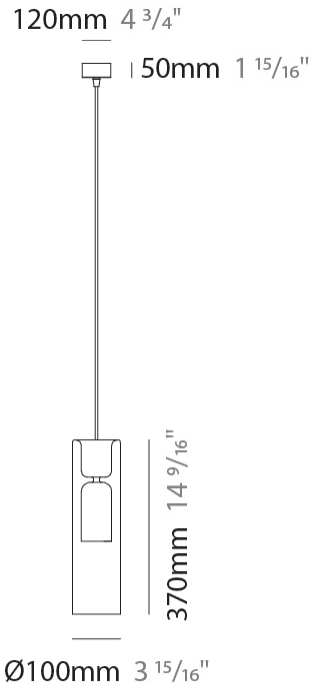

## TAO MONOPOINT SUSPENSION

D141112-

PROJECT

TYPE

SPECIFIER

QUANTITY

DATE

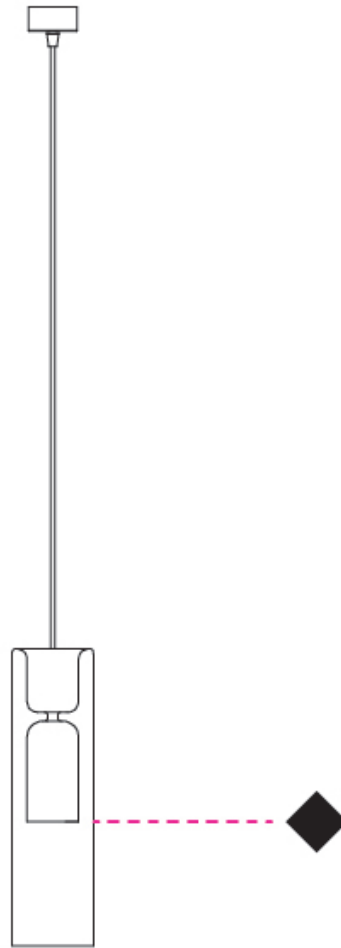

D

## TAO 2 LIGHT SWAG SUSPENSION

### D141115-

base number \_\_\_\_\_  
 Finish \_\_\_\_\_  
 Options \_\_\_\_\_

- To build a product code in our configurator select the specify button on the base model # product page
- To build a manual product code on this datasheet choose from the options listed below in blue font and add the suffix to the base model #

#### GENERAL

Series: Tao \_\_\_\_\_  
 Subseries: Tao 2 Light Swag \_\_\_\_\_  
 Partner: Cangiini & Tucci \_\_\_\_\_  
 Division: Design \_\_\_\_\_  
 Installation: Suspension \_\_\_\_\_  
 Product Type: Pendant \_\_\_\_\_  
 Mounting Location: Ceiling \_\_\_\_\_

#### PHYSICAL

Shape: Cylinder \_\_\_\_\_  
 Diameter (mm): 80 \_\_\_\_\_  
 Diameter (in): 3 1/8 \_\_\_\_\_  
 Height (mm): 300 \_\_\_\_\_  
 Height (in): 11 13/16 \_\_\_\_\_  
 Max. Overall Height (mm): 2300 \_\_\_\_\_  
 Max. Overall Height (in): 90 9/16 \_\_\_\_\_  
 Weight (kg): 1.5 \_\_\_\_\_  
 Weight (lbs): 3.31 \_\_\_\_\_  
 Fixture Finish: [AMB](#) / [GRN](#) / [PNK](#) / [RUB](#) / [SMK](#) / [TOB](#) / [TRA](#) / [RGD](#) / [TIM](#) \_\_\_\_\_  
 Holder Finish: CHR \_\_\_\_\_  
 Fixture Material: Glass / Metal \_\_\_\_\_  
 Primary Material: Glass - Borosilicate \_\_\_\_\_  
 Cable Details: 2000mm Cable \_\_\_\_\_

#### ELECTRICAL

Number of Lamps: 2 \_\_\_\_\_  
 Lamp Type: LED Retrofit \_\_\_\_\_  
 Bulb Included: Bulb Not Included \_\_\_\_\_  
 Total Output Wattage (W): 6 \_\_\_\_\_  
 Max. Wattage Per Lamp (W): 3 \_\_\_\_\_  
 Lamp Base: G9 \_\_\_\_\_  
 Input Voltage (V): 120 \_\_\_\_\_

#### LED

#### OPTICAL

#### RATINGS AND CERTIFICATIONS

Certified By: Certified for North American Standards \_\_\_\_\_  
 IP rating: IP20 \_\_\_\_\_

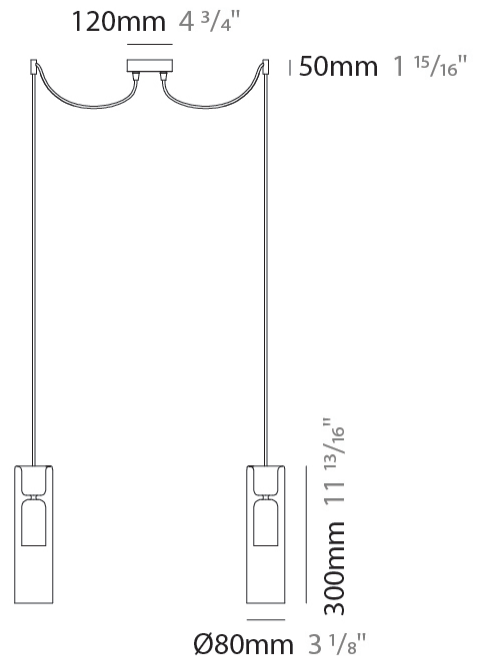

## TAO 2 LIGHT SWAG SUSPENSION

D141115-

PROJECT

TYPE

SPECIFIER

QUANTITY

DATE

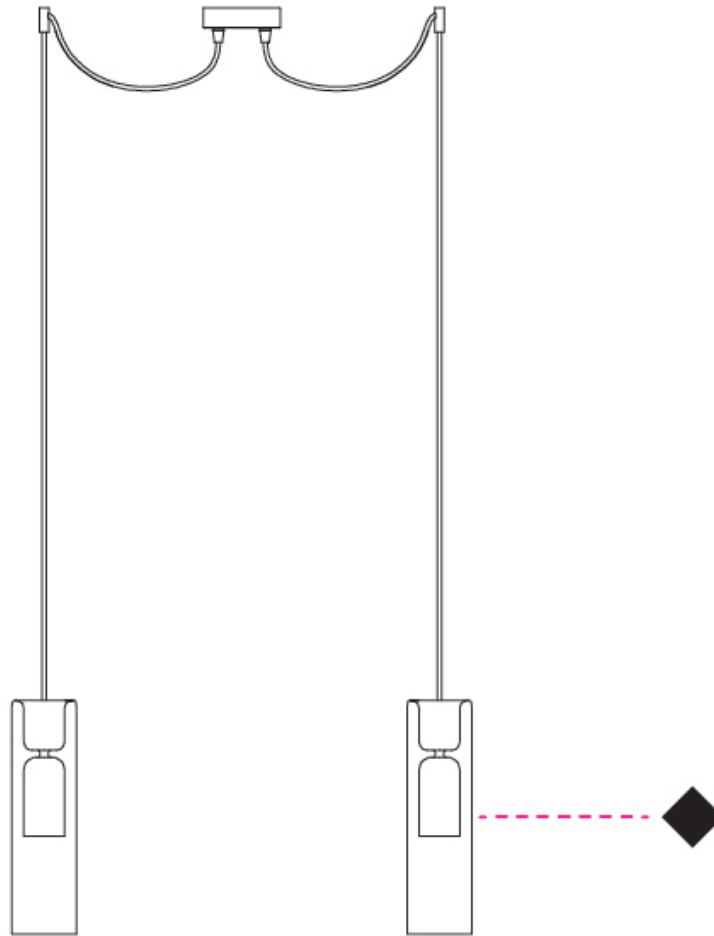

D

PROJECT	_____
TYPE	_____
SPECIFIER	_____
QUANTITY	_____
DATE	_____

## TAO 2 LIGHT SWAG SUSPENSION

### D141116-

base number                      Finish                       
Options                     

- To build a product code in our configurator select the specify button on the base model # product page
- To build a manual product code on this datasheet choose from the options listed below in blue font and add the suffix to the base model #

#### GENERAL

Series: Tao                       
 Subseries: Tao 2 Light Swag                       
 Partner: Cangani & Tucci                       
 Division: Design                       
 Installation: Suspension                       
 Product Type: Pendant                       
 Mounting Location: Ceiling                     

#### PHYSICAL

Shape: Cylinder                       
 Diameter (mm): 100                       
 Diameter (in): 3 <sup>15</sup>/<sub>16</sub>                       
 Height (mm): 370                       
 Height (in): 14 <sup>9</sup>/<sub>16</sub>                       
 Max. Overall Height (mm): 1870                       
 Max. Overall Height (in): 73 <sup>5</sup>/<sub>8</sub>                       
 Weight (kg): 3.2                       
 Weight (lbs): 7.05                       
 Fixture Finish: [AMB](#) / [GRN](#) / [PNK](#) / [RUB](#) / [SMK](#) / [TOB](#) / [TRA](#) / [RGD](#) / [TIM](#)                       
 Holder Finish: CHR                       
 Fixture Material: Glass / Metal                       
 Primary Material: Glass - Borosilicate                       
 Cable Details: 1500mm Cable                     

#### ELECTRICAL

Number of Lamps: 2                       
 Lamp Type: LED Retrofit                       
 Bulb Included: Bulb Not Included                       
 Total Output Wattage (W): 16                       
 Max. Wattage Per Lamp (W): 8                       
 Lamp Base: E26                       
 Input Voltage (V): 120                       
 Upon Request: GU24 / 277Vac                     

#### LED

#### OPTICAL

#### RATINGS AND CERTIFICATIONS

Certified By: Certified for North American Standards                       
 IP rating: IP20                     

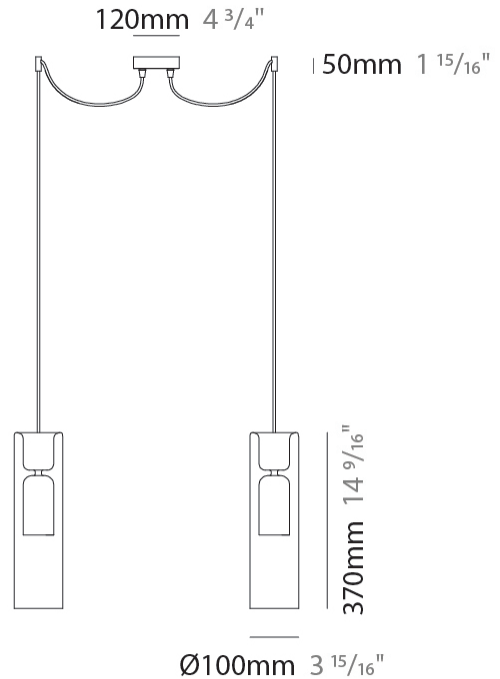

## TAO 2 LIGHT SWAG SUSPENSION

D141116-

PROJECT	_____
TYPE	_____
SPECIFIER	_____
QUANTITY	_____
DATE	_____

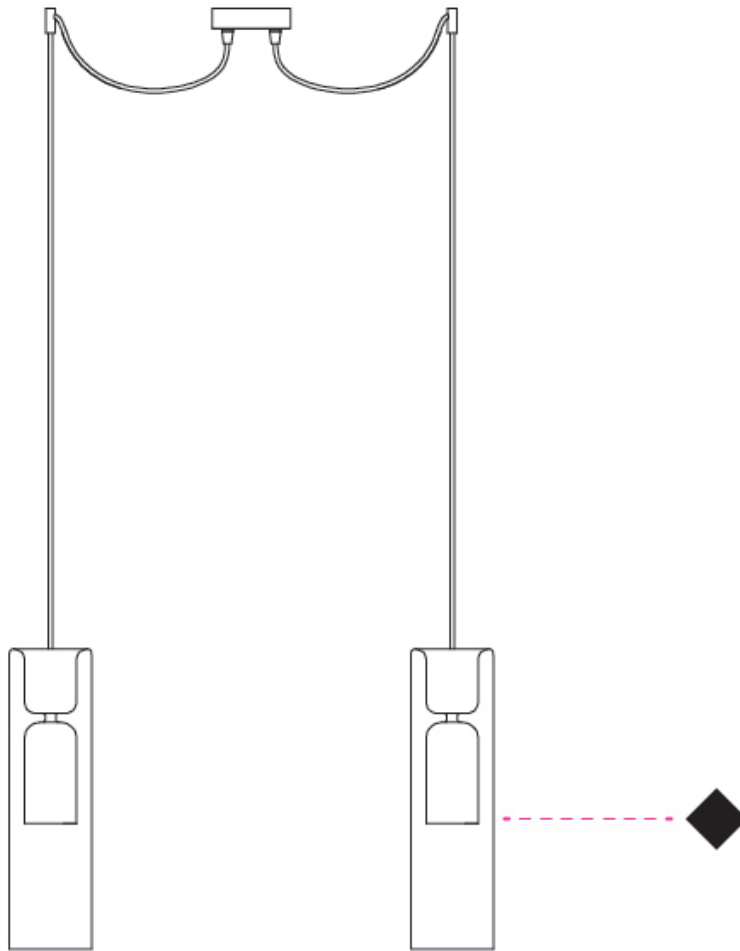

D

PROJECT
TYPE
SPECIFIER
QUANTITY
DATE

## TAO 6 LIGHT CLUSTER SUSPENSION

### D141117-

base number Finish  
Options

- To build a product code in our configurator select the specify button on the base model # product page
- To build a manual product code on this datasheet choose from the options listed below in blue font and add the suffix to the base model #

#### GENERAL

Series: Tao  
 Subseries: Tao 6 Light Cluster  
 Partner: Cangini & Tucci  
 Division: Design  
 Installation: Suspension  
 Product Type: Pendant  
 Mounting Location: Ceiling

#### PHYSICAL

Shape: Cylinder  
 Diameter (mm): 270  
 Diameter (in): 10 <sup>5</sup>/<sub>8</sub>  
 Max. Overall Height (mm): 1500  
 Max. Overall Height (in): 59 <sup>1</sup>/<sub>16</sub>  
 Weight (kg): 5.25  
 Weight (lbs): 11.5  
 Fixture Finish: [AMB](#) / [GRN](#) / [PNK](#) / [RUB](#) / [SMK](#) / [TOB](#) / [TRA](#) / [RGD](#) / [TIM](#)  
 Holder Finish: PSS  
 Fixture Material: Glass / Metal  
 Primary Material: Glass - Borosilicate  
 Cable Details: 1500mm Cable

#### ELECTRICAL

Number of Lamps: 6  
 Lamp Type: LED Retrofit  
 Bulb Included: Bulb Not Included  
 Total Output Wattage (W): 18  
 Max. Wattage Per Lamp (W): 3  
 Lamp Base: G9  
 Input Voltage (V): 120

#### LED

#### OPTICAL

#### RATINGS AND CERTIFICATIONS

Certified By: Certified for North American Standards  
 IP rating: IP20



270mm 10 <sup>5</sup>/<sub>8</sub>"

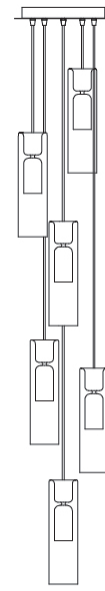

300mm 11 <sup>13</sup>/<sub>16</sub>"

Ø80mm 3 <sup>1</sup>/<sub>8</sub>"



## TAO 6 LIGHT CLUSTER SUSPENSION

D141117-

PROJECT

TYPE

SPECIFIER

QUANTITY

DATE

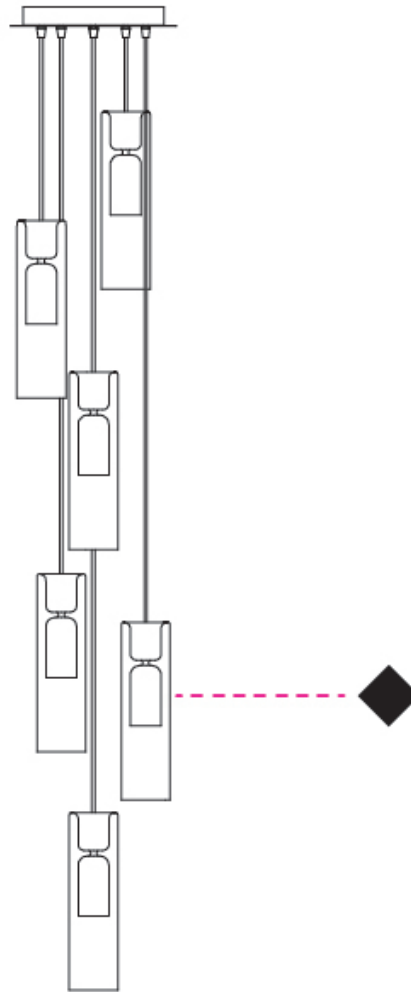

D

PROJECT
TYPE
SPECIFIER
QUANTITY
DATE

## TAO 3 LIGHT CLUSTER SUSPENSION

### D141118-

base number Finish  
Options

- To build a product code in our configurator select the specify button on the base model # product page
- To build a manual product code on this datasheet choose from the options listed below in blue font and add the suffix to the base model #

#### GENERAL

Series: Tao  
 Subseries: Tao 3 Light Cluster  
 Partner: Cangani & Tucci  
 Division: Design  
 Installation: Suspension  
 Product Type: Pendant  
 Mounting Location: Ceiling

#### PHYSICAL

Shape: Cylinder  
 Diameter (mm): 270  
 Diameter (in): 10 <sup>5</sup>/<sub>8</sub>  
 Height (mm): 1500  
 Height (in): 59 <sup>1</sup>/<sub>16</sub>  
 Weight (kg): 5.60  
 Weight (lbs): 12.34  
 Fixture Finish: [AMB](#) / [GRN](#) / [PNK](#) / [RUB](#) / [SMK](#) / [TOB](#) / [TRA](#) / [RGD](#) / [TIM](#)  
 Holder Finish: PSS  
 Fixture Material: Glass / Metal  
 Primary Material: Glass - Borosilicate  
 Cable Details: 1500mm Cable

#### ELECTRICAL

Number of Lamps: 3  
 Lamp Type: LED Retrofit  
 Bulb Included: Bulb Not Included  
 Total Output Wattage (W): 24  
 Max. Wattage Per Lamp (W): 8  
 Lamp Base: G9  
 Input Voltage (V): 120

#### LED

#### OPTICAL

#### RATINGS AND CERTIFICATIONS

Certified By: Certified for North American Standards  
 IP rating: IP20



270mm 10 <sup>5</sup>/<sub>8</sub>"

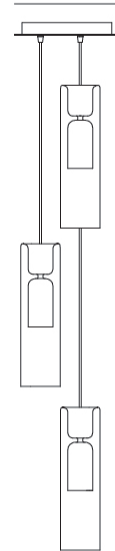

370mm 14 <sup>9</sup>/<sub>16</sub>"

Ø100mm 3 <sup>15</sup>/<sub>16</sub>"



## TAO 3 LIGHT CLUSTER SUSPENSION

D141118-

PROJECT \_\_\_\_\_

TYPE \_\_\_\_\_

SPECIFIER \_\_\_\_\_

QUANTITY \_\_\_\_\_

DATE \_\_\_\_\_

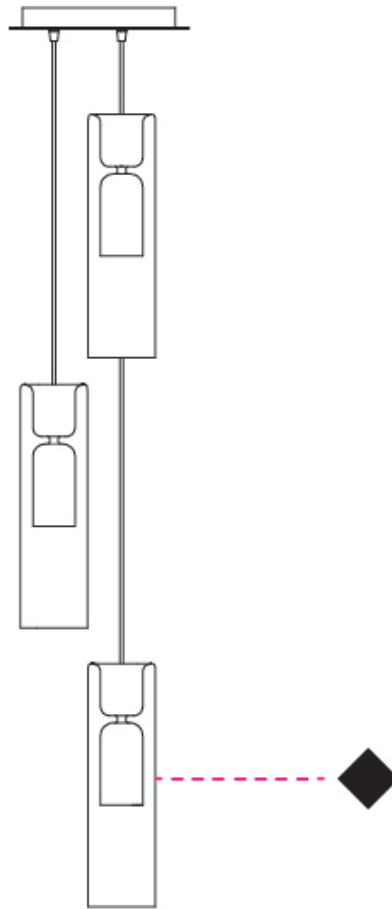

D

PROJECT	
TYPE	
SPECIFIER	
QUANTITY	
DATE	

## TAO 3 LIGHT LINEAR SUSPENSION

### D141120-

base number Finish  
Options

- To build a product code in our configurator select the specify button on the base model # product page
- To build a manual product code on this datasheet choose from the options listed below in blue font and add the suffix to the base model #

#### GENERAL

Series: Tao  
 Subseries: Tao 3 Light Linear  
 Partner: Cangini & Tucci  
 Division: Design  
 Installation: Suspension  
 Product Type: Pendant  
 Mounting Location: Ceiling

#### PHYSICAL

Shape: Cylinder  
 Length (mm): 700  
 Length (in): 27 <sup>9</sup>/<sub>16</sub>"  
 Height (mm): 1500  
 Height (in): 59 <sup>1</sup>/<sub>16</sub>"  
 Weight (kg): 6.90  
 Weight (lbs): 15.21  
 Fixture Finish: [AMB](#) / [GRN](#) / [PNK](#) / [RUB](#) / [SMK](#) / [TOB](#) / [TRA](#) / [RGD](#) / [TIM](#)  
 Holder Finish: PSS  
 Fixture Material: Glass / Metal  
 Primary Material: Glass - Borosilicate  
 Cable Details: 1500mm Cable

#### ELECTRICAL

Number of Lamps: 3  
 Lamp Type: LED Retrofit  
 Bulb Included: Bulb Not Included  
 Total Output Wattage (W): 24  
 Max. Wattage Per Lamp (W): 8  
 Lamp Base: G9  
 Input Voltage (V): 120

#### LED

#### OPTICAL

#### RATINGS AND CERTIFICATIONS

Certified By: Certified for North American Standards  
 IP rating: IP20

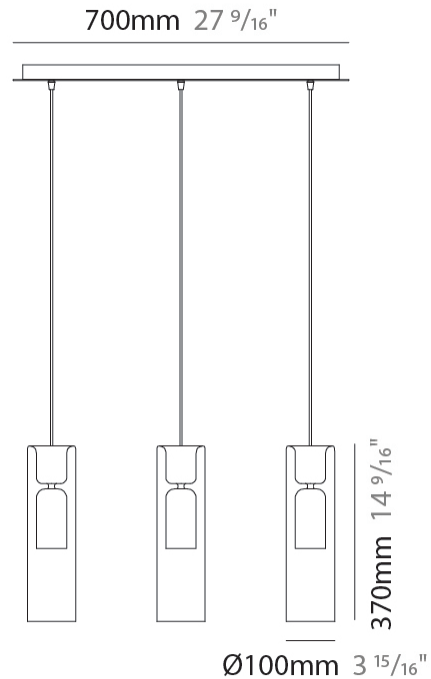

## TAO 3 LIGHT LINEAR SUSPENSION

D141120-

PROJECT	_____
TYPE	_____
SPECIFIER	_____
QUANTITY	_____
DATE	_____

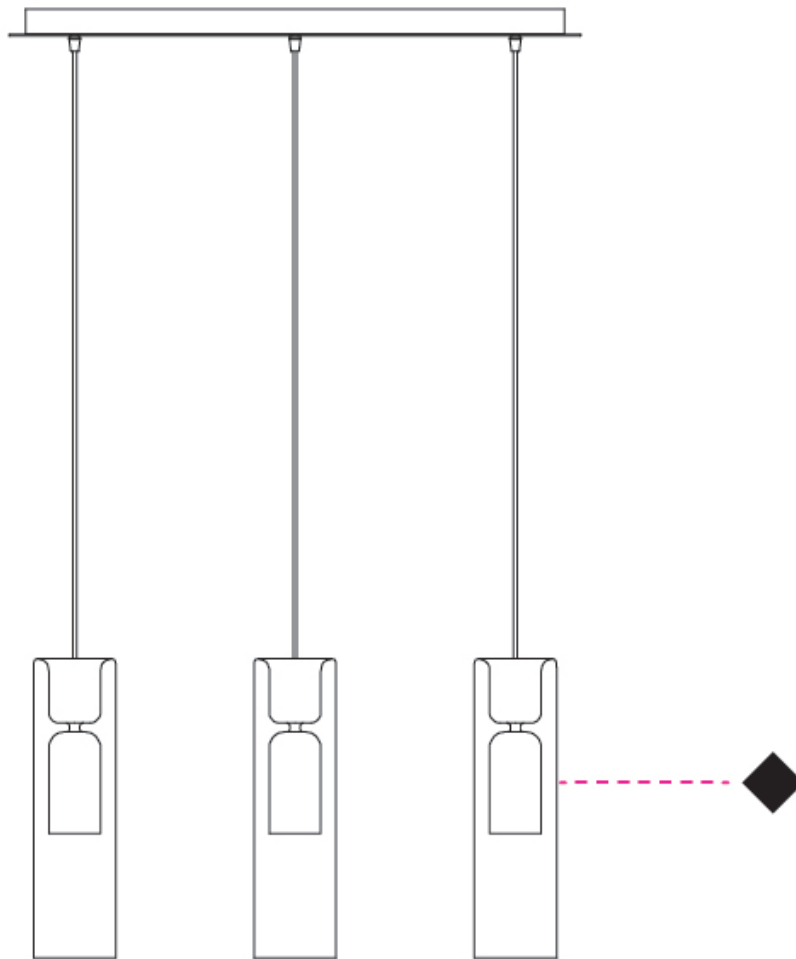

D

PROJECT
TYPE
SPECIFIER
QUANTITY
DATE

## TAO SURFACE

### D143018-

base number Finish  
Options

- To build a product code in our configurator select the specify button on the base model # product page
- To build a manual product code on this datasheet choose from the options listed below in blue font and add the suffix to the base model #

#### GENERAL

Series: Tao  
 Partner: Cangini & Tucci  
 Division: Design  
 Installation: Surface  
 Product Type: Wall Surface  
 Mounting Location: Wall

#### PHYSICAL

Shape: Cylinder  
 Diameter (mm): 80  
 Diameter (in): 3 1/8  
 Height (mm): 330  
 Depth (mm): 160  
 Height (in): 13  
 Depth (in): 6 5/16  
 Extension (mm): 160  
 Extension (in): 6 5/16  
 Weight (kg): 1.075  
 Weight (lbs): 2.37  
 Fixture Finish: AMB / GRN / PNK / RUB / SMK / TOB / TRA / RGD / TIM  
 Holder Finish: CHR  
 Fixture Material: Glass / Metal  
 Primary Material: Glass - Borosilicate

#### ELECTRICAL

Number of Lamps: 1  
 Lamp Type: LED Retrofit  
 Bulb Included: Bulb Not Included  
 Max. Wattage Per Lamp (W): 3  
 Lamp Base: G9  
 Input Voltage (V): 120

#### LED

#### OPTICAL

#### RATINGS AND CERTIFICATIONS

Certified By: Certified for North American Standards  
 IP rating: IP20

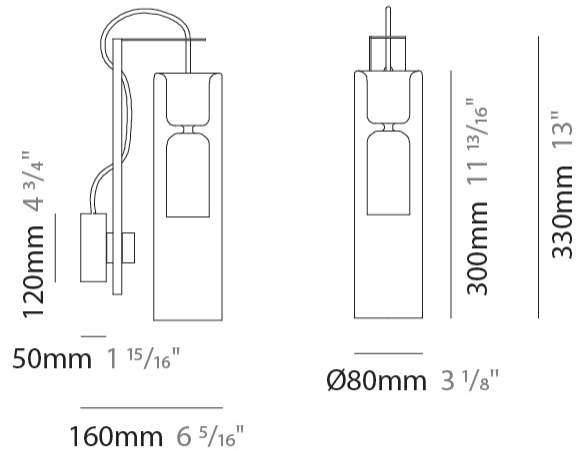

## TAO SURFACE

D143018-

PROJECT	_____
TYPE	_____
SPECIFIER	_____
QUANTITY	_____
DATE	_____

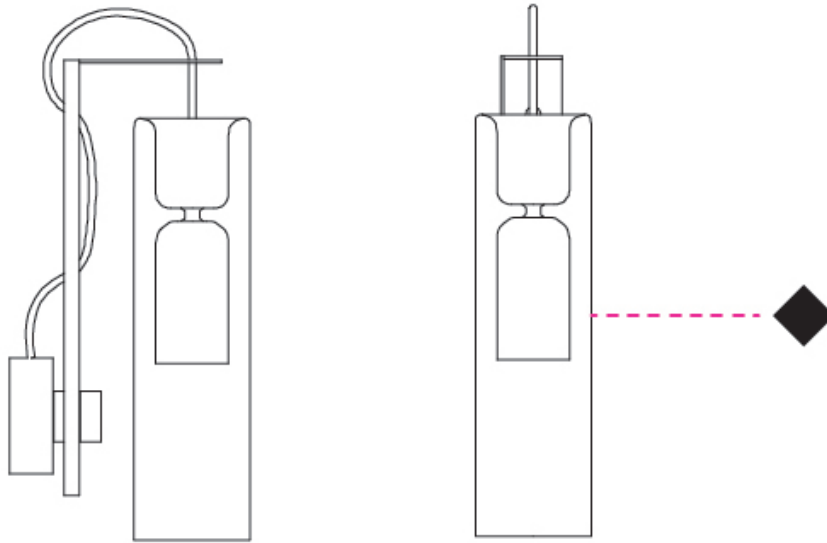

D

## TAO COLOR FINISH CHART

PROJECT	_____
TYPE	_____
SPECIFIER	_____
QUANTITY	_____
DATE	_____

### Fixture Finish

Amber - AMB



Green - GRN



Pink - PNK



Ruby - RUB



Smoke - SMK



Tobacco - TOB



Transparent - TRA



Rose Gold - RGD

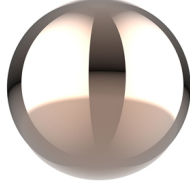

Titanium - TIM

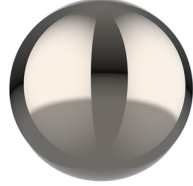

### Holder Finish

Chrome - CHR



Polished Stainless Steel - PSS



**Digital:** Not all screens are calibrated the same, and therefore, colors will appear differently between screens.











**Physical:** When texture is involved, there will be variations in color, character and tone within a product series and between product families.













### LEGEND

	floor-mounted		pivotal		special LED (upon request) RGB, RGBW, tunable, gold+, meat+, art+, fashion+
	wall and ceiling: recessed and surface mounted		rotating		warm dim / natural dimming LED
	ceiling-mounted and wall-mounted		illuminate tilted		rechargeable battery powered
	wall-mounted		color of suspension cable		fixture with natural vivid LED (upon request)
	omni-directional light distribution		length of suspension cable		color rendering index
	direct light distribution		reflector degree selection		color temperature
	direct/indirect light distribution		super spot		lumen (luminous flux)
	indirect light distribution		lens		efficacy (lumens per watt)
	asymmetric light distribution		lens pack		Unified Glare Rating (UGR) range from 5-40
	aura light distribution		shine ring		marine grade (AISI 316 stainless steel)
	round wall or ceiling cut-out		integrated shine ring with diffuser		walk on
	square wall or ceiling cut-out		free individual colors 01-29		drive on
	the supplied jig specifies the cutout dimensions		individual colors: 00 (free of charge), 01-25 (extra charge)		Dark Sky Compliance
	minimum distance (meters) lamp - object		luminaire part to be colored (F1)		Americans with Disabilities Act (less than 4" off the wall located between 27"-84" from floor)
	recessed depth		luminaire part to be colored (F2)		lamp protected against explosion
	ceiling thickness in mm		luminaire part to be colored (F3)		blown glass using traditional methods by master glass blower
	ceiling thickness selection		luminaire part to be colored (F4)		acoustic material
	dimmable DP (phase), DV (0-10V), DD (dali), DS (step-dim)		luminaire part to be colored (F5)		protection class I, protection insulation
	included or excluded LED driver/transformer/control gear		color of 3-circuit adaptor		protection class II, protection insulation
	separately switchable		indirect diffuser		ETL Certified to UL and CSA Standards
	sensor		direct diffuser		UL Certified to UL and CSA Standards
	remote control		ball-proof (upon request)		CSA Certified to UL and CSA Standards
	available upon request		accessory		Certified for North American Standards

### IP RATING

	protected against ingress of solid bodies greater than 12.5mm (finger)
	protected against ingress of solid bodies greater than 2.5mm protected against sprays of water up to 60 degrees from the vertical (rain)
	protected against ingress of solid bodies greater than 1mm (wire) no protection against the ingress of moisture
	protected against ingress of solid bodies greater than 1mm (wire) protected against sprays of water up to 60 degrees from the vertical (rain)
	protected against ingress of solid bodies greater than 1mm (wire) protected against water splashed from all directions
	protected against limited ingress of dust (wet rooms/covered outdoor areas) protected against water splashed from all directions
	protected against ingress of dust protected against jets of water
	protected against ingress of dust protected against powerful jets of water or heavy seas
	protected against ingress of dust protected against immersion of water between 15cm - 1m for 30 minutes
	protected against ingress of dust protected against immersion of water under pressure for long periods

### IK RATING

	protected against 0.14 joules impact (equivalent to 0.25kg mass dropped from 56mm above the surface)
	protected against 0.2 joules impact (equivalent to 0.25kg mass dropped from 80mm above the surface)
	protected against 0.35 joules impact (equivalent to 0.25kg mass dropped from 140mm above the surface)
	protected against 0.5 joules impact (equivalent to 0.25kg mass dropped from 200mm above the surface)
	protected against 0.7 joules impact (equivalent to 0.25kg mass dropped from 280mm above the surface)
	protected against 1 joules impact (equivalent to 0.25kg mass dropped from 400mm above the surface)
	protected against 2 joules impact (equivalent to 0.5kg mass dropped from 400mm above the surface)
	protected against 5 joules impact (equivalent to 1.7kg mass dropped from 300mm above the surface)
	protected against 10 joules impact (equivalent to 5.0kg mass dropped from 200mm above the surface)
	protected against 20 joules impact (equivalent to 5.0kg mass dropped from 400mm above the surface)