

PROJECT	
TYPE	
SPECIFIER	
QUANTITY	
DATE	

TAO MONOPOINT SUSPENSION

D141111-

base number Finish
Options

- To build a product code in our configurator select the specify button on the base model # product page
- To build a manual product code on this datasheet choose from the options listed below in blue font and add the suffix to the base model #

GENERAL

Series: Tao
 Subseries: Tao Monopoint
 Partner: Cangini & Tucci
 Division: Design
 Installation: Suspension
 Product Type: Pendant
 Mounting Location: Ceiling

PHYSICAL

Shape: Cylinder
 Diameter (mm): 80
 Diameter (in): 3 1/8
 Height (mm): 300
 Height (in): 11 13/16
 Max. Overall Height (mm): 1800
 Max. Overall Height (in): 70 7/8
 Weight (kg): 0.80
 Weight (lbs): 1.76
 Fixture Finish: [AMB](#) / [GRN](#) / [PNK](#) / [RUB](#) / [SMK](#) / [TOB](#) / [TRA](#) / [RGD](#) / [TIM](#)
 Holder Finish: CHR
 Fixture Material: Glass / Metal
 Primary Material: Glass - Borosilicate
 Cable Details: 1500mm Cable

ELECTRICAL

Number of Lamps: 1
 Lamp Type: LED Retrofit
 Bulb Included: Bulb Not Included
 Max. Wattage Per Lamp (W): 3
 Lamp Base: G9
 Input Voltage (V): 120
 Upon Request: GU24 / 277Vac

LED

OPTICAL

RATINGS AND CERTIFICATIONS

Certified By: Certified for North American Standards
 IP rating: IP20

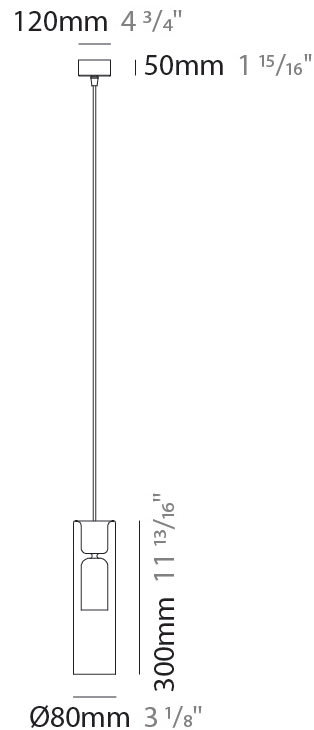

TAO MONOPOINT SUSPENSION

D141111-

PROJECT

TYPE

SPECIFIER

QUANTITY

DATE



D

PROJECT
TYPE
SPECIFIER
QUANTITY
DATE

TAO MONOPOINT SUSPENSION

D141112-

base number Finish
Options

- To build a product code in our configurator select the specify button on the base model # product page
- To build a manual product code on this datasheet choose from the options listed below in blue font and add the suffix to the base model #

GENERAL

Series: Tao
 Subseries: Tao Monopoint
 Partner: Cangini & Tucci
 Division: Design
 Installation: Suspension
 Product Type: Pendant
 Mounting Location: Ceiling

PHYSICAL

Shape: Cylinder
 Diameter (mm): 100
 Diameter (in): 3 ¹⁵/₁₆
 Height (mm): 370
 Height (in): 14 ⁹/₁₆
 Max. Overall Height (mm): 1870
 Max. Overall Height (in): 73 ⁵/₈
 Weight (kg): 1.5
 Weight (lbs): 3.31
 Fixture Finish: [AMB](#) / [GRN](#) / [PNK](#) / [RUB](#) / [SMK](#) / [TOB](#) / [TRA](#) / [RGD](#) / [TIM](#)
 Holder Finish: CHR
 Fixture Material: Glass / Metal
 Primary Material: Glass - Borosilicate
 Cable Details: 1500mm Cable

ELECTRICAL

Number of Lamps: 1
 Lamp Type: LED Retrofit
 Bulb Included: Bulb Not Included
 Max. Wattage Per Lamp (W): 8
 Lamp Base: E26
 Input Voltage (V): 120
 Upon Request: GU24 / 277Vac

LED

OPTICAL

RATINGS AND CERTIFICATIONS

Certified By: Certified for North American Standards
 IP rating: IP20

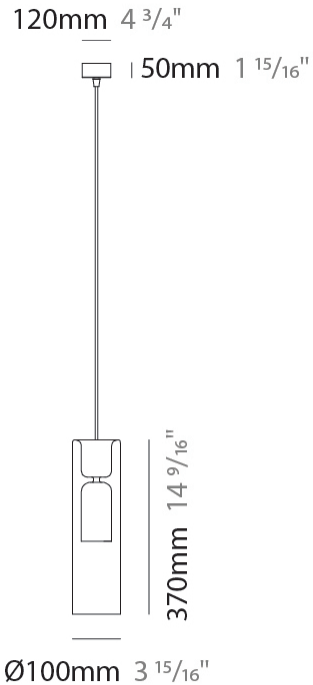

TAO MONOPOINT SUSPENSION

D141112-

PROJECT

TYPE

SPECIFIER

QUANTITY

DATE

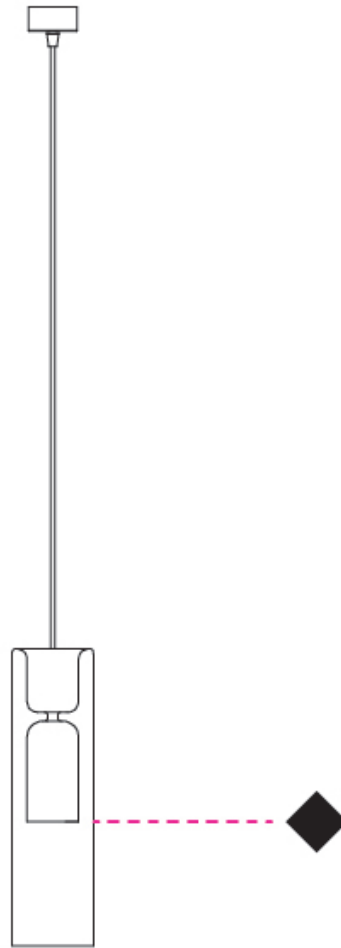

D

PROJECT	_____
TYPE	_____
SPECIFIER	_____
QUANTITY	_____
DATE	_____

TAO 2 LIGHT SWAG SUSPENSION

D141115-

base number Finish
Options

- To build a product code in our configurator select the specify button on the base model # product page
- To build a manual product code on this datasheet choose from the options listed below in blue font and add the suffix to the base model #

GENERAL

Series: Tao
 Subseries: Tao 2 Light Swag
 Partner: Cangiini & Tucci
 Division: Design
 Installation: Suspension
 Product Type: Pendant
 Mounting Location: Ceiling

PHYSICAL

Shape: Cylinder
 Diameter (mm): 80
 Diameter (in): 3 1/8
 Height (mm): 300
 Height (in): 11 13/16
 Max. Overall Height (mm): 2300
 Max. Overall Height (in): 90 9/16
 Weight (kg): 1.5
 Weight (lbs): 3.31
 Fixture Finish: AMB / GRN / PNK / RUB / SMK / TOB / TRA / RGD / TIM
 Holder Finish: CHR
 Fixture Material: Glass / Metal
 Primary Material: Glass - Borosilicate
 Cable Details: 2000mm Cable

ELECTRICAL

Number of Lamps: 2
 Lamp Type: LED Retrofit
 Bulb Included: Bulb Not Included
 Total Output Wattage (W): 6
 Max. Wattage Per Lamp (W): 3
 Lamp Base: G9
 Input Voltage (V): 120

LED

OPTICAL

RATINGS AND CERTIFICATIONS

Certified By: Certified for North American Standards
 IP rating: IP20

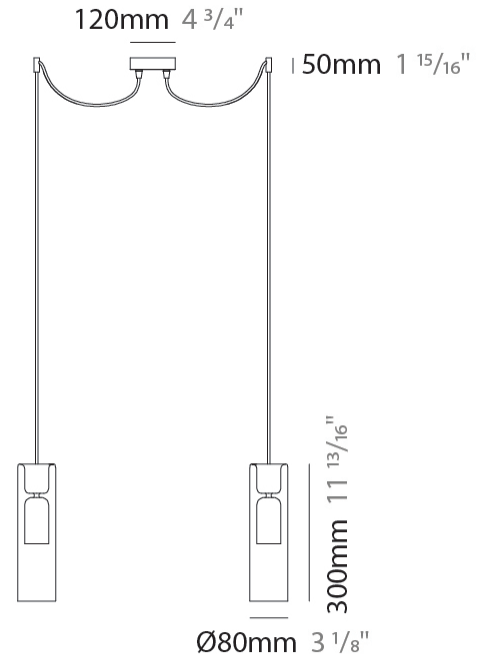

TAO 2 LIGHT SWAG SUSPENSION

D141115-

PROJECT

TYPE

SPECIFIER

QUANTITY

DATE

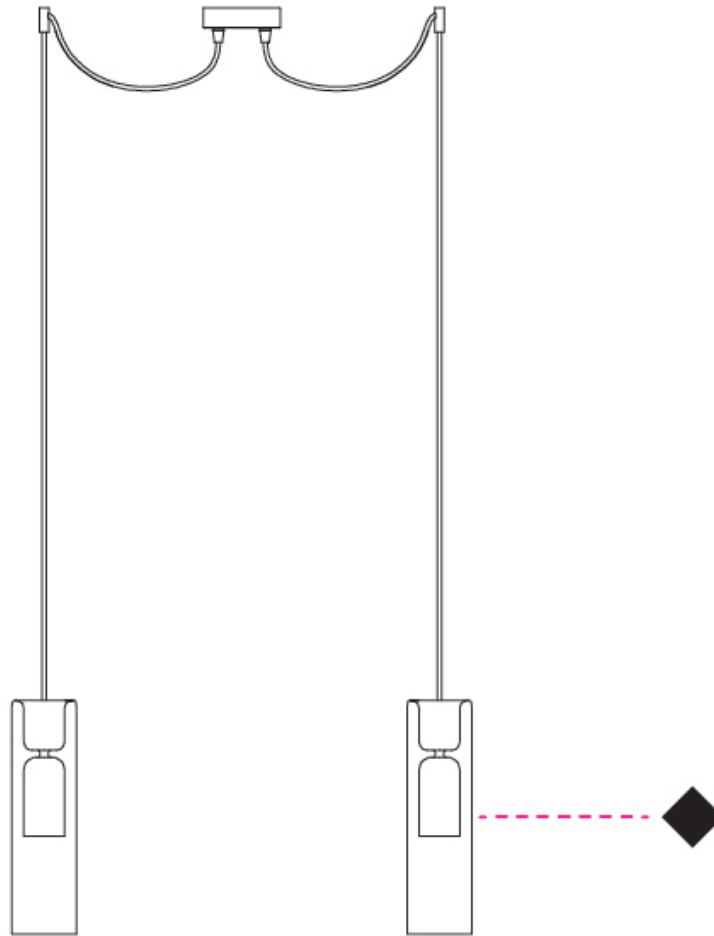

D

PROJECT	_____
TYPE	_____
SPECIFIER	_____
QUANTITY	_____
DATE	_____

TAO 2 LIGHT SWAG SUSPENSION

D141116-

base number Finish
Options

- To build a product code in our configurator select the specify button on the base model # product page
- To build a manual product code on this datasheet choose from the options listed below in blue font and add the suffix to the base model #

GENERAL

Series: Tao
 Subseries: Tao 2 Light Swag
 Partner: Cangani & Tucci
 Division: Design
 Installation: Suspension
 Product Type: Pendant
 Mounting Location: Ceiling

PHYSICAL

Shape: Cylinder
 Diameter (mm): 100
 Diameter (in): 3 ¹⁵/₁₆
 Height (mm): 370
 Height (in): 14 ⁹/₁₆
 Max. Overall Height (mm): 1870
 Max. Overall Height (in): 73 ⁵/₈
 Weight (kg): 3.2
 Weight (lbs): 7.05
 Fixture Finish: [AMB](#) / [GRN](#) / [PNK](#) / [RUB](#) / [SMK](#) / [TOB](#) / [TRA](#) / [RGD](#) / [TIM](#)
 Holder Finish: CHR
 Fixture Material: Glass / Metal
 Primary Material: Glass - Borosilicate
 Cable Details: 1500mm Cable

ELECTRICAL

Number of Lamps: 2
 Lamp Type: LED Retrofit
 Bulb Included: Bulb Not Included
 Total Output Wattage (W): 16
 Max. Wattage Per Lamp (W): 8
 Lamp Base: E26
 Input Voltage (V): 120
 Upon Request: GU24 / 277Vac

LED

OPTICAL

RATINGS AND CERTIFICATIONS

Certified By: Certified for North American Standards
 IP rating: IP20

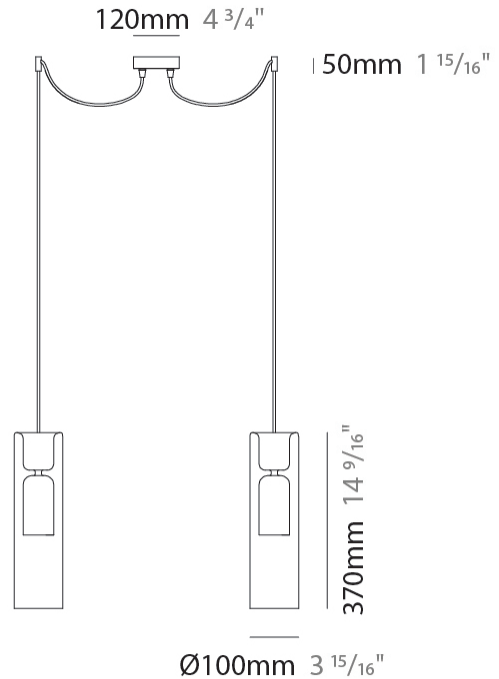

TAO 2 LIGHT SWAG SUSPENSION

D141116-

PROJECT _____

TYPE _____

SPECIFIER _____

QUANTITY _____

DATE _____

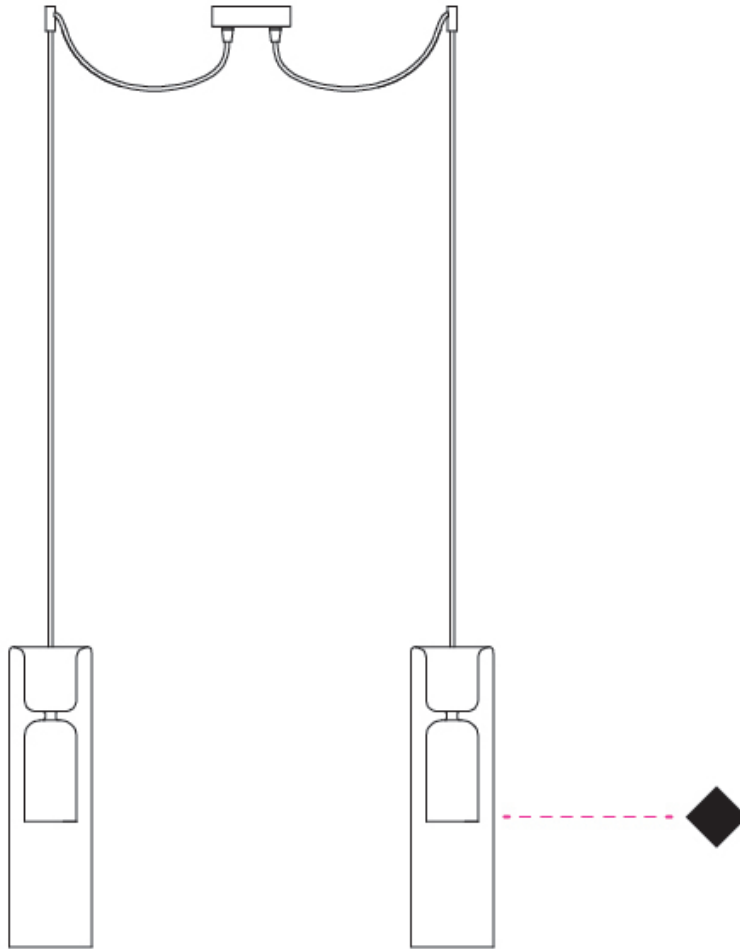

D

PROJECT
TYPE
SPECIFIER
QUANTITY
DATE

TAO 6 LIGHT CLUSTER SUSPENSION

D141117-

base number Finish
Options

- To build a product code in our configurator select the specify button on the base model # product page
- To build a manual product code on this datasheet choose from the options listed below in blue font and add the suffix to the base model #

GENERAL

Series: Tao
 Subseries: Tao 6 Light Cluster
 Partner: Cangini & Tucci
 Division: Design
 Installation: Suspension
 Product Type: Pendant
 Mounting Location: Ceiling

PHYSICAL

Shape: Cylinder
 Diameter (mm): 270
 Diameter (in): 10 ⁵/₈
 Max. Overall Height (mm): 1500
 Max. Overall Height (in): 59 ¹/₁₆
 Weight (kg): 5.25
 Weight (lbs): 11.5
 Fixture Finish: [AMB](#) / [GRN](#) / [PNK](#) / [RUB](#) / [SMK](#) / [TOB](#) / [TRA](#) / [RGD](#) / [TIM](#)
 Holder Finish: PSS
 Fixture Material: Glass / Metal
 Primary Material: Glass - Borosilicate
 Cable Details: 1500mm Cable

ELECTRICAL

Number of Lamps: 6
 Lamp Type: LED Retrofit
 Bulb Included: Bulb Not Included
 Total Output Wattage (W): 18
 Max. Wattage Per Lamp (W): 3
 Lamp Base: G9
 Input Voltage (V): 120

LED

OPTICAL

RATINGS AND CERTIFICATIONS

Certified By: Certified for North American Standards
 IP rating: IP20



270mm 10 ⁵/₈"

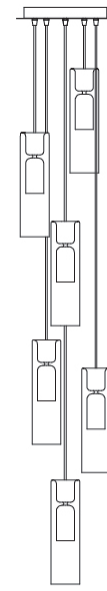

300mm 11 ¹³/₁₆"

Ø80mm 3 ¹/₈"



TAO 6 LIGHT CLUSTER SUSPENSION

D141117-

PROJECT

TYPE

SPECIFIER

QUANTITY

DATE

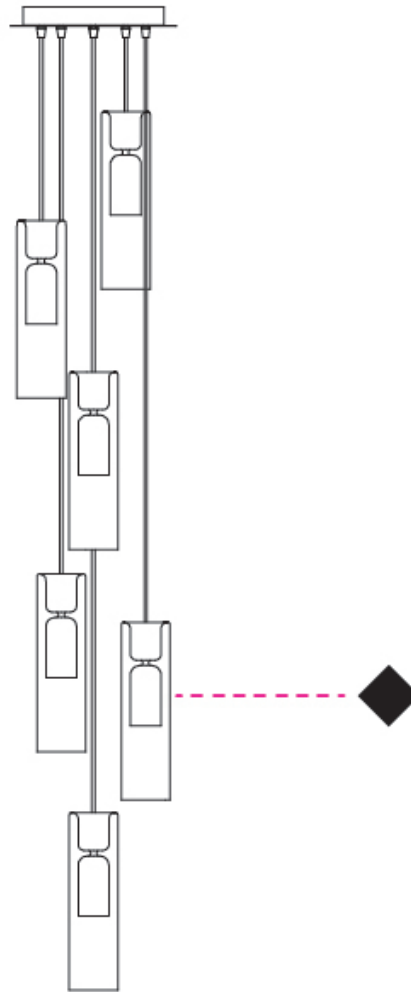

D

PROJECT
TYPE
SPECIFIER
QUANTITY
DATE

TAO 3 LIGHT CLUSTER SUSPENSION

D141118-

base number Finish
Options

- To build a product code in our configurator select the specify button on the base model # product page
- To build a manual product code on this datasheet choose from the options listed below in blue font and add the suffix to the base model #

GENERAL

Series: Tao
 Subseries: Tao 3 Light Cluster
 Partner: Cangani & Tucci
 Division: Design
 Installation: Suspension
 Product Type: Pendant
 Mounting Location: Ceiling

PHYSICAL

Shape: Cylinder
 Diameter (mm): 270
 Diameter (in): 10 ⁵/₈
 Height (mm): 1500
 Height (in): 59 ¹/₁₆
 Weight (kg): 5.60
 Weight (lbs): 12.34
 Fixture Finish: [AMB](#) / [GRN](#) / [PNK](#) / [RUB](#) / [SMK](#) / [TOB](#) / [TRA](#) / [RGD](#) / [TIM](#)
 Holder Finish: PSS
 Fixture Material: Glass / Metal
 Primary Material: Glass - Borosilicate
 Cable Details: 1500mm Cable

ELECTRICAL

Number of Lamps: 3
 Lamp Type: LED Retrofit
 Bulb Included: Bulb Not Included
 Total Output Wattage (W): 24
 Max. Wattage Per Lamp (W): 8
 Lamp Base: G9
 Input Voltage (V): 120

LED

OPTICAL

RATINGS AND CERTIFICATIONS

Certified By: Certified for North American Standards
 IP rating: IP20



270mm 10 ⁵/₈"

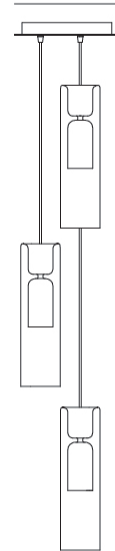

370mm 14 ⁹/₁₆"

Ø100mm 3 ¹⁵/₁₆"



TAO 3 LIGHT CLUSTER SUSPENSION

D141118-

PROJECT

TYPE

SPECIFIER

QUANTITY

DATE

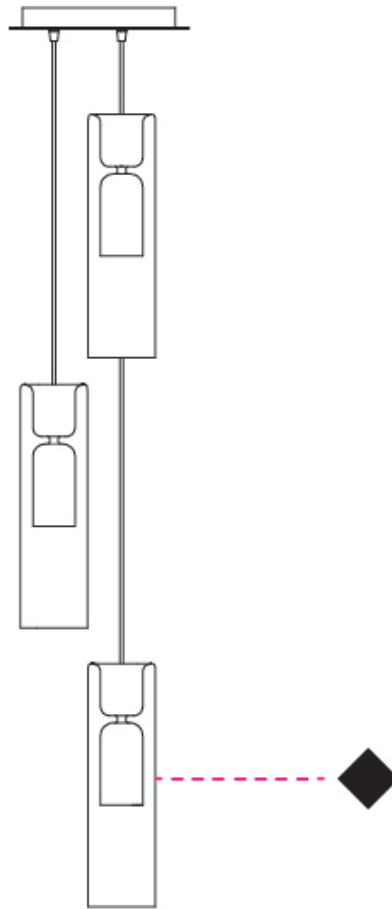

D

PROJECT
TYPE
SPECIFIER
QUANTITY
DATE

TAO 3 LIGHT LINEAR SUSPENSION

D141120-

base number Finish
Options

- To build a product code in our configurator select the specify button on the base model # product page
- To build a manual product code on this datasheet choose from the options listed below in blue font and add the suffix to the base model #

GENERAL

Series: Tao
 Subseries: Tao 3 Light Linear
 Partner: Cangini & Tucci
 Division: Design
 Installation: Suspension
 Product Type: Pendant
 Mounting Location: Ceiling

PHYSICAL

Shape: Cylinder
 Length (mm): 700
 Length (in): 27 ⁹/₁₆"
 Height (mm): 1500
 Height (in): 59 ¹/₁₆"
 Weight (kg): 6.90
 Weight (lbs): 15.21
 Fixture Finish: [AMB](#) / [GRN](#) / [PNK](#) / [RUB](#) / [SMK](#) / [TOB](#) / [TRA](#) / [RGD](#) / [TIM](#)
 Holder Finish: PSS
 Fixture Material: Glass / Metal
 Primary Material: Glass - Borosilicate
 Cable Details: 1500mm Cable

ELECTRICAL

Number of Lamps: 3
 Lamp Type: LED Retrofit
 Bulb Included: Bulb Not Included
 Total Output Wattage (W): 24
 Max. Wattage Per Lamp (W): 8
 Lamp Base: G9
 Input Voltage (V): 120

LED

OPTICAL

RATINGS AND CERTIFICATIONS

Certified By: Certified for North American Standards
 IP rating: IP20

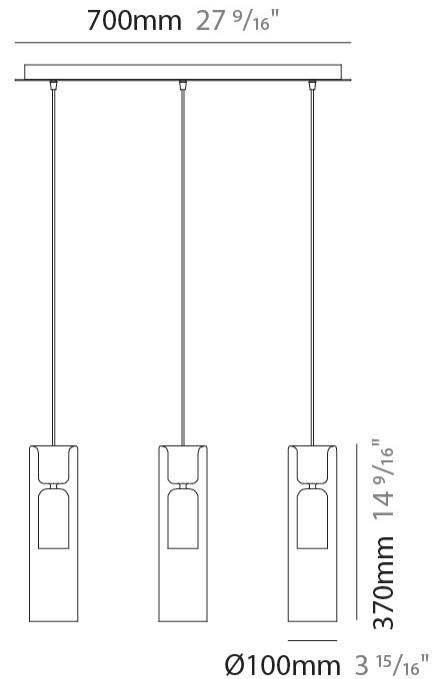

TAO 3 LIGHT LINEAR SUSPENSION

D141120-

PROJECT _____

TYPE _____

SPECIFIER _____

QUANTITY _____

DATE _____

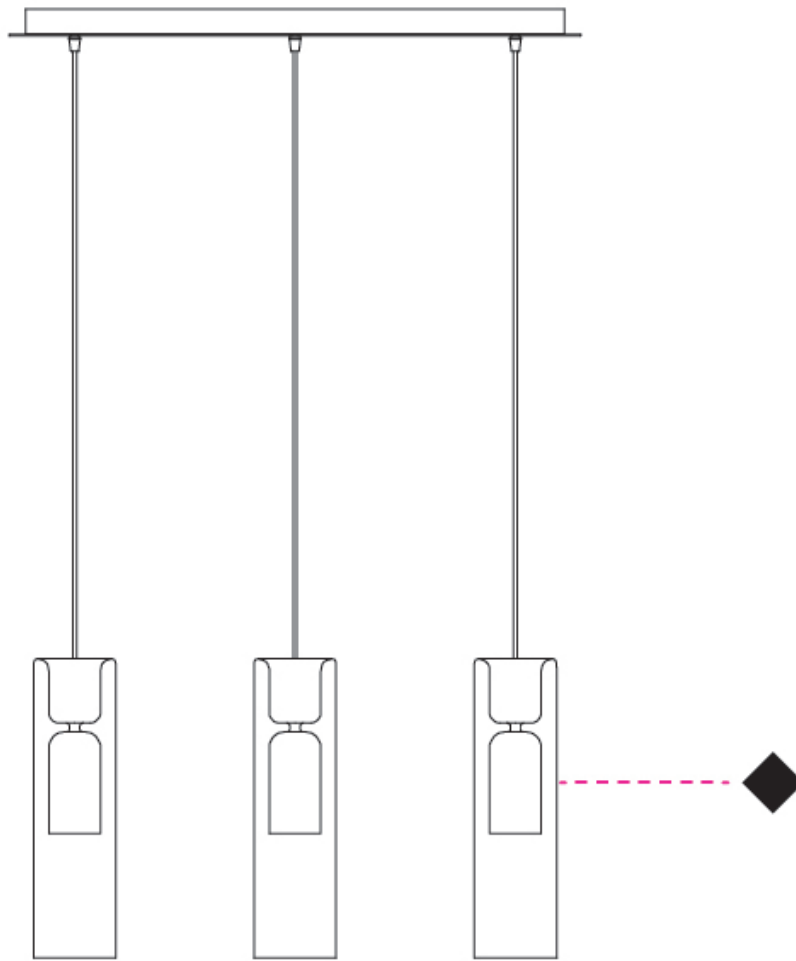

D

PROJECT _____
TYPE _____
SPECIFIER _____
QUANTITY _____
DATE _____

TAO COLOR FINISH CHART

Fixture Finish

Amber - AMB



Green - GRN



Pink - PNK



Ruby - RUB



Smoke - SMK



Tobacco - TOB



Transparent - TRA



Rose Gold - RGD

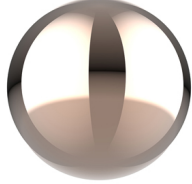

Titanium - TIM



Holder Finish

Chrome - CHR



Polished Stainless Steel - PSS



Digital: Not all screens are calibrated the same, and therefore, colors will appear differently between screens.

Physical: When texture is involved, there will be variations in color, character and tone within a product series and between product families.

PROJECT	
TYPE	
SPECIFIER	
QUANTITY	
DATE	

LEGEND

floor-mounted	pivotable	special LED (upon request) RGB, RGBW, tunable, gold+, meat+, art+, fashion+
wall and ceiling: recessed and surface mounted	rotating	warm dim / natural dimming LED
ceiling-mounted and wall-mounted	illuminate tilted	rechargeable battery powered
wall-mounted	color of suspension cable	fixture with natural vivid LED (upon request)
omni-directional light distribution	length of suspension cable	color rendering index
direct light distribution	reflector degree selection	color temperature
direct/indirect light distribution	super spot	lumen (luminous flux)
indirect light distribution	lens	efficacy (lumens per watt)
asymmetric light distribution	lens pack	Unified Glare Rating (UGR) range from 5-40
aura light distribution	shine ring	marine grade (AISI 316 stainless steel)
round wall or ceiling cut-out	integrated shine ring with diffuser	walk on
square wall or ceiling cut-out	free individual colors 01-29	drive on
the supplied jig specifies the cutout dimensions	individual colors: 00 (free of charge), 01-25 (extra charge)	Dark Sky Compliance
minimum distance (meters) lamp - object	luminaire part to be colored (F1)	Americans with Disabilities Act (less than 4" off the wall located between 27"-84" from floor)
recessed depth	luminaire part to be colored (F2)	lamp protected against explosion
ceiling thickness in mm	luminaire part to be colored (F3)	blown glass using traditional methods by master glass blower
ceiling thickness selection	luminaire part to be colored (F4)	acoustic material
dimmable DP (phase), DV (0-10V), DD (dali), DS (step-dim)	luminaire part to be colored (F5)	protection class I, protection insulation
included or excluded LED driver/transformer/control gear	color of 3-circuit adaptor	protection class II, protection insulation
separately switchable	indirect diffuser	ETL Certified to UL and CSA Standards
sensor	direct diffuser	UL Certified to UL and CSA Standards
remote control	ball-proof (upon request)	CSA Certified to UL and CSA Standards
available upon request	accessory	Certified for North American Standards

IP RATING

IP20	protected against ingress of solid bodies greater than 12.5mm (finger)
IP33	protected against ingress of solid bodies greater than 2.5mm protected against sprays of water up to 60 degrees from the vertical (rain)
IP40	protected against ingress of solid bodies greater than 1mm (wire) no protection against the ingress of moisture
IP43	protected against ingress of solid bodies greater than 1mm (wire) protected against sprays of water up to 60 degrees from the vertical (rain)
IP44	protected against ingress of solid bodies greater than 1mm (wire) protected against water splashed from all directions
IP54	protected against limited ingress of dust (wet rooms/covered outdoor areas) protected against water splashed from all directions
IP65	protected against ingress of dust protected against jets of water
IP66	protected against ingress of dust protected against powerful jets of water or heavy seas
IP67	protected against ingress of dust protected against immersion of water between 15cm - 1m for 30 minutes
IP68	protected against ingress of dust protected against immersion of water under pressure for long periods

IK RATING

IK01	protected against 0.14 joules impact (equivalent to 0.25kg mass dropped from 56mm above the surface)
IK02	protected against 0.2 joules impact (equivalent to 0.25kg mass dropped from 80mm above the surface)
IK03	protected against 0.35 joules impact (equivalent to 0.25kg mass dropped from 140mm above the surface)
IK04	protected against 0.5 joules impact (equivalent to 0.25kg mass dropped from 200mm above the surface)
IK05	protected against 0.7 joules impact (equivalent to 0.25kg mass dropped from 280mm above the surface)
IK06	protected against 1 joules impact (equivalent to 0.25kg mass dropped from 400mm above the surface)
IK07	protected against 2 joules impact (equivalent to 0.5kg mass dropped from 400mm above the surface)
IK08	protected against 5 joules impact (equivalent to 1.7kg mass dropped from 300mm above the surface)
IK09	protected against 10 joules impact (equivalent to 5.0kg mass dropped from 200mm above the surface)
IK10	protected against 20 joules impact (equivalent to 5.0kg mass dropped from 400mm above the surface)