

PROJECT \_\_\_\_\_  
 TYPE \_\_\_\_\_  
 SPECIFIER \_\_\_\_\_  
 QUANTITY \_\_\_\_\_  
 DATE \_\_\_\_\_

## TARGET SURFACE

**E9F233-** -  
 base number    Finish    Lens  
                     Options    Options

- To build a product code in our configurator select the specify button on the base model # product page
- To build a manual product code on this datasheet choose from the options listed below in blue font and add the suffix to the base model #

### GENERAL

Series: Target  
 Partner: Platek  
 Division: Exterior  
 Installation: Surface  
 Product Type: Flood  
 Mounting Location: Above Ground  
 Light Distribution: Adjustable

### PHYSICAL

Shape: Rectangle  
 Length (mm): 120  
 Length (in): 4 ¾  
 Width (mm): 70  
 Width (in): 2 ¾  
 Height (mm): 213  
 Height (in): 8 ⅜  
 Screws: A4 stainless steel  
 Diffuser: Clear tempered glass  
 Fixture Finish: [BLK / WHI / GRY / COR / ANT / BRZ](#)  
 Fixture Material: Aluminum Die Cast  
 Cable Details: 2000mm Cable

### ELECTRICAL

Lamp Type: LED  
 Total Output Wattage (W): 16  
 Dimming: DMX  
 Driver Included: No  
 Driver Location: Remote  
 Driver Type: Constant Current - Universal  
 Driver Class: Class 2  
 Input Voltage (V): 120 - 277  
 Constant Current (MA): 700

### LED

Number of LEDs: 8  
 Color Temperature (°K): RGBW  
 CRI: >80 CRI  
 Lamp Life (hrs): 60000  
 Special LEDs offerings: RGBW

### OPTICAL

Optic°: [9 / 24 / 48 / ELL](#)  
 Adjustability: Rotational 330°; Tilt 90°

### RATINGS AND CERTIFICATIONS

Certified By: Certified for North American Standards  
 IP rating: IP66  
 IK Rating: IK08  
 Bug Rating: B1 U0 G0

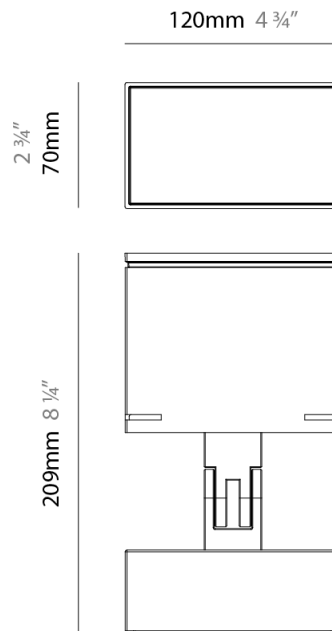

## TARGET SURFACE

E9F233-

PROJECT \_\_\_\_\_

TYPE \_\_\_\_\_

SPECIFIER \_\_\_\_\_

QUANTITY \_\_\_\_\_

DATE \_\_\_\_\_

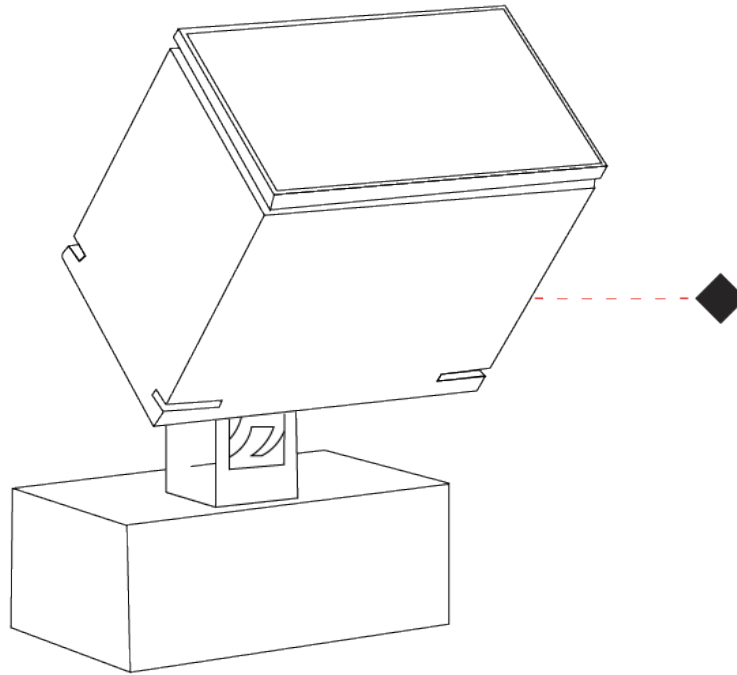

E

PROJECT \_\_\_\_\_  
 TYPE \_\_\_\_\_  
 SPECIFIER \_\_\_\_\_  
 QUANTITY \_\_\_\_\_  
 DATE \_\_\_\_\_

## TARGET SURFACE

### E9F234-

base number    Finish    Lens  
 Options        Options    Options

- To build a product code in our configurator select the specify button on the base model # product page
- To build a manual product code on this datasheet choose from the options listed below in blue font and add the suffix to the base model #

#### GENERAL

Series: Target  
 Partner: Platek  
 Division: Exterior  
 Installation: Surface  
 Product Type: Flood  
 Mounting Location: Above Ground  
 Light Distribution: Adjustable

#### PHYSICAL

Shape: Rectangle  
 Length (mm): 220  
 Length (in): 8 <sup>11</sup>/<sub>16</sub>  
 Width (mm): 70  
 Width (in): 2 <sup>3</sup>/<sub>4</sub>  
 Height (mm): 213  
 Height (in): 8 <sup>3</sup>/<sub>8</sub>  
 Screws: A4 stainless steel  
 Diffuser: Clear tempered glass  
 Fixture Finish: BLK / WHI / GRY / COR / ANT / BRZ  
 Fixture Material: Aluminum Die Cast  
 Cable Details: 2000mm Cable

#### ELECTRICAL

Lamp Type: LED  
 Total Output Wattage (W): 32  
 Dimming: DMX  
 Driver Included: No  
 Driver Location: Remote  
 Driver Type: Constant Current - Universal  
 Driver Class: Class 2  
 Input Voltage (V): 120 - 277  
 Constant Current (MA): 700

#### LED

Number of LEDs: 16  
 Color Temperature (°K): RGBW  
 CRI: >80 CRI  
 Lamp Life (hrs): 60000  
 Special LEDs offerings: RGBW

#### OPTICAL

Optic°: 9 / 24 / 48 / ELL  
 Adjustability: Rotational 330°; Tilt 90°

#### RATINGS AND CERTIFICATIONS

Certified By: Certified for North American Standards  
 IP rating: IP66  
 IK Rating: IK08  
 Bug Rating: B2 U0 G0

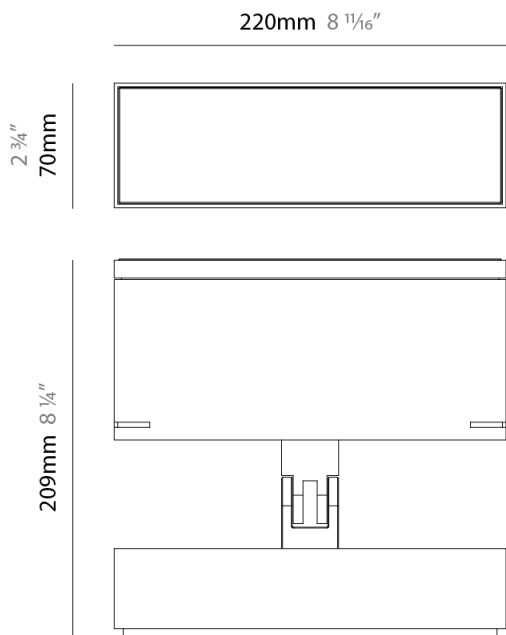

## TARGET SURFACE

E9F234-

PROJECT	_____
TYPE	_____
SPECIFIER	_____
QUANTITY	_____
DATE	_____

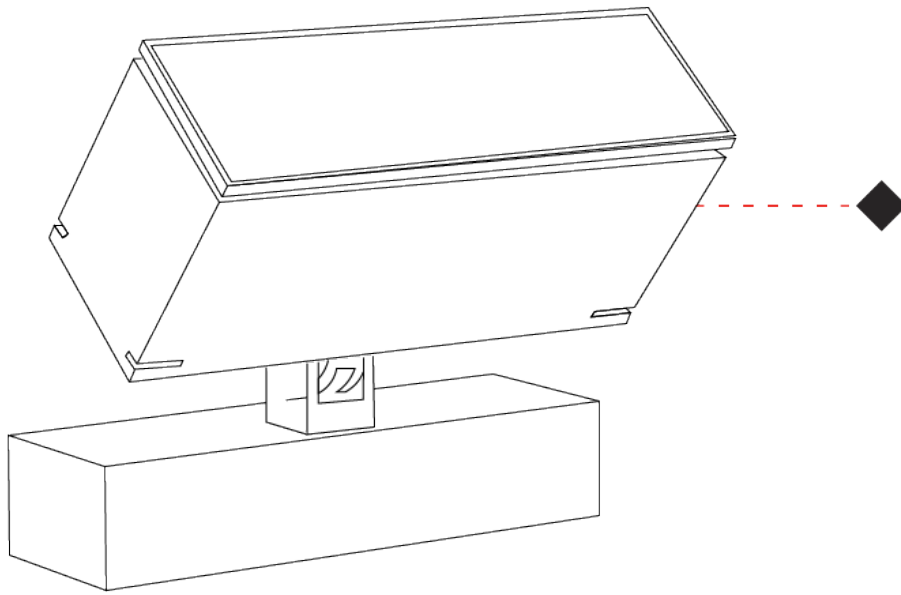

PROJECT
TYPE
SPECIFIER
QUANTITY
DATE

## TARGET SURFACE

### E9F304-

base number	Color	Finish	Lens
	Temperature	Options	Options

- To build a product code in our configurator select the specify button on the base model # product page
- To build a manual product code on this datasheet choose from the options listed below in blue font and add the suffix to the base model #

#### GENERAL

Series: Target
Partner: Platek
Division: Exterior
Installation: Surface
Product Type: Flood
Mounting Location: Above Ground
Light Distribution: Adjustable

#### PHYSICAL

Shape: Rectangle
Length (mm): 120
Length (in): 4 ¾
Width (mm): 40
Width (in): 1 ⅞
Height (mm): 191
Height (in): 7 ½
Screws: A4 stainless steel
Diffuser: Clear tempered glass
Fixture Finish: <a href="#">BLK</a> / <a href="#">WHI</a> / <a href="#">GRY</a> / <a href="#">COR</a> / <a href="#">ANT</a> / <a href="#">BRZ</a>
Fixture Material: Aluminum Die Cast

#### ELECTRICAL

Lamp Type: LED
Input Wattage (W): 10
Total Output Wattage (W): 8
Dimming: Non-Dimmable
Driver Included: Yes
Driver Location: Integrated
Driver Type: Constant Current - 120Vac
Driver Class: Class 2
Input Voltage (V): 120 - 277
Constant Current (mA): 700
Upon Request: Integral: Phase dimming 120Vac / Non-dimming 120/277Vac / Remote: 0-10Vdc dimming

#### LED

Number of LEDs: 4
Color Temperature (°K): <a href="#">3000</a> / <a href="#">4000</a>
Max. Delivered Lumen (lm): 725-790 / 755-820
Nominal Lumen (lm): 1000 / 1040
CRI: >80 CRI
Lamp Life (hrs): 60000

#### OPTICAL

Optic°: <a href="#">9</a> / <a href="#">24</a> / <a href="#">48</a> / <a href="#">ELL</a>
Adjustability: Rotational 330°; Tilt 90°

#### RATINGS AND CERTIFICATIONS

Certified By: Certified for North American Standards
IP rating: IP66
IK Rating: IK08
Bug Rating: B1 U0 G0

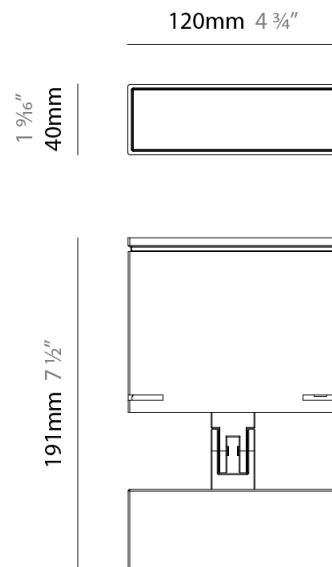

## TARGET SURFACE

E9F304-

PROJECT \_\_\_\_\_

TYPE \_\_\_\_\_

SPECIFIER \_\_\_\_\_

QUANTITY \_\_\_\_\_

DATE \_\_\_\_\_

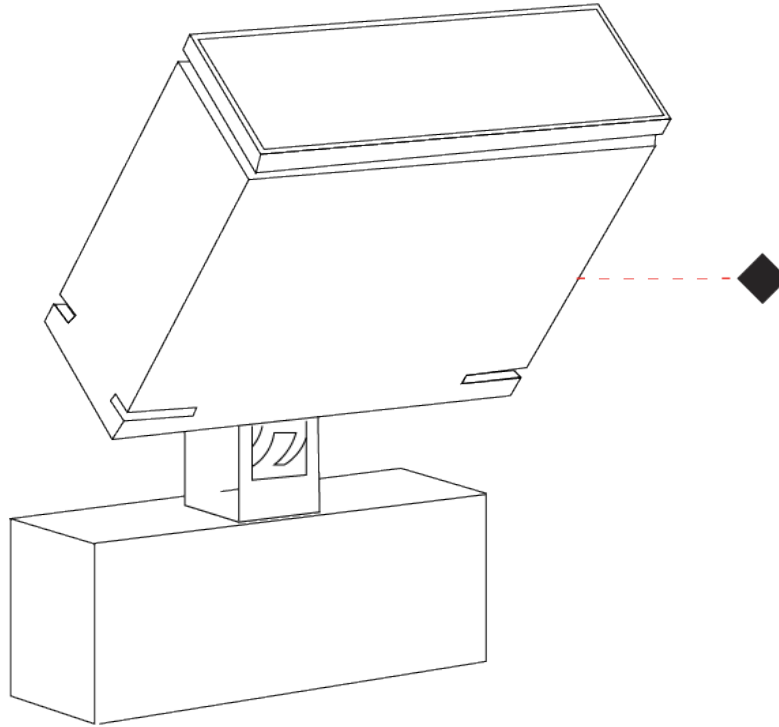

E

PROJECT
TYPE
SPECIFIER
QUANTITY
DATE

## TARGET SURFACE

### E9F312-

base number	Color	Finish	Lens
	Temperature	Options	Options

- To build a product code in our configurator select the specify button on the base model # product page
- To build a manual product code on this datasheet choose from the options listed below in blue font and add the suffix to the base model #

#### GENERAL

Series: Target
Partner: Platek
Division: Exterior
Installation: Surface
Product Type: Flood
Mounting Location: Above Ground
Light Distribution: Adjustable

#### PHYSICAL

Shape: Rectangle
Length (mm): 120
Length (in): 4 3/4
Width (mm): 70
Width (in): 2 3/4
Height (mm): 213
Height (in): 8 3/8
Screws: A4 stainless steel
Diffuser: Clear tempered glass
Fixture Finish: BLK / WHI / GRY / COR / ANT / BRZ
Fixture Material: Aluminum Die Cast

#### ELECTRICAL

Lamp Type: LED
Input Wattage (W): 20
Total Output Wattage (W): 16
Dimming: Non-Dimmable
Driver Included: Yes
Driver Location: Integrated
Driver Type: Constant Current - 120Vac
Driver Class: Class 2
Input Voltage (V): 120 - 277
Constant Current (mA): 700
Upon Request: Integral: Phase dimming 120Vac / Non-dimming 120/277Vac / Remote: 0-10Vdc dimming

#### LED

Number of LEDs: 8
Color Temperature (°K): 3000 / 4000
Max. Delivered Lumen (lm): 1615 / 1680
Nominal Lumen (lm): 2000 / 2080
CRI: >80 CRI
Lamp Life (hrs): 60000

#### OPTICAL

Optic: 9 / 24 / 48 / ELL
Adjustability: Rotational 330°; Tilt 90°

#### RATINGS AND CERTIFICATIONS

Certified By: Certified for North American Standards
IP rating: IP66
IK Rating: IK08
Bug Rating: B2 U0 G0

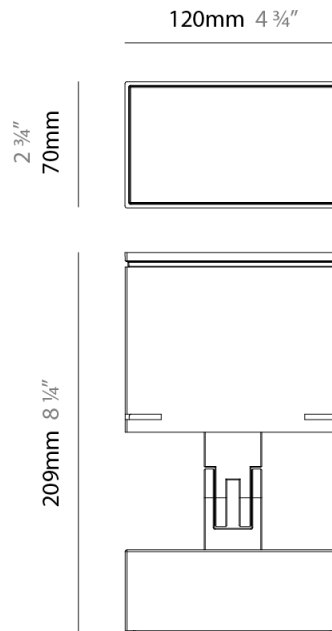

## TARGET SURFACE

E9F312-

PROJECT \_\_\_\_\_

TYPE \_\_\_\_\_

SPECIFIER \_\_\_\_\_

QUANTITY \_\_\_\_\_

DATE \_\_\_\_\_

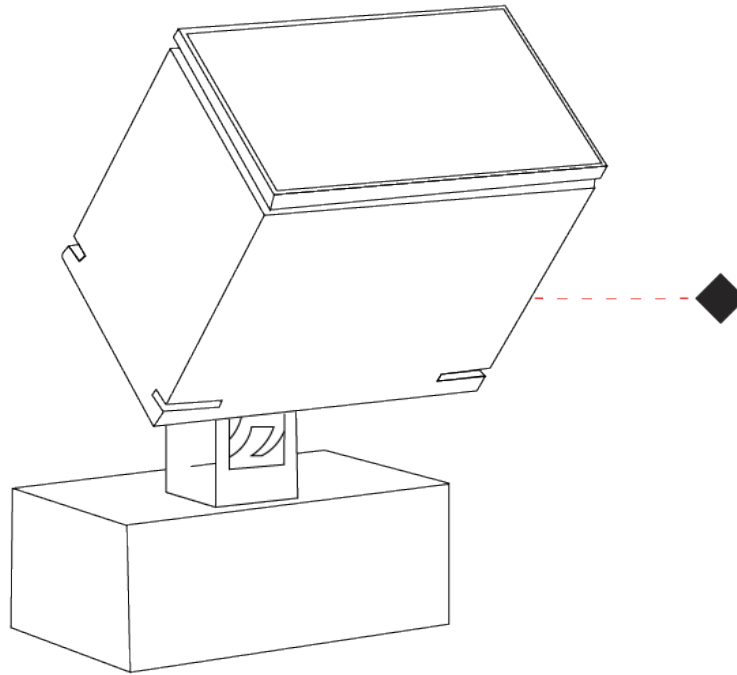

E

PROJECT
TYPE
SPECIFIER
QUANTITY
DATE

## TARGET SURFACE

### E9F320-

base number	Color	Finish	Lens
	Temperature	Options	Options

- To build a product code in our configurator select the specify button on the base model # product page
- To build a manual product code on this datasheet choose from the options listed below in blue font and add the suffix to the base model #

#### GENERAL

Series: Target
Partner: Platek
Division: Exterior
Installation: Surface
Product Type: Flood
Mounting Location: Above Ground
Light Distribution: Adjustable

#### PHYSICAL

Shape: Rectangle
Length (mm): 220
Length (in): 8 <sup>11</sup> / <sub>16</sub>
Width (mm): 70
Width (in): 2 <sup>3</sup> / <sub>4</sub>
Height (mm): 213
Height (in): 8 <sup>3</sup> / <sub>8</sub>
Screws: A4 stainless steel
Diffuser: Clear tempered glass
Fixture Finish: <a href="#">BLK / WHI / GRY / COR / ANT / BRZ</a>
Fixture Material: Aluminum Die Cast

#### ELECTRICAL

Lamp Type: LED
Input Wattage (W): 34
Total Output Wattage (W): 32
Dimming: Non-Dimmable
Driver Included: Yes
Driver Location: Integrated
Driver Type: Constant Current - Universal
Driver Class: Class 2
Input Voltage (V): 120 - 277
Constant Current (MA): 700
Upon Request: (Not included - see components [IP65 or higher enclosure to be supplied by others]) Remote: 0-10Vdc dimming / DMX

#### LED

Number of LEDs: 16
Color Temperature (°K): <a href="#">3000 / 4000</a>
Max. Delivered Lumen (lm): 3075 / 3200
Nominal Lumen (lm): 4000 / 4160
CRI: >80 CRI
Lamp Life (hrs): 60000

#### OPTICAL

Optic°: <a href="#">9 / 24 / 48 / ELL</a>
Adjustability: Rotational 330°; Tilt 90°

#### RATINGS AND CERTIFICATIONS

Certified By: Certified for North American Standards
IP rating: IP66
IK Rating: IK08
Bug Rating: B3 U0 G0

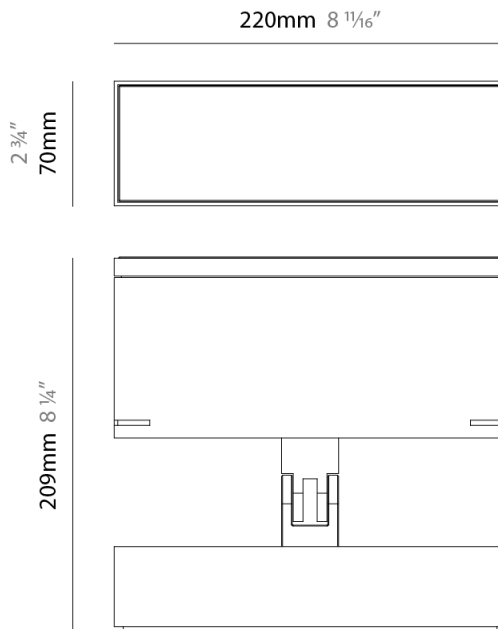

## TARGET SURFACE

E9F320-

PROJECT	_____
TYPE	_____
SPECIFIER	_____
QUANTITY	_____
DATE	_____

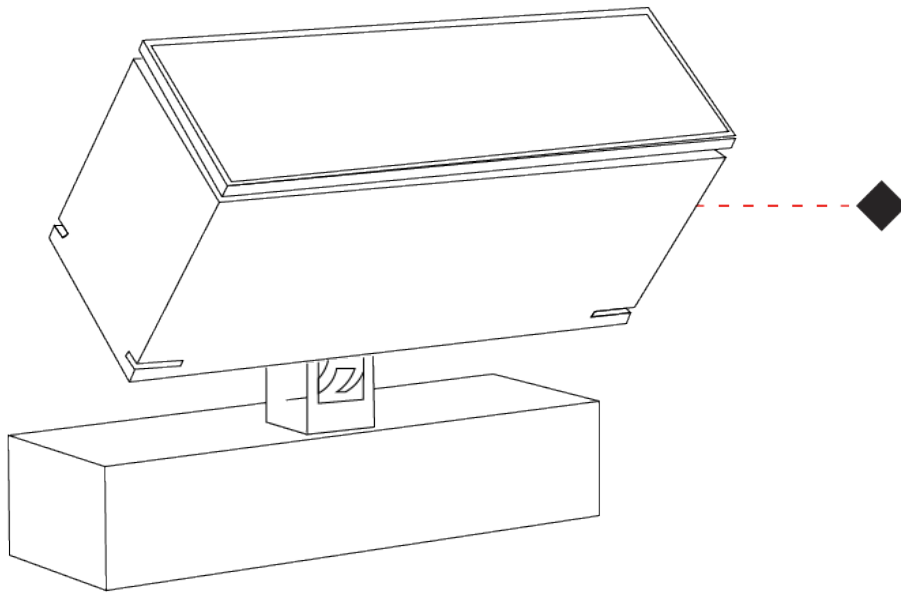

## TARGET COLOR FINISH CHART

PROJECT \_\_\_\_\_

TYPE \_\_\_\_\_

SPECIFIER \_\_\_\_\_

QUANTITY \_\_\_\_\_

DATE \_\_\_\_\_

### Fixture Finish

Black - BLK

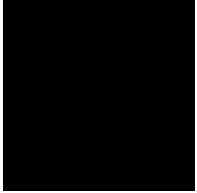

White - WHI

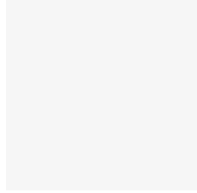

Grey - GRY

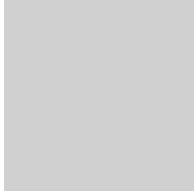

Corten - COR



Anthracite - ANT



Bronze - BRZ







































































**Digital:** Not all screens are calibrated the same, and therefore, colors will appear differently between screens.

**Physical:** When texture is involved, there will be variations in color, character and tone within a product series and between product families.



## TARGET

### LEGEND

	floor-mounted		pivotal		special LED (upon request) RGB, RGBW, tunable, gold+, meat+, art+, fashion+
	wall and ceiling: recessed and surface mounted		rotating		warm dim / natural dimming LED
	ceiling-mounted and wall-mounted		illuminate tilted		rechargeable battery powered
	wall-mounted		color of suspension cable		fixture with natural vivid LED (upon request)
	omni-directional light distribution		length of suspension cable		color rendering index
	direct light distribution		reflector degree selection		color temperature
	direct/indirect light distribution		super spot		lumen (luminous flux)
	indirect light distribution		lens		efficacy (lumens per watt)
	asymmetric light distribution		lens pack		Unified Glare Rating (UGR) range from 5-40
	aura light distribution		shine ring		marine grade (AISI 316 stainless steel)
	round wall or ceiling cut-out		integrated shine ring with diffuser		walk on
	square wall or ceiling cut-out		free individual colors 01-29		drive on
	the supplied jig specifies the cutout dimensions		individual colors: 00 (free of charge), 01-25 (extra charge)		Dark Sky Compliance
	minimum distance (meters) lamp - object		luminaire part to be colored (F1)		Americans with Disabilities Act (less than 4" off the wall located between 27"-84" from floor)
	recessed depth		luminaire part to be colored (F2)		lamp protected against explosion
	ceiling thickness in mm		luminaire part to be colored (F3)		blown glass using traditional methods by master glass blower
	ceiling thickness selection		luminaire part to be colored (F4)		acoustic material
	dimnable DP (phase), DV (0-10V), DD (dali), DS (step-dim)		luminaire part to be colored (F5)		protection class I, protection insulation
	included or excluded LED driver/transformer/control gear		color of 3-circuit adaptor		protection class II, protection insulation
	separately switchable		indirect diffuser		ETL Certified to UL and CSA Standards
	sensor		direct diffuser		UL Certified to UL and CSA Standards
	remote control		ball-proof (upon request)		CSA Certified to UL and CSA Standards
	available upon request		accessory		Certified for North American Standards

### IP RATING

	protected against ingress of solid bodies greater than 12.5mm (finger)
	protected against ingress of solid bodies greater than 2.5mm protected against sprays of water up to 60 degrees from the vertical (rain)
	protected against ingress of solid bodies greater than 1mm (wire) no protection against the ingress of moisture
	protected against ingress of solid bodies greater than 1mm (wire) protected against sprays of water up to 60 degrees from the vertical (rain)
	protected against ingress of solid bodies greater than 1mm (wire) protected against water splashed from all directions
	protected against limited ingress of dust (wet rooms/covered outdoor areas) protected against water splashed from all directions
	protected against ingress of dust protected against jets of water
	protected against ingress of dust protected against powerful jets of water or heavy seas
	protected against ingress of dust protected against immersion of water between 15cm - 1m for 30 minutes
	protected against ingress of dust protected against immersion of water under pressure for long periods

### IK RATING

	protected against 0.14 joules impact (equivalent to 0.25kg mass dropped from 56mm above the surface)
	protected against 0.2 joules impact (equivalent to 0.25kg mass dropped from 80mm above the surface)
	protected against 0.35 joules impact (equivalent to 0.25kg mass dropped from 140mm above the surface)
	protected against 0.5 joules impact (equivalent to 0.25kg mass dropped from 200mm above the surface)
	protected against 0.7 joules impact (equivalent to 0.25kg mass dropped from 280mm above the surface)
	protected against 1 joules impact (equivalent to 0.25kg mass dropped from 400mm above the surface)
	protected against 2 joules impact (equivalent to 0.5kg mass dropped from 400mm above the surface)
	protected against 5 joules impact (equivalent to 1.7kg mass dropped from 300mm above the surface)
	protected against 10 joules impact (equivalent to 5.0kg mass dropped from 200mm above the surface)
	protected against 20 joules impact (equivalent to 5.0kg mass dropped from 400mm above the surface)