

## TETRA PARCO POST

### E9B134-

base number                                                  
 Color                      Finish  
 Temperature              Options

- To build a product code in our configurator select the specify button on the base model # product page
- To build a manual product code on this datasheet choose from the options listed below in blue font and add the suffix to the base model #

#### GENERAL

Series: Tetra  
 Subseries: Tetra Parco  
 Brand: Platek  
 Division: Exterior  
 Mounting Type: Post  
 Mounting Location: Above Ground  
 Subcategory: Bollard

#### PHYSICAL

Shape: Rectangle  
 Length (mm): 140  
 Length (in): 5 1/2  
 Width (mm): 140  
 Width (in): 5 1/2  
 Height (mm): 1330  
 Height (in): 52 3/8  
 Light Distribution: Direct  
 Weight (kg): 12  
 Weight (lbs): 26.46  
 Screws: A4 stainless steel  
 Diffuser: Clear tempered glass  
 Fixture Finish: [BLK](#) / [WHI](#) / [GRY](#) / [COR](#) / [ANT](#) / [BRZ](#)  
 Fixture Material: Extruded Aluminum

#### ELECTRICAL

Lamp Type: LED  
 Input Wattage (W): 28  
 Total Output Wattage (W): 24  
 Dimming: Non-Dimming / Phase Dimming (120vac Only)  
 Driver Included: Yes  
 Driver Location: Integrated  
 Driver Type: Constant Current - 120 / 277Vac  
 Driver Class: Class 2  
 Input Voltage (V): 120 - 277  
 Constant Current (MA): 700  
 Upon Request: Remote: 0-10Vdc dimming

#### LED

Color Temperature (°K): [3000](#) / [4000](#)  
 Max. Delivered Lumen (lm): 1620 / 1685  
 Nominal Lumen (lm): 3685 / 3830  
 CRI: >80 CRI  
 Lamp Life (hrs): 60000

#### OPTICAL

#### RATINGS AND CERTIFICATIONS

Certified By: Certified for North American Standards  
 IP rating: IP65  
 IK Rating: IK10  
 Bug Rating: B1 U0 G1

PROJECT
TYPE
SPECIFIER
QUANTITY
DATE

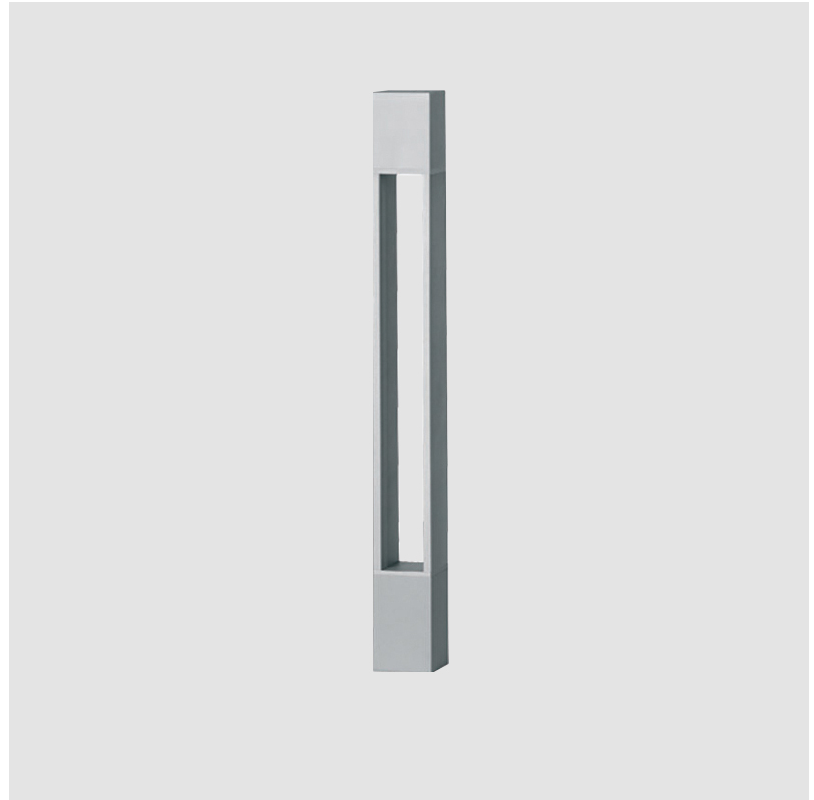

## TETRA PARCO POST

E9B134-

PROJECT

TYPE

SPECIFIER

QUANTITY

DATE

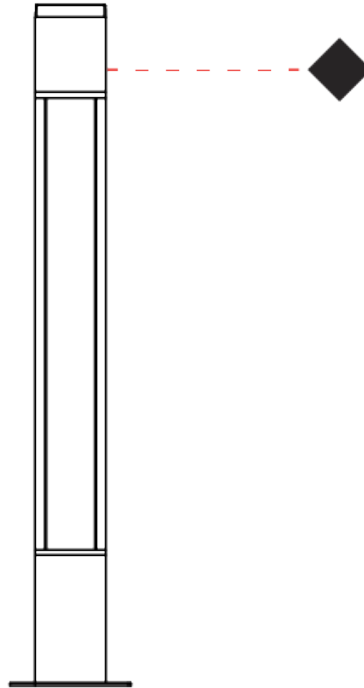

## TETRA PARCO POST

### E9B135-

base number    Color    Finish  
 Temperature    Options

- To build a product code in our configurator select the specify button on the base model # product page
- To build a manual product code on this datasheet choose from the options listed below in blue font and add the suffix to the base model #

#### GENERAL

Series: Tetra  
 Subseries: Tetra Parco  
 Brand: Platek  
 Division: Exterior  
 Mounting Type: Post  
 Mounting Location: Above Ground  
 Subcategory: Pedestrian

#### PHYSICAL

Shape: Rectangle  
 Length (mm): 140  
 Length (in): 5 1/2  
 Width (mm): 140  
 Width (in): 5 1/2  
 Height (mm): 1930  
 Height (in): 76  
 Light Distribution: Direct  
 Screws: A4 stainless steel  
 Diffuser: Clear tempered glass  
 Fixture Finish: [BLK / WHI / GRY / COR / ANT / BRZ](#)  
 Fixture Material: Extruded Aluminum

#### ELECTRICAL

Lamp Type: LED  
 Input Wattage (W): 28  
 Total Output Wattage (W): 24  
 Dimming: Non-Dimming / Phase Dimming (120vac Only)  
 Driver Included: Yes  
 Driver Location: Integrated  
 Driver Type: Constant Current - 120 / 277 Vac  
 Driver Class: Class 2  
 Input Voltage (V): 120 - 277  
 Constant Current (MA): 700  
 Upon Request: (Not included - see components [IP65 or higher enclosure to be supplied by others]) Remote: 0-10Vdc dimming / Non-dimming 120/277Vac

#### LED

Color Temperature (°K): [3000 / 4000](#)  
 Max. Delivered Lumen (lm): 1620 / 1685  
 Nominal Lumen (lm): 3685 / 3830  
 CRI: >80 CRI  
 Lamp Life (hrs): 60000

#### OPTICAL

#### RATINGS AND CERTIFICATIONS

Certified By: Certified for North American Standards  
 IP rating: IP65  
 IK Rating: IK10  
 Bug Rating: B1 U0 G1

PROJECT
TYPE
SPECIFIER
QUANTITY
DATE

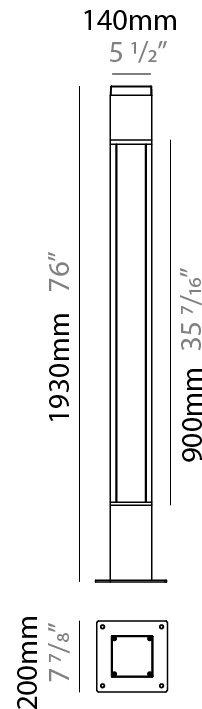
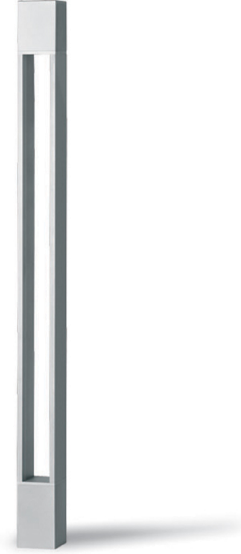

## TETRA PARCO POST

E9B135-

PROJECT \_\_\_\_\_

TYPE \_\_\_\_\_

SPECIFIER \_\_\_\_\_

QUANTITY \_\_\_\_\_

DATE \_\_\_\_\_

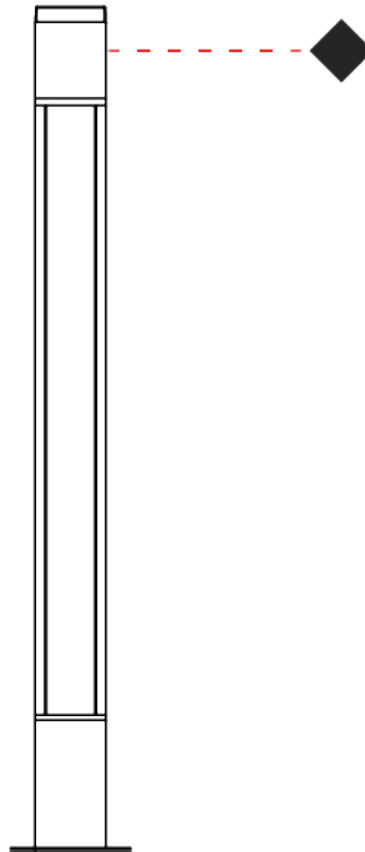

## TETRA PARCO POST

### E9B136-

base number    Color    Finish  
 Temperature    Options

- To build a product code in our configurator select the specify button on the base model # product page
- To build a manual product code on this datasheet choose from the options listed below in blue font and add the suffix to the base model #

#### GENERAL

Series: Tetra  
 Subseries: Tetra Parco  
 Brand: Platek  
 Division: Exterior  
 Mounting Type: Post  
 Mounting Location: Above Ground  
 Subcategory: Pedestrian

#### PHYSICAL

Shape: Rectangle  
 Length (mm): 140  
 Length (in): 5 1/2  
 Width (mm): 140  
 Width (in): 5 1/2  
 Height (mm): 2270  
 Height (in): 89 3/8  
 Light Distribution: Direct  
 Screws: A4 stainless steel  
 Diffuser: Clear tempered glass  
 Fixture Finish: [BLK / WHI / GRY / COR / ANT / BRZ](#)  
 Fixture Material: Extruded Aluminum

#### ELECTRICAL

Lamp Type: LED  
 Input Wattage (W): 41  
 Total Output Wattage (W): 38  
 Dimming: [Non-Dimming / Phase Dimming \(120vac Only\)](#)  
 Driver Included: Yes  
 Driver Location: Integrated  
 Driver Type: [Constant Current - 120 / 277Vac](#)  
 Driver Class: [Class 2](#)  
 Input Voltage (V): [120 - 277](#)  
 Constant Current (MA): 1050  
 Upon Request: (Not included - see components [IP65 or higher enclosure to be supplied by others]) Remote: [0-10Vdc dimming](#)

#### LED

[Color Temperature \(°K\): 3000 / 4000](#)  
 Max. Delivered Lumen (lm): 2390 / 2485  
 Nominal Lumen (lm): 4900 / 5145  
 CRI: [>80 CRI](#)  
 Lamp Life (hrs): 60000

#### OPTICAL

#### RATINGS AND CERTIFICATIONS

Certified By: [Certified for North American Standards](#)  
 IP rating: [IP65](#)  
 IK Rating: [IK10](#)  
 Bug Rating: [B1 U0 G1](#)

PROJECT
TYPE
SPECIFIER
QUANTITY
DATE

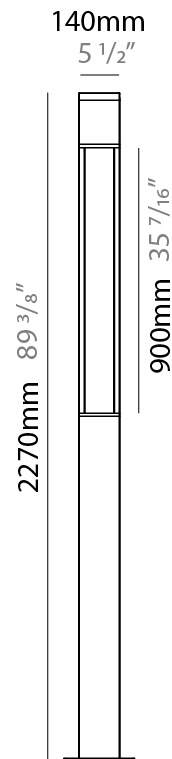

## TETRA PARCO POST

E9B136-

PROJECT \_\_\_\_\_

TYPE \_\_\_\_\_

SPECIFIER \_\_\_\_\_

QUANTITY \_\_\_\_\_

DATE \_\_\_\_\_

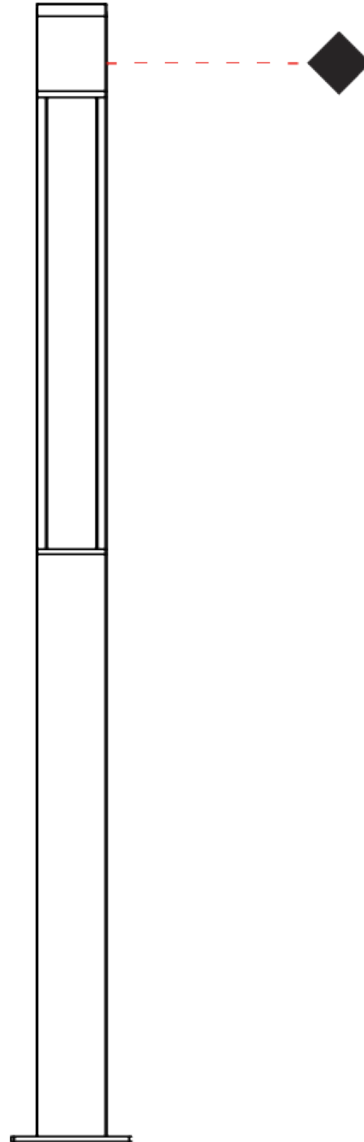

E

## TETRA PARCO POST

### E9B137-

base number                                            
 Color                      Finish  
 Temperature            Options

- To build a product code in our configurator select the specify button on the base model # product page
- To build a manual product code on this datasheet choose from the options listed below in blue font and add the suffix to the base model #

#### GENERAL

Series: Tetra  
 Subseries: Tetra Parco  
 Brand: Platek  
 Division: Exterior  
 Mounting Type: Post  
 Mounting Location: Above Ground  
 Subcategory: Pedestrian

#### PHYSICAL

Shape: Rectangle  
 Length (mm): 140  
 Length (in): 5 1/2  
 Width (mm): 140  
 Width (in): 5 1/2  
 Height (mm): 2600  
 Height (in): 102 3/8  
 Light Distribution: Direct  
 Screws: A4 stainless steel  
 Diffuser: Clear tempered glass  
 Fixture Finish: [BLK / WHI / GRY / COR / ANT / BRZ](#)  
 Fixture Material: Extruded Aluminum

#### ELECTRICAL

Lamp Type: LED  
 Input Wattage (W): 41  
 Total Output Wattage (W): 38  
 Dimming: Non-Dimming / Phase Dimming (120vac Only)  
 Driver Included: Yes  
 Driver Location: Integrated  
 Driver Type: Constant Current - 120 / 277Vac  
 Driver Class: Class 2  
 Input Voltage (V): 120 - 277  
 Constant Current (MA): 1050  
 Upon Request: (Not included - see components [IP65 or higher enclosure to be supplied by others]) Remote: 0-10Vdc dimming

#### LED

[Color Temperature \(°K\): 3000 / 4000](#)  
 Max. Delivered Lumen (lm): 2390 / 2485  
 Nominal Lumen (lm): 4900 / 5145  
 CRI: >80 CRI  
 Lamp Life (hrs): 60000

#### OPTICAL

#### RATINGS AND CERTIFICATIONS

Certified By: Certified for North American Standards  
 IP rating: IP65  
 IK Rating: IK10  
 Bug Rating: B1 U0 G1

PROJECT
TYPE
SPECIFIER
QUANTITY
DATE

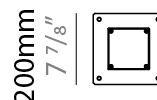
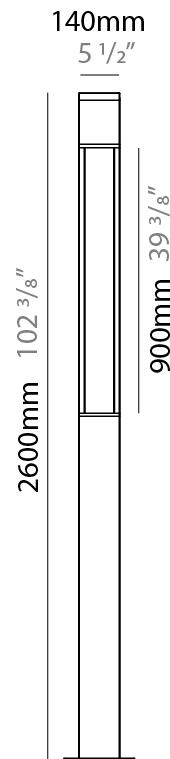
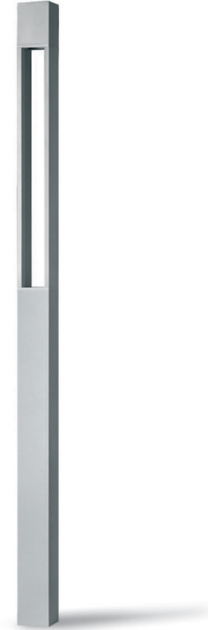

## TETRA PARCO POST

E9B137-

PROJECT

TYPE

SPECIFIER

QUANTITY

DATE

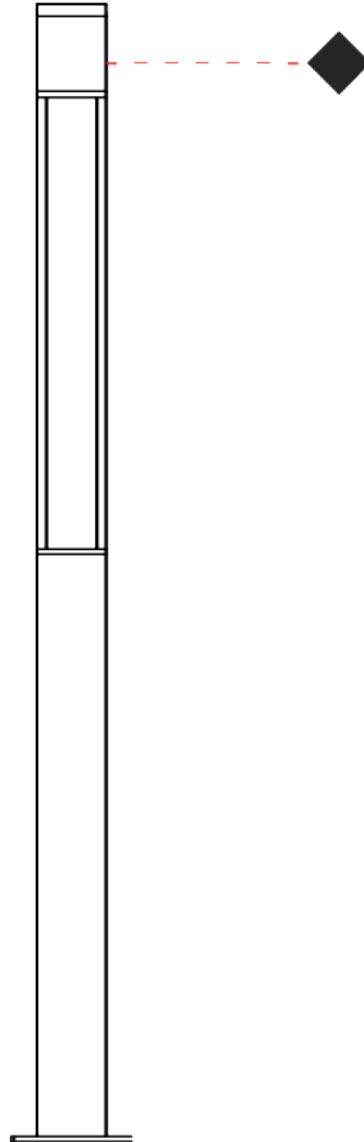

E



## TETRA INCASSO RECESSED

**E91368-** \_\_\_\_\_ - \_\_\_\_\_

base number    Color    Lens  
 Temperature    Options

- To build a product code in our configurator select the specify button on the base model # product page
- To build a manual product code on this datasheet choose from the options listed below in blue font and add the suffix to the base model #

### GENERAL

Series: Tetra  
 Subseries: Tetra Incasso  
 Brand: Platek  
 Division: Exterior  
 Mounting Type: Recessed  
 Mounting Location: In-Ground  
 Subcategory: Drive Over

### PHYSICAL

Shape: Rectangle  
 Length (mm): 1000  
 Length (in): 39 <sup>3</sup>/<sub>8</sub>  
 Width (mm): 130  
 Width (in): 5 <sup>1</sup>/<sub>8</sub>  
 Height (mm): 68  
 Height (in): 2 <sup>11</sup>/<sub>16</sub>  
 Light Distribution: Uplight  
 Weight (kg): 5.5  
 Weight (lbs): 12.12  
 Load Resistance (kg): 2000  
 Load Resistance (lbs): 4409  
 Installation Requirement: Installation in sleeve set in concrete with a 20 - 30 cm / 8 - 12 inches gravel drain bed  
 Screws: A4 stainless steel  
 Diffuser: Clear tempered glass  
 Gasket: Gore-Tex valve to prevent condensation inside the fitting.  
 Fixture Finish: SST  
 Fixture Material: Extruded Aluminum

### ELECTRICAL

Lamp Type: LED  
 Input Wattage (W): 47  
 Total Output Wattage (W): 16  
 Dimming: Non-Dimmable  
 Driver Included: Yes  
 Driver Location: Integrated  
 Driver Type: Constant Current - Universal  
 Driver Class: Class 2  
 Input Voltage (V): 120 - 277  
 Constant Current (MA): 350

### LED

Number of LEDs: 36  
 Color Temperature (°K): 3000 / 4000  
 Max. Delivered Lumen (lm): 1300 - 3230  
 Nominal Lumen (lm): 5040 / 5220  
 CRI: >80 CRI  
 Lamp Life (hrs): 60000

### OPTICAL

Optic°: 12 / 26 / 40 / ELI / ASY

### RATINGS AND CERTIFICATIONS

Certified By: Certified for North American Standards  
 IP rating: IP67  
 IK Rating: IK10  
 Bug Rating: B0 U5 G0

PROJECT
TYPE
SPECIFIER
QUANTITY
DATE

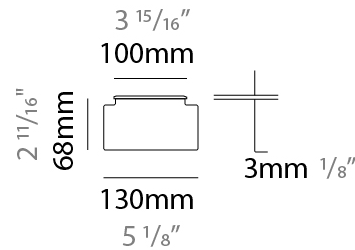
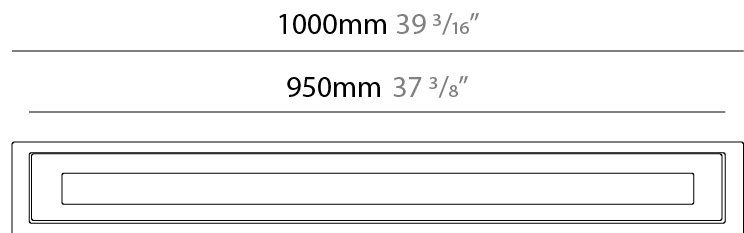
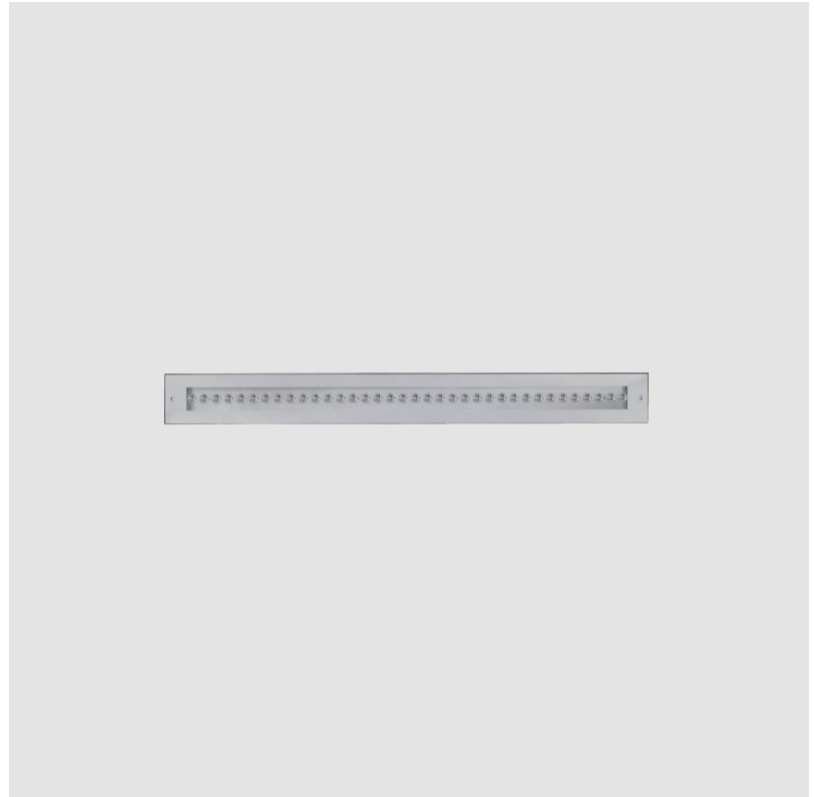

## TETRA INCASSO RECESSED

### E91399-

base number Color Lens  
 Temperature Options

- To build a product code in our configurator select the specify button on the base model # product page
- To build a manual product code on this datasheet choose from the options listed below in blue font and add the suffix to the base model #

#### GENERAL

Series: Tetra  
 Subseries: Tetra Incasso  
 Brand: Platek  
 Division: Exterior  
 Mounting Type: Recessed  
 Mounting Location: In-Ground  
 Subcategory: Walk Over

#### PHYSICAL

Shape: Rectangle  
 Length (mm): 450  
 Length (in): 17 3/4  
 Width (mm): 130  
 Width (in): 5 1/8  
 Height (mm): 68  
 Height (in): 2 11/16  
 Light Distribution: Uplight  
 Weight (kg): 3.1  
 Weight (lbs): 6.8  
 Load Resistance (kg): 500  
 Load Resistance (lbs): 1102  
 Installation Requirement: Installation in sleeve set in concrete with a 20 - 30 cm / 8 - 12 inches gravel drain bed  
 Screws: A4 stainless steel  
 Diffuser: Clear tempered glass  
 Gasket: Gore-Tex valve to prevent condensation inside the fitting.  
 Fixture Finish: SST  
 Fixture Material: Extruded Aluminum

#### ELECTRICAL

Lamp Type: LED  
 Input Wattage (W): 9.8 (Asy) / 13.5  
 Total Output Wattage (W): 8 (Asy) / 12  
 Dimming: Non-Dimming / Phase Dimming (120vac Only)  
 Driver Included: Yes  
 Driver Location: Integrated  
 Driver Type: Constant Current - 120 / 277Vac  
 Driver Class: Class 2  
 Input Voltage (V): 120 - 277  
 Constant Current (MA): 350  
 Upon Request: (Not included - see components [IP65 or higher enclosure to be supplied by others]) Remote: 0-10Vdc dimming

#### LED

Number of LEDs: 12  
 Color Temperature (°K): 3000 / 4000  
 Max. Delivered Lumen (lm): 1030 / 1070  
 Nominal Lumen (lm): 1680 / 1740  
 CRI: >80 CRI  
 Lamp Life (hrs): 60000

#### OPTICAL

Optic°: 12 / 26 / 40 / ELI / ASY

#### RATINGS AND CERTIFICATIONS

Certified By: Certified for North American Standards  
 IP rating: IP67  
 IK Rating: IK10  
 Bug Rating: B0 U4 G0

Zaneen Inc. 10604, T 1800-388-3382, F 416-247-9319, www.zaneen.com

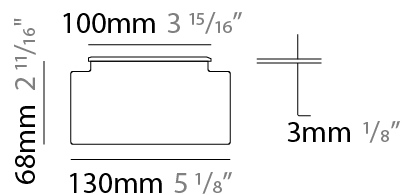
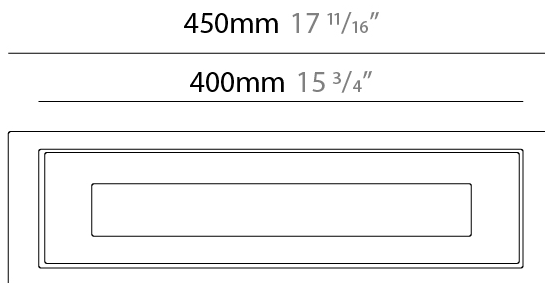

PROJECT
TYPE
SPECIFIER
QUANTITY
DATE

## TETRA INCASSO RECESSED

### E91462-

base number Color Lens  
Temperature Options

- To build a product code in our configurator select the specify button on the base model # product page
- To build a manual product code on this datasheet choose from the options listed below in blue font and add the suffix to the base model #

#### GENERAL

Series: Tetra  
Subseries: Tetra Incasso  
Brand: Platek  
Division: Exterior  
Mounting Type: Recessed  
Mounting Location: In-Ground  
Subcategory: Walk Over

#### PHYSICAL

Shape: Rectangle  
Length (mm): 450  
Length (in): 17 11/16  
Width (mm): 130  
Width (in): 5 1/8  
Height (mm): 68  
Height (in): 2 11/16  
Light Distribution: Uplight  
Weight (kg): 3.2  
Weight (lbs): 7.05  
Load Resistance (kg): 500  
Load Resistance (lbs): 1102  
Installation Requirement: Installation in sleeve set in concrete with a 20-30 cm gravel drain bed  
Screws: A4 stainless steel  
Diffuser: Clear tempered glass  
Gasket: Gore-Tex valve to prevent condensation inside the fitting.  
Fixture Finish: SST  
Fixture Material: Extruded Aluminum

#### ELECTRICAL

Lamp Type: LED  
Input Wattage (W): 7.3  
Total Output Wattage (W): 6 / 11.5 (RGBW)  
Dimming: Non-Dimmable  
Control Gear: DMX  
Driver Included: Yes (excluding RGBW)  
Driver Location: Integrated / RGBW - Remote  
Driver Type: White LED - Constant Voltage - Universal  
Driver Class: Class 2  
Input Voltage (V): 120 - 277  
Output Voltage (V): 24  
Constant Current (MA): RGBW 500  
Upon Request: (Not included - see components [IP65 or higher enclosure to be supplied by others]) Remote: DMX / 0-10Vdc dimming / Phase dimming

#### LED

Number of LEDs: 6 / 8 (RGBW)  
Color Temperature (°K): 3000 / 4000 / RGBW  
Max. Delivered Lumen (lm): 515 / 535  
Nominal Lumen (lm): 840 / 870  
CRI: >80 CRI  
Lamp Life (hrs): 60000

#### OPTICAL

Optic: 12 / 26 / 40 / ELI / ASY

#### RATINGS AND CERTIFICATIONS

Certified By: Certified for North American Standards  
© 2024, T 1800-388-3382, F 416-247-9319, www.zaneen.com  
Available for international specifications by adding 'INT' at the end of the existing Model #. For assistance on 'custom' specifications, contact zteam@zaneen.com.  
In a constant effort to supply the best product, we reserve the right to change specifications or materials without notice. The most recent specification sheets are found at zaneen.com  
Bug Rating: B0 U3 G0

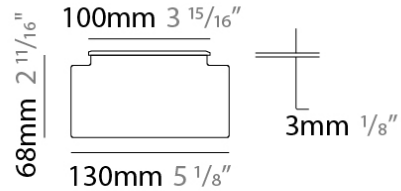

## TETRA INCASSO RECESSED

### E91470-

base number    Color    Lens  
 Temperature    Options

- To build a product code in our configurator select the specify button on the base model # product page
- To build a manual product code on this datasheet choose from the options listed below in blue font and add the suffix to the base model #

#### GENERAL

Series: Tetra  
 Subseries: Tetra Incasso  
 Brand: Platek  
 Division: Exterior  
 Mounting Type: Recessed  
 Mounting Location: In-Ground  
 Subcategory: Drive Over

#### PHYSICAL

Shape: Rectangle  
 Length (mm): 1000  
 Length (in): 39 <sup>3</sup>/<sub>8</sub>  
 Width (mm): 130  
 Width (in): 5 <sup>1</sup>/<sub>8</sub>  
 Height (mm): 68  
 Height (in): 2 <sup>11</sup>/<sub>16</sub>  
 Light Distribution: Uplight  
 Weight (kg): 6.7  
 Weight (lbs): 14.77  
 Load Resistance (kg): 2000  
 Load Resistance (lbs): 4409  
 Installation Requirement: Installation in sleeve set in concrete with a 20-30 cm gravel drain bed  
 Screws: A4 stainless steel  
 Diffuser: Clear tempered glass  
 Gasket: Gore-Tex valve to prevent condensation inside the fitting.  
 Fixture Finish: SST  
 Fixture Material: Extruded Aluminum

#### ELECTRICAL

Lamp Type: LED  
 Input Wattage (W): 21  
 Total Output Wattage (W): 18 / RGBW 35W  
 Dimming: Non-Dimmable  
 Control Gear: DMX  
 Driver Included: Yes (excluding RGBW)  
 Driver Location: Integrated / RGBW - Remote  
 Driver Type: White LED - Constant Voltage - 120Vac  
 Driver Class: Class 2  
 Input Voltage (V): 120 - 277  
 Output Voltage (V): 24  
 Constant Current (MA): RGBW 500  
 Upon Request: Remote: DMX / Non-dimming 120/277Vac / 0-10Vdc dimming / Phase dimming @120Vac only

#### LED

Number of LEDs: 18 / RGBW 24  
 Color Temperature (°K): 3000 / 4000 / RGBW  
 Max. Delivered Lumen (lm): 1540 - 1600  
 Nominal Lumen (lm): 2520 / 2610  
 CRI: >80 CRI  
 Lamp Life (hrs): 60000

#### OPTICAL

Optic°: 12 / 26 / 40 / Elliptical

#### RATINGS AND CERTIFICATIONS

Certified By: Certified for North American Standards

IP Rating: IP67  
 © 2024, T 1800-388-3382, F 416-247-9319, www.zaneen.com

For international specifications by adding 'INT' at the end of the existing Model #. For assistance on 'custom' specifications, contact zteam@zaneen.com.  
 To ensure that we supply the best product, we reserve the right to change specifications or materials without notice. The most recent specification sheets are found at zaneen.com

PROJECT
TYPE
SPECIFIER
QUANTITY
DATE

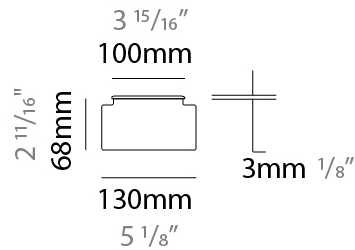
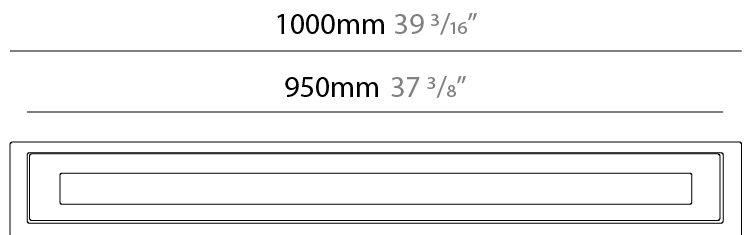
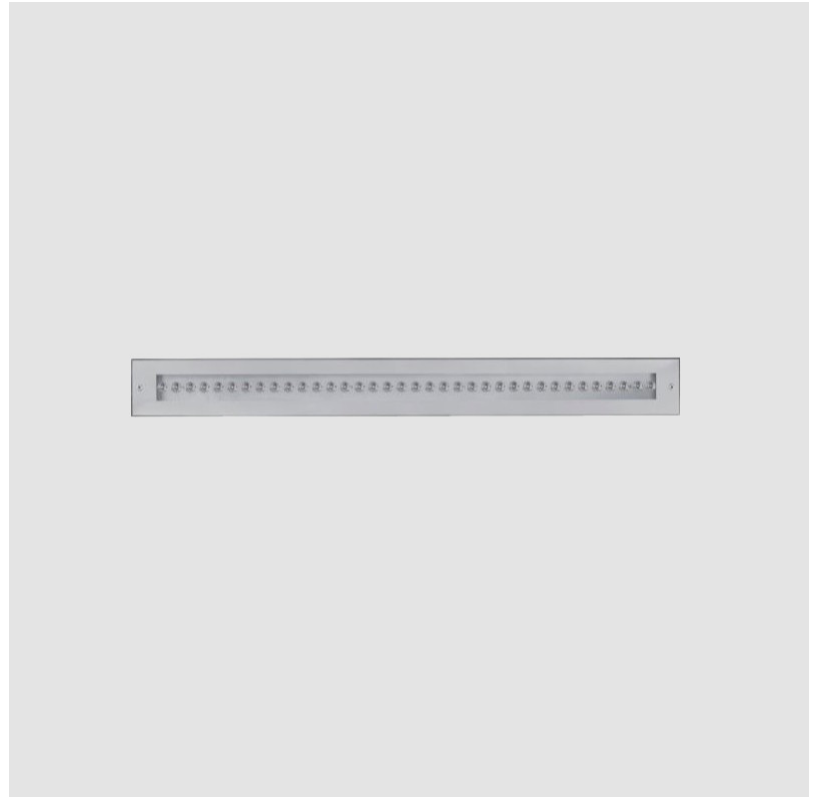

## TETRA INCASSO RECESSED

### E9I625-

base number Lens  
Options

- To build a product code in our configurator select the specify button on the base model # product page
- To build a manual product code on this datasheet choose from the options listed below in blue font and add the suffix to the base model #

#### GENERAL

Series: Tetra  
Subseries: Tetra Incasso  
Brand: Platek  
Division: Exterior  
Mounting Type: Recessed  
Mounting Location: In-Ground  
Subcategory: Walk Over

#### PHYSICAL

Shape: Rectangle  
Length (mm): 450  
Length (in): 17 <sup>11</sup>/<sub>16</sub>"  
Width (mm): 130  
Width (in): 5 <sup>1</sup>/<sub>8</sub>"  
Height (mm): 68  
Height (in): 2 <sup>11</sup>/<sub>16</sub>"  
Light Distribution: Uplight  
Weight (kg): 3.2  
Weight (lbs): 7.05  
Load Resistance (kg): 500  
Load Resistance (lbs): 1102  
Installation Requirement: Installation in sleeve set in concrete with a 20-30 cm gravel drain bed  
Screws: A4 stainless steel  
Diffuser: Clear tempered glass  
Gasket: Gore-Tex valve to prevent condensation inside the fitting.  
Fixture Finish: SST  
Fixture Material: Extruded Aluminum

#### ELECTRICAL

Lamp Type: LED  
Input Wattage (W): 11.5  
Control Gear: DMX  
Driver Included: No  
Driver Location: Remote  
Driver Class: Class 2  
Input Voltage (V): 120 - 277  
Constant Current (MA): 500

#### LED

Number of LEDs: 6  
Color Temperature (°K): RGBW  
CRI: >80 CRI  
Lamp Life (hrs): 60000  
Special LEDs offerings: RGBW

#### OPTICAL

Optic°: 12 / 26 / 40 / Elliptical

#### RATINGS AND CERTIFICATIONS

Certified By: Certified for North American Standards  
IP rating: IP67  
IK Rating: IK10

PROJECT
TYPE
SPECIFIER
QUANTITY
DATE

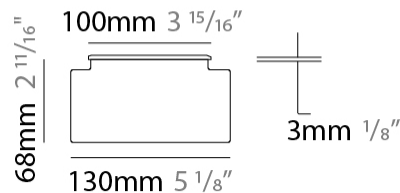
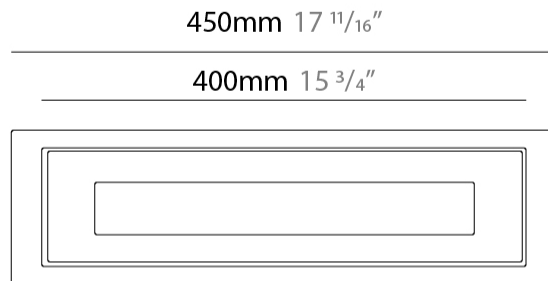
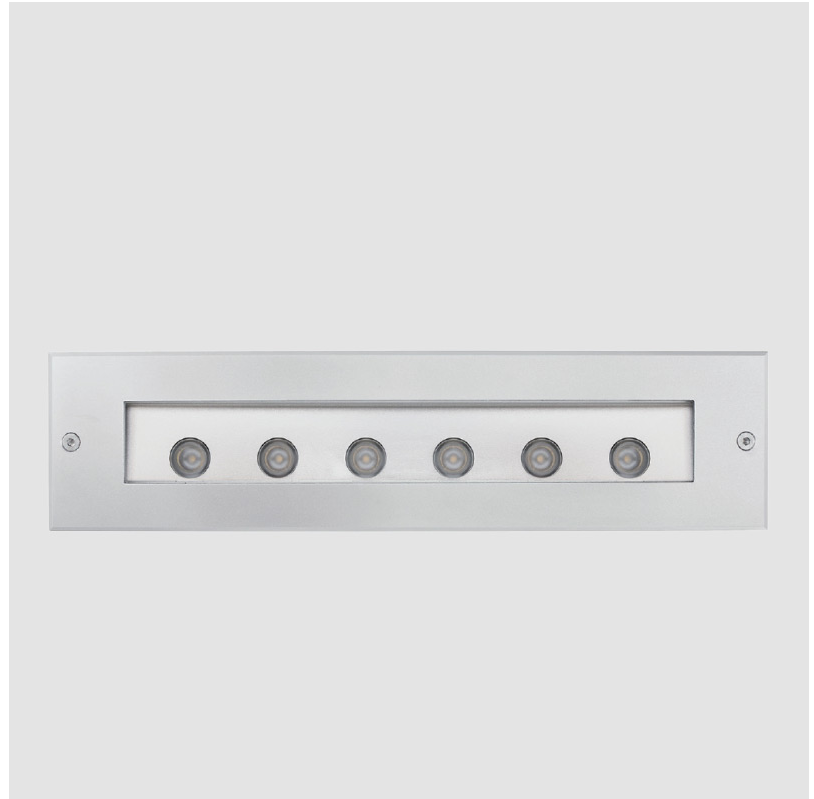

## TETRA LINEAR SURFACE

### E9W165-

base number    Color    Finish    Lens  
 Temperature    Options    Options

- To build a product code in our configurator select the specify button on the base model # product page
- To build a manual product code on this datasheet choose from the options listed below in blue font and add the suffix to the base model #

#### GENERAL

Series: Tetra  
 Subseries: Tetra Linear  
 Brand: Platek  
 Division: Exterior  
 Mounting Type: Surface  
 Mounting Location: Wall  
 Subcategory: Wallwash

#### PHYSICAL

Shape: Rectangle  
 Length (mm): 904  
 Length (in): 35 <sup>9</sup>/<sub>16</sub>  
 Width (mm): 65  
 Width (in): 2 <sup>9</sup>/<sub>16</sub>  
 Height (mm): 65  
 Depth (mm): 136  
 Height (in): 2 <sup>9</sup>/<sub>16</sub>  
 Depth (in): 5 <sup>3</sup>/<sub>8</sub>  
 Light Distribution: Adjustable / Direct  
 Weight (kg): 4  
 Weight (lbs): 8.8  
 Screws: A4 stainless steel  
 Diffuser: Clear tempered glass  
 Gasket: Gore-Tex valve to prevent condensation inside the fitting.  
 Fixture Finish: [BLK](#) / [WHI](#) / [GRY](#) / [COR](#) / [ANT](#) / [BRZ](#)  
 Fixture Material: Extruded Aluminum

#### ELECTRICAL

Lamp Type: LED  
 Input Wattage (W): 21  
 Total Output Wattage (W): 18  
 Dimming: Non-Dimmable  
 Driver Included: Yes  
 Driver Location: Integrated  
 Driver Type: Constant Voltage - 120Vac  
 Driver Class: Class 2  
 Input Voltage (V): 120 - 277  
 Output Voltage (V): 24  
 Upon Request: (Not included - see components [IP65 or higher enclosure to be supplied by others]) Remote: Non-dimming 120/277Vac

#### LED

Number of LEDs: 18  
 Color Temperature (°K): [3000](#) / [4000](#)  
 Max. Delivered Lumen (lm): 1500 / 1560  
 Nominal Lumen (lm): 2520 / 2610  
 CRI: >80 CRI  
 Lamp Life (hrs): 60000

#### OPTICAL

Optic°: [12](#) / [40](#) / [Elliptical](#)  
 Adjustability: Tilt ±45°

#### RATINGS AND CERTIFICATIONS

Certified By: Certified for North American Standards  
 IP rating: IP65  
 IK Rating: IK07  
 Bug Rating: B2 U1 G0

Zaneen Group Inc. © 2024, T 1800-388-3382, F 416-247-9319, www.zaneen.com

Available for International specifications by adding 'INT' at the end of the existing Model #. For assistance on 'custom' specifications, contact zteam@zaneen.com. In a constant effort to supply the best product, we reserve the right to change specifications or materials without notice. The most recent specification sheets are found at zaneen.com

PROJECT
TYPE
SPECIFIER
QUANTITY
DATE

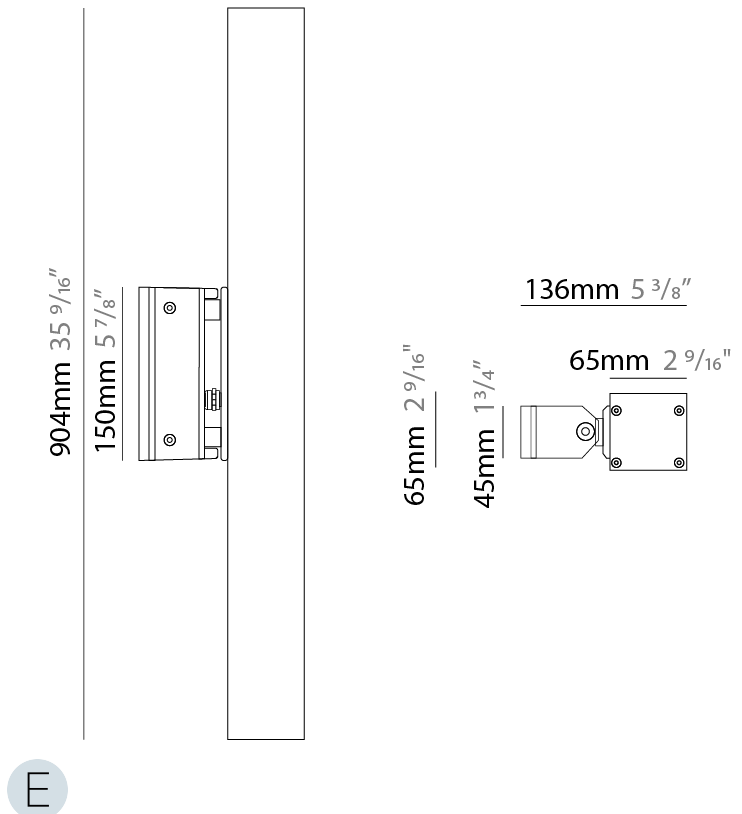

## TETRA LINEAR SURFACE

E9W165-

PROJECT

TYPE

SPECIFIER

QUANTITY

DATE

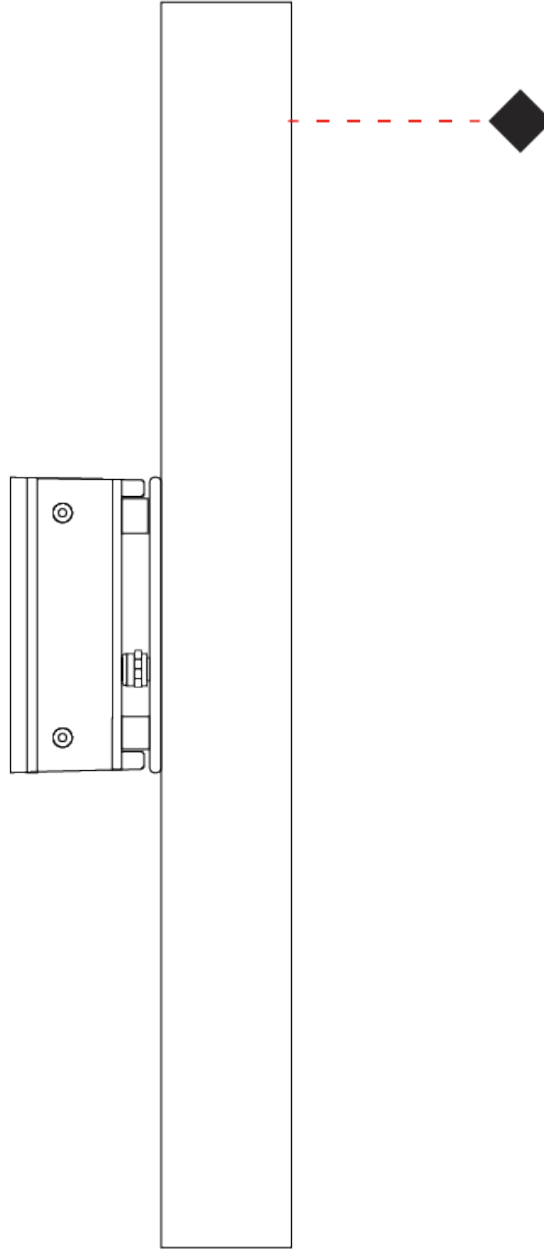

E

## TETRA LINEAR SURFACE

### E9W177-

base number    Color    Finish    Lens  
 Temperature    Options    Options

- To build a product code in our configurator select the specify button on the base model # product page
- To build a manual product code on this datasheet choose from the options listed below in blue font and add the suffix to the base model #

#### GENERAL

Series: Tetra  
 Subseries: Tetra Linear  
 Brand: Platek  
 Division: Exterior  
 Mounting Type: Surface  
 Mounting Location: Wall  
 Subcategory: Wallwash

#### PHYSICAL

Shape: Rectangle  
 Length (mm): 904  
 Length (in): 35 <sup>9</sup>/<sub>16</sub>  
 Width (mm): 65  
 Width (in): 2 <sup>9</sup>/<sub>16</sub>  
 Height (mm): 65  
 Depth (mm): 136  
 Height (in): 2 <sup>9</sup>/<sub>16</sub>  
 Depth (in): 5 <sup>3</sup>/<sub>8</sub>  
 Light Distribution: Adjustable / Direct  
 Weight (kg): 5.8  
 Weight (lbs): 12.8  
 Screws: A4 stainless steel  
 Diffuser: Clear tempered glass  
 Gasket: Gore-Tex valve to prevent condensation inside the fitting.  
 Fixture Finish: [BLK / WHI / GRY / COR / ANT / BRZ](#)  
 Fixture Material: Extruded Aluminum

#### ELECTRICAL

Lamp Type: LED  
 Input Wattage (W): 47  
 Total Output Wattage (W): 36  
 Dimming: Non-Dimmable  
 Driver Included: Yes  
 Driver Location: Integrated  
 Driver Type: Constant Current - Universal  
 Driver Class: Class 2  
 Input Voltage (V): 120 - 277  
 Constant Current (MA): 350

#### LED

Number of LEDs: 18  
 Color Temperature (°K): [3000 / 4000](#)  
 Max. Delivered Lumen (lm): 3000 / 3120  
 Nominal Lumen (lm): 5040 / 5220  
 CRI: >80 CRI  
 Lamp Life (hrs): 60000

#### OPTICAL

Optic°: [12 / 40 / Elliptical](#)  
 Adjustability: Tilt ±45°

#### RATINGS AND CERTIFICATIONS

Certified By: Certified for North American Standards  
 IP rating: IP65  
 IK Rating: IK07  
 Bug Rating: B3 U1 G1

PROJECT
TYPE
SPECIFIER
QUANTITY
DATE

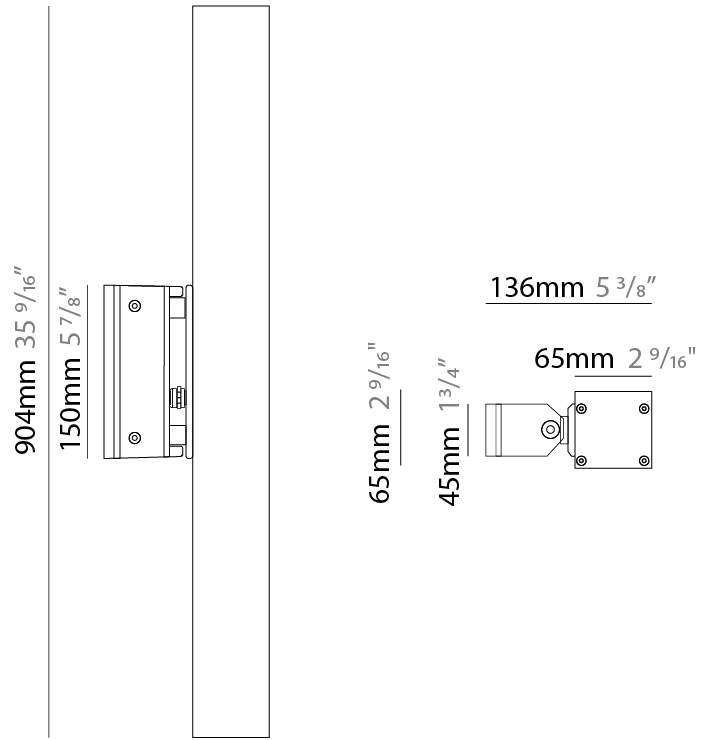



## TETRA LINEAR SURFACE

E9W177-

PROJECT

TYPE

SPECIFIER

QUANTITY

DATE

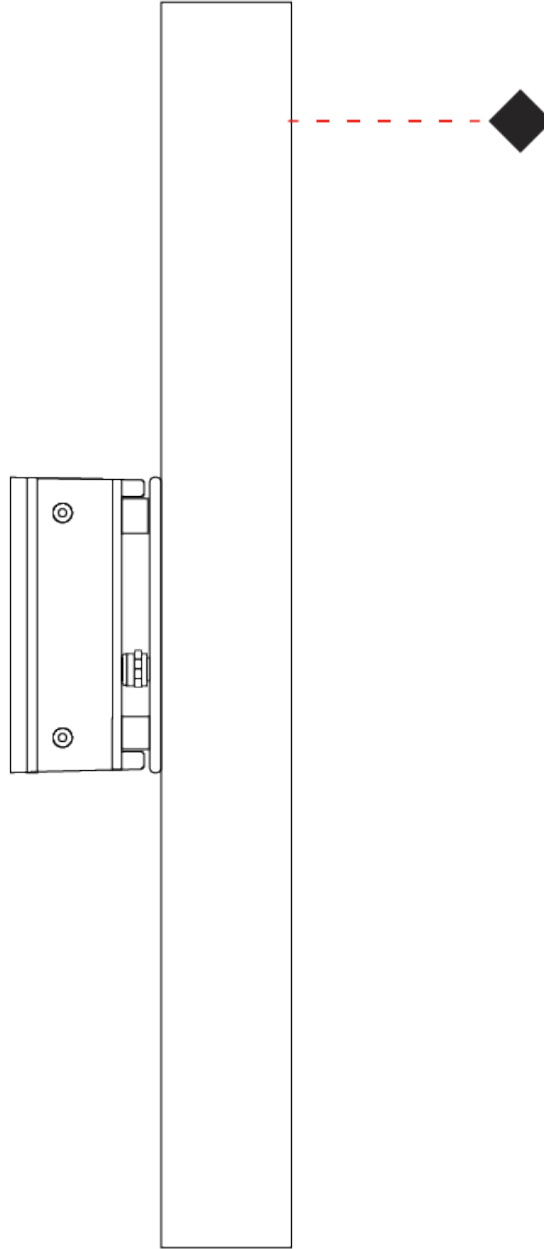

E

PROJECT
TYPE
SPECIFIER
QUANTITY
DATE

## TETRA LINEAR SURFACE

**E9W189-** - -  
 base number    Color    Finish    Lens  
                          Temperature    Options    Options

- To build a product code in our configurator select the specify button on the base model # product page
- To build a manual product code on this datasheet choose from the options listed below in blue font and add the suffix to the base model #

### GENERAL

Series: Tetra  
 Subseries: Tetra Linear  
 Brand: Platek  
 Division: Exterior  
 Mounting Type: Surface  
 Mounting Location: Wall  
 Subcategory: Wallwash

### PHYSICAL

Shape: Rectangle  
 Length (mm): 358  
 Length (in): 14 1/8  
 Width (mm): 65  
 Width (in): 2 9/16  
 Height (mm): 65  
 Depth (mm): 136  
 Height (in): 2 9/16  
 Depth (in): 5 3/8  
 Light Distribution: Adjustable / Direct  
 Weight (kg): 2.6  
 Weight (lbs): 5.73  
 Screws: A4 stainless steel  
 Diffuser: Clear tempered glass  
 Gasket: Gore-Tex valve to prevent condensation inside the fitting.  
 Fixture Finish: [BLK](#) / [WHI](#) / [GRY](#) / [COR](#) / [ANT](#) / [BRZ](#)  
 Fixture Material: Extruded Aluminum

### ELECTRICAL

Lamp Type: LED  
 Input Wattage (W): 7.3  
 Total Output Wattage (W): 6  
 Dimming: Non-Dimmable  
 Driver Included: Yes  
 Driver Location: Integrated  
 Driver Type: Constant Voltage - Universal  
 Driver Class: Class 2  
 Input Voltage (V): 120 - 277  
 Output Voltage (V): 24

### LED

Color Temperature (°K): [3000](#) / [4000](#)  
 Max. Delivered Lumen (lm): 490 / 520  
 Nominal Lumen (lm): 840 / 870  
 CRI: >80 CRI  
 Lamp Life (hrs): 60000

### OPTICAL

Optic°: [12](#) / [40](#) / [Elliptical](#)  
 Adjustability: Tilt ±45°

### RATINGS AND CERTIFICATIONS

Certified By: Certified for North American Standards  
 IP rating: IP65  
 IK Rating: IK07  
 Bug Rating: B1 U1 G0

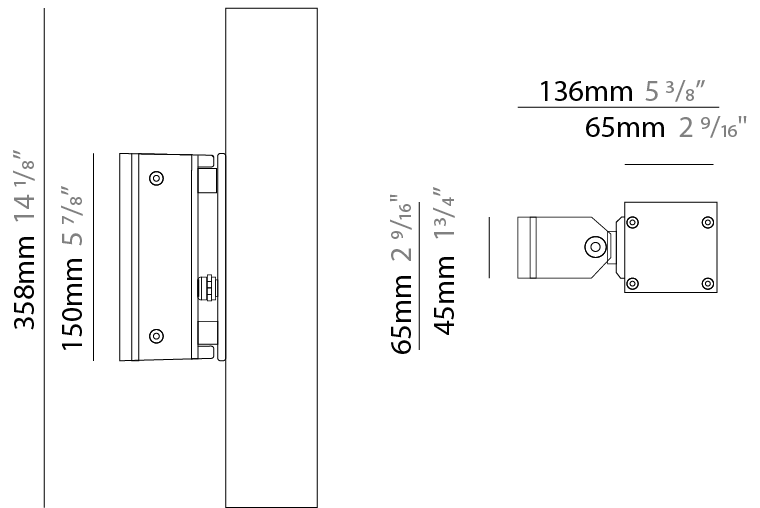
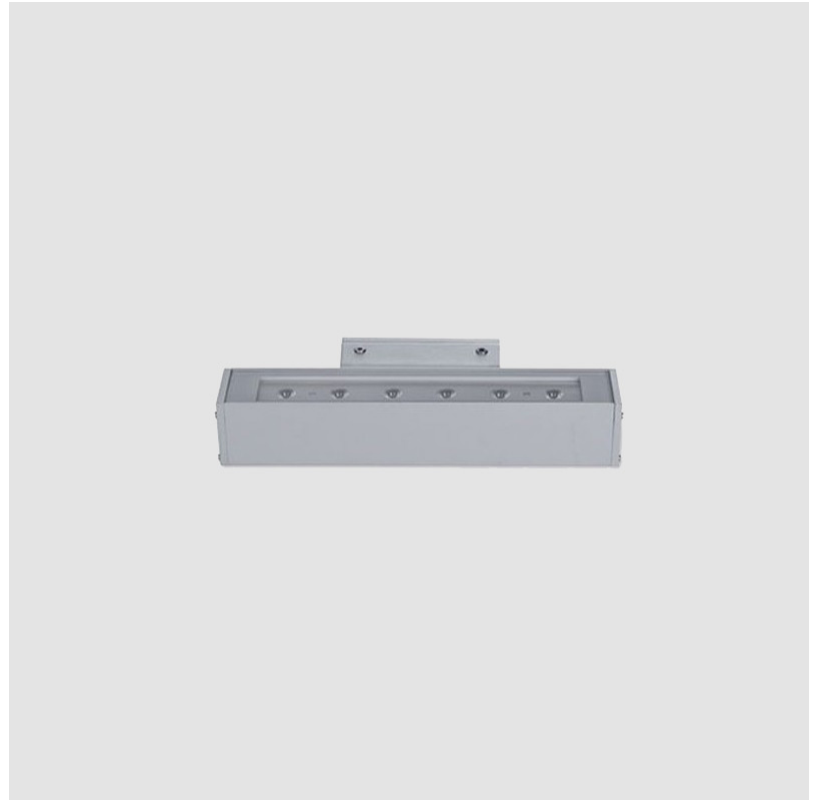

## TETRA LINEAR SURFACE

E9W189-

PROJECT

TYPE

SPECIFIER

QUANTITY

DATE

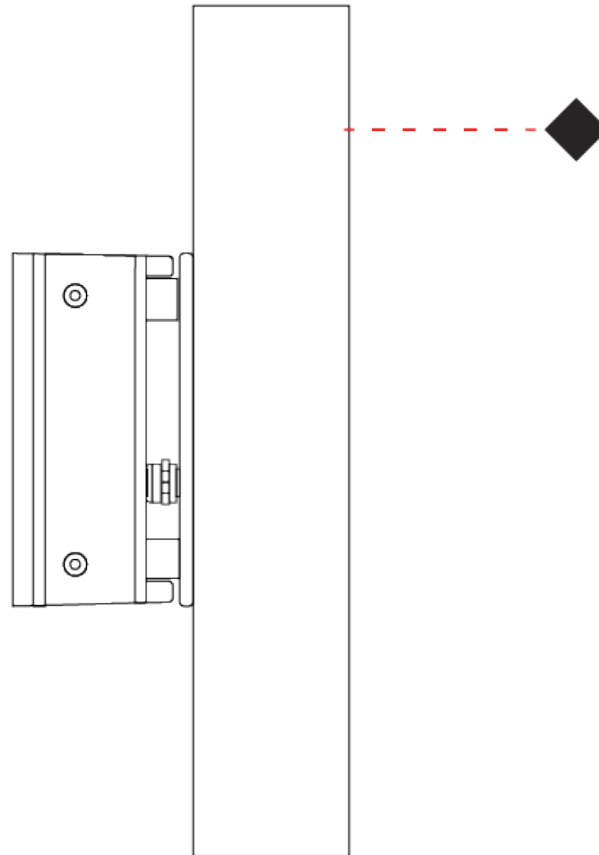

E

## TETRA LINEAR SURFACE

**E9W201-** - -  
 base number    Color    Finish    Lens  
                          Temperature    Options    Options

- To build a product code in our configurator select the specify button on the base model # product page
- To build a manual product code on this datasheet choose from the options listed below in blue font and add the suffix to the base model #

### GENERAL

Series: Tetra  
 Subseries: Tetra Linear  
 Brand: Platek  
 Division: Exterior  
 Mounting Type: Surface  
 Mounting Location: Wall  
 Subcategory: Wallwash

### PHYSICAL

Shape: Rectangle  
 Length (mm): 358  
 Length (in): 14 <sup>1</sup>/<sub>8</sub>  
 Width (mm): 65  
 Width (in): 2 <sup>9</sup>/<sub>16</sub>  
 Height (mm): 65  
 Depth (mm): 136  
 Height (in): 2 <sup>9</sup>/<sub>16</sub>  
 Depth (in): 5 <sup>3</sup>/<sub>8</sub>  
 Light Distribution: Adjustable / Direct  
 Weight (kg): 2.6  
 Weight (lbs): 5.73  
 Screws: A4 stainless steel  
 Diffuser: Clear tempered glass  
 Gasket: Gore-Tex valve to prevent condensation inside the fitting.  
 Fixture Finish: [BLK / WHI / GRY / COR / ANT / BRZ](#)  
 Fixture Material: Extruded Aluminum

### ELECTRICAL

Lamp Type: LED  
 Input Wattage (W): 13.5  
 Total Output Wattage (W): 12  
 Dimming: Non-Dimmable  
 Driver Included: Yes  
 Driver Location: Integrated  
 Driver Type: Constant Current - Universal  
 Driver Class: Class 2  
 Input Voltage (V): 120 - 277  
 Constant Current (MA): 350

### LED

Number of LEDs: 12  
 Color Temperature (°K): [3000 / 4000](#)  
 Max. Delivered Lumen (lm): 860 / 1020  
 Nominal Lumen (lm): 1680 / 1740  
 CRI: >80 CRI  
 Lamp Life (hrs): 60000

### OPTICAL

Optic°: [12 / 40 / Elliptical](#)  
 Adjustability: Tilt ±45°

### RATINGS AND CERTIFICATIONS

Certified By: Certified for North American Standards  
 IP rating: IP65  
 IK Rating: IK07  
 Bug Rating: B1 U1 G0

PROJECT \_\_\_\_\_  
 TYPE \_\_\_\_\_  
 SPECIFIER \_\_\_\_\_  
 QUANTITY \_\_\_\_\_  
 DATE \_\_\_\_\_

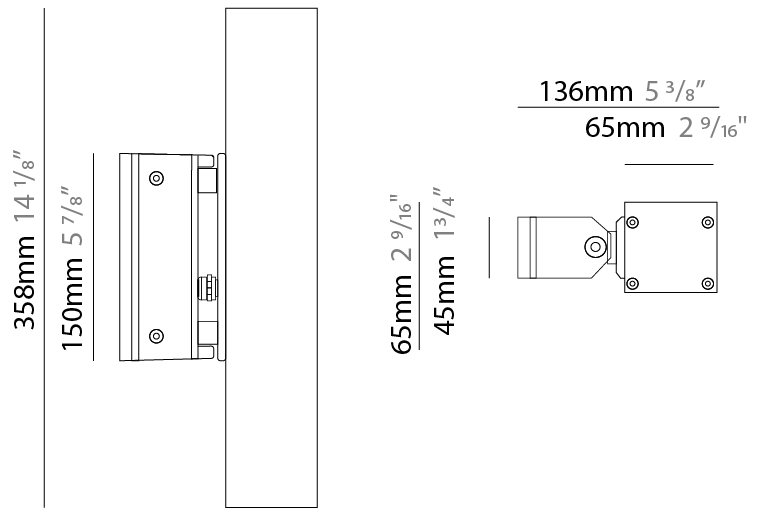
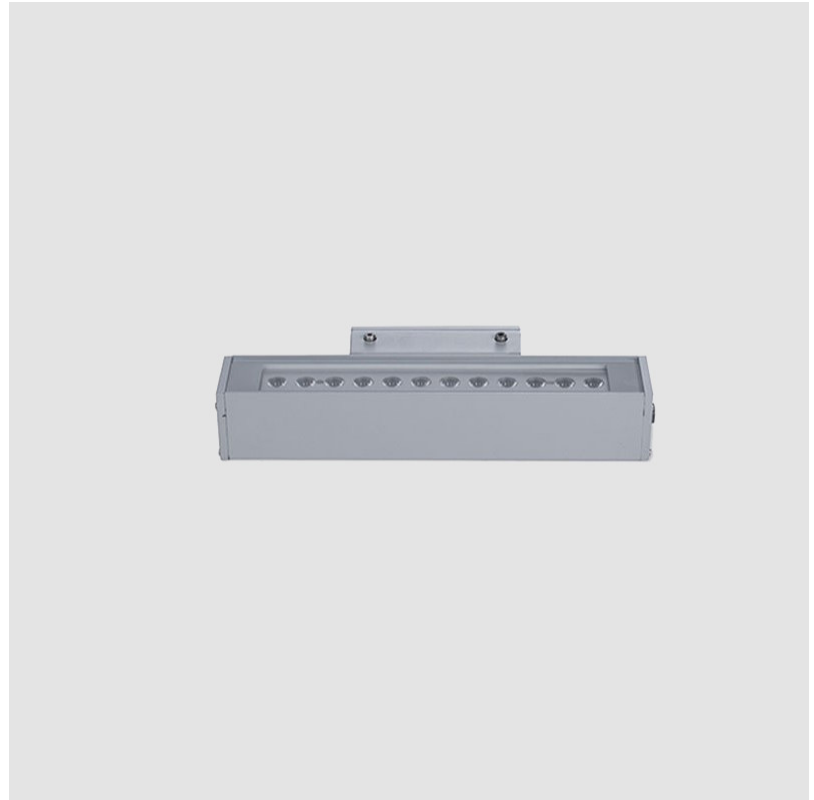

## TETRA LINEAR SURFACE

E9W201-

PROJECT

TYPE

SPECIFIER

QUANTITY

DATE

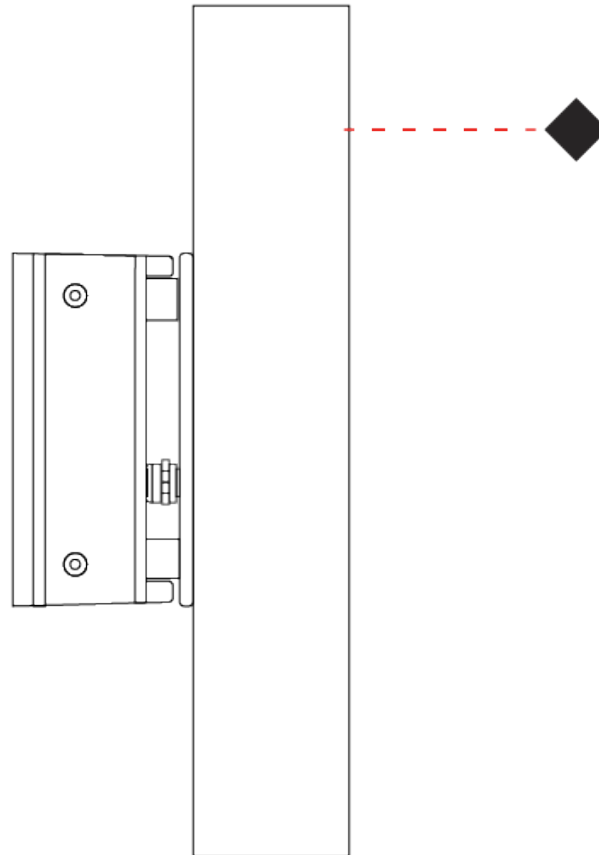

E

PROJECT
TYPE
SPECIFIER
QUANTITY
DATE

## TETRA CORNICHE SURFACE

**E9W215-** - -  
 base number    Color    Finish    Lens  
                          Temperature    Options    Options

- To build a product code in our configurator select the specify button on the base model # product page
- To build a manual product code on this datasheet choose from the options listed below in blue font and add the suffix to the base model #

### GENERAL

Series: Tetra  
 Subseries: Tetra Corniche  
 Brand: Platek  
 Division: Exterior  
 Mounting Type: Surface  
 Mounting Location: Wall  
 Subcategory: Wallwash

### PHYSICAL

Shape: Rectangle  
 Length (mm): 904  
 Length (in): 35 <sup>7</sup>/<sub>16</sub>"  
 Width (mm): 65  
 Width (in): 2 <sup>9</sup>/<sub>16</sub>"  
 Height (mm): 73  
 Height (in): 2 <sup>7</sup>/<sub>8</sub>"  
 Light Distribution: Adjustable / Direct  
 Weight (kg): 4  
 Weight (lbs): 8.8  
 Screws: A4 stainless steel  
 Diffuser: Clear tempered glass  
 Gasket: Gore-Tex valve to prevent condensation inside the fitting.  
 Fixture Finish: [BLK](#) / [WHI](#) / [GRY](#) / [COR](#) / [ANT](#) / [BRZ](#)  
 Fixture Material: Extruded Aluminum

### ELECTRICAL

Lamp Type: LED  
 Input Wattage (W): 21  
 Total Output Wattage (W): 18  
 Dimming: Non-Dimmable  
 Driver Included: Yes  
 Driver Location: Integrated  
 Driver Type: Constant Voltage - 120Vac  
 Driver Class: Class 2  
 Input Voltage (V): 120 - 277  
 Output Voltage (V): 24  
 Upon Request: (Not included - see components [IP65 or higher enclosure to be supplied by others]) Remote: Non-dimming 120/277Vac

### LED

Number of LEDs: 18  
 Color Temperature (°K): [3000](#) / [4000](#)  
 Max. Delivered Lumen (lm): 1300 / 1600  
 Nominal Lumen (lm): 2520 / 2610  
 CRI: >80 CRI  
 Lamp Life (hrs): 60000

### OPTICAL

Optic°: [13](#) / [26](#) / [40](#) / Elliptical  
 Pitch: 0-15° rotation angle

### RATINGS AND CERTIFICATIONS

Certified By: Certified for North American Standards  
 IP rating: IP66  
 IK Rating: IK07  
 Bug Rating: B2 U1 G0

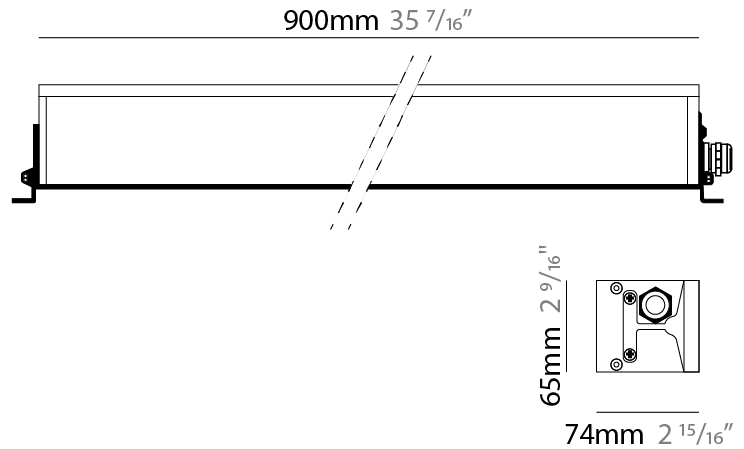

## TETRA CORNICHE SURFACE

E9W215-

PROJECT

TYPE

SPECIFIER

QUANTITY

DATE

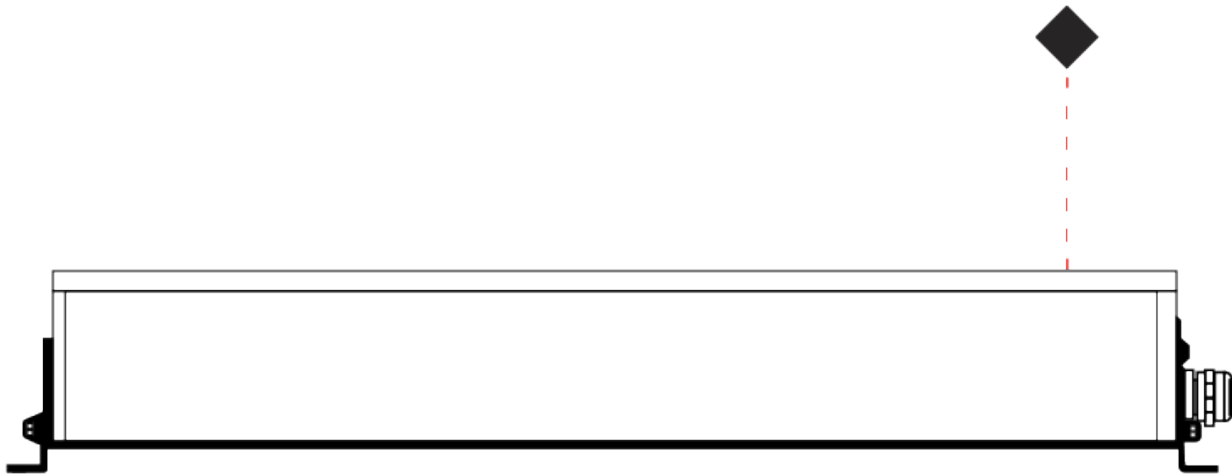

E

## TETRA CORNICHE SURFACE

### E9W231-

base number      Color      Finish      Lens  
 Temperature      Options      Options

- To build a product code in our configurator select the specify button on the base model # product page
- To build a manual product code on this datasheet choose from the options listed below in blue font and add the suffix to the base model #

#### GENERAL

Series: Tetra  
 Subseries: Tetra Corniche  
 Brand: Platek  
 Division: Exterior  
 Mounting Type: Surface  
 Mounting Location: Wall  
 Subcategory: Wallwash

#### PHYSICAL

Shape: Rectangle  
 Length (mm): 904  
 Length (in): 35 <sup>7</sup>/<sub>16</sub>  
 Height (mm): 73  
 Depth (mm): 65  
 Height (in): 2 <sup>7</sup>/<sub>8</sub>  
 Depth (in): 2 <sup>3</sup>/<sub>16</sub>  
 Light Distribution: Adjustable / Direct  
 Weight (kg): 5.2  
 Weight (lbs): 11.4  
 Screws: A4 stainless steel  
 Diffuser: Clear tempered glass  
 Gasket: Gore-Tex valve to prevent condensation inside the fitting.  
 Fixture Finish: [BLK](#) / [WHI](#) / [GRY](#) / [COR](#) / [ANT](#) / [BRZ](#)  
 Fixture Material: Extruded Aluminum

#### ELECTRICAL

Lamp Type: LED  
 Input Wattage (W): 47  
 Total Output Wattage (W): 36  
 Dimming: Non-Dimmable  
 Driver Included: Yes  
 Driver Location: Integrated  
 Driver Type: Constant Current - Universal  
 Driver Class: Class 2  
 Input Voltage (V): 120 - 277  
 Constant Current (MA): 350

#### LED

Number of LEDs: 36  
 Color Temperature (°K): [3000](#) / [4000](#)  
 Max. Delivered Lumen (lm): 2590 / 3220  
 Nominal Lumen (lm): 5040 / 5220  
 CRI: >80 CRI  
 Lamp Life (hrs): 60000

#### OPTICAL

Optic°: [13](#) / [26](#) / [40](#) / Elliptical  
 Pitch: 0-15° rotation angle

#### RATINGS AND CERTIFICATIONS

Certified By: Certified for North American Standards  
 IP rating: IP66  
 IK Rating: IK07  
 Bug Rating: B3 U1 G1

PROJECT
TYPE
SPECIFIER
QUANTITY
DATE

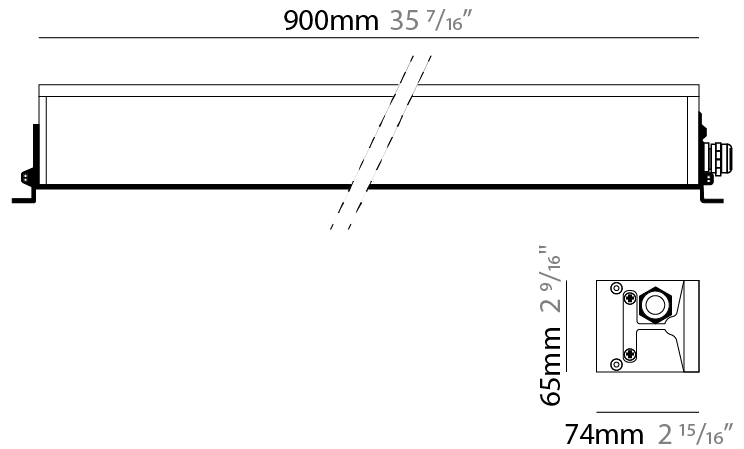



## TETRA CORNICHE SURFACE

E9W231-

PROJECT

TYPE

SPECIFIER

QUANTITY

DATE

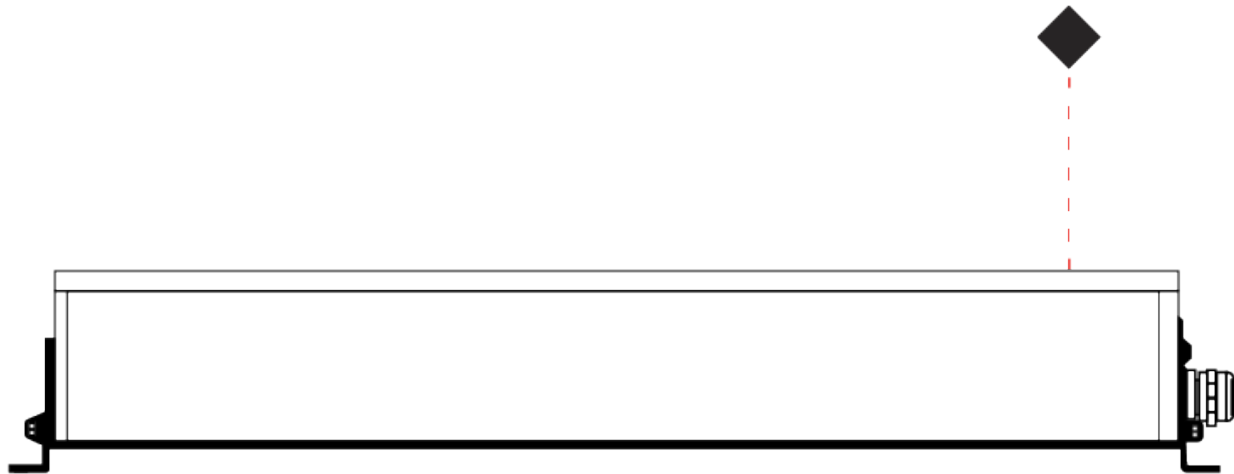

E

PROJECT	
TYPE	
SPECIFIER	
QUANTITY	
DATE	

## TETRA CORNICHE SURFACE

**E9W263-** - -  
 base number    Color    Finish    Lens  
                          Temperature    Options    Options

- To build a product code in our configurator select the specify button on the base model # product page
- To build a manual product code on this datasheet choose from the options listed below in blue font and add the suffix to the base model #

### GENERAL

Series: Tetra  
 Subseries: Tetra Corniche  
 Brand: Platek  
 Division: Exterior  
 Mounting Type: Surface  
 Mounting Location: Wall  
 Subcategory: Wallwash

### PHYSICAL

Shape: Rectangle  
 Length (mm): 358  
 Length (in): 14 <sup>7</sup>/<sub>8</sub>  
 Height (mm): 73  
 Depth (mm): 65  
 Height (in): 2 <sup>7</sup>/<sub>8</sub>  
 Depth (in): 2 <sup>3</sup>/<sub>16</sub>  
 Light Distribution: Adjustable / Direct  
 Weight (kg): 2.3  
 Weight (lbs): 5.1  
 Screws: A4 stainless steel  
 Diffuser: Clear tempered glass  
 Gasket: Gore-Tex valve to prevent condensation inside the fitting.  
 Fixture Finish: [BLK](#) / [WHI](#) / [GRY](#) / [COR](#) / [ANT](#) / [BRZ](#)  
 Fixture Material: Extruded Aluminum

### ELECTRICAL

Lamp Type: LED  
 Input Wattage (W): 13.5  
 Total Output Wattage (W): 12  
 Dimming: Non-Dimmable  
 Driver Included: Yes  
 Driver Location: Integrated  
 Driver Type: Constant Current - Universal  
 Driver Class: Class 2  
 Input Voltage (V): 120 - 277  
 Constant Current (MA): 350

### LED

Number of LEDs: 12  
 Color Temperature (°K): [3000](#) / [4000](#)  
 Max. Delivered Lumen (lm): 860 - 1070  
 Nominal Lumen (lm): 1680 / 1740  
 CRI: >80 CRI  
 Lamp Life (hrs): 60000

### OPTICAL

Optic°: [13](#) / [26](#) / [40](#) / Elliptical  
 Pitch: 0-15° rotation angle

### RATINGS AND CERTIFICATIONS

Certified By: Certified for North American Standards  
 IP rating: IP66  
 IK Rating: IK07  
 Bug Rating: B1 U1 G0

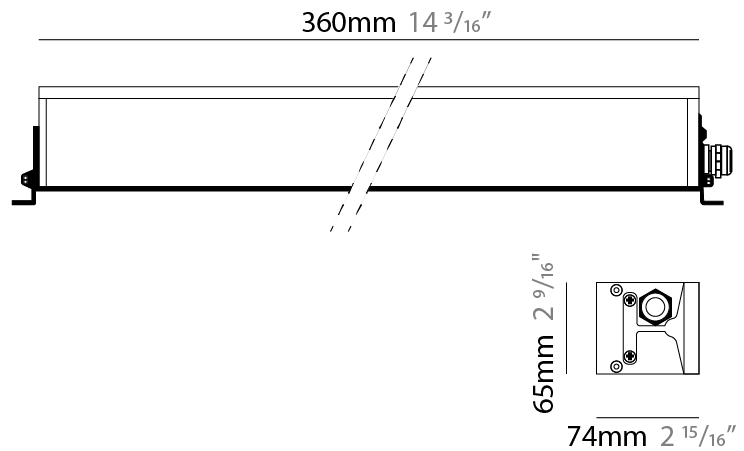

## TETRA CORNICHE SURFACE

E9W263-

PROJECT

TYPE

SPECIFIER

QUANTITY

DATE

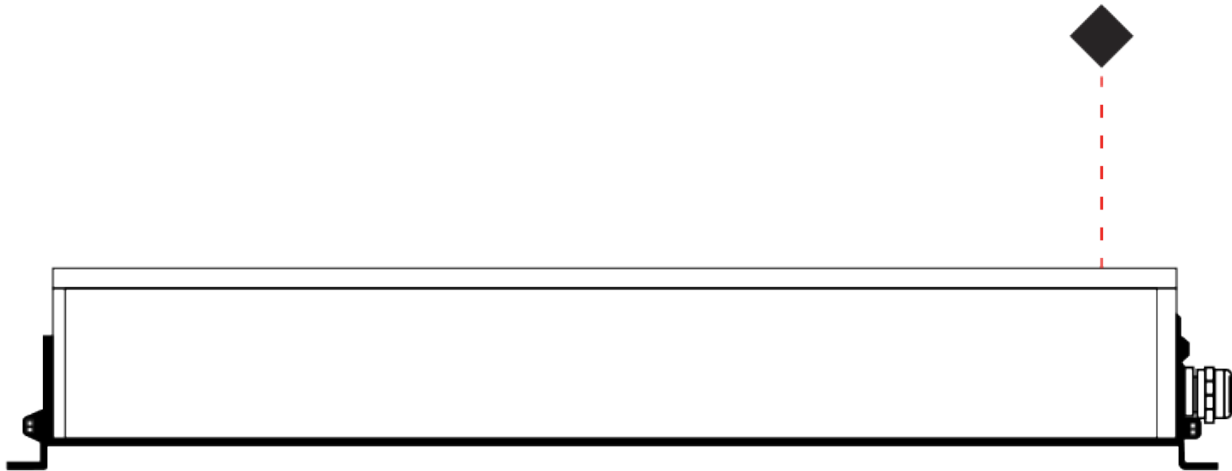

E

## TETRA APPLIQUE SURFACE

### E9W301-

base number    Color    Finish    Lens  
 Temperature    Options    Options

- To build a product code in our configurator select the specify button on the base model # product page
- To build a manual product code on this datasheet choose from the options listed below in blue font and add the suffix to the base model #

#### GENERAL

Series: Tetra  
 Subseries: Tetra Applique  
 Brand: Platek  
 Division: Exterior  
 Mounting Type: Surface  
 Mounting Location: Wall  
 Subcategory: Wall Effect

#### PHYSICAL

Shape: Rectangle  
 Length (mm): 36  
 Length (in): 1 7/16  
 Height (mm): 210  
 Depth (mm): 135  
 Height (in): 8 1/4  
 Depth (in): 5 5/16  
 Light Distribution: Direct  
 Weight (kg): 2  
 Weight (lbs): 4.4  
 Screws: A4 stainless steel  
 Diffuser: Clear tempered glass  
 Fixture Finish: [BLK](#) / [WHI](#) / [GRY](#) / [COR](#) / [ANT](#) / [BRZ](#)  
 Fixture Material: Extruded Aluminum

#### ELECTRICAL

Lamp Type: LED  
 Input Wattage (W): 3.9  
 Total Output Wattage (W): 3  
 Dimming: Non-Dimmable  
 Driver Included: Yes  
 Driver Location: Integrated  
 Driver Type: Constant Current - 120Vac  
 Driver Class: Class 2  
 Input Voltage (V): 120  
 Constant Current (MA): 350

#### LED

Color Temperature (°K): [3000](#) / [4000](#)  
 Max. Delivered Lumen (lm): 290 - 385  
 Nominal Lumen (lm): 420 / 435  
 CRI: >80 CRI  
 Lamp Life (hrs): 60000

#### OPTICAL

Optic°: [Single Emission](#)  
 Beam Angle: 13 / 44

#### RATINGS AND CERTIFICATIONS

Certified By: Certified for North American Standards  
 IP rating: IP65  
 IK Rating: IK07  
 Bug Rating: B1 U0 G0

PROJECT \_\_\_\_\_  
 TYPE \_\_\_\_\_  
 SPECIFIER \_\_\_\_\_  
 QUANTITY \_\_\_\_\_  
 DATE \_\_\_\_\_



135mm 5 5/16"

36mm 1 7/16"

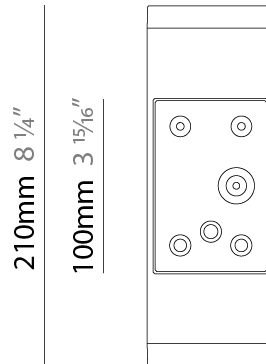
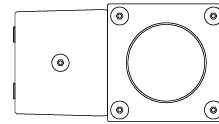

## TETRA APPLIQUE SURFACE

E9W301-

PROJECT

TYPE

SPECIFIER

QUANTITY

DATE

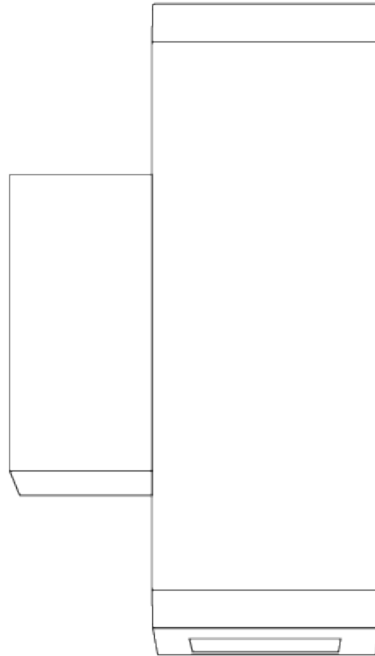

## TETRA APPLIQUE SURFACE

**E9W570-** - -  
 base number    Color    Finish    Lens  
                          Temperature    Options    Options

- To build a product code in our configurator select the specify button on the base model # product page
- To build a manual product code on this datasheet choose from the options listed below in blue font and add the suffix to the base model #

### GENERAL

Series: Tetra  
 Subseries: Tetra Applique  
 Brand: Platek  
 Division: Exterior  
 Mounting Type: Surface  
 Mounting Location: Wall  
 Subcategory: Wall Effect

### PHYSICAL

Shape: Rectangle  
 Length (mm): 36  
 Length (in): 1 7/16  
 Width (mm): 36  
 Width (in): 1 7/16  
 Height (mm): 210  
 Height (in): 8 1/4  
 Extension (mm): 135  
 Extension (in): 5 5/16  
 Light Distribution: Direct / Indirect  
 Weight (kg): 2.2  
 Weight (lbs): 4.8  
 Screws: A4 stainless steel  
 Diffuser: Clear tempered glass  
 Fixture Finish: BLK / WHI / GRY / COR / ANT / BRZ  
 Fixture Material: Extruded Aluminum

### ELECTRICAL

Lamp Type: LED  
 Input Wattage (W): 6.9  
 Total Output Wattage (W): 6  
 Dimming: Non-Dimmable  
 Driver Included: Yes  
 Driver Location: Integrated  
 Driver Type: Constant Current - 120Vac  
 Input Voltage (V): 120  
 Constant Current (MA): 350

### LED

Number of LEDs: 6  
 Color Temperature (°K): 3000 / 4000  
 Max. Delivered Lumen (lm): 740 / 770  
 Nominal Lumen (lm): 840 / 870  
 CRI: >80 CRI  
 Lamp Life (hrs): 60000

### OPTICAL

Optic°: Double Emission  
 Beam Angle: 2x12 / 2x44 / 12-44

### RATINGS AND CERTIFICATIONS

Certified By: Certified for North American Standards  
 IP rating: IP65  
 IK Rating: IK07  
 Bug Rating: B1 U3 G0

PROJECT
TYPE
SPECIFIER
QUANTITY
DATE



135mm 5 5/16"

36mm 1 7/16"

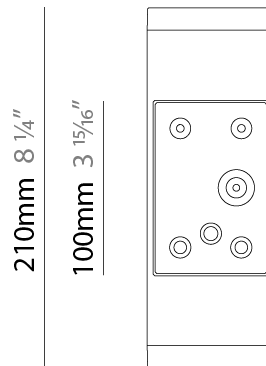
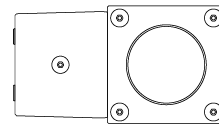

## TETRA APPLIQUE SURFACE

E9W570-

PROJECT

TYPE

SPECIFIER

QUANTITY

DATE

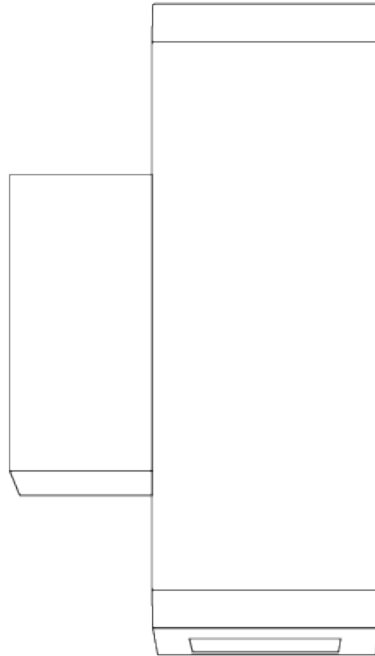

PROJECT	_____
TYPE	_____
SPECIFIER	_____
QUANTITY	_____
DATE	_____

### Fixture Finish

Black - BLK

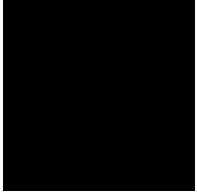

White - WHI

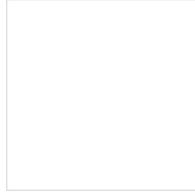

Gray - GRY

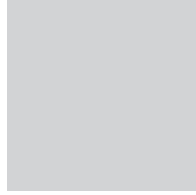

Corten - COR



Anthracite - ANT



Bronze - BRZ



Stainless Steel Inox - SST

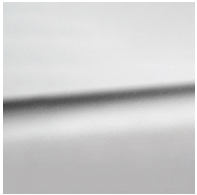

**Digital:** Not all screens are calibrated the same, and therefore, colors will appear differently between screens.

**Physical:** When texture is involved, there will be variations in color, character and tone within a product series and between product families.





PROJECT	
TYPE	
SPECIFIER	
QUANTITY	
DATE	

### LEGEND

floor-mounted	pivotal	special LED (upon request) RGB, RGBW, tunable, gold+, meat+, art+, fashion+
wall and ceiling: recessed and surface mounted	rotating	warm dim / natural dimming LED
ceiling-mounted and wall-mounted	illuminate tilted	rechargeable battery powered
wall-mounted	color of suspension cable	fixture with natural vivid LED (upon request)
omni-directional light distribution	length of suspension cable	color rendering index
direct light distribution	reflector degree selection	color temperature
direct/indirect light distribution	super spot	lumen (luminous flux)
indirect light distribution	lens	efficacy (lumens per watt)
asymmetric light distribution	lens pack	Unified Glare Rating (UGR) range from 5-40
aura light distribution	shine ring	marine grade (AISI 316 stainless steel)
round wall or ceiling cut-out	integrated shine ring with diffuser	walk on
square wall or ceiling cut-out	free individual colors 01-29	drive on
the supplied jig specifies the cutout dimensions	individual colors: 00 (free of charge), 01-25 (extra charge)	Dark Sky Compliance
minimum distance (meters) lamp - object	luminaire part to be colored (F1)	Americans with Disabilities Act (less than 4" off the wall located between 27"-84" from floor)
recessed depth	luminaire part to be colored (F2)	lamp protected against explosion
ceiling thickness in mm	luminaire part to be colored (F3)	blown glass using traditional methods by master glass blower
ceiling thickness selection	luminaire part to be colored (F4)	acoustic material
dimmable DP (phase), DV (0-10V), DD (dali), DS (step-dim)	luminaire part to be colored (F5)	protection class I, protection insulation
included or excluded LED driver/transformer/control gear	color of 3-circuit adaptor	protection class II, protection insulation
separately switchable	indirect diffuser	ETL Certified to UL and CSA Standards
sensor	direct diffuser	UL Certified to UL and CSA Standards
remote control	ball-proof (upon request)	CSA Certified to UL and CSA Standards
available upon request	accessory	Certified for North American Standards

### IP RATING

IP20	protected against ingress of solid bodies greater than 12.5mm (finger)
IP33	protected against ingress of solid bodies greater than 2.5mm protected against sprays of water up to 60 degrees from the vertical (rain)
IP40	protected against ingress of solid bodies greater than 1mm (wire) no protection against the ingress of moisture
IP43	protected against ingress of solid bodies greater than 1mm (wire) protected against sprays of water up to 60 degrees from the vertical (rain)
IP44	protected against ingress of solid bodies greater than 1mm (wire) protected against water splashed from all directions
IP54	protected against limited ingress of dust (wet rooms/covered outdoor areas) protected against water splashed from all directions
IP65	protected against ingress of dust protected against jets of water
IP66	protected against ingress of dust protected against powerful jets of water or heavy seas
IP67	protected against ingress of dust protected against immersion of water between 15cm - 1m for 30 minutes
IP68	protected against ingress of dust protected against immersion of water under pressure for long periods

### IK RATING

IK01	protected against 0.14 joules impact (equivalent to 0.25kg mass dropped from 56mm above the surface)
IK02	protected against 0.2 joules impact (equivalent to 0.25kg mass dropped from 80mm above the surface)
IK03	protected against 0.35 joules impact (equivalent to 0.25kg mass dropped from 140mm above the surface)
IK04	protected against 0.5 joules impact (equivalent to 0.25kg mass dropped from 200mm above the surface)
IK05	protected against 0.7 joules impact (equivalent to 0.25kg mass dropped from 280mm above the surface)
IK06	protected against 1 joules impact (equivalent to 0.25kg mass dropped from 400mm above the surface)
IK07	protected against 2 joules impact (equivalent to 0.5kg mass dropped from 400mm above the surface)
IK08	protected against 5 joules impact (equivalent to 1.7kg mass dropped from 300mm above the surface)
IK09	protected against 10 joules impact (equivalent to 5.0kg mass dropped from 200mm above the surface)
IK10	protected against 20 joules impact (equivalent to 5.0kg mass dropped from 400mm above the surface)