

## CALATHEA SUSPENSION

### D141238-

base number      Color      Finish      Finish  
 Temperature      Options      Options

- To build a product code in our configurator select the specify button on the base model # product page
- To build a manual product code on this datasheet choose from the options listed below in blue font and add the suffix to the base model #

#### GENERAL

Series: Vegetal  
 Subseries: Calathea  
 Partner: Cangini & Tucci  
 Division: Design  
 Installation: Suspension  
 Product Type: Pendant  
 Mounting Location: Ceiling

#### PHYSICAL

Shape: Abstract  
 Diameter (mm): 180  
 Diameter (in): 7 1/16  
 Height (mm): 220  
 Height (in): 8 11/16  
 Max. Overall Height (mm): 2220  
 Max. Overall Height (in): 87 3/8  
 Fixture Finish: AMB / GRN / PNK / RUB / SKB / SMK / TOB / TRA  
 Holder Finish: SGD / SBK  
 Fixture Material: Glass / Metal  
 Primary Material: Glass - Borosilicate  
 Cable Details: 2000mm Transparent cable

#### ELECTRICAL

Lamp Type: LED (Zhaga Standard)  
 Input Wattage (W): 4.2  
 Dimming: Non-Dimmable  
 Driver Included: Yes  
 Driver Location: Integrated  
 Driver Class: Class 2  
 Input Voltage (V): 120 - 277  
 Constant Current (mA): 350mA  
 Upon Request: Phase Dimming (120Vac only) / 0-10V Dimming

#### LED

Color Temperature (°K): 2700 / 3000  
 Nominal Lumen (lm): 460 / 500  
 CRI: >90 CRI  
 Lamp Life (hrs): 50000

#### OPTICAL

#### RATINGS AND CERTIFICATIONS

Certified By: Certified for North American Standards  
 IP rating: IP20

|           |
|-----------|
| PROJECT   |
| TYPE      |
| SPECIFIER |
| QUANTITY  |
| DATE      |

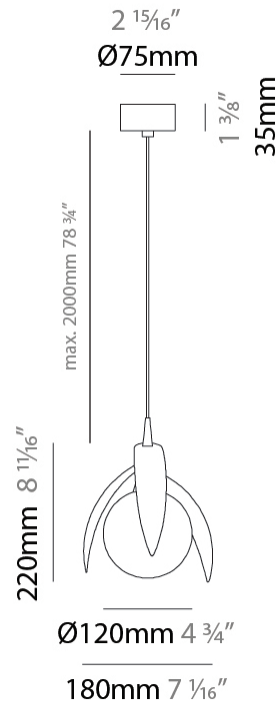

## CALATHEA SUSPENSION

D141238-

PROJECT \_\_\_\_\_

TYPE \_\_\_\_\_

SPECIFIER \_\_\_\_\_

QUANTITY \_\_\_\_\_

DATE \_\_\_\_\_

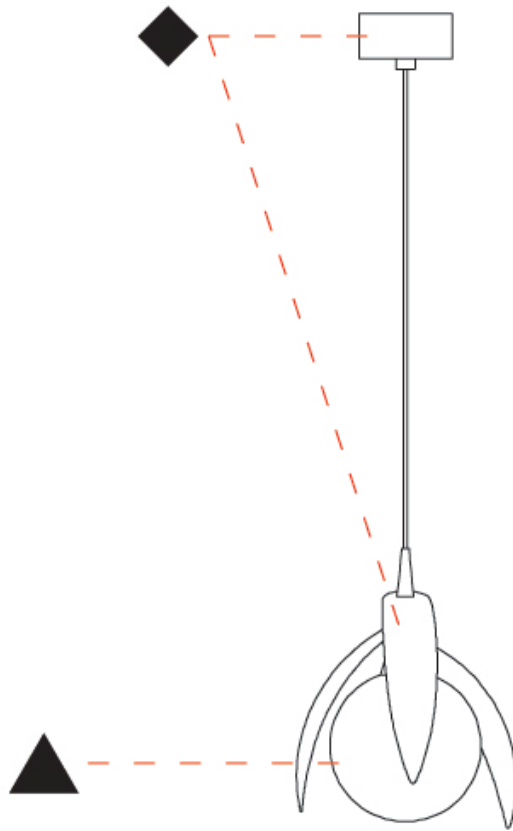

D

|           |
|-----------|
| PROJECT   |
| TYPE      |
| SPECIFIER |
| QUANTITY  |
| DATE      |

## FICUS SUSPENSION

### D141239-

base number      Color      Finish      Finish  
 Temperature      Options      Options

- To build a product code in our configurator select the specify button on the base model # product page
- To build a manual product code on this datasheet choose from the options listed below in blue font and add the suffix to the base model #

#### GENERAL

Series: Vegetal  
 Subseries: Ficus  
 Partner: Cangini & Tucci  
 Division: Design  
 Installation: Suspension  
 Product Type: Pendant  
 Mounting Location: Ceiling

#### PHYSICAL

Shape: Abstract  
 Diameter (mm): 180  
 Diameter (in): 7 1/16  
 Height (mm): 220  
 Height (in): 8 11/16  
 Max. Overall Height (mm): 2220  
 Max. Overall Height (in): 87 3/8  
 Fixture Finish: [AMB](#) / [GRN](#) / [PNK](#) / [RUB](#) / [SKB](#) / [SMK](#) / [TOB](#) / [TRA](#)  
 Holder Finish: SGD / SBK  
 Fixture Material: Glass / Metal  
 Primary Material: Glass - Borosilicate  
 Cable Details: 2000mm Transparent cable

#### ELECTRICAL

Lamp Type: LED (Zhaga Standard)  
 Input Wattage (W): 4.2  
 Dimming: Non-Dimmable  
 Driver Included: Yes  
 Driver Location: Integrated  
 Driver Class: Class 2  
 Input Voltage (V): 120 - 277  
 Constant Current (MA): 350mA  
 Upon Request: Phase Dimming (120Vac only) / 0-10V Dimming

#### LED

Color Temperature (°K): 2700 / 3000  
 Nominal Lumen (lm): 460 / 500  
 CRI: >90 CRI  
 Lamp Life (hrs): 50000

#### OPTICAL

#### RATINGS AND CERTIFICATIONS

Certified By: Certified for North American Standards  
 IP rating: IP20

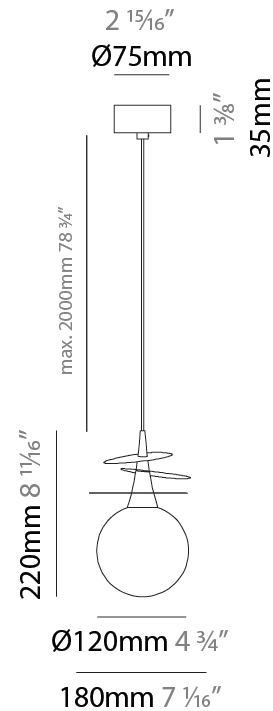

## FICUS SUSPENSION

D141239-

PROJECT

TYPE

SPECIFIER

QUANTITY

DATE

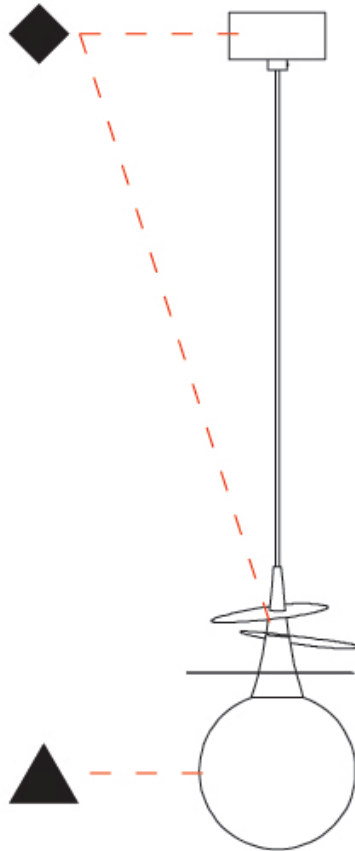

D

|           |
|-----------|
| PROJECT   |
| TYPE      |
| SPECIFIER |
| QUANTITY  |
| DATE      |

## PILEA SUSPENSION

### D141240-

base number    Color Temperature    Finish Options    Finish Options

- To build a product code in our configurator select the specify button on the base model # product page
- To build a manual product code on this datasheet choose from the options listed below in blue font and add the suffix to the base model #

#### GENERAL

Series: Vegetal  
 Subseries: Pilea  
 Partner: Cangini & Tucci  
 Division: Design  
 Installation: Suspension  
 Product Type: Pendant  
 Mounting Location: Ceiling

#### PHYSICAL

Shape: Abstract  
 Diameter (mm): 250  
 Diameter (in): 9 <sup>13</sup>/<sub>16</sub>  
 Height (mm): 220  
 Height (in): 8 <sup>11</sup>/<sub>16</sub>  
 Max. Overall Height (mm): 2220  
 Max. Overall Height (in): 87 <sup>3</sup>/<sub>8</sub>  
 Fixture Finish: AMB / GRN / PNK / RUB / SKB / SMK / TOB / TRA  
 Holder Finish: SGD / SBK  
 Fixture Material: Glass / Metal  
 Primary Material: Glass - Borosilicate  
 Cable Details: 2000mm Transparent cable

#### ELECTRICAL

Lamp Type: LED (Zhaga Standard)  
 Input Wattage (W): 4.2  
 Dimming: Non-Dimmable  
 Driver Included: Yes  
 Driver Location: Integrated  
 Driver Class: Class 2  
 Input Voltage (V): 120 - 277  
 Constant Current (mA): 350mA  
 Upon Request: Phase Dimming (120Vac only) / 0-10V Dimming

#### LED

Color Temperature (°K): 2700 / 3000  
 Nominal Lumen (lm): 460 / 500  
 CRI: >90 CRI  
 Lamp Life (hrs): 50000

#### OPTICAL

#### RATINGS AND CERTIFICATIONS

Certified By: Certified for North American Standards  
 IP rating: IP20

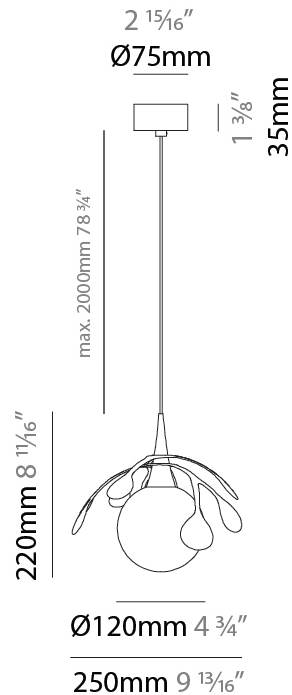

## PILEA SUSPENSION

D141240-

PROJECT

TYPE

SPECIFIER

QUANTITY

DATE

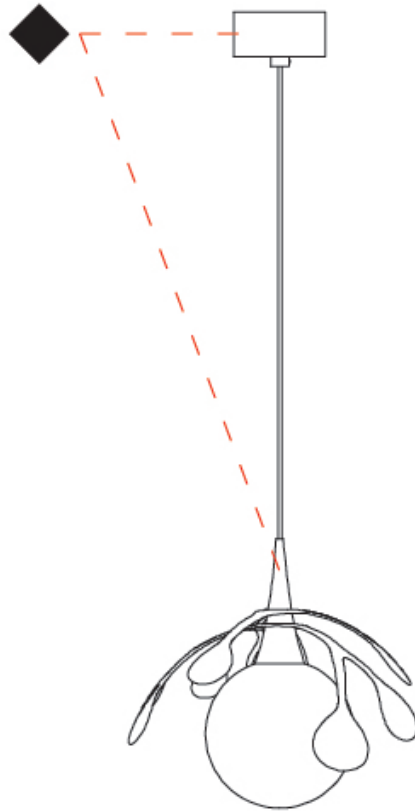

D

## PALMA SUSPENSION

### D141241-

base number      Color      Finish      Finish  
 Temperature      Options      Options

- To build a product code in our configurator select the specify button on the base model # product page
- To build a manual product code on this datasheet choose from the options listed below in blue font and add the suffix to the base model #

#### GENERAL

Series: Vegetal  
 Subseries: Palma  
 Partner: Cangini & Tucci  
 Division: Design  
 Installation: Suspension  
 Product Type: Pendant  
 Mounting Location: Ceiling

#### PHYSICAL

Shape: Abstract  
 Diameter (mm): 450  
 Diameter (in): 17 11/16  
 Height (mm): 1000  
 Height (in): 39 3/8  
 Max. Overall Height (mm): 3000  
 Max. Overall Height (in): 118 3/8  
 Fixture Finish: AMB / GRN / PNK / RUB / SKB / SMK / TOB / TRA  
 Holder Finish: SGD / SBK  
 Fixture Material: Glass / Metal  
 Primary Material: Glass - Borosilicate  
 Cable Details: 2000mm Transparent cable

#### ELECTRICAL

Lamp Type: LED (Zhaga Standard)  
 Input Wattage (W): 6  
 Dimming: Non-Dimmable  
 Driver Included: Yes  
 Driver Location: Integrated  
 Driver Class: Class 2  
 Input Voltage (V): 120 - 277  
 Constant Current (MA): 500mA

#### LED

Color Temperature (°K): 2700 / 3000  
 Nominal Lumen (lm): 866  
 CRI: >90 CRI  
 Lamp Life (hrs): 50000

#### OPTICAL

#### RATINGS AND CERTIFICATIONS

Certified By: Certified for North American Standards  
 IP rating: IP20

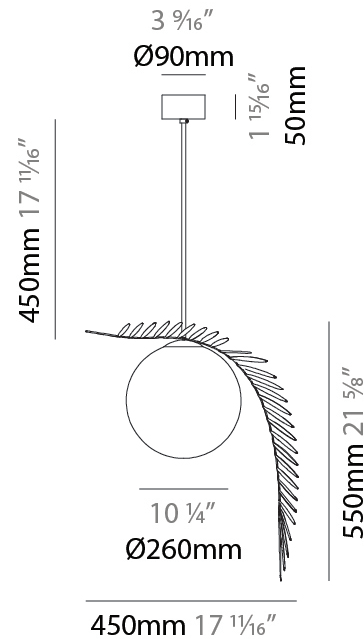

## PALMA SUSPENSION

D141241-

|           |       |
|-----------|-------|
| PROJECT   | _____ |
| TYPE      | _____ |
| SPECIFIER | _____ |
| QUANTITY  | _____ |
| DATE      | _____ |

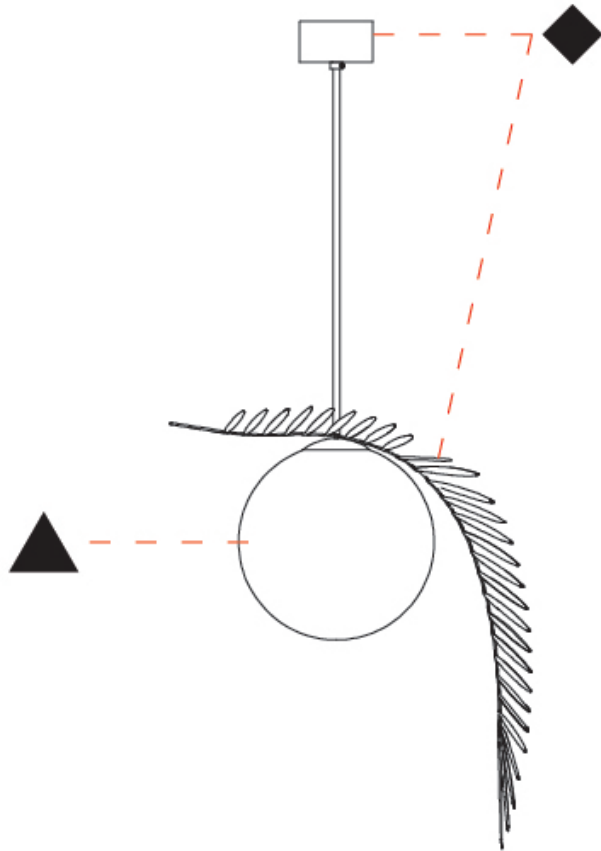

D

|           |
|-----------|
| PROJECT   |
| TYPE      |
| SPECIFIER |
| QUANTITY  |
| DATE      |

## VEGETAL - 7 LIGHT LINEAR SUSPENSION

### D141265-

|             |                   |                |                |                |
|-------------|-------------------|----------------|----------------|----------------|
| base number | Color Temperature | Finish Options | Finish Options | Finish Options |
|-------------|-------------------|----------------|----------------|----------------|

- To build a product code in our configurator select the specify button on the base model # product page
- To build a manual product code on this datasheet choose from the options listed below in blue font and add the suffix to the base model #

#### GENERAL

|                                     |
|-------------------------------------|
| Series: Vegetal                     |
| Subseries: Vegetal - 7 Light Linear |
| Partner: Cangini & Tucci            |
| Division: Design                    |
| Installation: Suspension            |
| Product Type: Pendant               |
| Mounting Location: Ceiling          |

#### PHYSICAL

|   |
|---|
| Shape: Abstract   |
| Length (mm): 1300   |
| Length (in): 51 <sup>3</sup> / <sub>16</sub>  |
| Width (mm): 400   |
| Width (in): 15 <sup>3</sup> / <sub>4</sub>  |
| Height (mm): 220  |
| Height (in): 8 <sup>11</sup> / <sub>16</sub>  |
| Max. Overall Height (mm): 2220  |
| Max. Overall Height (in): 87 <sup>3</sup> / <sub>8</sub>  |
| Fixture Finish: <a href="#">AMB</a> / <a href="#">GRN</a> / <a href="#">PNK</a> / <a href="#">RUB</a> / <a href="#">SKB</a> / <a href="#">SMK</a> / <a href="#">TOB</a> / <a href="#">TRA</a> |
| Holder Finish: <a href="#">SGD</a> / <a href="#">SBK</a>  |
| Accent Finish: <a href="#">CHR</a> / <a href="#">MWH</a> / <a href="#">MBK</a> / <a href="#">BCR</a>  |
| Fixture Material: Glass / Metal   |
| Primary Material: Glass - Borosilicate  |
| Cable Details: 2000mm Transparent cable   |

#### ELECTRICAL

|   |
|---|
| Lamp Type: LED (Zhaga Standard)                           |
| Input Wattage (W): 29.4                                   |
| Dimming: Non-Dimmable                                     |
| Driver Included: Yes                                      |
| Driver Location: Integrated                               |
| Driver Class: Class 2                                     |
| Input Voltage (V): 120 - 277                              |
| Constant Current (MA): 350mA                              |
| Upon Request: Phase Dimming (120Vac only) / 0-10V Dimming |

#### LED

|   |
|---|
| Color Temperature (°K): <a href="#">2700</a> / <a href="#">3000</a> |
| Nominal Lumen (lm): 3220 / 3500                                     |
| CRI: >90 CRI  |
| Lamp Life (hrs): 50000  |

#### OPTICAL

#### RATINGS AND CERTIFICATIONS

|  |
|--|
| Certified By: Certified for North American Standards |
| IP rating: IP20                                      |

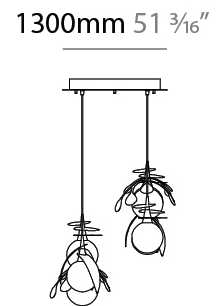
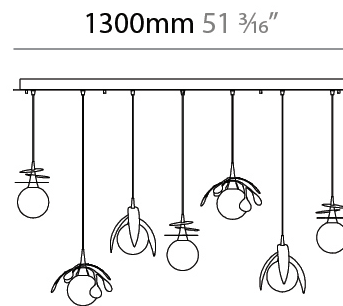

## VEGETAL - 7 LIGHT LINEAR SUSPENSION

D141265-

|           |       |
|-----------|-------|
| PROJECT   | _____ |
| TYPE      | _____ |
| SPECIFIER | _____ |
| QUANTITY  | _____ |
| DATE      | _____ |

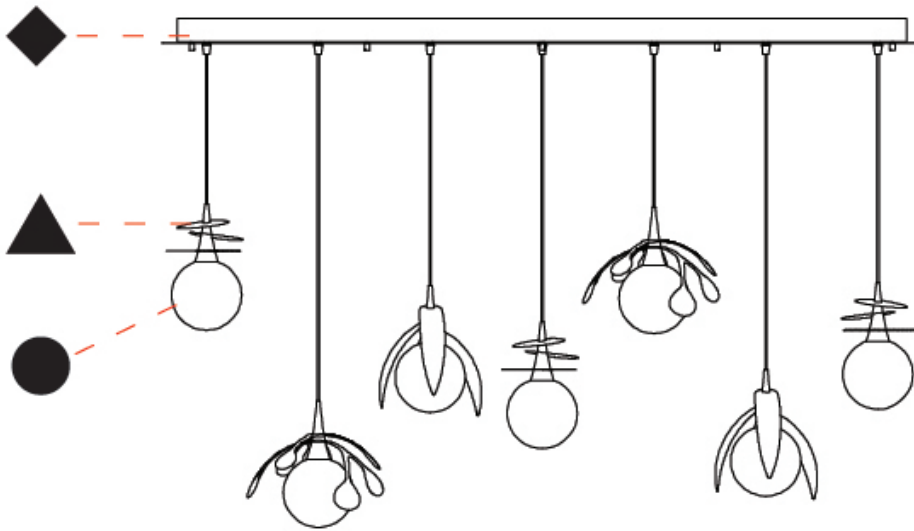

D

|           |
|-----------|
| PROJECT   |
| TYPE      |
| SPECIFIER |
| QUANTITY  |
| DATE      |

## VEGETAL - 3 LIGHT CLUSTER SUSPENSION

### D141266-

|             |                      |                   |                   |                   |
|-------------|----------------------|-------------------|-------------------|-------------------|
| base number | Color<br>Temperature | Finish<br>Options | Finish<br>Options | Finish<br>Options |
|-------------|----------------------|-------------------|-------------------|-------------------|

- To build a product code in our configurator select the specify button on the base model # product page
- To build a manual product code on this datasheet choose from the options listed below in blue font and add the suffix to the base model #

#### GENERAL

|                                      |
|--------------------------------------|
| Series: Vegetal                      |
| Subseries: Vegetal - 3 Light Cluster |
| Partner: Cangini & Tucci             |
| Division: Design                     |
| Installation: Suspension             |
| Product Type: Pendant                |
| Mounting Location: Ceiling           |

#### PHYSICAL

|   |
|---|
| Shape: Abstract   |
| Diameter (mm): 430  |
| Diameter (in): 16 <sup>15</sup> / <sub>16</sub>   |
| Height (mm): 220  |
| Height (in): 8 <sup>11</sup> / <sub>16</sub>  |
| Max. Overall Height (mm): 2220  |
| Max. Overall Height (in): 87 <sup>3</sup> / <sub>8</sub>  |
| Fixture Finish: <a href="#">AMB</a> / <a href="#">GRN</a> / <a href="#">PNK</a> / <a href="#">RUB</a> / <a href="#">SKB</a> / <a href="#">SMK</a> / <a href="#">TOB</a> / <a href="#">TRA</a> |
| Holder Finish: SGD / SBK  |
| Accent Finish: CHR / MWH / MBK / BCR  |
| Fixture Material: Glass / Metal   |
| Primary Material: Glass - Borosilicate  |
| Cable Details: 2000mm Transparent cable   |

#### ELECTRICAL

|   |
|---|
| Lamp Type: LED (Zhaga Standard)                           |
| Input Wattage (W): 12.6                                   |
| Dimming: Non-Dimmable                                     |
| Driver Included: Yes                                      |
| Driver Location: Integrated                               |
| Driver Class: Class 2                                     |
| Input Voltage (V): 120 - 277                              |
| Constant Current (MA): 500mA                              |
| Upon Request: Phase Dimming (120Vac only) / 0-10V Dimming |

#### LED

|                                     |
|-------------------------------------|
| Color Temperature (°K): 2700 / 3000 |
| Nominal Lumen (lm): 1380 / 1500     |
| CRI: >90 CRI                        |
| Lamp Life (hrs): 50000              |

#### OPTICAL

#### RATINGS AND CERTIFICATIONS

|  |
|--|
| Certified By: Certified for North American Standards |
| IP rating: IP20                                      |

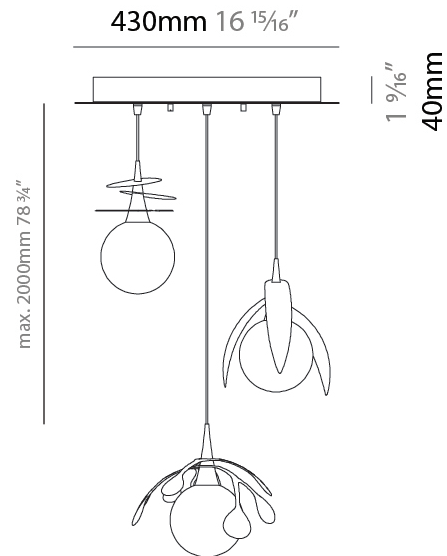

## VEGETAL - 3 LIGHT CLUSTER SUSPENSION

D141266-

PROJECT

TYPE

SPECIFIER

QUANTITY

DATE

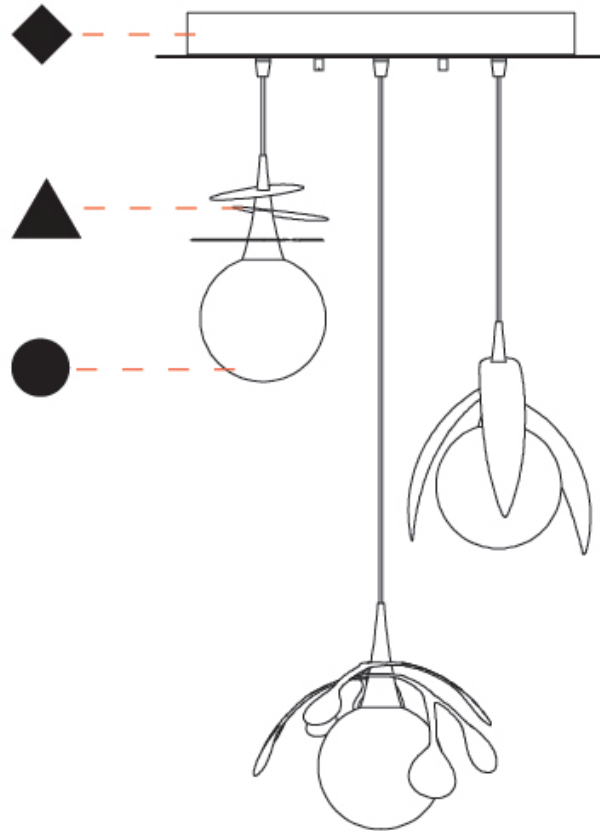

|           |
|-----------|
| PROJECT   |
| TYPE      |
| SPECIFIER |
| QUANTITY  |
| DATE      |

## VEGETAL - 3 LIGHT LINEAR SUSPENSION

### D141267-

base number      Color      Finish      Finish      Finish  
 Temperature      Options      Options      Options

- To build a product code in our configurator select the specify button on the base model # product page
- To build a manual product code on this datasheet choose from the options listed below in blue font and add the suffix to the base model #

#### GENERAL

Series: Vegetal  
 Subseries: Vegetal - 3 Light Linear  
 Partner: Cangini & Tucci  
 Division: Design  
 Installation: Suspension  
 Product Type: Pendant  
 Mounting Location: Ceiling

#### PHYSICAL

Shape: Abstract  
 Length (mm): 900  
 Length (in): 35 7/16  
 Height (mm): 220  
 Height (in): 8 11/16  
 Max. Overall Height (mm): 2220  
 Max. Overall Height (in): 87 3/8  
 Fixture Finish: AMB / GRN / PNK / RUB / SKB / SMK / TOB / TRA  
 Holder Finish: SGD / SBK  
 Accent Finish: CHR / MWH / MBK / BCR  
 Fixture Material: Glass / Metal  
 Primary Material: Glass - Borosilicate  
 Cable Details: 2000mm Transparent cable

#### ELECTRICAL

Lamp Type: LED (Zhaga Standard)  
 Input Wattage (W): 12.6  
 Dimming: Non-Dimmable  
 Driver Included: Yes  
 Driver Location: Integrated  
 Driver Class: Class 2  
 Input Voltage (V): 120 - 277  
 Constant Current (MA): 350mA  
 Upon Request: Phase Dimming (120Vac only) / 0-10V Dimming

#### LED

Color Temperature (°K): 2700 / 3000  
 Nominal Lumen (lm): 1380 / 1500  
 CRI: >90 CRI  
 Lamp Life (hrs): 50000

#### OPTICAL

#### RATINGS AND CERTIFICATIONS

Certified By: Certified for North American Standards  
 IP rating: IP20

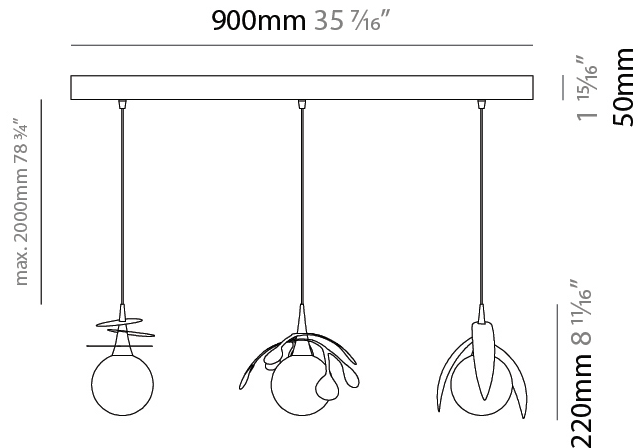

## VEGETAL - 3 LIGHT LINEAR SUSPENSION

D141267-

|           |       |
|-----------|-------|
| PROJECT   | _____ |
| TYPE      | _____ |
| SPECIFIER | _____ |
| QUANTITY  | _____ |
| DATE      | _____ |

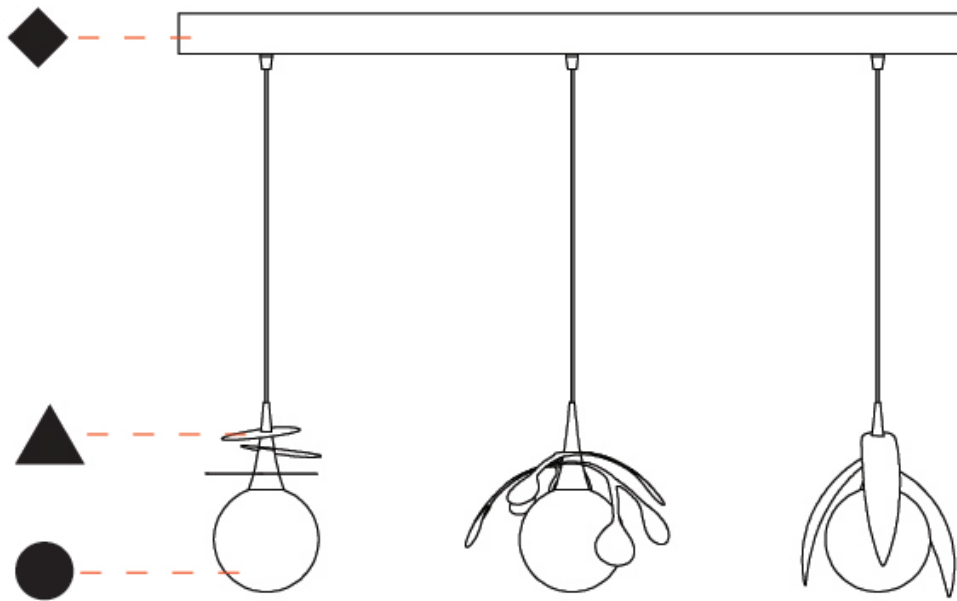

D

## VEGETAL COLOR FINISH CHART

|           |       |
|-----------|-------|
| PROJECT   | _____ |
| TYPE      | _____ |
| SPECIFIER | _____ |
| QUANTITY  | _____ |
| DATE      | _____ |

### Fixture Finish

Amber - AMB



Green - GRN



Pink - PNK



Ruby - RUB



Sky Blue - SKB



Smoke - SMK



Tobacco - TOB



Transparent - TRA



### Holder Finish

Satin Gold - SGD



Satin Black Nickel - SBK



## CALATHEA, FICUS, PALMA, PILEA, VEGETAL - 3 LIGHT CLUSTER, VEGETAL - 3 LIGHT LINEAR, VEGETAL - 7 LIGHT LINEAR SUSPENSION

### COLOR FINISH CHART

#### Accent Finish

Chrome - CHR

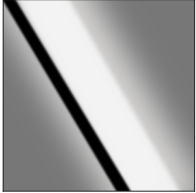

Matte White - MWH



Matte Black - MBK

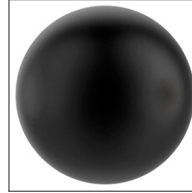

Brushed Chrome - BCR

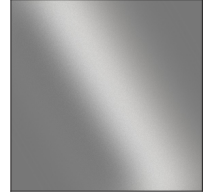

**Digital:** Not all screens are calibrated the same, and therefore, colors will appear differently between screens.

**Physical:** When texture is involved, there will be variations in color, character and tone within a product series and between product families.













### LEGEND

|  |  |  |
|--|--|--|
|  floor-mounted   |  pivotable  |  special LED (upon request) RGB, RGBW, tunable, gold+, meat+, art+, fashion+                    |
|  wall and ceiling: recessed and surface mounted              |  rotating   |  warm dim / natural dimming LED   |
|  ceiling-mounted and wall-mounted                            |  illuminate tilted  |  rechargeable battery powered   |
|  wall-mounted  |  color of suspension cable                                    |  fixture with natural vivid LED (upon request)  |
|  omni-directional light distribution                         |  length of suspension cable                                   |  color rendering index  |
|  direct light distribution                                   |  reflector degree selection                                   |  color temperature  |
|  direct/indirect light distribution                          |  super spot   |  lumen (luminous flux)  |
|  indirect light distribution                                 |  lens   |  efficacy (lumens per watt)   |
|  asymmetric light distribution                               |  lens pack  |  Unified Glare Rating (UGR) range from 5-40   |
|  aura light distribution                                     |  shine ring   |  marine grade (AISI 316 stainless steel)  |
|  round wall or ceiling cut-out                               |  integrated shine ring with diffuser                          |  walk on  |
|  square wall or ceiling cut-out                              |  free individual colors 01-29                                 |  drive on   |
|  the supplied jig specifies the cutout dimensions            |  individual colors: 00 (free of charge), 01-25 (extra charge) |  Dark Sky Compliance  |
|  minimum distance (meters) lamp - object                     |  luminaire part to be colored (F1)                            |  Americans with Disabilities Act (less than 4" off the wall located between 27"-84" from floor) |
|  recessed depth  |  luminaire part to be colored (F2)                            |  lamp protected against explosion   |
|  ceiling thickness in mm                                    |  luminaire part to be colored (F3)                           |  blown glass using traditional methods by master glass blower                                  |
|  ceiling thickness selection                               |  luminaire part to be colored (F4)                          |  acoustic material  |
|  dimmable DP (phase), DV (0-10V), DD (dali), DS (step-dim) |  luminaire part to be colored (F5)                          |  protection class I, protection insulation  |
|  included or excluded LED driver/transformer/control gear  |  color of 3-circuit adaptor                                 |  protection class II, protection insulation   |
|  separately switchable                                     |  indirect diffuser  |  ETL Certified to UL and CSA Standards  |
|  sensor  |  direct diffuser  |  UL Certified to UL and CSA Standards   |
|  remote control  |  ball-proof (upon request)                                  |  CSA Certified to UL and CSA Standards  |
|  available upon request                                    |  accessory  |  Certified for North American Standards   |

### IP RATING

|  |  |
|--|--|
|  IP20 | protected against ingress of solid bodies greater than 12.5mm (finger)   |
|  IP33 | protected against ingress of solid bodies greater than 2.5mm<br>protected against sprays of water up to 60 degrees from the vertical (rain)      |
|  IP40 | protected against ingress of solid bodies greater than 1mm (wire)<br>no protection against the ingress of moisture                               |
|  IP43 | protected against ingress of solid bodies greater than 1mm (wire)<br>protected against sprays of water up to 60 degrees from the vertical (rain) |
|  IP44 | protected against ingress of solid bodies greater than 1mm (wire)<br>protected against water splashed from all directions                        |
|  IP54 | protected against limited ingress of dust (wet rooms/covered outdoor areas)<br>protected against water splashed from all directions              |
|  IP65 | protected against ingress of dust<br>protected against jets of water   |
|  IP66 | protected against ingress of dust<br>protected against powerful jets of water or heavy seas  |
|  IP67 | protected against ingress of dust<br>protected against immersion of water between 15cm - 1m for 30 minutes                                       |
|  IP68 | protected against ingress of dust<br>protected against immersion of water under pressure for long periods  |

### IK RATING

|  |   |
|--|---|
|  IK01 | protected against 0.14 joules impact (equivalent to 0.25kg mass dropped from 56mm above the surface)  |
|  IK02 | protected against 0.2 joules impact (equivalent to 0.25kg mass dropped from 80mm above the surface)   |
|  IK03 | protected against 0.35 joules impact (equivalent to 0.25kg mass dropped from 140mm above the surface) |
|  IK04 | protected against 0.5 joules impact (equivalent to 0.25kg mass dropped from 200mm above the surface)  |
|  IK05 | protected against 0.7 joules impact (equivalent to 0.25kg mass dropped from 280mm above the surface)  |
|  IK06 | protected against 1 joules impact (equivalent to 0.25kg mass dropped from 400mm above the surface)    |
|  IK07 | protected against 2 joules impact (equivalent to 0.5kg mass dropped from 400mm above the surface)     |
|  IK08 | protected against 5 joules impact (equivalent to 1.7kg mass dropped from 300mm above the surface)     |
|  IK09 | protected against 10 joules impact (equivalent to 5.0kg mass dropped from 200mm above the surface)    |
|  IK10 | protected against 20 joules impact (equivalent to 5.0kg mass dropped from 400mm above the surface)    |